

Electricity Industry Participation Code 2010

Contents

**Part 1
Preliminary provisions**

**Part 2
Availability of information**

**Part 3
Market operation service providers**

**Part 4
Force majeure provisions relating to ancillary service agents**

**Part 5
Regime for dealing with undesirable trading situations**

**Part 6
Connection of distributed generation**

**Part 6A
Separation of distribution from certain generation and
retailing**

**Part 7
System operator**

**Part 8
Common quality**

**Part 9
Security of supply**

**Part 10
Metering**

**Part 11
Registry information management**

**Part 12
Transport**

**Part 12A
Distributor agreements, arrangements, and other provisions**

Part 13
Trading arrangements

Part 14
Clearing and Settlement

Part 14A
Prudential requirements

Part 15
Reconciliation

Part 16
Special provisions relating to Rio Tinto agreements *[Revoked]*

Part 16A
Audits

Part 17
Transitional provisions

Code

1 Title

This Code is the Electricity Industry Participation Code 2010.

2 Commencement

In accordance with section 36(1) of the Act, this Code comes into force on 1 November 2010.

Electricity Industry Participation Code 2010

Part 1 Preliminary provisions

Contents

- 1.1 Interpretation
- 1.2 General principles of construction
- 1.3 Special definition of “related”
- 1.4 Special definition of “independent”
- 1.5 Special definition of “purchaser” and “participant”
- 1.5A Application of Code to distributors
- 1.6 Contents tables
- 1.7 Defined terms appear in bold

Schedule 1.1

Notice of assumption of rights and obligations under Parts 8, 13, 14, and 14A of the Electricity Industry Participation Code 2010

Schedule 1.2

Revocation of notice of assumption of rights and obligations under Parts 8, 13, 14, and 14A of the Electricity Industry Participation Code 2010

1.1 Interpretation

- (1) In this Code, unless the context otherwise requires,—

Act means the Electricity Industry Act 2010

active energy means the integration over time of the product of voltage, current and the cosine of the phase angle between them, and which is normally measured in kilowatt hours (kWh)

active meter means a **meter** used for the measurement of **active energy**

active power means the product of voltage, current and the cosine of the phase angle between them, and which is normally measured in kilowatts (kW)

additional customer compensation scheme means a scheme operated by a **retailer** under clause 9.26, in addition to the **retailer’s default customer compensation scheme**
Clause 1.1(1) **additional customer compensation scheme**: inserted, on 1 April 2011, by clause 4(1) of the Electricity Industry Participation (Customer Compensation Schemes) Code Amendment 2011.

adjustment means, for the purposes of the definitions of **error compensation**, **loss compensation**, and Part 10, an operation or process intended to reduce the differences between the values indicated by an instrument and the values realised by a **reference standard** or **working standard** to within a predetermined tolerance, and **adjust** and **adjusted** have corresponding meanings

Clause 1.1(1) **adjustment**: amended, on 29 August 2013, by clause 4(1) of the Electricity Industry Participation (Metering Arrangements) Code Amendment 2013.

adjustment clause means a clause in a **contract for differences** or a **fixed-price physical supply contract** under which the price or prices of a specified volume of **electricity** may be adjusted, including an adjustment relating to the Consumer Price Index, the Producers Price Index or any other index

administrative cost means, in relation to an **ancillary service**, the significant costs that are incurred by the **system operator** in relation to the development of **ancillary service** provision, that are specifically attributable to an **ancillary service**, and that have been agreed to by the **Authority** and the **system operator**

allocable cost has the meaning set out in clauses 8.55 to 8.58

alternative agreement has the meaning given to it by clauses 8(1) and 8(2) of Schedule 12A.1

Clause 1.1(1) **alternative agreement**: inserted, on 20 July 2020, by clause 4(3) of the Electricity Industry Participation Code Amendment (Default Distributor Agreement) 2020.

alternative ancillary service arrangement means an arrangement between a **participant** and another **participant** or other person, or an arrangement involving only a **participant**, which is authorised by the **system operator** in accordance with clause 8.48

ancillary service means **black start, over frequency reserve, frequency keeping, instantaneous reserve** or **voltage support**

ancillary service agent means a person who provides an **ancillary service**

ancillary service arrangement means a contract between the **system operator** and an **ancillary service agent** for the procurement of **ancillary services** in accordance with clause 8.45

annual consumption list [*Revoked*]

Clause 1.1(1) **annual consumption list**: amended, on 5 October 2017, by clause 4(2) of the Electricity Industry Participation Code Amendment (Code Review Programme) 2017.

Clause 1.1(1) **annual consumption list**: revoked, on 1 November 2022, by clause 4(2) of the Electricity Industry Participation Code Amendment (Real Time Pricing) 2022.

applications layer means a part of a **metering installation** used for a function that is not performed by the **metrology layer**

Clause 1.1(1) **applications layer**: inserted, on 29 August 2013, by clause 4(1) of the Electricity Industry Participation (Metering Arrangements) Code Amendment 2011.

approved calibration laboratory means the Measurement Standards Laboratory of New Zealand, or a calibration laboratory that has been accredited under the Testing Laboratory Registration Act 1972 to ISO 17025, or an international laboratory that has been recognised by the Chief Metrologist for the specific **calibration** required

approved investment means—

- (a) an investment approved by the Electricity Commission under section III of part F of the **rules** before this Code came into force; or
- (b) an investment approved by the Commerce Commission under section 54R of the Commerce Act 1986; or
- (c) an investment that is permitted under an input methodology determined by the Commerce Commission under section 54S of the Commerce Act 1986

approved system means the system or systems required to convey information between persons in accordance with this Code, as may be approved from time to time by the **Authority**

Clause 1.1(1) **approved system**: inserted, on 5 October 2017, by clause 4(61) of the Electricity Industry Participation Code Amendment (Code Review Programme) 2017.

approved test house means a facility that has been approved by the **Authority** in accordance with Part 10 to do one or more of the following:

- (a) **calibrate metering installations or metering components**
- (b) **certify metering installations or metering components**

Clause 1.1(1) **approved test house**: amended, on 29 August 2013, by clause 4(2)(a) of the Electricity Industry Participation (Metering Arrangements) Code Amendment 2011.

Clause 1.1(1) **approved test house**: amended, on 19 December 2014, by clause 4(1) of the Electricity Industry Participation Code Amendment (Minor Code Amendments) (No 3) 2014.

Clause 1.1(1) **approved test house**: substituted, on 1 February 2016, by clause 4(1)(a) of the Electricity Industry Participation Code Amendment (Code Review Programme) 2015.

approved test laboratory means a test laboratory that has been accredited under the Standards and Accreditation Act 2015 to ISO 17025 for the specific test required

Clause 1.1(1) **approved test laboratory**: amended, on 5 October 2017, by clause 4(3) of the Electricity Industry Participation Code Amendment (Code Review Programme) 2017.

asset means equipment or plant that is connected to or forms part of the **grid** and, in the case of Part 8, includes equipment or plant that is intended to become connected to the **grid** and equipment or plant of an **embedded generator**

Clause 1.1(1) **asset**: amended, on 23 February 2015, by clause 75 of the Electricity Industry Participation Code Amendment (Distributed Generation) 2014.

Clause 1.1(1) **asset**: amended, on 5 October 2017, by clause 4(4) of the Electricity Industry Participation Code Amendment (Code Review Programme) 2017.

asset capability statement means a statement of capability and operational limitations that applies to specific **assets** during the normal and abnormal conditions that may arise on the **grid**, provided to the **system operator** in accordance with clause 2(5) of **Technical Code A** of Schedule 8.3

asset owner means a **participant** who owns an **asset** used for the generation or conveyance of **electricity** and a person who operates such **asset** and, in the case of Part 8, includes a **consumer** with a **point of connection** to the **grid**

asset owner performance obligations and **AOPO** means a performance obligation specified in subpart 2 of Part 8 that an **asset owner** must comply with so that the **system operator** can plan to comply and comply with its **principal performance obligations**

associated equipment, for the purposes of the definition of **distribution network** and Part 6, means any equipment that is used, or designed or intended for use, in relation to any works or **consumer installation**, if such use is for **construction**, maintenance, or safety purposes and not for purposes that relate directly to the generation, conversion, transformation, conveyance, or use of **electricity**

Clause 1.1(1) **associated equipment**: amended, on 23 February 2015, by clause 4(1) of the Electricity Industry Participation Code Amendment (Distributed Generation) 2014.

Clause 1.1(1) **associated equipment**: amended, on 5 October 2017, by clause 4(5) of the Electricity Industry Participation Code Amendment (Code Review Programme) 2017.

assumed co-efficient of variation [*Revoked*]

Clause 1.1(1) **assumed co-efficient of variation**: revoked, on 5 October 2017, by clause 4(60) of the Electricity Industry Participation Code Amendment (Code Review Programme) 2017.

ASX [Revoked]

Clause 1.1(1) **ASX**: inserted, on 3 February 2020, by clause 4 of the Electricity Industry Participation Code Amendment (Hedge Market Arrangements) 2020.

Clause 1.1(1) **ASX**: revoked, on 3 November 2020 in accordance with section 40(2)(b) of the Electricity Industry Act 2010.

ASX NZ electricity future [Revoked]

Clause 1.1(1) **ASX NZ electricity future**: inserted, on 3 February 2020, by clause 4 of the Electricity Industry Participation Code Amendment (Hedge Market Arrangements) 2020.

Clause 1.1(1) **ASX NZ electricity future**: revoked, on 3 November 2020 in accordance with section 40(2)(b) of the Electricity Industry Act 2010.

at risk HVDC transfer means the quantity of **MWh** for each **trading period** calculated in accordance with Tables 1 and 2, where—

$INJ_{HVDCHAYt}$ is the **electricity** injected from the **HVDC link** into the North Island **grid assets** at the North Island **HVDC injection point** in **trading period t**; and

$INJ_{HVDCBENT}$ is the **electricity** injected from the **HVDC link** into the South Island **grid assets** at the South Island **HVDC injection point** in **trading period t**

Table 1: HVDC northward transfer – if **electricity** is injected at the North Island **HVDC injection point** in the relevant **trading period**

HVDC configuration at the beginning of trading period t	At risk HVDC transfer north in trading period t (expressed in MWh)
Pole 2 only	$INJ_{HVDCHAYt}$
Pole 3 only	$INJ_{HVDCHAYt}$
Pole 3 and Pole 2 bipole round power	$INJ_{HVDCHAYt}$
Pole 3 and Pole 2 bipole not round power	$\max(0, INJ_{HVDCHAYt} - 325)$

Table 2: HVDC southward transfer – if **electricity** is injected at the South Island **HVDC injection point** in the relevant **trading period**

HVDC configuration at the beginning of trading period t	At risk HVDC transfer south in trading period t (expressed in MWh)
Pole 2 only	$INJ_{HVDCBENT}$
Pole 3 only	$INJ_{HVDCBENT}$
Pole 3 and Pole 2 bipole round power	$INJ_{HVDCBENT}$
Pole 3 and Pole 2 bipole not round power	$\max(0, INJ_{HVDCBENT} - 308)$

Clause 1.1(1) **at risk HVDC transfer**: substituted, on 1 July 2012, by clause 4(1) of the Electricity Industry Participation (HVDC Pole 3 Minor Amendments) Code Amendment 2012.

Clause 1.1(1) **at risk HVDC transfer**: amended, on 1 March 2024, by clause 4(1)(a) and (b) of the Electricity Industry Participation Code Amendment (Code Review Programme) 2024.

Clause 1.1(1) **Table 1 HVDC northward transfer**: amended, on 1 March 2024, by clause 4(1)(c) and (d) of the Electricity Industry Participation Code Amendment (Code Review Programme) 2024.

Clause 1.1(1) **Table 1 HVDC southward transfer**: amended, on 1 March 2024, by clause 4(1)(e) of the Electricity Industry Participation Code Amendment (Code Review Programme) 2024.

ATH means a person who is approved under Schedule 10.3 to operate an **approved test house**

Clause 1.1(1) **ATH**: inserted, on 29 August 2013, by clause 4(1) of the Electricity Industry Participation (Metering Arrangements) Code Amendment 2011.

auction means a must-run dispatch auction conducted by the **clearing manager** under subpart 3 of Part 13

auction bid means a bid made for an **auction** under clauses 13.117 to 13.130

auction revenue means, for a **generator**, the amount owing by the **generator** in accordance with clause 13.112(2) and, for a **purchaser**, the amount owing to the **purchaser** in accordance with clause 13.111

Clause 1.1(1) **auction revenue**: amended, on 24 March 2015, by clause 4(1)(a) of the Electricity Industry Participation (Settlement and Prudential Security) Code Amendment 2013.

auction right means the right (but not the obligation) to offer for sale a specified quantity of **electricity** to the **clearing manager** at 0 price in accordance with clause 13.116(1)

audit means a process of inspection of the facilities, processes, procedures, and other relevant items, to confirm compliance with this Code, and **audited** has a corresponding meaning

auditor means,—

- (a) for the purposes of Parts 10, 11, 15 and 16A—
 - (i) a person approved or appointed by the **Authority** to carry out an **audit**; or
 - (ii) the **Authority**, if the **Authority** carries out an **audit** itself; and
- (b) for all other Parts of this Code, a person carrying out an **audit**

Clause 1.1(1) **auditor**: replaced, on 1 June 2017, by clause 4(1) of the Electricity Industry Participation Code Amendment (Requirements and Processes for Audits) 2016.

Clause 1.1(1) **auditor**: amended, on 20 December 2021, by clause 4 of the Electricity Industry Participation Code Amendment (Code Review Programme) 2019.

AUFLS technical requirements report means the AUFLS technical requirements report that is incorporated by reference in this Code under clause 2 of Schedule 8.6

Clause 1.1(1) **AUFLS technical requirements report**: inserted, on 21 December 2021, by clause 4(1) of the Electricity Industry Participation Code Amendment (Automatic Under-Frequency Load Shedding Systems) 2021.

Authority has the meaning given to it by section 5 of the **Act**

automatic control plant means any hydro **generating plant** that has a pre-programmed generation profile and an automatic override if uncontrollable water inflows change

automatic under-frequency load shedding means automatic shedding of electrical load when frequency falls below the relevant pre-set frequency, or falls at a rate, specified by the **system operator** in the **AUFLS technical requirements report** or in clause 7(6) and 7(6A) of **Technical Code B** of Schedule 8.3

Clause 1.1(1) **automatic under-frequency load shedding**: amended, on 7 August 2014, by clause 4(1) of the Electricity Industry Participation Code Amendment (Extended Reserve) 2014.

Clause 1.1(1) **automatic under-frequency load shedding**: replaced, on 21 December 2021, by clause 4(2) of the Electricity Industry Participation Code Amendment (Automatic Under-Frequency Load Shedding Systems) 2021.

availability cost means a cost (other than an **administrative cost**), incurred by the **system operator** in purchasing **instantaneous reserve** and providing that **instantaneous reserve** for a **trading period**, and includes—

- (a) payments made by the **system operator** for that **trading period** under contracts that secure the availability of **instantaneous reserves**; and
- (b) the annual and variable costs (including any constrained-on costs) incurred by the **system operator** under any other contracts allocated by the **system operator** to that **trading period**; less
- (c) the costs of **instantaneous reserves** procured as a direct result of a **generator** being granted a **dispensation** under clause 8.31(1); and
- (d) **instantaneous reserve constrained on compensation** calculated in accordance with clause 13.212(6)

back office means a part of an **interrogation** system—

- (a) that sends or receives information to or from a **metering installation**; and
- (b) stores the information in a form that can be made available at the **services access interface** to another person

Clause 1.1(1) **back office**: inserted, on 29 August 2013, by clause 4(1) of the Electricity Industry Participation (Metering Arrangements) Code Amendment 2011.

back-up metering information *[Revoked]*

Clause 1.1(1) **back-up metering information**: revoked, on 1 November 2022, by clause 4(2) of the Electricity Industry Participation Code Amendment (Real Time Pricing) 2022.

back up protection system means a protection system—

- (a) that **electrically disconnects** faulted **assets** from the **grid** because a **main protection system** or a **circuit breaker** has failed to **electrically disconnect** a faulted **asset** from the **grid** in the allocated time; and
- (b) that may **electrically disconnect** non-faulted **assets** as well as a faulted **asset**

Clause 1.1(1) **back up protection system**: amended, on 5 October 2017, by clause 4(6)(a) and (b) of the Electricity Industry Participation Code Amendment (Code Review Programme) 2017.

balancing area means, in relation to any particular **ICP**,—

- (a) the **embedded network**; or
- (b) that part of the relevant **local network** owned by 1 **network owner**—
having 1 or more **NSPs**, to which that **ICP** is **electrically connected** from time to time under normal circumstances

Clause 1.1(1) **balancing area**: amended, on 23 February 2015, by clause 75 of the Electricity Industry Participation Code Amendment (Distributed Generation) 2014.

Clause 1.1(1) **balancing area**: amended, on 5 October 2017, by clause 4(7) of the Electricity Industry Participation Code Amendment (Code Review Programme) 2017.

bank means a registered bank within the meaning of the Reserve Bank of New Zealand Act 1989 that is carrying on in New Zealand the business of banking

bank bill bid rate means the rate per annum (rounded upwards to 2 decimal places) displayed at or about 10.45am on the Reuters Screen on page BKBM (or its successor or equivalent page) on the relevant date as the bank bill “settlement” bid rate for bank bills having a tenor of 1 month, provided that if such a rate is not available, **bank bill**

bid rate means the rate determined by the **clearing manager** to be the nearest practicable equivalent

base case means a base case **published** by the **Authority** under clause 13.236D

Clause 1.1(1) **base case**: inserted, on 1 December 2011, by clause 4 of the Electricity Industry Participation Code (Spot Price Risk Disclosure) Amendment 2011.

Clause 1.1(1) **base case**: amended, on 5 October 2017, by clause 4(8) of the Electricity Industry Participation Code Amendment (Code Review Programme) 2017.

benchmark agreement [*Revoked*]

Clause 1.1(1) **benchmark agreement**: amended, on 23 February 2015, by clause 75 of the Electricity Industry Participation Code Amendment (Distributed Generation) 2014.

Clause 1.1(1) **benchmark agreement**: amended, on 5 October 2017, by clause 4(9) of the Electricity Industry Participation Code Amendment (Code Review Programme) 2017.

Clause 1.1(1) **benchmark agreement**: revoked, on 1 October 2023, by clause 4(2) of the Electricity Industry Participation Code Amendment (Default Transmission Agreement) 2023.

benefit to the public means public benefit net of any costs and detriments, including those detriments associated with a lessening of competition as those concepts are applied under the Commerce Act 1986

bid,—

(a) means—

(i) a **nominated bid**;

(ii) a **difference bid**; and

(b) includes a **bid** revised in accordance with clause 13.19A or 13.19B

(c) [*Revoked*]

Clause 1.1(1) **bid**: substituted, on 28 June 2012, by clause 4(b) of the Electricity Industry Participation (Demand-side Bidding and Forecasting) Code Amendment 2011.

Clause 1.1(1) **bid** paragraph (b): amended, on 29 June 2017, by clause 4(1)(a) of the Electricity Industry Participation Code Amendment (Shortened Gate Closure and Revised Bid and Offer Provisions) 2017.

Clause 1.1(1) **bid** paragraph (c): revoked, on 29 June 2017, by clause 4(1)(b) of the Electricity Industry Participation Code Amendment (Shortened Gate Closure and Revised Bid and Offer Provisions) 2017.

bid-ask spread means—

(a) if expressed as a dollar value, the dollar value that represents the difference in price between a **quote** to buy a **NZ electricity future** and a **quote** to sell a **NZ electricity future** of the same type on the same **exchange**; or

(b) if expressed as a percentage, the percentage calculated by dividing the difference between the price of a **quote** to buy a **NZ electricity future** and the price of a **quote** to sell a **NZ electricity future** of the same type on the same **exchange** by the price of the **quote** to sell a **NZ electricity future**.

Clause 1.1(1) **bid-ask spread**: inserted, on 3 February 2020, by clause 4 of the Electricity Industry Participation Code Amendment (Hedge Market Arrangements) 2020.

Clause 1.1(1) **bid-ask spread**: revoked, on 3 November 2020 in accordance with section 40(2)(b) of the Electricity Industry Act 2010.

Clause 1.1(1) **bid-ask spread**: inserted, on 27 April 2021, by clause 4(2) of the Electricity Industry Participation Code Amendment (Hedge Market Arrangements) 2021.

binary load, in relation to a **nominated dispatch bid**, means a quantity of **electricity** that corresponds to the **MW** specified in one or more entire price bands of the relevant **nominated dispatch bid**

Clause 1.1(1) **binary load**: inserted, on 1 November 2022, by clause 4(1) of the Electricity Industry Participation Code Amendment (Real Time Pricing) 2022.

binding constraint means a **constraint** that is likely to cause a significant difference between the price at 1 **node** and the price at another **node**

billing period means a period of 1 calendar month

black start means an **ancillary service** required to enable a **generating unit** isolated from the **grid** to be—

(a) made live, as defined in the Electricity (Safety) Regulations 2010; and

(b) **electrically connected to the grid**

Clause 1.1(1) **black start**: amended, on 23 February 2015, by clause 75 of the Electricity Industry Participation Code Amendment (Distributed Generation) 2014.

Clause 1.1(1) **black start**: replaced, on 5 October 2017, by clause 4(1)(a) of the Electricity Industry Participation Code Amendment (Code Review Programme) 2017.

block dispatch group means a group of **generating stations** on 1 continuous water course, which is the subject of an agreement between the **system operator** and a **generator** under clause 13.60

block security constraint means any of the following:

(a) a security constraint as determined in accordance with the **policy statement** and applied by the **system operator** to a **generating unit** or **generating station** to provide **voltage support** or **frequency keeping**:

(b) a limitation in **grid** capacity that:

(i) is a limitation in the capacity of the **grid** to convey **electricity** between either:

(A) **generating stations** constituting a **block dispatch group**; or

(B) **generating stations** constituting a **block dispatch group** and the **grid**; and

(ii) arises because of either—

(A) a limitation in the offered capacity of the **grid**; or

(B) a security constraint as determined by the **system operator** in accordance with the **policy statement**.

Clause 1.1(1) **block security constraint**: replaced, on 31 December 2021, by clause 4(2) of the Electricity Industry Participation Code Amendment (Code Review Programme) 2019.

bona fide physical reason includes,—

(a) in relation to a **generator**, or a **purchaser**, or an **ancillary service agent** or a **grid owner**, a situation where personnel or plant safety is at risk; and

(b) in relation to a **generator** or an **ancillary service agent** providing **generation reserve** or **frequency keeping**,—

(i) a reasonably unforeseeable change in generating capability, reserve capability, or **frequency keeping** capability (as the case may be) from an item of **generating plant** that is the subject of an existing **offer**, **reserve offer**, or offer to provide **frequency keeping** by that **generator** or **ancillary service agent**; or

(ii) a reasonably unforeseeable change in the level of expected uncontrollable water inflows into the head pond of a hydro station that is the subject of an existing **offer**, **reserve offer**, or offer to provide **frequency keeping** by that **generator** or **ancillary service agent**; or

- (iii) a reasonably unforeseeable change in circumstances such that the **generator** or **ancillary service agent** will breach any consent held by it under the Resource Management Act 1991; or
- (iv) a reasonably unforeseeable physical infeasibility that arises from a **price-responsive schedule**, a **non-response schedule**, or a **dispatch schedule**; and
- (ba) in relation to an **intermittent generator**, a situation in which—
 - (i) variable resource conditions prevent the **intermittent generator** from generating at the level expected; or
 - (ii) the **intermittent generator** reduces the output of an **intermittent generating station**—
 - (A) to prevent an **un-modelled transmission asset** from exceeding its ratings; or
 - (B) in order to comply with an automated signal to maintain frequency; or
 - (C) in light of reasonably unforeseeable circumstances that require the output of the **intermittent generating station** to be reduced to enable the **intermittent generator** to comply with the conditions of a resource consent or other law; or
 - (D) in anticipation of the expected onset of a weather event that would be likely to cause the **intermittent generating station's** asset protection systems to shut down assets forming part of the **intermittent generating station**; and
- (c) in relation to a **purchaser**, or an **ancillary service agent** providing **interruptible load**,—
 - (i) a reasonably unforeseeable full or partial loss of demand or reserve capability (as the case may be) at a **grid exit point** that is the subject of an existing **bid** or **reserve offer** by the **purchaser** or the **ancillary service agent**; or
 - (ii) a reasonably unforeseeable change in circumstances such that the **purchaser** or **ancillary service agent** will breach any consent held by it under the Resource Management Act 1991; or
 - (iii) a reasonably unforeseeable full or partial loss of generating capability from an item of **generating plant** owned by, or the subject of a supply contract with, that **purchaser** during the relevant **trading periods**; and
- (d) in relation to a **grid owner**, a reasonably unforeseeable loss of full or partial capacity on transmission plant forming part of the **grid**

Clause 1.1(1) **bona fide physical reason** paragraph (b): amended, on 3 May 2022, by clause 4(2) of the Electricity Industry Participation Code Amendment (Enabling Energy Storage Systems to Offer Instantaneous Reserve) 2022.

Clause 1.1(1) **bona fide physical reason** paragraph(b)(iv): substituted, on 28 June 2012, by clause 4(c)(i) of the Electricity Industry Participation (Demand-side Bidding and Forecasting) Code Amendment 2011.

Clause 1.1(1) **bona fide physical reason** paragraph(c)and(c)(i): amended, on 28 June 2012, by clause 4(c)(ii)and(iii) of the Electricity Industry Participation (Demand-side Bidding and Forecasting) Code Amendment 2011.

Clause 1.1(1) **bona fide physical reason** paragraph (ba): inserted, at 12.00 pm on 19 September 2019, by clause 4(1) of the Electricity Industry Participation Code Amendment (Wind Offer Arrangements) 2019.

Clause 1.1(1) **bona fide physical reason** paragraph (ba)(i): amended, on 20 March 2020, by clause 4(1) of the Electricity Industry Participation Code Amendment (Broadening Definitions of Generating Unit and Intermittent Generating Station) 2020.

bound [*Revoked*]

Clause 1.1(1) **bound**: amended, on 1 February 2016, by clause 4(3) of the Electricity Industry Participation Code Amendment (Code Review Programme) 2015.

Clause 1.1(1) **bound**: revoked, on 1 November 2022, by clause 4(2) of the Electricity Industry Participation Code Amendment (Real Time Pricing) 2022.

branch means an electrical link between—

- (a) 2 or more **nodes**; or
- (b) a **node** and a **point of connection** to the **grid**

business means, except in Part 6A, the business carried out as a **participant**

Clause 1.1(1) **business**: amended, on 1 March 2024, by clause 4(2) of the Electricity Industry Participation Code Amendment (Code Review Programme) 2024.

business day means,—

- (a) for the purposes of Part 6, any day of the week other than Saturday, Sunday, or a public holiday within the meaning of the Holidays Act 2003; and
- (b) for the rest of the Code, any day of the week except Saturdays, Sundays, **national holidays**, the day observed as Wellington Anniversary Day, and any other day from time to time declared by the **Authority** not to be a **business day** by notice to each **registered participant**

Clause 1.1(1) **business day**: amended, on 21 September 2012, by clause 4(1) of the Electricity Industry Participation (Minor Amendments) Code Amendment 2012.

Clause 1.1(1) **business day**: amended, on 5 October 2017, by clause 4(10) of the Electricity Industry Participation Code Amendment (Code Review Programme) 2017.

Clause 1.1(1) **business day**: amended, on 1 March 2024, by clause 4(3) of the Electricity Industry Participation Code Amendment (Code Review Programme) 2024.

buyer, for the purposes of subpart 5 and subpart 7 of Part 13, means—

- (a) in respect of a **contract for differences**, the fixed-price payer, being the **party** obliged to make payments at a fixed price from time to time during the **term** of the contract; or
- (b) in respect of a **fixed-price physical supply contract**, the purchaser of **electricity**; or
- (c) in respect of an **options contract**, either—
 - (i) the **party** paying the **premium**; or
 - (ii) if there is no **premium**, the **party** who agrees to be the **buyer** for the purposes of subpart 5 or subpart 7 (as applicable) of Part 13; or
 - (iii) if neither **party** agrees to be the **buyer**, the **party** whose name is the first alphabetically
- (d) for the purposes of subpart 7 of Part 13, in respect of any other contract, the **party** consuming the **electricity** that the contract relates to

Clause 1.1(1) **buyer**: amended, on 19 August 2022, by clause 4(2) of the Electricity Industry Participation Code Amendment (Restrictions on Materially Large Contracts) 2022.

Clause 1.1(1) **buyer**: revoked, on 18 May 2023, by clause 2(2) of the Electricity Industry Participation Code Amendment (Restrictions on Materially Large Contracts) 2023.

Clause 1.1(1) **buyer**: inserted, on 19 May 2023, by clause 4(2) of the Electricity Industry Participation Code Amendment (Restrictions on Materially Large Contracts) 2023.

calibration means the set of operations that establishes, under specified conditions, the relationship between the values indicated by the measuring system and the corresponding

values of a quantity realised by a **reference standard** or **working standard**, and **calibrate** and **calibrated** have corresponding meanings

calibration report means a report that contains the results of all **calibration** tests carried out on—

- (a) a **metering installation**; or
- (b) a **metering component in a metering installation**; or
- (c) a **working standard**

Clause 1.1(1) **calibration report**: substituted, on 29 August 2013, by clause 4(2)(b) of the Electricity Industry Participation (Metering Arrangements) Code Amendment 2011.

call [*Revoked*]

Clause 1.1(1) **call**: revoked, on 24 March 2015, by clause 4(1)(b) of the Electricity Industry Participation (Settlement and Prudential Security) Code Amendment 2013.

capacity [*Revoked*]

Clause 1.1(1) **capacity**: revoked, on 23 February 2015, by clause 4(11) of the Electricity Industry Participation Code Amendment (Distributed Generation) 2014.

capacity reserve means—

- (a) demand that can be decreased for the purpose of adjusting a **constraint**; or
- (b) generation that can be increased or decreased for the purpose of adjusting a **constraint**

cash deposit means the cash deposited in **cleared funds** by a **participant** in accordance with clause 2 of Schedule 14A.1, and includes any interest under clause 14A.14 that has not been paid out

Clause 1.1(1) **cash deposit**: amended, on 24 March 2015, by clause 4(1)(c) of the Electricity Industry Participation (Settlement and Prudential Security) Code Amendment 2013.

cash deposit accounts means the trust accounts established by the **clearing manager** in accordance with clause 14A.11

Clause 1.1(1) **cash deposit accounts**: amended, on 24 March 2015, by clause 4(1)(d) of the Electricity Industry Participation (Settlement and Prudential Security) Code Amendment 2013.

cash interest rate [*Revoked*]

Clause 1.1(1) **cash interest rate**: revoked, on 24 March 2015, by clause 4(1)(e) of the Electricity Industry Participation (Settlement and Prudential Security) Code Amendment 2013.

category 1 metering installation means a **metering installation** that has the required defining characteristics for a **metering installation** of that category in Table 1 of Schedule 10.1

Clause 1.1(1) **category 1 metering installation**: inserted, on 1 December 2011, by clause 4(a) of the Electricity Industry Participation Code (Distributor Use-of-System Agreements and Distributor Tariffs) Amendment 2011.

Clause 1.1(1) **category 1 metering installation**: substituted, on 29 August 2013, by clause 4(2)(c) of the Electricity Industry Participation (Metering Arrangements) Code Amendment 2011.

category 2 metering installation means a **metering installation** that has the required defining characteristics for a **metering installation** of that category in Table 1 of Schedule 10.1

Clause 1.1(1) **category 2 metering installation**: inserted, on 1 December 2011, by clause 4(a) of the Electricity Industry Participation Code (Distributor Use-of-System Agreements and Distributor Tariffs) Amendment 2011.

Clause 1.1(1) **category 2 metering installation**: substituted, on 29 August 2013, by clause 4(2)(d) of the Electricity Industry Participation (Metering Arrangements) Code Amendment 2011.

causer, in relation to an **under-frequency event**, means—

- (a) if the **under-frequency event** is caused by an interruption or reduction of **electricity** from a single **generator's** or **grid owner's asset** or **assets**, the **generator** or **grid owner**; unless—
- (i) the **under-frequency event** is caused by an interruption or reduction of **electricity** from a single **generator's asset** or **assets** but another **generator's** or a **grid owner's** act or omission or property causes the interruption or reduction of **electricity**, in which case the other **generator** or the **grid owner** is the **causer**; or
- (ii) the **under-frequency event** is caused by an interruption or reduction of **electricity** from a single **grid owner's asset** or **assets** but a **generator's** or another **grid owner's** act or omission or property causes the interruption or reduction of **electricity**, in which case the **generator** or other **grid owner** is the **causer**; or
- (b) if the **under-frequency event** is caused by more than 1 interruption or reduction of **electricity**, the **generator** or **grid owner** who, in accordance with paragraph (a), would be the **causer** of the **under-frequency event** if it had been caused by the first in time of the interruption or reduction of **electricity**; but
- (c) if an interruption or reduction of **electricity** occurs in order to comply with this Code, the interruption or reduction of **electricity** must be disregarded for the purposes of determining the **causer** of the **under-frequency event**

centralised data set [*Revoked*]

Clause 1.1(1) **centralised data set**: revoked, on 1 February 2016, by clause 4(2) of the Electricity Industry Participation Code Amendment (Code Review Programme) 2015.

certification means—

- (a) if applied to a **metering installation**, confirmation that the **metering installation** meets the requirements of this Code; and
- (b) if applied to a **metering component**, confirmation that the **metering component** meets the requirements of this Code; and
- (c) if applied to a **reconciliation participant**, confirmation that that **reconciliation participant** has met the requirements of Schedule 15.1

Clause 1.1(1) **certification**: amended, on 29 August 2013, by clause 4(2)(e) of the Electricity Industry Participation (Metering Arrangements) Code Amendment 2011.

certification report means a report that contains—

- (a) the **calibration report** or **calibration reports**;
- (b) all other information relevant to the **certification** of a **metering installation** or a **metering component** required under Part 10

Clause 1.1(1) **certification report**: substituted, on 29 August 2013, by clause 4(2)(f) of the Electricity Industry Participation (Metering Arrangements) Code Amendment 2011.

certification sticker means a sticker that is valid for a specific period and that is attached—

- (a) to a **metering installation**, confirming that the **metering installation** has been **certified** by an **ATH** under Schedule 10.7; or
- (b) to a **metering component**, confirming that the **metering component** has been **certified** by an **ATH** under Schedule 10.8

Clause 1.1(1) **certification sticker**: substituted, on 29 August 2013, by clause 4(2)(g) of the Electricity Industry Participation (Metering Arrangements) Code Amendment 2011.

certified means having achieved **certification**

certify means to carry out a **certification**

chargeable capacity means the capacity that the **distributor** may charge for, but that may not be the actual installed capacity at the relevant **ICP**

check metering information *[Revoked]*

Clause 1.1(1) **check metering information**: revoked, on 1 November 2022, by clause 4(2) of the Electricity Industry Participation Code Amendment (Real Time Pricing) 2022.

circuit branch means a **branch** that is not a **transformer branch** or the **HVDC link**

circuit breaker means a switching device capable of making, carrying and breaking currents under normal circuit conditions, and capable of making, carrying for a specified time and breaking currents under specified abnormal conditions (such as a short circuit)

circuit breaker failure protection system means a protection system that—

- (a) operates because a **circuit breaker** has failed to **electrically disconnect** a faulted **asset** from the **grid** in the allocated time; and
- (b) may **electrically disconnect** non-faulted **assets** from the **grid** as well as a faulted **asset**

Clause 1.1(1) **circuit breaker failure protection system**: amended, on 5 October 2017, by clause 4(11) of the Electricity Industry Participation Code Amendment (Code Review Programme) 2017.

class A approved test house *[Revoked]*

Clause 1.1(1) **class A approved test house**: revoked, on 29 August 2013, by clause 4(3) of the Electricity Industry Participation (Metering Arrangements) Code Amendment 2011.

class A ATH means an **ATH** who is approved under clause 3 of Schedule 10.3

Clause 1.1(1) **class A ATH**: inserted, on 29 August 2013, by clause 4(1) of the Electricity Industry Participation (Metering Arrangements) Code Amendment 2011.

class B approved test house *[Revoked]*

Clause 1.1(1) **class B approved test house**: revoked, on 29 August 2013, by clause 4(3) of the Electricity Industry Participation (Metering Arrangements) Code Amendment 2011.

class B ATH means an **ATH** who is approved under clause 4 of Schedule 10.3

Clause 1.1(1) **class B ATH**: inserted, on 29 August 2013, by clause 4(1) of the Electricity Industry Participation (Metering Arrangements) Code Amendment 2011.

cleared funds, in relation to a **business day**, means funds that are immediately available for disbursement on that day

clearing auction price means the lowest successful price bid at an **auction** in dollars per **MW** per **half hour**

clearing manager has the meaning given to it in section 5 of the **Act**

Code information means all information that is supplied by 1 **participant** to another **participant**, or group of **participants**, under this Code (other than **excluded Code information** and information that is supplied under Parts 2 to 6 and 9 of this Code)

Clause 1.1(1) **Code information**: amended, on 16 December 2013, by clause 4(1) of the Electricity Industry Participation (Revocation of Part 16) Code Amendment 2013.

code of practice means a code of practice issued under this Code

Clause 1.1(1) **code of practice**: amended, on 29 August 2013, by clause 4(2)(h) of the Electricity Industry Participation (Metering Arrangements) Code Amendment 2011.

co-efficient of variation means the ratio of the standard deviation to the mean of the distribution for the random variable under consideration

co-generator [*Revoked*]

Clause 1.1(1) **co-generator**: revoked, on 27 May 2015, by clause 4(1) of the Electricity Industry Participation Code Amendment (Industrial Co-generation Dispatch Arrangements) 2015.

collateral term means a term in a **default distributor agreement** that is not—

- (a) a **core term**; or
- (b) an **operational term**; or
- (c) a **recorded term**; or
- (d) a term required in accordance with clause 3(1)(d) of Schedule 12A.4

Clause 1.1(1) **collateral term**: inserted, on 20 July 2020, by clause 4(3) of the Electricity Industry Participation Code Amendment (Default Distributor Agreement) 2020.

commissioning means to verify the correct operation of—

- (a) an **asset**; or
- (b) a **point of connection**; or
- (c) metering equipment installed in a **metering installation**,—

and **commissioned** has a corresponding meaning

Clause 1.1(1) **commissioning**: amended, on 29 August 2013, by clause 4(2) of the Electricity Industry Participation (Metering Arrangements) Code Amendment 2013.

Clause 1.1(1) **commissioning**: replaced, on 5 October 2017, by clause 4(1)(b) of the Electricity Industry Participation Code Amendment (Code Review Programme) 2017.

commissioning report [*Revoked*]

Clause 1.1(1) **commissioning report**: revoked, on 29 August 2013, by clause 4(3) of the Electricity Industry Participation (Metering Arrangements) Code Amendment 2011.

committed projects means transmission augmentation projects and **non-transmission projects** that are reasonably likely to proceed in a similar timeframe for which the assessment of costs and benefits under a net benefits test set out in Part 12 is undertaken, and in relation to which either—

- (a) all of the following are satisfied:
 - (i) the proponent has obtained all required planning consents, construction approvals, and licences, and fulfilled any other regulatory requirement that must be met before commencing construction;
 - (ii) construction has commenced or a firm commencement date for construction has been set;
 - (iii) the proponent has acquired or executed an agreement to acquire land (or commenced legal proceedings to acquire land), or has executed an agreement for the leasing of land, for the purposes of construction;
 - (iv) contracts for supply and construction of the major components of the plant and equipment (including any **generating units**, turbines, boilers, transmission towers, conductors, termination station equipment) have been executed (i.e. all the necessary formal legal requirements have been observed to make the contract valid and complete):

- (v) contracts for the financing of the project, including any debt plans, have been executed (i.e. all the necessary formal legal requirements have been observed to make the contract valid and complete); or
- (b) in the case of transmission augmentation projects, the project is an **approved investment**

common quality means those elements of quality of **electricity** conveyed across the **grid** that cannot be technically or commercially isolated to an identifiable person or group of persons

communication means, for the purposes of Part 10, the electronic transfer of information, or instructions, to or from a **metering installation**

Clause 1.1(1) **communication**: inserted, on 29 August 2013, by clause 4(1) of the Electricity Industry Participation (Metering Arrangements) Code Amendment 2011.

communication equipment means a device, used for **communication**, in—

- (a) a **metering installation**; or
- (b) a **back office**

Clause 1.1(1) **communication equipment**: inserted, on 29 August 2013, by clause 4(1) of the Electricity Industry Participation (Metering Arrangements) Code Amendment 2011.

comparative recertification means **recertification** of a **category 2 metering installation** under clause 12(3) of Schedule 10.7

Clause 1.1(1) **comparative recertification**: inserted, on 29 August 2013, by clause 4(1) of the Electricity Industry Participation (Metering Arrangements) Code Amendment 2011.

compensation factor means any of the following factors used to compensate for errors, **losses**, or ratios within a **metering installation** that are required to be applied to raw meter data:

- (a) **error compensation**;
- (b) **loss compensation**;
- (c) **ratio compensation**

To avoid doubt, the **raw meter data** from a **metering installation** may require more than one **compensation factor**, if the relevant types of compensation are required.

Clause 1.1(1) **compensation factor**: inserted, on 29 August 2013, by clause 4(1) of the Electricity Industry Participation (Metering Arrangements) Code Amendment 2011.

Clause 1.1(1) **compensation factor**: amended, on 1 February 2021, by clause 4(1) of the Electricity Industry Participation Code Amendment (Metering and Related Registry Processes) 2020.

Clause 1.1(1) **compensation factor**: amended, on 20 December 2021, by clause 4(3) of the Electricity Industry Participation Code Amendment (Code Review Programme) 2019.

complete *[Revoked]*

Clause 1.1(1) **complete**: revoked, on 16 December 2013, by clause 4(2)(a) of the Electricity Industry Participation (Revocation of Part 16) Code Amendment 2013.

confidential information, for the purposes of Schedule 6.2, means all data and other information of a confidential nature provided by 1 party (A) to another party (B) under the **regulated terms**, but excludes—

- (a) information known to B before the date it was provided by B to A and that was not obtained directly or indirectly from A; and
- (b) information obtained bona fide from another person who is in lawful possession of the information and who did not acquire the information directly or indirectly from A under an obligation of confidence

conforming GXP means a **GXP** that—

- (a) has been determined by the **Authority** to be a **conforming GXP** under clause 13.27A or 13.27B(4); or
- (b) is deemed to be a **conforming GXP** under clause 13.27F

Clause 1.1(1) **conforming GXP**: inserted, on 28 March 2012, by clause 4(a) of the Electricity Industry Participation (Demand-side Bidding and Forecasting) Code Amendment 2011.

congestion management policy means the policies, clauses, or conditions referred to in clause 6.3(2)(d)

connect*[Revoked]*

Clause 1.1(1) **connect**: amended, on 23 February 2015, by clause 4(2) of the Electricity Industry Participation Code Amendment (Distributed Generation) 2014.

Clause 1.1(1) **connect**: revoked, on 5 October 2017, by clause 4(60) of the Electricity Industry Participation Code Amendment (Code Review Programme) 2017.

connected asset owner means a **direct consumer**, or a **distributor** in its capacity as the owner or operator of a **local network**

Clause 1.1(1) **connected asset owner**: inserted, on 1 February 2016, by clause 4(19) of the Electricity Industry Participation Code Amendment (Code Review Programme) 2015.

connection and operation standards, in relation to a **distributor** or **distributed generation**,—

- (a) means requirements, as amended from time to time by the **distributor**, that—
 - (i) are set out in written policies and standards of the **distributor**; and
 - (ii) relate to connecting **distributed generation** to a **distribution network** or to a **consumer installation** that is connected to a **distribution network**, and the operation of the **distribution network**, including requirements relating to the planning, design, construction, testing, inspection, and operation of **distributed generation** that is, or is proposed to be, connected; and
 - (iii) are made publicly available in accordance with clause 6.3; and
 - (iv) reflect, or are consistent with, **reasonable and prudent operating practice**; and
- (b) includes the following, as amended from time to time by the **distributor**:
 - (i) the **distributor's congestion management policy**, as referred to in clause 6.3(2)(d); and
 - (ii) the **distributor's** emergency response policies; and
 - (iii) the **distributor's** safety standards; and
- (c) until 1 September 2026, may include the **distributor's** policies for specifying available **maximum export power** amongst categories of **network** users, a **maximum export power** threshold for applications under Part 1A of Schedule 6.1, and the methodology used to determine that threshold

Clause 1.1(1) **connection and operation standards**: amended, on 23 February 2015, by clause 4(3) of the Electricity Industry Participation Code Amendment (Distributed Generation) 2014.

Clause 1.1(1) **connection and operation standards**: amended, on 23 February 2015, by clause 75 of the Electricity Industry Participation Code Amendment (Distributed Generation) 2014.

Clause 1.1(1) **connection and operation standards**, paragraph (a)(ii): replaced, on 5 October 2017, by clause 4(12) of the Electricity Industry Participation Code Amendment (Code Review Programme) 2017.

Clause 1.1(1) **connection and operation standards**, paragraph (b)(iii): amended, on 1 September 2021, by clause 4(1)(a) of the Electricity Industry Participation Code Amendment (Application for Distributed Generation) 2021.

Clause 1.1(1) **connection and operation standards**, paragraph (c): inserted, on 1 September 2021, by clause 4(1)(b) of the Electricity Industry Participation Code Amendment (Application for Distributed Generation) 2021. **Note:**

paragraph (c) automatically revokes on the close of 1 September 2026 under clause 8 of the Electricity Industry Participation Code Amendment (Application for Distributed Generation) 2021.

connection asset, for the purposes of subparts 2, 6 and 7 of Part 12, has the meaning set out in the **transmission pricing methodology**

Connection Code means the Connection Code that is included in the **default transmission agreement template** as Schedule 8

Clause 1.1(1) **Connection Code**: amended, on 1 October 2023, by clause 4(3) of the Electricity Industry Participation Code Amendment (Default Transmission Agreement) 2023.

connection location means a substation or other location at which **lines**, equipment and plant owned or managed by a **designated transmission customer** that are directly related to a **point of connection**, and that are used for the consumption, conveyance, or generation of **electricity**, are directly connected to the **grid**

Clause 1.1(1) **connection location**: amended, on 23 February 2015, by clause 75 of the Electricity Industry Participation Code Amendment (Distributed Generation) 2014.

Clause 1.1(1) **connection location**: amended, on 1 February 2016, by clause 4(4) of the Electricity Industry Participation Code Amendment (Code Review Programme) 2015.

Clause 1.1(1) **connection location**: amended, on 5 October 2017, by clause 4(13) of the Electricity Industry Participation Code Amendment (Code Review Programme) 2017.

constrained off amounts means the amounts calculated by the **clearing manager** under clauses 13.194 to 13.196

constrained off compensation means either—

- (a) **constrained off amounts** owing to a **dispatched purchaser** under clause 13.201A; or
- (b) **constrained off amounts** owing to the **clearing manager** under clause 13.201A by **purchasers**

Clause 1.1(1) **constrained off compensation**: inserted, on 15 May 2014, by clause 5(1) of the Electricity Industry Participation (Modified Dispatchable Demand) Code Amendment 2013.

Clause 1.1(1) **constrained off compensation**: amended, on 24 March 2015, by clause 4(1)(g) of the Electricity Industry Participation (Settlement and Prudential Security) Code Amendment 2013.

constrained off situation means a situation as defined in clause 13.192

constrained on amounts means the amounts calculated by the **clearing manager** under clauses 13.204 and 13.205

constrained on compensation means, as the case may be,—

- (a) the **constrained on amounts** owing to—
 - (i) a **generator** under clause 13.212(1)(a); or
 - (ii) an **ancillary service agent** under clause 13.212(1)(a); or
 - (iii) a **dispatched purchaser** under clause 13.212(1)(b); or
- (b) the **constrained on amounts** owing by—
 - (i) the **system operator** under clause 13.212(2); or
 - (ii) a **purchaser** under clause 13.212(5)

Clause 1.1(1) **constrained on compensation**: substituted, on 15 May 2014, by clause 5(2) of the Electricity Industry Participation (Modified Dispatchable Demand) Code Amendment 2013.

Clause 1.1(1) **constrained on compensation**: amended, on 24 March 2015, by clause 4(1)(f) of the Electricity Industry Participation (Settlement and Prudential Security) Code Amendment 2013.

constrained on situation means a situation as defined in clause 13.202

constraint means a limitation in the capacity of the **grid** to convey electricity caused by limitations in capability of available **assets** forming the **grid** or limitations in the performance of the integrated power system

constraint price *[Revoked]*

Clause 1.1(1) **constraint price**: amended, on 15 May 2014, by clause 4(1) of the Electricity Industry Participation (Minor Code Amendments) Code Amendment 2014.

Clause 1.1(1) **constraint price**: revoked, on 1 November 2022, by clause 4(2) of the Electricity Industry Participation Code Amendment (Real Time Pricing) 2022.

construct, for the purposes of the definition of **associated equipment** and Part 6, includes to erect, to lay, and to place, and **construction** has a corresponding meaning

Clause 1.1(1) **construct**: amended, on 21 September 2012, by clause 4(2) of the Electricity Industry Participation (Minor Amendments) Code Amendment 2012.

consumer means a person who is supplied **electricity** for consumption, and includes a **distributor**, a **retailer** or a **generator** if the **distributor**, or the **retailer** or the **generator** is supplied with **electricity** for its own consumption

consumer installation, for the purposes of the definition of **associated equipment** and Part 6, means—

- (a) all fittings that are part of a system for conveying **electricity** from a **consumer's point of supply** to any point from which **electricity** conveyed through that system may be consumed; and
- (b) includes any fittings that are used, or designed or intended for use, by any person in, or in relation to, the generation of **electricity**—
 - (i) for that person's use and not for supply to any other person; or
 - (ii) so that **electricity** can be injected into a **distribution network**; but
- (c) does not include any appliance that uses, or is designed or intended to use, **electricity**, whether or not it also uses, or is designed or intended to use, any other form of energy

Clause 1.1(1) **consumer installation**: substituted, on 23 February 2015, by clause 4(4)(a) of the Electricity Industry Participation Code Amendment (Distributed Generation) 2014.

Clause 1.1(1) **consumer installation**: amended, on 5 October 2017, by clause 4(14) of the Electricity Industry Participation Code Amendment (Code Review Programme) 2017.

consumption information means the information describing the quantity of **electricity** conveyed during the period for which the information is required, which may be directly measured or calculated from information obtained from a **metering installation**, or calculated in accordance with this Code

consumption pattern means, for the purposes of this Part and Schedule 15.5, the shape of the half **hourly** consumption

consumption period means a calendar month during which **electricity** is supplied to **consumers** (and conversely produced by **generators**)

contract for differences, for the purposes of subpart 5 and subpart 7 of Part 13, means a financial derivative contract—

- (a) under which 1 or both **parties** makes or may make a payment to the other **party**; and
- (b) in which the payment to be made depends on, or is derived from, the price of a

- specified **quantity of electricity** at a particular time; and
- (c) that may provide a means for the risk to 1 or both **parties** of an increase or decrease in the price of **electricity** to be reduced or eliminated; and
- (d) that either—
- (i) relates to a quantity of **electricity** that equals or exceeds 0.25 **MW** of **electricity**; or
 - (ii) is entered into through a derivatives exchange, being a market in which **parties** trade standardised financial derivative contracts, and contracts containing the right to buy or sell standardised financial derivative contracts, with a central counterparty

Clause 1.1(1) **contract for differences**: amended, on 15 January 2016, by clause 4(5) of the Electricity Industry Participation Code Amendment (Code Review Programme) 2015.

Clause 1.1(1) **contract for differences**: amended, on 19 August 2022, by clause 4(3) of the Electricity Industry Participation Code Amendment (Restrictions on Materially Large Contracts) 2022.

Clause 1.1(1) **contract for differences**: revoked, on 18 May 2023, by clause 2(2) of the Electricity Industry Participation Code Amendment (Restrictions on Materially Large Contracts) 2023.

Clause 1.1(1) **contract for differences**: inserted, on 19 May 2023, by clause 4(3) of the Electricity Industry Participation Code Amendment (Restrictions on Materially Large Contracts) 2023.

contract price means, in respect of a **risk management contract**, a single price that has, in accordance with clause 13.220, been calculated, time weighted, adjusted to a location factor for the relevant **grid zone area**, and corrected for **losses**, for the purposes of subpart 5 of Part 13

Clause 1.1(1) **contract price**: amended, on 20 December 2021, by clause 4(4) of the Electricity Industry Participation Code Amendment (Code Review Programme) 2019.

contract price schedule means, in respect of a **risk management contract**, a price or series of prices to be paid under that contract in respect of specified times or amounts and at a single location

contract specifications means specifications prescribing the specific terms of, and terms of trading in, each class of contract that may from time to time be traded on a market under this Code

control device means a device in a **metering installation** that controls either or both of the following:

- (a) **electricity**—
- (i) conveyed through the **metering installation**; and
 - (ii) used to satisfy controllable load:
- (b) a **meter** register in the **metering installation**

Clause 1.1(1) **control device**: inserted, on 29 August 2013, by clause 4(1) of the Electricity Industry Participation (Metering Arrangements) Code Amendment 2011.

controller means,—

- (a) in relation to a company,—
- (i) any person in accordance with whose directions and instructions the persons occupying the position of directors of the company are accustomed to act (but disregarding advice given in a professional capacity); or
 - (ii) any person who is entitled to exercise, or control the exercise of, 50% or more of the voting power at any general meeting of the company or of another company of which the company is a **subsidiary**; and
- (b) in relation to an unincorporated body of persons,—

- (i) any person in accordance with whose directions and instructions the officers of the body are accustomed to act (but disregarding advice given in a professional capacity); or
- (ii) any person who is entitled to exercise, or control the exercise of, 50% or more of the voting power on any resolution of the body;
- (c) in relation to any person, any person who has the power to appoint or remove a majority of the participants of the governing body of that person or otherwise controls or has the power to control the affairs or policies of that person,— and **control** and **controlled** have corresponding meanings

control room means the location at which **asset owners** have facilities to receive operational instructions from the **system operator** and to act on those instructions

control system means equipment that adjusts the output voltage, frequency, **MW** or **reactive power** (as the case may be) of an **asset** in response to certain aspects of **common quality** such as voltage, frequency, **MW** or **reactive power**, including speed governors and exciters

core grid means the **assets** that form part of the **core grid** as specified in the **core grid determination**

core grid determination means the determination specifying the **assets** forming part of the **core grid**, developed in accordance with clauses 12.63 to 12.69, including variations

core term means a term set out in a **default distributor agreement template** for inclusion in a **default distributor agreement** in accordance with clause 3(1)(a) of Schedule 12A.4

Clause 1.1(1) **core term**: inserted, on 20 July 2020, by clause 4(3) of the Electricity Industry Participation Code Amendment (Default Distributor Agreement) 2020.

customer *[Revoked]*

Clause 1.1(1) **customer**: revoked, on 1 November 2018, by clause 4(1) of the Electricity Industry Participation Code Amendment (Code Review Programme) 2018.

customer compensation scheme means a **default customer compensation scheme** or an **additional customer compensation scheme**

Clause 1.1(1) **customer compensation scheme**: inserted, on 1 April 2011, by clause 4(1) of the Electricity Industry Participation (Customer Compensation Schemes) Code Amendment 2011.

data logger *[Revoked]*

Clause 1.1(1) **data logger**: revoked, on 15 May 2014, by clause 4(2) of the Electricity Industry Participation (Minor Code Amendments) Code Amendment 2014.

data storage device means a device in a **metering installation**, whether or not integral to the **meter**, that—

- (a) electronically stores data and **event logs** used to provide information for the purposes of Part 15; and
- (b) makes the data and **event logs** available during an **interrogation**

Clause 1.1(1) **data storage device**: inserted, on 29 August 2013, by clause 4(1) of the Electricity Industry Participation (Metering Arrangements) Code Amendment 2011.

declaration date means the date, nominated by the **profile applicant**, on which the **Authority** must, for a particular **profile**, give written notice to every **registered participant** of the information set out in clause 13 of Schedule 15.5 for that **profile**

Clause 1.1(1) **declaration date**: amended, on 5 October 2017, by clause 4(15) of the Electricity Industry Participation Code Amendment (Code Review Programme) 2017.

decommissioning means—

- (a) the permanent removal from service of—
 - (i) an **asset**; or
 - (ii) a **point of connection**; or
 - (iii) a **metering installation** associated with a **point of connection**; or
- (b) for the purposes of Parts 11 and 15, the permanent removal of a **point of connection** by—
 - (i) permanently removing an **electrical facility** associated with the **point of connection**; or
 - (ii) changing the allocation of electrical loads between **points of connection** with the effect of making the **point of connection** obsolete; or
 - (iii) in the case of a **distributor-only ICP** for an **embedded network**, the **embedded network** ceasing to exist

and **decommission** and **decommissioned** have corresponding meanings

Clause 1.1(1) **decommissioning**: inserted, on 29 August 2013, by clause 4(1) of the Electricity Industry Participation (Metering Arrangements) Code Amendment 2011.

Clause 1.1(1) **decommissioning**, paragraph (a): replaced, on 5 October 2017, by clause 4(16) of the Electricity Industry Participation Code Amendment (Code Review Programme) 2017.

Clause 1.1(1) **decommissioning**, paragraph (b)(i): amended, on 1 March 2024, by clause 4(5) of the Electricity Industry Participation Code Amendment (Code Review Programme) 2024.

de-energisation [*Revoked*]

Clause 1.1(1) **de-energisation**: amended, on 29 August 2013, by clause 4(2)(i) of the Electricity Industry Participation (Metering Arrangements) Code Amendment 2011.

Clause 1.1(1) **de-energisation**: amended, on 1 February 2016, by clause 4(6) of the Electricity Industry Participation Code Amendment (Code Review Programme) 2015.

Clause 1.1(1) **de-energisation**: revoked, on 5 October 2017, by clause 4(60) of the Electricity Industry Participation Code Amendment (Code Review Programme) 2017.

de-energise [*Revoked*]

Clause 1.1(1) **de-energise**: inserted, on 29 August 2013, by clause 4(3) of the Electricity Industry Participation (Metering Arrangements) Code Amendment 2013.

Clause 1.1(1) **de-energise**: revoked, on 1 February 2016, by clause 4(2) of the Electricity Industry Participation Code Amendment (Code Review Programme) 2015.

default customer compensation scheme means a scheme that complies with clause 9.24

Clause 1.1(1) **default customer compensation scheme**: inserted, on 1 April 2011, by clause 4(1) of the Electricity Industry Participation (Customer Compensation Schemes) Code Amendment 2011.

default distributor agreement means an agreement that a **distributor** is required to develop in accordance with clauses 3 to 11 of Schedule 12A.4, and which includes—

- (a) **core terms**; and
- (b) **operational terms**; and
- (c) **recorded terms** (whether or not those terms are included in the **default distributor agreement** published in accordance with clause 6(1) or 12(1) of Schedule 12A.4); and
- (d) **collateral terms** (if any); and
- (e) any terms required in accordance with clause 3(1)(d) of Schedule 12A.4

Clause 1.1(1) **default distributor agreement**: inserted, on 20 July 2020, by clause 4(3) of the Electricity Industry Participation Code Amendment (Default Distributor Agreement) 2020.

default distributor agreement template means a template agreement set out in an appendix to Schedule 12A.4

Clause 1.1(1) **default distributor agreement template**: inserted, on 20 July 2020, by clause 4(3) of the Electricity Industry Participation Code Amendment (Default Distributor Agreement) 2020.

default interest rate means the **bank bill bid rate** plus 5% per annum

default transmission agreement means a binding contract between **Transpower** and a **designated transmission customer** for the connection to and/or use of the **grid**, that applies under clause 12.10 or 12.13 and which is based on the **default transmission agreement template**

Clause 1.1(1) **default transmission agreement**: inserted, on 1 October 2023, by clause 4(1) of the Electricity Industry Participation Code Amendment (Default Transmission Agreement) 2023.

default transmission agreement template means the template agreement set out in Schedule 12.6

Clause 1.1(1) **default transmission agreement template**: inserted, on 1 October 2023, by clause 4(1) of the Electricity Industry Participation Code Amendment (Default Transmission Agreement) 2023.

demand means the rate of consumption of electrical energy

designated transmission customers means **participants** who are required to enter into **transmission agreements** with **Transpower** under subpart 2 of Part 12

difference bid means the information that a **purchaser** submits to the **system operator** under clause 13.7AA to indicate a reasonable estimate of an increase or decrease in the **purchaser's** usual **non-dispatch-capable load** purchased at a **conforming GXP**

Clause 1.1(1) **difference bid**: inserted, on 28 June 2012, by clause 4(a) of the Electricity Industry Participation (Demand-side Bidding and Forecasting) Code Amendment 2011.

Clause 1.1(1) **difference bid**: substituted, on 15 May 2014, by clause 5(2) of the Electricity Industry Participation (Modified Dispatchable Demand) Code Amendment 2013.

Clause 1.1(1) **difference bid**: amended, on 29 June 2017, by clause 4(2) of the Electricity Industry Participation Code Amendment (Shortened Gate Closure and Revised Bid and Offer Provisions) 2017.

direct consumer means a **consumer** with a **point of connection** to the **grid**

direct purchaser means a **consumer** who purchases, or agrees to purchase, **electricity** directly from the **clearing manager** for its own consumption at a **point of connection**

disclosed [*Revoked*]

Clause 1.1(1) **disclosed**: revoked, on 16 December 2013, by clause 4(2)(b) of the Electricity Industry Participation (Revocation of Part 16) Code Amendment 2013.

disclosing participant means any of the following:

- (a) a person who consumes **electricity** that is conveyed to the person directly from the national **grid**;
- (b) a person who buys **electricity** from the **clearing manager**

Clause 1.1(1) **disclosing participant**: inserted, on 1 December 2011, by clause 4 of the Electricity Industry Participation Code (Spot Price Risk Disclosure) Amendment 2011.

disclosure information, in relation to a **participant**, means information that—

- (a) is about the **participant**; and
- (b) is held by the **participant**; and

- (c) the **participant** expects, or ought reasonably to expect, if made available to the public, will, or is likely to, have a material impact on prices in the **wholesale market**

Clause 1.1(1) **disclosure information**: inserted, on 1 October 2013, by clause 4(1) of the Electricity Industry Participation (Disclosure Obligations) Code Amendment 2013.

Clause 1.1(1) **disclosure information**: amended, on 5 October 2017, by clause 4(17) of the Electricity Industry Participation Code Amendment (Code Review Programme) 2017.

Clause 1.1(1) **disclosure information**: paragraph (c) amended, on 6 April 2021, by clause 4 of the Electricity Industry Participation Code Amendment (Definition of Disclosure Information) 2021.

Clause 1.1(1) **disclosure information**: paragraph (c) amended, on 15 December 2021, by clause 4 of the Electricity Industry Participation Code Amendment (Definition of Disclosure Information (No. 2)) 2021.

disconnected [*Revoked*]

Clause 1.1(1) **disconnected**: amended, on 23 February 2015, by clause 75 of the Electricity Industry Participation Code Amendment (Distributed Generation) 2014.

Clause 1.1(1) **disconnected**: revoked, on 5 October 2017, by clause 4(60) of the Electricity Industry Participation Code Amendment (Code Review Programme) 2017.

discretionary demand means the quantity of **demand** that a **connected asset owner** estimates will be available for use by the **system operator** under a **grid emergency**. For the avoidance of doubt, the available **discretionary demand** must exclude—

- (i) **discretionary demand** a **connected asset owner** intends to use for its own network demand management purposes; and
- (ii) any **discretionary demand** offered into the **instantaneous reserves** market; and
- (iii) any **discretionary demand** bid or offered on behalf of a **dispatch-capable load station** or **dispatch notification purchaser** or **dispatch notification generator**.

Clause 1.1(1) **discretionary demand**: inserted, on 3 May 2023, by clause 4 of the Electricity Industry Participation Code Amendment (Discretionary Demand Control) 2023.

dispatch means the process of—

- (a) pre-dispatch scheduling, to match expected **supply** with expected **demand**, and to allocate **ancillary service offers** and **transmission offers** to match expected **grid** conditions; and
- (b) rescheduling to meet forecast **demand**; and
- (c) issuing instructions and notifications based on the **dispatch schedule** and the real-time conditions to manage resources to meet the actual **demand**,—

and **dispatching** and **dispatched** have a corresponding meaning

Clause 1.1(1) **dispatch** paragraphs (a) and (c): amended, on 28 June 2012, by clause 4(d) of the Electricity Industry Participation (Demand-side Bidding and Forecasting) Code Amendment 2011.

Clause 1.1(1) **dispatch**: amended, on 1 November 2022, by clause 4(3) of the Electricity Industry Participation Code Amendment (Real Time Pricing) 2022.

dispatch arc flows [*Revoked*]

Clause 1.1(1) **dispatch arc flows**: revoked, on 28 June 2012, by clause 4(i) of the Electricity Industry Participation (Demand-side Bidding and Forecasting) Code Amendment 2011.

dispatch group constraint arc flows [*Revoked*]

Clause 1.1(1) **dispatch group constraint arc flows**: revoked, on 28 June 2012, by clause 4(i) of the Electricity Industry Participation (Demand-side Bidding and Forecasting) Code Amendment 2011.

dispatch instruction means an instruction issued by the **system operator** under clause 13.72(1)(a)

Clause 1.1(1) **dispatch instruction**: substituted, on 15 May 2014, by clause 5(2) of the Electricity Industry Participation (Modified Dispatchable Demand) Code Amendment 2013.

Clause 1.1(1) **dispatch instruction**: amended, on 1 November 2022, by clause 4(4) of the Electricity Industry Participation Code Amendment (Real Time Pricing) 2022.

dispatch marginal location factor means the factor that is determined by dividing the **dispatch price** at any **grid exit point** or **grid injection point** by the **dispatch price** at the relevant **reference point**

Clause 1.1(1) **dispatch marginal location factor**: inserted, on 1 November 2022, by clause 4(1) of the Electricity Industry Participation Code Amendment (Real Time Pricing) 2022.

dispatch notification means a notification to a **dispatch notification purchaser** or **dispatch notification generator** made by the **system operator** under clause 13.72(1)(b)

Clause 1.1(1) **dispatch notification**: inserted, on 1 November 2022, by clause 4(1) of the Electricity Industry Participation Code Amendment (Real Time Pricing) 2022.

dispatch notification generator means a **generator** that is approved by the **system operator** under clause 13.3F to be a **dispatch notification generator**

Clause 1.1(1) **dispatch notification generator**: inserted, on 1 November 2022, by clause 4(1) of the Electricity Industry Participation Code Amendment (Real Time Pricing) 2022.

dispatch notification purchaser means for the purposes of Part 1 and Part 13 only, a **dispatchable load purchaser** that is approved by the **system operator** under Schedule 13.8 to operate a **dispatch-capable load station** as a **dispatch notification purchaser**. For the purpose of this definition and for the purpose of all references to **purchaser** in relation to a **dispatch notification purchaser**, **purchaser** includes a load aggregator

Clause 1.1(1) **dispatch notification purchaser**: inserted, on 1 November 2022, by clause 4(1) of the Electricity Industry Participation Code Amendment (Real Time Pricing) 2022.

Clause 1.1(1) **dispatch notification purchaser**: amended, on 1 March 2024, by clause 4(1) of the Electricity Industry Participation Code Amendment (Dispatch Notification Enhancement and Clarifications) 2024.

dispatch objective means the objective defined in clause 13.57

dispatch price means a price in dollars and cents for each **grid injection point**, each **grid exit point**, and each **reference point**, as specified in the **dispatch schedule**

Clause 1.1(1) **dispatch price**: inserted, on 1 November 2022, by clause 4(1) of the Electricity Industry Participation Code Amendment (Real Time Pricing) 2022.

dispatch prices *[Revoked]*

Clause 1.1(1) **dispatch prices**: revoked, on 28 June 2012, by clause 4(i) of the Electricity Industry Participation (Demand-side Bidding and Forecasting) Code Amendment 2011.

dispatch quantities *[Revoked]*

Clause 1.1(1) **dispatch quantities**: revoked, on 28 June 2012, by clause 4(i) of the Electricity Industry Participation (Demand-side Bidding and Forecasting) Code Amendment 2011.

dispatch reserve price means a price in dollars and cents for **fast instantaneous reserve** and **sustained instantaneous reserve** for each **island**, as specified in the **dispatch schedule**

Clause 1.1(1) **dispatch reserve price**: inserted, on 1 November 2022, by clause 4(1) of the Electricity Industry Participation Code Amendment (Real Time Pricing) 2022.

dispatch schedule means the schedule produced by the **system operator** under clause 13.69A

Clause 1.1(1) **dispatch schedule**: substituted, on 15 May 2014, by clause 5(2) of the Electricity Industry Participation (Modified Dispatchable Demand) Code Amendment 2013.

dispatchable load information means the **volume information**—

- (a) of each **dispatch-capable load station** for each **trading period** in a **consumption period**; and
- (b) that is—
 - (i) prepared under clause 15.5A or 15.5B; and
 - (ii) aggregated and rounded in accordance with clause 15.5C

Clause 1.1(1) **dispatchable load information**: inserted, on 15 May 2014, by clause 5(1) of the Electricity Industry Participation (Modified Dispatchable Demand) Code Amendment 2013.

dispatchable load purchaser means a **purchaser** that purchases **electricity** for a **dispatch-capable load station** and, for the purposes of Parts 1 and 13 only, includes a **dispatch notification purchaser**. For clarity, other than in Parts 1 and 13, a **dispatch notification purchaser** is not a **dispatchable load purchaser**

Clause 1.1(1) **dispatchable load purchaser**: inserted, on 15 May 2014, by clause 5(1) of the Electricity Industry Participation (Modified Dispatchable Demand) Code Amendment 2013.

Clause 1.1(1) **dispatchable load purchaser**: amended, on 1 March 2024, by clause 4(2) of the Electricity Industry Participation Code Amendment (Dispatch Notification Enhancement and Clarifications) 2024.

dispatch-capable load station means a device or a group of devices approved as a **dispatch-capable load station** under clause 13.3A

Clause 1.1(1) **dispatch-capable load station**: inserted, on 15 May 2014, by clause 5(1) of the Electricity Industry Participation (Modified Dispatchable Demand) Code Amendment 2013.

dispatch-capable load station identifier means a unique code—

- (a) assigned to a **dispatch-capable load station** under clause 6(2) of Schedule 13.8; and
- (b) that is used to identify the **dispatch-capable load station** and the **GXP** at which **nominated bids** are to be submitted for that **dispatch-capable load station**

Clause 1.1(1) **dispatch-capable load station identifier**: inserted, on 15 May 2014, by clause 5(1) of the Electricity Industry Participation (Modified Dispatchable Demand) Code Amendment 2013.

Clause 1.1(1) **dispatch-capable load station identifier**: amended, on 1 March 2024, by clause 4(3) of the Electricity Industry Participation Code Amendment (Dispatch Notification Enhancement and Clarifications) 2024.

dispatched purchaser means a **dispatchable load purchaser**,—

- (a) issued with a **dispatch instruction** under clause 13.72(1)(a)(iii) for 1 or more **dispatch-capable load stations**; or
- (b) issued with a **dispatch instruction** in accordance with backup procedures under clause 13.81 for 1 or more **dispatch-capable load stations**

Clause 1.1(1) **dispatched purchaser**: inserted, on 15 May 2014, by clause 5(1) of the Electricity Industry Participation (Modified Dispatchable Demand) Code Amendment 2013.

Clause 1.1(1) **dispatched purchaser**: amended, on 1 November 2022, by clause 4(5) of the Electricity Industry Participation Code Amendment (Real Time Pricing) 2022.

dispensation means an exclusion from compliance with an **AOPO** or **technical code** granted by the **system operator** in accordance with the process set out in clauses 8.29 to 8.31

distributed generation means **generating plant** that is connected, or that a **distributed generator** proposes to connect, to a **distribution network** or to a **consumer installation** that is connected to a **distribution network**, but does not include—

- (a) **generating plant** that is connected, or that a **participant** proposes to connect, to a **distribution network** and that is operated by a **distributor** for the purpose of maintaining or restoring the provision of **electricity** to part or all of the **distributor's distribution network**—

- (i) as a result of a planned **distribution network** outage; or
 - (ii) as a result of an unplanned **distribution network** outage; or
 - (iii) during a period when the **distribution network capacity** would otherwise be exceeded on part or all of the **distribution network**; or
- (b) **generating plant** that is only momentarily **synchronised**, or that a **participant** proposes only to momentarily **synchronise**, with the **distribution network** for the purpose of switching operations to start or stop the **generating plant**

Clause 1.1(1) **distributed generation**: substituted, on 23 February 2015, by clause 4(4)(b) of the Electricity Industry Participation Code Amendment (Distributed Generation) 2014.

Clause 1.1(1) **distributed generation**: replaced, on 5 October 2017, by clause 4(1)(c) of the Electricity Industry Participation Code Amendment (Code Review Programme) 2017.

distributed generator, for the purposes of Part 6, means a person who owns or operates, or intends to own or operate, **distributed generation**

Clause 1.1(1) **distributed generator**: amended, on 23 February 2015, by clause 4(5) of the Electricity Industry Participation Code Amendment (Distributed Generation) 2014.

distributed unmetered load means **unmetered load** with a single **profile** supplied across more than 1 **point of connection** to either 1 customer of a **retailer** or to 1 **direct purchaser**

Clause 1.1(1) **distributed unmetered load**: amended, on 1 November 2018, by clause 4(2) of the Electricity Industry Participation Code Amendment (Code Review Programme) 2018.

distribution has the meaning given to it by section 5 of the **Act**

Clause 1.1(1) **distribution**: inserted, on 1 February 2016, by clause 4(19) of the Electricity Industry Participation Code Amendment (Code Review Programme) 2015.

distribution network means the **electricity lines**, and **associated equipment**, owned or operated by a **distributor**

Clause 1.1(1) **distribution network**: amended, on 23 February 2015, by clause 4(6) of the Electricity Industry Participation Code Amendment (Distributed Generation) 2014.

distribution network capacity means the capacity of a **distribution network** to convey **electricity** under a range of load and **generation** conditions in accordance with **reasonable and prudent operating practice**

Clause 1.1(1) **distribution network capacity**: inserted, on 23 February 2015, by clause 4(12) of the Electricity Industry Participation Code Amendment (Distributed Generation) 2014.

distributor has the meaning given to it by section 5 of the **Act**

Clause 1.1(1) **distributor**: amended, on 21 September 2012, by clause 4(3) of the Electricity Industry Participation (Minor Amendments) Code Amendment 2012.

Clause 1.1(1) **distributor**: amended, on 23 February 2015, by clause 4(7) of the Electricity Industry Participation Code Amendment (Distributed Generation) 2014.

Clause 1.1(1) **distributor**: amended, on 24 March 2015, by clause 4(1)(h) of the Electricity Industry Participation (Settlement and Prudential Security) Code Amendment 2013.

Clause 1.1(1) **distributor**: substituted, on 1 February 2016, by clause 4(1)(b) of the Electricity Industry Participation Code Amendment (Code Review Programme) 2015.

distributor agreement means an agreement between a **distributor** and a **participant** trading on, connected to, or using the **distributor's network** or equipment connected to the **distributor's network**

Clause 1.1(1) **distributor agreement**: inserted, on 20 July 2020, by clause 4(3) of the Electricity Industry Participation Code Amendment (Default Distributor Agreement) 2020.

distributor installation details means any information, additional to **price category** and **chargeable capacity**, that may be used to calculate line charges applicable to an **ICP**

distributor kvar reference node means a notional node that represents a group of **grid exit points** within a **zone** for which a **distributor** nominates peak demand in kvar, and for which the individual kvar quantities measured at the individual **grid exit points** within the group are aggregated for **voltage support** charging purposes, as approved by the **system operator** (such approval not to be unreasonably withheld)

document, for the purposes of paragraph (b) of the definition of **publish**, and Parts 2 and 6, has the meaning given to it in section 2(1) of the Official Information Act 1982
Clause 1.1(1) **document**: amended, on 16 December 2013, by clause 4(3)(a) and (b) of the Electricity Industry Participation (Revocation of Part 16) Code Amendment 2013.

domestic consumer *[Revoked]*

Clause 1.1(1) **domestic consumer**: revoked, on 1 March 2024, by clause 4(6) of the Electricity Industry Participation Code Amendment (Code Review Programme) 2024.

draft policy statement *[Revoked]*

Clause 1.1(1) **draft policy statement**: amended, on 10 January 2013, by clause 4(1) of the Electricity Industry Participation (Policy Statement and Procurement Plan Review Process) Code Amendment 2012.

Clause 1.1(1) **draft policy statement**: revoked, on 1 August 2023, by clause 4(2) of the Electricity Industry Participation Code Amendment (System Operation Documents) 2023.

draft procurement plan *[Revoked]*

Clause 1.1(1) **draft procurement plan**: amended, on 10 January 2013, by clause 4(2) of the Electricity Industry Participation (Policy Statement and Procurement Plan Review Process) Code Amendment 2012.

Clause 1.1(1) **draft procurement plan**: revoked, on 1 August 2023, by clause 4(3) of the Electricity Industry Participation Code Amendment (System Operation Documents) 2023.

effective date, for the purposes of subpart 5 of Part 13, means the date of the first **trading period** to which a **risk management contract** applies

EIEP means an electricity information exchange protocol that sets out standard formats for the exchange or provision of information

Clause 1.1(1) **EIEP**: inserted, on 16 December 2013, by clause 4(a) of the Electricity Industry Participation (Electricity Information Exchange Protocols) Code Amendment 2013.

Clause 1.1(1) **EIEP**: amended, on 1 February 2016, by clause 4(7) of the Electricity Industry Participation Code Amendment (Code Review Programme) 2015.

EIEP12 *[Revoked]*

Clause 1.1(1) **EIEP12**: inserted, on 1 December 2011, by clause 4(a) of the Electricity Industry Participation Code (Distributor Use-of-System Agreements and Distributor Tariffs) Amendment 2011.

Clause 1.1(1) **EIEP12**: revoked, on 16 December 2013, by clause 4(b) of the Electricity Industry Participation (Electricity Information Exchange Protocols) Amendment 2013.

EIE System means an Electricity Information Exchange System being any system prescribed by the **Authority** under clause 11.32EG

Clause 1.1(1) **EIE System**: inserted, on 1 March 2020, by clause 4 of the Electricity Industry Participation Code Amendment (Requirements and Processes for Information Requests by Agents) 2020.

Clause 1.1(1) **EIE System**: amended, on 1 March 2024, by clause 4(7) of the Electricity Industry Participation Code Amendment (Code Review Programme) 2024.

electrical facility means,—

(a) *[revoked]*

(b) all fittings that form part of a system for conveying **electricity** at any point from an **ICP** to any point from which **electricity** conveyed through that system may be consumed (including any fittings that are used or designed or intended for use by any person in, or in relation to, the generation of **electricity** for that person's use

and not for supply to any other person), but does not include any electrical appliance, —

and **electrical facilities** has a corresponding meaning

Clause 1.1(1) **electrical installation paragraph (a)**: revoked, on 23 February 2015, by clause 4(8)(a) of the Electricity Industry Participation Code Amendment (Distributed Generation) 2014.

Clause 1.1(1) **electrical installation paragraph (b)**: amended, on 23 February 2015, by clause 4(8)(b) of the Electricity Industry Participation Code Amendment (Distributed Generation) 2014.

Clause 1.1(1) **electrical installation paragraph (b)**: amended, on 5 October 2017, by clause 4(18) of the Electricity Industry Participation Code Amendment (Code Review Programme) 2017.

Clause 1.1(1) **electrical facility paragraph (b)**: amended, on 1 March 2024, by clause 4(8) of the Electricity Industry Participation Code Amendment (Code Review Programme) 2024.

electrically connect means to operate a device so that **electricity** is able to flow, including through a **point of connection**, and **electrically connected**, **electrically connecting**, **electrical connection**, and similar phrases have corresponding meanings

Clause 1.1(1) **electrically connect**: inserted, on 5 October 2017, by clause 4(61) of the Electricity Industry Participation Code Amendment (Code Review Programme) 2017.

electrically connecting [*Revoked*]

Clause 1.1(1) **electrically connecting**: inserted, on 29 August 2013, by clause 4(2) of the Electricity Industry Participation (Metering Arrangements) Code Amendment 2011, Amendment 2013 (No 2).

Clause 1.1(1) **electrically connecting**: amended, on 23 February 2015, by clause 75 of the Electricity Industry Participation Code Amendment (Distributed Generation) 2014.

Clause 1.1(1) **electrically connecting**: revoked, on 5 October 2017, by clause 4(60) of the Electricity Industry Participation Code Amendment (Code Review Programme) 2017.

electrically disconnect means to operate a device so that **electricity** is unable to flow, including through a **point of connection**, and **electrically disconnected**, **electrically disconnecting**, **electrical disconnection**, and similar phrases have corresponding meanings

Clause 1.1(1) **electrically disconnect**: inserted, on 5 October 2017, by clause 4(61) of the Electricity Industry Participation Code Amendment (Code Review Programme) 2017.

electricity means electrical energy measured in kilowatt-hours (kWh)

electricity supplied means, for any particular period, the information relating to the quantities of **electricity** supplied by **retailers** across **points of connection** to **consumers**, sourced directly from the **retailer's** financial records, including quantities—

- (a) that are metered or unmetered; and
- (b) supplied through normal customer supply and billing arrangements; and
- (c) supplied under sponsorship arrangements; and
- (d) supplied under any other arrangement

Clause 1.1(1) **electricity supplied**: amended, on 1 November 2018, by clause 4(3) of the Electricity Industry Participation Code Amendment (Code Review Programme) 2018.

electronic signature has the meaning given to it in section 209 of the Contract and Commercial Law Act 2017

Clause 1.1(1) **electronic signature**: inserted, on 1 March 2020, by clause 4 of the Electricity Industry Participation Code Amendment (Requirements and Processes for Information Requests by Agents) 2020.

embedded generating station means 1 or more **generating units** that are directly connected to a **local network** or an **embedded network** and that injects into a **local network** or an **embedded network** at a single point of **injection**

Clause 1.1(1) **embedded generating station**: amended, on 23 February 2015, by clause 75 of the Electricity Industry Participation Code Amendment (Distributed Generation) 2014.

Clause 1.1(1) **embedded generating station**: amended, on 5 October 2017, by clause 4(19) of the Electricity Industry Participation Code Amendment (Code Review Programme) 2017.

embedded generator means a **generator** who owns or operates 1 or more **embedded generating stations**

embedded network means equipment that is used, designed or intended for use in, or in connection with, the conveyance of **electricity**, and that—

- (a) is indirectly connected to the **grid** through 1 or more other **networks**; and
- (b) has 1 or more **ICP identifiers** recorded in the **registry** as being connected to it

Clause 1.1(1) **embedded network**: amended, on 1 February 2016, by clause 4(1)(c) of the Electricity Industry Participation Code Amendment (Code Review Programme) 2015.

Clause 1.1(1) **embedded network**: replaced, on 5 October 2017, by clause 4(20) of the Electricity Industry Participation Code Amendment (Code Review Programme) 2017.

Clause 1.1(1) **embedded network**: amended, on 1 March 2024, by clause 4(9) of the Electricity Industry Participation Code Amendment (Code Review Programme) 2024.

emergency management policy means the emergency management policy that is incorporated by reference in this Code under clause 7.4

EMP departure situation means any situation in which the **system operator** believes on reasonable grounds that complying with the **emergency management policy** will not—

- (a) adequately mitigate an emergency situation; or
- (b) minimise risk to public safety or significant damage to **assets**

Clause 1.1(1) **EMP departure situation**: inserted, on 21 September 2012, by clause 4(4) of the Electricity Industry Participation (Minor Amendments) Code Amendment 2012.

end date, for the purposes of subpart 5 of Part 13, means the date of the final **trading period** to which the **risk management contract** applies

energisation *[Revoked]*

Clause 1.1(1) **energisation**: inserted, on 29 August 2013, by clause 4(1) of the Electricity Industry Participation (Metering Arrangements) Code Amendment 2011.

Clause 1.1(1) **energisation**: substituted, on 29 August 2013, by clause 4(1) of the Electricity Industry Participation (Metering Arrangements) Code Amendment 2011, Amendment 2013 (No 2).

Clause 1.1(1) **energisation** paragraph (b): revoked, on 1 February 2016, by clause 4(8) of the Electricity Industry Participation Code Amendment (Code Review Programme) 2015.

Clause 1.1(1) **energisation**: revoked, on 5 October 2017, by clause 4(60) of the Electricity Industry Participation Code Amendment (Code Review Programme) 2017.

energy storage system means all equipment functioning together as a single entity that is able to take **electricity** from a **network**, store the energy in another form, and provide **injection**

Clause 1.1(1) **energy storage system**: inserted, on 3 May 2022, by clause 4(1) of the Electricity Industry Participation Code Amendment (Enabling Energy Storage Systems to Offer Instantaneous Reserve) 2022.

equivalence arrangement means an arrangement put in place in accordance with the process set out in clauses 8.29 and 8.30

equivalent day *[Revoked]*

Clause 1.1(1) **equivalent day**: revoked, on 1 November 2022, by clause 4(2) of the Electricity Industry Participation Code Amendment (Real Time Pricing) 2022.

error claimant *[Revoked]* Clause 1.1(1) **error claimant**: revoked, on 1 November 2022, by clause 4(2) of the Electricity Industry Participation Code Amendment (Real Time Pricing) 2022.

error compensation means the application of a predetermined **adjustment** or process to the data within or obtained from, a **metering component** or **metering installation** in order to correct such data for known errors in any **metering component**

Clause 1.1(1) **error compensation**: amended, on 29 August 2013, by clause 4(2)(j) of the Electricity Industry Participation (Metering Arrangements) Code Amendment 2011.

estimated reading means a value, used in the place of a **meter reading**, that is—

- (a) created using an estimation algorithm; and
- (b) not a **validated meter reading**

event charge means the amount calculated under clause 8.64

event date, in relation to an **ICP**, means the earlier of the following dates:

- (a) the date on which the gaining **trader** commences trading **electricity** at the **ICP** under clauses 1(1), 8(1) or 13(1) of Schedule 11.3:
- (b) the date on which the gaining **trader** otherwise assumes responsibility under clause 11.18(1) for the **ICP**

Clause 1.1(1) **event date**: substituted, on 1 February 2016, by clause 4(1)(d) of the Electricity Industry Participation Code Amendment (Code Review Programme) 2015.

event log means an automatically generated record of activity in a **data storage device**, that can be extracted or manually read as part of an **interrogation**

Clause 1.1(1) **event log**: inserted, on 29 August 2013, by clause 4(1) of the Electricity Industry Participation (Metering Arrangements) Code Amendment 2011.

event of default means any event listed in clause 14.41

Clause 1.1(1) **event of default**: amended, on 24 March 2015, by clause 4(1)(i) of the Electricity Industry Participation (Settlement and Prudential Security) Code Amendment 2013.

exceptional circumstances means, for the purposes of Part 15, circumstances in which access to the relevant **meter** is not achieved despite the **reconciliation participant's** best endeavours

exchange means an exchange included in a list **published** by the **Authority** on which New Zealand electricity base load futures contracts are available for trade

Clause 1.1(1) **exchange**: inserted, on 27 April 2021, by clause 4(1) of the Electricity Industry Participation Code Amendment (Hedge Market Arrangements) 2021.

excluded Code information means information—

- (a) that relates to **bids**, **offers**, **reserve offers**, or any **asset capability statement**; or
- (b) that is provided to the **Authority**, any investigator, or the **Rulings Panel** and that is required to be kept confidential under this Code or the **Act**; or
- (c) in relation to which the **Rulings Panel** has prohibited publication or communication

Clause 1.1(1) **excluded Code information** paragraph (a): substituted, on 1 October 2013, by clause 4(2) of the Electricity Industry Participation (Disclosure Obligations) Code Amendment 2013.

excluded generating station has the meaning set out in clause 8.21(1)

existing assets means transmission **assets** and **non-transmission projects** that have been **commissioned** before, and are in operation at the time of, application of a net benefits tests set out in Part 12. To avoid doubt, an investment in the expansion of generating capacity of an existing **generating unit** is not an **existing asset** or part of an **existing asset**, unless the additional generating capacity associated with the investment

has been **commissioned** before, and is in operation at the time of, the application of the relevant net benefits test

Clause 1.1(1) **existing assets**: amended, on 5 October 2017, by clause 4(21) of the Electricity Industry Participation Code Amendment (Code Review Programme) 2017.

expected interruption costs [*Revoked*]

Clause 1.1(1) **expected interruption costs**: revoked, on 7 August 2014, by clause 4(2) of the Electricity Industry Participation Code Amendment (Extended Reserve) 2014.

expected near-constraint arc flows means the scheduled quantity of energy flow on a transmission line or a transformer, if the energy flow is equal to or greater than 95% of the maximum energy flow limit (in MW) of the transmission line or transformer as set by the **system operator** in accordance with Schedule 13.3

Clause 1.1(1) **expected near-constraint arc flows**: inserted, on 28 June 2012, by clause 4(a) of the Electricity Industry Participation (Demand-side Bidding and Forecasting) Code Amendment 2011.

expected near-group-constraint arc flows means the scheduled quantity of energy flow on a group of transmission **lines** or a group of transformers or a group of transmission **lines** and transformers, calculated according to a group constraint formula covering the group, if the scheduled quantity of energy flow is equal to or above 95% of the maximum energy flow limit (in MW) for the group as set by the **system operator** in accordance with Schedule 13.3

Clause 1.1(1) **expected near-group-constraint arc flows**: inserted, on 28 June 2012, by clause 4(a) of the Electricity Industry Participation (Demand-side Bidding and Forecasting) Code Amendment 2011.

Clause 1.1(1) **expected near-group-constraint arc flows**: amended, on 1 February 2016, by clause 4(9) of the Electricity Industry Participation Code Amendment (Code Review Programme) 2015.

expected unserved energy means a forecast of the aggregate amount by which the **demand** for electricity exceeds the **supply** of electricity at each **grid exit point** as a result of likely planned or unplanned outages of **primary transmission equipment**

extended emergency situation [*Revoked*]

Clause 1.1(1) **extended emergency situation**: revoked, on 21 September 2012, by clause 4(4) of the Electricity Industry Participation (Minor Amendments) Code Amendment 2012.

export congestion means a situation in which a **distribution network** is unable to accept electricity exported from **distributed generation** because the injection of an additional unit of electricity into the **distribution network** would—

- (a) directly cause a component in the **network** to operate beyond the component's rated maximum capacity; or
- (b) give rise to an unacceptably high level of voltage at the **point of connection** between the **distribution network** and the **distributed generation**

Clause 1.1(1) **export congestion**: inserted, on 23 February 2015, by clause 4(12) of the Electricity Industry Participation Code Amendment (Distributed Generation) 2014.

Clause 1.1(1) **export congestion**: amended, on 5 October 2017, by clause 4(22) of the Electricity Industry Participation Code Amendment (Code Review Programme) 2017.

extended reserve [*Revoked*]

Clause 1.1(1) **extended reserve**: inserted, on 7 August 2014, by clause 4(3) of the Electricity Industry Participation Code Amendment (Extended Reserve) 2014.

Clause 1.1(1) **extended reserve**: revoked, on 21 December 2021, by clause 4(3) of the Electricity Industry Participation Code Amendment (Automatic Under-Frequency Load Shedding Systems) 2021.

extended reserve manager [*Revoked*]

Clause 1.1(1) **extended reserve manager**: inserted, on 7 August 2014, by clause 4(3) of the Electricity Industry Participation Code Amendment (Extended Reserve) 2014.

Clause 1.1(1) **extended reserve manager**: amended, on 5 October 2017, by clause 4(23) of the Electricity Industry Participation Code Amendment (Code Review Programme) 2017.

Clause 1.1(1) **extended reserve manager**: amended, on 20 December 2021, by clause 4(5) of the Electricity Industry Participation Code Amendment (Code Review Programme) 2019.

Clause 1.1(1) **extended reserve manager**: revoked, on 21 December 2021, by clause 4(3) of the Electricity Industry Participation Code Amendment (Automatic Under-Frequency Load Shedding Systems) 2021.

extended reserve procurement notice *[Revoked]*

Clause 1.1(1) **extended reserve procurement notice**: inserted, on 7 August 2014, by clause 4(3) of the Electricity Industry Participation Code Amendment (Extended Reserve) 2014.

Clause 1.1(1) **extended reserve procurement notice**: revoked, on 21 December 2021, by clause 4(3) of the Electricity Industry Participation Code Amendment (Automatic Under-Frequency Load Shedding Systems) 2021.

extended reserve procurement schedule *[Revoked]*

Clause 1.1(1) **extended reserve procurement schedule**: inserted, on 7 August 2014, by clause 4(3) of the Electricity Industry Participation Code Amendment (Extended Reserve) 2014.

Clause 1.1(1) **extended reserve procurement schedule**: revoked, on 21 December 2021, by clause 4(3) of the Electricity Industry Participation Code Amendment (Automatic Under-Frequency Load Shedding Systems) 2021.

extended reserve provider *[Revoked]*

Clause 1.1(1) **extended reserve provider**: inserted, on 7 August 2014, by clause 4(3) of the Electricity Industry Participation Code Amendment (Extended Reserve) 2014.

Clause 1.1(1) **extended reserve provider**: revoked, on 21 December 2021, by clause 4(3) of the Electricity Industry Participation Code Amendment (Automatic Under-Frequency Load Shedding Systems) 2021.

extended reserve schedule *[Revoked]*

Clause 1.1(1) **extended reserve schedule**: inserted, on 7 August 2014, by clause 4(3) of the Electricity Industry Participation Code Amendment (Extended Reserve) 2014.

Clause 1.1(1) **extended reserve schedule**: revoked, on 21 December 2021, by clause 4(3) of the Electricity Industry Participation Code Amendment (Automatic Under-Frequency Load Shedding Systems) 2021.

extended reserve selection methodology *[Revoked]*

Clause 1.1(1) **extended reserve selection methodology**: inserted, on 7 August 2014, by clause 4(3) of the Electricity Industry Participation Code Amendment (Extended Reserve) 2014.

Clause 1.1(1) **extended reserve selection methodology**: revoked, on 21 December 2021, by clause 4(3) of the Electricity Industry Participation Code Amendment (Automatic Under-Frequency Load Shedding Systems) 2021.

extended reserve technical requirements report *[Revoked]*

Clause 1.1(1) **extended reserve technical requirements report**: inserted, on 7 August 2014, by clause 4(3) of the Electricity Industry Participation Code Amendment (Extended Reserve) 2014.

Clause 1.1(1) **extended reserve technical requirements report**: revoked, on 21 December 2021, by clause 4(3) of the Electricity Industry Participation Code Amendment (Automatic Under-Frequency Load Shedding Systems) 2021.

extended reserve technical requirements schedule *[Revoked]*

Clause 1.1(1) **extended reserve technical requirements schedule**: inserted, on 7 August 2014, by clause 4(3) of the Electricity Industry Participation Code Amendment (Extended Reserve) 2014.

Clause 1.1(1) **extended reserve technical requirements schedule**: revoked, on 21 December 2021, by clause 4(3) of the Electricity Industry Participation Code Amendment (Automatic Under-Frequency Load Shedding Systems) 2021.

fast instantaneous reserve means the increase in generation or reduction in **demand** (in MW) provided no later than 6 seconds, and measured at 6 seconds, after the start of a “Contingent Event” (as defined in the **policy statement**) and that is sustained until at least 60 seconds after the start of the “Contingent Event”

Clause 1.1(1) **fast instantaneous reserve**: amended, on 3 May 2022, by clause 4(3)(a) of the Electricity Industry Participation Code Amendment (Enabling Energy Storage Systems to Offer Instantaneous Reserve) 2022.

final application, for the purposes of Part 6, means an application made under clause 15 of Schedule 6.1

final estimate *[Revoked]*

Clause 1.1(1) **final estimate**: revoked, on 1 November 2022, by clause 4(2) of the Electricity Industry Participation Code Amendment (Real Time Pricing) 2022.

final marginal location factor means the factor that is determined by dividing the **final price** at any **grid exit point** or **grid injection point** by the **final price** at the relevant **reference point**

final price means an **interim price** that becomes a **final price** in accordance with clause 13.182A or 13.182B

Clause 1.1(1) **final price**: amended, on 1 November 2022, by clause 4(6)(a) of the Electricity Industry Participation Code Amendment (Real Time Pricing) 2022.

final reserve price means an **interim reserve price** that becomes a **final reserve price** in accordance with clause 13.182A or 13.182B

Clause 1.1(1) **final reserve price**: amended, on 1 November 2022, by clause 4(6)(b) of the Electricity Industry Participation Code Amendment (Real Time Pricing) 2022.

financial year means, except in Part 6A and Schedule 12.4, the **financial year** adopted by a **participant** from time to time, being a 12 month period as a **participant** determines

Clause 1.1(1) **financial year**: revoked, on 5 October 2017, by clause 4(60) of the Electricity Industry Participation Code Amendment (Code Review Programme) 2017.

Clause 1.1(1) **financial year**: inserted, on 30 November 2021, by clause 4 of the Electricity Industry Participation Code Amendment (Internal Transfer Prices and Segmented Profitability Reporting) 2021.

Clause 1.1(1) **financial year**: amended, on 1 March 2024, by clause 4(10) of the Electricity Industry Participation Code Amendment (Code Review Programme) 2024.

fittings [*Revoked*]

Clause 1.1(1) **fittings**: revoked, on 23 February 2015, by clause 4(11) of the Electricity Industry Participation Code Amendment (Distributed Generation) 2014.

fixed-price physical supply contract means a contract that provides for the physical supply of **electricity**, if—

- (a) the **buyer** is reasonably expected to purchase 1 **MW** or more of **electricity** on average during the **term** of the contract (for the purposes of determining whether a contract meets this 1 **MW** threshold, the total purchases under the contract should be used despite clause 13.219(6)); and
- (b) the contract allows the **buyer** to purchase either—
 - (i) variable amounts of **electricity** linked to actual consumption of **electricity** at a fixed price or prices; or
 - (ii) a fixed amount of **electricity** at a fixed price or prices; and
- (c) excludes a contract for the physical supply of **electricity**, that is generated by an **embedded generating station**, directly to a **consumer**

flagged, in relation to a **dispatch instruction** issued to an **intermittent generator**, means an indication on the **dispatch instruction** that it is a **dispatch instruction** of the kind described in clause 13.73(1A), and **flag** has a corresponding meaning

Clause 1.1(1) **flagged**: inserted, at 12.00 pm on 19 September 2019, by clause 4(5) of the Electricity Industry Participation Code Amendment (Wind Offer Arrangements) 2019.

floating-price payer means the **party** obliged to make 1 or more payments, from time to time during the **term** of a **contract for differences**, of a floating amount for a **quantity** of **electricity**

force majeure clause, for the purposes of subpart 5 of Part 13, means a clause in a **risk management contract** under which some or all obligations may be suspended and/or the **risk management contract** may terminate due to 1 or more events (not being events specified in a **suspension clause**) beyond the control of the **party** and that could not reasonably have been foreseen, including—

- (a) any event or circumstance occasioned by, or in consequence of, any act of God (being an event or circumstance—
 - (i) due to natural causes, directly or indirectly and exclusively without human intervention; and
 - (ii) that could not reasonably have been foreseen or if foreseen, could not reasonably have been resisted); or
- (b) strikes, lockouts, other industrial disturbances, acts of public enemy, wars, blockades, insurrections, riots, epidemics, or civil disturbances; or
- (c) the binding order of any court, government or a local authority beyond the control of the **party**

force majeure event, for the purposes of Parts 3 and 4,—

- (a) means an event or circumstance beyond the reasonable control of a **market operation service provider** or **ancillary service agent** that results in, or causes, the **market operation service provider** or **ancillary service agent** to be unable to perform any of its obligations under this Code or the Electricity Industry (Enforcement) Regulations 2010; and
- (b) includes (without limitation)—
 - (i) fire, flood, storm, earthquake, landslide, volcanic eruption, or other act of God; and
 - (ii) explosion or nuclear, biological, or chemical contamination; and
 - (iii) sabotage, terrorism, or act of war (whether declared or not); and
- (c) includes an act or omission by a party to an agreement with a **market operation service provider** (not being the **Authority**) or an **ancillary service agent** only if—
 - (i) the act or omission is a breach of an obligation under the agreement; and
 - (ii) the obligation is in all material respects the same as an obligation in the **market operation service provider agreement**, or the **ancillary service agent's agreement** with the **system operator**; and
 - (iii) the act or omission would have been a **force majeure event** if it had been an act or omission of the **market operation service provider** or **ancillary service agent** and not an act or omission of the party; and
- (d) does not include that a **market operation service provider**, **ancillary service agent**, or other person—
 - (i) is unable or unwilling to pay any amount necessary to meet the obligations under this Code or the Electricity Industry (Enforcement) Regulations 2010; or
 - (ii) is unable to pay its debts; or
 - (iii) calls a meeting for the purpose of Part 14 of the Companies Act 1993; or
 - (iv) is adjudicated bankrupt; or

- (v) in the case of a company, society, or partnership, has a receiver or statutory manager or similar person appointed in respect of it or of all or any of its assets; or
- (vi) is put into liquidation; and
- (e) does not include an event that could have been prevented by the **market operation service provider** or **ancillary service agent** by the exercise of a reasonable standard of care

Clause 1.1(1) **force majeure event**: substituted, on 1 November 2012, by clause 4 of the Electricity Industry Participation (Force Majeure) Code Amendment 2012.

forecast marginal location factor means the factor that is determined by dividing the **forecast price** at any **grid exit point** or **grid injection point** by the **forecast price** at the relevant **reference point**

forecast of generation potential means, in relation to an **intermittent generating station**, an **intermittent generator's** estimate of the **electricity** (specified in **MW**) it will generate during a **trading period**, if—

- (a) the **system operator** issues **dispatch instructions** to the **intermittent generator** for the **intermittent generating station** for the **trading period**; and
- (b) none of the **dispatch instructions** are **flagged** in accordance with clause 13.73(1A)

Clause 1.1(1) **forecast of generation potential**: inserted, at 12.00 pm on 19 September 2019, by clause 4(5) of the Electricity Industry Participation Code Amendment (Wind Offer Arrangements) 2019.

forecast price means the price for **electricity** at each **grid exit point**, each **grid injection point**, and each **reference point** scheduled in the **price-responsive schedule** or the **non-response schedule** (whichever is the case) in dollars and cents

Clause 1.1(1) **forecast prices**: substituted, on 28 June 2012, by clause 4(e) of the Electricity Industry Participation (Demand-side Bidding and Forecasting) Code Amendment 2011.

Clause 1.1(1) **forecast price**: amended, on 1 November 2022, by clause 4(6)(c) of the Electricity Industry Participation Code Amendment (Real Time Pricing) 2022.

forecast reserve prices means the prices for **fast instantaneous** and **sustained instantaneous reserve** for each **island** scheduled in the **price-responsive schedule** or the **non-response schedule** (whichever is relevant) in dollars and cents

Clause 1.1(1) **forecast reserve prices**: substituted, on 28 June 2012, by clause 4(f) of the Electricity Industry Participation (Demand-side Bidding and Forecasting) Code Amendment 2011.

formal notice means a notice issued by the **system operator** in accordance with clause 5 of **Technical Code B** of Schedule 8.3

Clause 1.1(1) **formal notice**: amended, on 1 June 2013, by clause 4(b) of the Electricity Industry Participation (Scarcity Pricing) Code Amendment 2011.

forward estimate means, in relation to non **half hour** metered **ICPs**, any **volume information** (in kWh) submitted for a part or full **consumption period** that is not an **historical estimate**

frequency fluctuation means a deviation in frequency outside the **normal band**

Clause 1.1(1) **frequency fluctuation**: inserted, on 19 May 2016, by clause 4(2) of the Electricity Industry Participation Code Amendment (System Operator and Alignment with Statutory Objective) 2016.

frequency keeping means an **ancillary service** that maintains the system frequency within the **normal band**

frequency keeping unit means any equipment that provides **frequency keeping services**

Clause 1.1(1) **frequency keeping unit**: inserted, on 3 October 2013, by clause 4 of the Electricity Industry Participation (Technology Neutral Language in Frequency Keeping) Code Amendment 2013.

frequency time error *[Revoked]*

Clause 1.1(1) **frequency time error**: revoked, on 19 May 2016, by clause 4(1) of the Electricity Industry Participation Code Amendment (System Operator and Alignment with Statutory Objective) 2016.

FTR means a financial transmission right created under subpart 6 of Part 13

Clause 1.1(1) **FTR**: inserted, on 1 October 2011, by clause 4(1) of the Electricity Industry Participation (Financial Transmission Rights) Code Amendment 2011.

FTR account *[Revoked]*

Clause 1.1(1) **FTR account**: inserted, on 1 October 2011, by clause 4(1) of the Electricity Industry Participation (Financial Transmission Rights) Code Amendment 2011.

Clause 1.1(1) **FTR account**: revoked, on 24 March 2015, by clause 4(1)(j) of the Electricity Industry Participation (Settlement and Prudential Security) Code Amendment 2013.

FTR acquisition cost means—

- (a) the amount a **participant** owes or is owed in respect of the acquisition of an **FTR** in an **FTR auction**; or
- (b) if an **FTR** has been assigned by the first holder of the **FTR**, the amount that becomes owing under clause 13.249(3); or
- (c) an amount described in paragraph (a) or (b) that is adjusted under clause 13.242A

Clause 1.1(1) **FTR payment**: inserted, on 1 October 2011, by clause 4(1) of the Electricity Industry Participation (Financial Transmission Rights) Code Amendment 2011.

Clause 1.1(1) **FTR payment**: amended to **FTR acquisition cost**, on 1 November 2012, by clause 4(2) of the Electricity Industry Participation (Financial Transmission Rights) Code Amendment 2012.

Clause 1.1(1) **FTR acquisition cost**: amended, on 1 November 2014, by clause 4(2) of the Electricity Industry Participation (FTR Reconfiguration Auctions) Code Amendment 2014.

Clause 1.1(1) **FTR acquisition cost**: amended, on 24 March 2015, by clause 4(1)(l) of the Electricity Industry Participation (Settlement and Prudential Security) Code Amendment 2013.

FTR allocation plan means the FTR allocation plan prepared and **published** by the **FTR manager** under clause 13.238

Clause 1.1(1) **FTR allocation plan**: inserted, on 1 October 2011, by clause 4(1) of the Electricity Industry Participation (Financial Transmission Rights) Code Amendment 2011.

FTR auction means an auction conducted by the **FTR manager** in accordance with the **FTR allocation plan** approved under subpart 6 of Part 13

Clause 1.1(1) **FTR auction**: inserted, on 1 October 2011, by clause 4(1) of the Electricity Industry Participation (Financial Transmission Rights) Code Amendment 2011.

FTR hedge value means the gross amount that becomes due and owing by the **clearing manager** or the holder of an **FTR** on the settlement of the **FTR** in accordance with the terms of the **FTR** (excluding the **FTR acquisition cost** and any amount owing under clause 13.249(4) or (7))

Clause 1.1(1) **FTR hedge value**: inserted, on 1 November 2012, by clause 4(1) of the Electricity Industry Participation (Financial Transmission Rights) Code Amendment 2012.

Clause 1.1(1) **FTR hedge value**: amended, on 24 March 2015, by clause 4(1)(k) of the Electricity Industry Participation (Settlement and Prudential Security) Code Amendment 2013.

FTR manager means the **market operation service provider** for the time being appointed as the FTR manager under this Code

Clause 1.1(1) **FTR manager**: inserted, on 1 October 2011, by clause 4(1) of the Electricity Industry Participation (Financial Transmission Rights) Code Amendment 2011.

Clause 1.1(1) **FTR payment**: inserted, on 1 October 2011, by clause 4(1) of the Electricity Industry Participation (Financial Transmission Rights) Code Amendment 2011.

Clause 1.1(1) **FTR payment**: amended to **FTR acquisition cost**, on 1 November 2012, by clause 4(2) of the Electricity Industry Participation (Financial Transmission Rights) Code Amendment 2012.

Clause 1.1(1) **FTR manager**: amended, on 5 October 2017, by clause 4(24) of the Electricity Industry Participation Code Amendment (Code Review Programme) 2017.

Clause 1.1(1) **FTR manager**: amended, on 20 December 2021, by clause 4(7) of the Electricity Industry Participation Code Amendment (Code Review Programme) 2019.

FTR period means a period for which an FTR applies

Clause 1.1(1) **FTR period**: inserted, on 1 October 2011, by clause 4(1) of the Electricity Industry Participation (Financial Transmission Rights) Code Amendment 2011.

FTR reconfiguration amount means the amount a participant that sells a reconfigured FTR—

- (a) is entitled to be paid for the **reconfigured FTR**, if the amount is positive; or
- (b) is liable to pay in respect of the **reconfigured FTR**, if the amount is negative

Clause 1.1(1) **FTR reconfiguration amount**: inserted, on 1 November 2014, by clause 4(1) of the Electricity Industry Participation (FTR Reconfiguration Auctions) Code Amendment 2014.

FTR reconfiguration auction means an FTR auction that allows a holder of an FTR to offer for sale a portion of the FTR expressed in terms of all or a specified amount of the electricity (in MW) to which the FTR relates

Clause 1.1(1) **FTR reconfiguration auction**: inserted, on 1 November 2014, by clause 4(1) of the Electricity Industry Participation (FTR Reconfiguration Auctions) Code Amendment 2014.

FTR register means the register created and operated by the FTR manager under clause 13.247

Clause 1.1(1) **FTR register**: inserted, on 1 October 2011, by clause 4(1) of the Electricity Industry Participation (Financial Transmission Rights) Code Amendment 2011.

fully calibrated certification means certification of a metering installation under clause 13(3) of Schedule 10.7

Clause 1.1(1) **fully calibrated certification**: inserted, on 29 August 2013, by clause 4(1) of the Electricity Industry Participation (Metering Arrangements) Code Amendment 2011.

fully certified metering installation means a metering installation that has been certified other than an interim certified metering installation

Clause 1.1(1) **fully certified metering installation**: inserted, on 29 August 2013, by clause 4(1) of the Electricity Industry Participation (Metering Arrangements) Code Amendment 2011.

Clause 1.1(1) **fully certified metering installation**: amended, on 20 December 2021, by clause 4(6) of the Electricity Industry Participation Code Amendment (Code Review Programme) 2019.

gaining metering equipment provider means, for the purposes of Parts 10 and 11,—

- (a) the person who a **trader** records in the **registry** as the **metering equipment provider** for each **metering installation** for a **point of connection**; or
- (b) the person with whom the **participant** responsible for ensuring there is a **metering installation** for a **point of connection** enters into an arrangement to become the **metering equipment provider** for each **metering installation** for the **point of connection**

Clause 1.1(1) **gaining metering equipment provider**: inserted, on 29 August 2013, by clause 4(1) of the Electricity Industry Participation (Metering Arrangements) Code Amendment 2011.

Clause 1.1(1) **gaining metering equipment provider**: amended, on 5 October 2017, by clause 4(25) of the Electricity Industry Participation Code Amendment (Code Review Programme) 2017.

gaining retailer means a **retailer** who has entered into an arrangement to supply **electricity** to a person where, at the time the arrangement is entered into, the person is a customer of another **retailer** (being a **losing retailer**)

Clause 1.1(1) **gaining retailer**: inserted, on 31 March 2020, by clause 4 of the Electricity Industry Participation Code Amendment (Prohibition of Save and Win-Back Approaches by Losing Retailers During a Switch Protected Period) 2020.

gate closure period, in relation to a **trading period** for which a **generator** or **ancillary service agent** has submitted an **offer** or **reserve offer**, or for which a **dispatchable load purchaser** has submitted a **nominated dispatch bid**, means—

- (a) the **trading period** to which the **offer** or **reserve offer** relates, and the **trading period** immediately preceding that **trading period** for—
 - (i) an **embedded generator**;
 - (ii) an **ancillary service agent** that is also an **embedded generator**;
 - (iii) a **dispatch notification purchaser**;
 - (iv) a **dispatch notification generator**; and
- (b) the **trading period** to which the **offer**, **reserve offer**, or **nominated dispatch bid** relates, and the 2 **trading periods** immediately preceding that **trading period**, for—
 - (i) any other **generator**;
 - (ii) any other **ancillary service agent**;
 - (iii) a **dispatchable load purchaser** (other than a **dispatch notification purchaser**)

Clause 1.1(1) **gate closure period**: inserted, on 29 June 2017, by clause 4(3) of the Electricity Industry Participation Code Amendment (Shortened Gate Closure and Revised Bid and Offer Provisions) 2017.

Clause 1.1(1) **gate closure period** paragraph (a)(ii): revoked, at 12.00 pm on 19 September 2019, by clause 4(2) of the Electricity Industry Participation Code Amendment (Wind Offer Arrangements) 2019.

Clause 1.1(1) **gate closure period**: amended, on 1 November 2022, by clause 4(6)(d) of the Electricity Industry Participation Code Amendment (Real Time Pricing) 2022.

generally available retail tariff plan—

- (a) means a retail tariff plan that a **retailer** will make available to any **consumer** (subject to credit requirements) if the **consumer** satisfies the requirements specified for the retail tariff plan relating to:
 - (i) physical location;
 - (ii) **metering** configuration;
 - (iii) **price category** code; but
- (b) does not include a retail tariff plan made available by a **retailer** only under an agreement reached as a result of the **retailer** directly contacting a **consumer** to offer a retail tariff plan that provides the **consumer** with a financial discount or other benefit when compared with any other of the **retailer's** tariff plans to which paragraph (a) applies that are available to that **consumer**

Clause 1.1(1) **generally available retail tariff plan**: inserted, on 1 February 2016, by clause 4 of the Electricity Industry Participation Code Amendment (Access to Retail Tariff Information) 2015.

generating plant means equipment collectively used for generating **electricity**

generating station means 1 or more **generating units** that are directly connected to the **grid** or to a **local network** and that inject into the **grid** or a **local network** (as the case may be) at a single point of **injection**

Clause 1.1(1) **generating station**: amended, on 23 February 2015, by clause 75 of the Electricity Industry Participation Code Amendment (Distributed Generation) 2014.

Clause 1.1(1) **generating station**: amended, on 5 October 2017, by clause 4(26) of the Electricity Industry Participation Code Amendment (Code Review Programme) 2017.

generating unit means all equipment functioning together as a single entity to produce electricity

Clause 1.1(1) **generating unit**: amended, on 20 March 2020, by clause 4(2) of the Electricity Industry Participation Code Amendment (Broadening Definitions of Generating Unit and Intermittent Generating Station) 2020

generating unit gross means the output of a **generating unit** measured or calculated at its output terminals, inclusive of any **generating unit load** supplied

Clause 1.1(1) **generating unit gross**: inserted, on 1 June 2011, by clause 4(1) of the Electricity Industry Participation (Minor Amendments) Code Amendment 2011.

generating unit load means the active and reactive power supplied or injected via connections between the **generating unit's** output terminals and its **generating unit circuit breaker**

Clause 1.1(1) **generating unit load**: inserted, on 1 June 2011, by clause 4(1) of the Electricity Industry Participation (Minor Amendments) Code Amendment 2011.

Clause 1.1(1) **generating unit load**: amended, on 23 February 2015, by clause 75 of the Electricity Industry Participation Code Amendment (Distributed Generation) 2014.

Clause 1.1(1) **generating unit load**: amended, on 5 October 2017, by clause 4(27) of the Electricity Industry Participation Code Amendment (Code Review Programme) 2017.

generating unit net means the output of a **generating unit** measured or calculated at its **point of connection**, but does not include **generating unit load** or any other active or reactive power supplied (including losses) between the **generating unit** and the **point of connection**

Clause 1.1(1) **generating unit net**: inserted, on 1 June 2011, by clause 4(1) of the Electricity Industry Participation (Minor Amendments) Code Amendment 2011.

Clause 1.1(1) **generating unit net**: amended, on 20 December 2021, by clause 4(8) of the Electricity Industry Participation Code Amendment (Code Review Programme) 2019.

generation reserve means a form of **instantaneous reserve** (including, without limitation, **partly loaded spinning reserve**, **tail water depressed reserve** and that provided by **energy storage systems**) which comprises generating capacity that is able to provide **fast instantaneous reserve** or **sustained instantaneous reserve** in accordance with the **procurement plan**.

Clause 1.1(1) **generation reserve**: inserted, on 3 May 2022, by clause 4(1) of the Electricity Industry Participation Code Amendment (Enabling Energy Storage Systems to Offer Instantaneous Reserve) 2022.

generator means, except in Part 6A, a person who owns **generating units** connected to a **network**, or any person who acts, in respect of Parts 13, 14 and 15, on behalf of any person who owns such **generating units**, and includes **embedded generators**, **intermittent generators**, **type A co-generators**, and **type B co-generators**

Clause 1.1(1) **generator**: amended, on 23 February 2015, by clause 75 of the Electricity Industry Participation Code Amendment (Distributed Generation) 2014.

Clause 1.1(1) **generator**: amended, on 27 May 2015, by clause 4(2) of the Electricity Industry Participation Code Amendment (Industrial Co-generation Dispatch Arrangements) 2015.

Clause 1.1(1) **generator**: amended, on 5 October 2017, by clause 4(28) of the Electricity Industry Participation Code Amendment (Code Review Programme) 2017.

Clause 1.1(1) **generator**: amended, on 1 March 2024, by clause 4(11) of the Electricity Industry Participation Code Amendment (Code Review Programme) 2024.

generator retailer means a **trader** who is both a **generator** and a **retailer** and in any month of the **financial year** of the **generator retailer**:

- (a) has sold to the **clearing manager** an amount of **electricity** at least equivalent to 5% of the total amount of **electricity** sold in any of those months by all **generators** who are **traders** to the **clearing manager**, as measured in **MWh**; and
- (b) was recorded in the **registry** in any of those months as being responsible for at least 5% of the total number of **ICPs** registered in the registry with an **ICP** status of “Active”,—

and, for the purposes of this definition, the terms “**trader**”, “**generator**” and “**retailer**” include any related company, as defined in section 2 of the Companies Act 1993, of a **participant** provided that the related company is a **participant**

Clause 1.1(1) **generator retailer**: inserted, on 30 November 2021, by clause 4 of the Electricity Industry Participation Code Amendment (Internal Transfer Prices and Segmented Profitability Reporting) 2021.

good electricity industry practice in relation to transmission, means the exercise of that degree of skill, diligence, prudence, foresight and economic management, as determined by reference to good international practice, which would reasonably be expected from a skilled and experienced **asset owner** engaged in the management of a transmission **network** under conditions comparable to those applicable to the **grid** consistent with applicable law, safety and environmental protection. The determination is to take into account factors such as the relative size, duty, age and technological status of the relevant transmission **network** and the applicable law

Clause 1.1(1) **good electricity industry practice**: amended, on 20 December 2021, by clause 4(9)(a) and (b) of the Electricity Industry Participation Code Amendment (Code Review Programme) 2019.

grid means the system of transmission **lines**, substations and other works, including the **HVDC link** used to connect **grid injection points** and **grid exit points** to convey **electricity** throughout the North Island and the South Island of New Zealand

Clause 1.1(1) **grid**: amended, on 23 February 2015, by clause 75 of the Electricity Industry Participation Code Amendment (Distributed Generation) 2014.

Clause 1.1(1) **grid**: amended, on 1 February 2016, by clause 4(10) of the Electricity Industry Participation Code Amendment (Code Review Programme) 2015.

Clause 1.1(1) **grid**: amended, on 5 October 2017, by clause 4(29) of the Electricity Industry Participation Code Amendment (Code Review Programme) 2017.

grid economic investment report means the report prepared under clause 12.115, either as part of **Transpower’s** annual planning report or in some other form, if the **Authority** so determines

grid emergency means a situation where—

- (a) in the reasonable opinion of the **system operator**, 1 or more of the events set out in clause 5(1) of **Technical Code B** of Schedule 8.3 has occurred, or is reasonably expected to occur and urgent action is required of the **system operator** or **participants** to alleviate the situation; or
- (b) independent action (as set out in clause 9 of **Technical Code B** of Schedule 8.3) is required of a **participant** to alleviate the situation

grid exit point and **GXP** mean any **point of connection** on the **grid**—

- (a) at which **electricity** predominantly flows out of the **grid**; or
- (b) determined as being such by the **Authority** following an application in accordance with clause 13.28,—

and such **point of connection** may, at any given time, be a **grid exit point** or a **grid injection point**, but may not be both at the same time

grid injection point and **GIP** mean any **point of connection** on the **grid** at which **electricity** predominantly flows into the **grid**. A **point of connection** may, at any given time, be a **grid injection point** or a **grid exit point**, but may not be both at the same time

grid interface means the **assets** used to make a connection to the **grid** (as the case may be), including associated protection, control and communication systems. The term includes the interface between **assets** forming part of the **grid**

Clause 1.1(1) **grid interface**: amended, on 23 February 2015, by clause 75 of the Electricity Industry Participation Code Amendment (Distributed Generation) 2014.

Clause 1.1(1) **grid interface**: amended, on 5 October 2017, by clause 4(30) of the Electricity Industry Participation Code Amendment (Code Review Programme) 2017.

grid owner means a person who owns or operates any part of the **grid**

grid reliability report means a report on grid reliability **published** by **Transpower** under clause 12.76(1)

grid reliability standards means standards for reliability of the **grid** developed in accordance with clauses 12.55 to 12.58, 12.61 and 12.62

grid zone area means a geographical area, which includes many **nodes**, as determined by the **Authority** and **published** under clause 13.221(1)

group constraint formula means the mathematical formula applied by the **system operator**, in accordance with Schedule 13.3, to constrain the energy flows on a group of transmission **lines**, transformers or both

Clause 1.1(1) **group constraint formula**: amended, on 1 February 2016, by clause 4(11) of the Electricity Industry Participation Code Amendment (Code Review Programme) 2015.

GST means goods and services tax payable under the Goods and Services Tax Act 1985

half hour means a thirty minute period ending on any hour or half hour, and **half hourly** has a corresponding meaning

half-hour metering means the process of measuring and recording information—

- (a) relating to **electricity** conveyed; and
- (b) during—
 - (i) an interval that is a **trading period**; or
 - (ii) intervals that can be aggregated to 1 **trading period**

Clause 1.1(1) **half-hour metering**: substituted, on 29 August 2013, by clause 4(2)(k) of the Electricity Industry Participation (Metering Arrangements) Code Amendment 2011.

half-hour metering information—

- (a) means information describing the quantity of **electricity** conveyed in each **trading period** that is—
 - (i) recorded directly by a **metering installation**; or
 - (ii) calculated or estimated using information recorded directly by a **metering installation**; and

- (b) in respect of a **generator** that is selling **electricity** to the **clearing manager** and other persons at the same **grid injection point** in the same **trading period**, includes the file recording the quantity of **electricity** sold to the **clearing manager** during each such **trading period** constructed in accordance with **dispatch instructions** issued by the **system operator** under this Code.

Clause 1.1(1) **half-hour metering information**: substituted, on 19 December 2014, by clause 4(2) of the Electricity Industry Participation Code Amendment (Minor Code Amendments) (No 3) 2014.

half-hour metering installation means a **metering installation** used for **half-hour metering**

Clause 1.1(1) **half-hour metering installation**: amended, on 29 August 2013, by clause 4(2)(l) of the Electricity Industry Participation (Metering Arrangements) Code Amendment 2011.

hedge settlement agreement means an agreement in a form set out in Schedule 14.4 between **participants** that provides for settlement by the **clearing manager** of payments for differences in respect of the price of **electricity**

Clause 1.1(1) **hedge settlement agreement**: amended, on 24 March 2015, by clause 4(1)(m) of the Electricity Industry Participation (Settlement and Prudential Security) Code Amendment 2013.

high spring washer price relaxation factor *[Revoked]*

Clause 1.1(1) **high spring washer price relaxation factor**: amended, on 21 September 2012, by clause 4(1) of the Electricity Industry Participation (High Spring Washer Price Situation) Code Amendment 2012.

Clause 1.1(1) **high spring washer price relaxation factor**: revoked, on 1 November 2022, by clause 4(2) of the Electricity Industry Participation Code Amendment (Real Time Pricing) 2022.

high spring washer price situation *[Revoked]*

Clause 1.1(1) **high spring washer price situation**: amended, on 21 September 2012, by clause 4(2) of the Electricity Industry Participation (High Spring Washer Price Situation) Code Amendment 2012.

Clause 1.1(1) **high spring washer price situation**: amended, on 5 October 2017, by clause 4(31) of the Electricity Industry Participation Code Amendment (Code Review Programme) 2017.

Clause 1.1(1) **high spring washer price situation**: revoked, on 1 November 2022, by clause 4(2) of the Electricity Industry Participation Code Amendment (Real Time Pricing) 2022.

high spring washer price situation methodology *[Revoked]*

Clause 1.1(1) **high spring washer price situation methodology**: amended, on 21 September 2012, by clause 4(3) of the Electricity Industry Participation (High Spring Washer Price Situation) Code Amendment 2012.

Clause 1.1(1) **high spring washer price situation methodology**: revoked, on 1 November 2022, by clause 4(2) of the Electricity Industry Participation Code Amendment (Real Time Pricing) 2022.

high spring washer price trigger ratio *[Revoked]*

Clause 1.1(1) **high spring washer price trigger ratio**: revoked, on 1 November 2022, by clause 4(2) of the Electricity Industry Participation Code Amendment (Real Time Pricing) 2022.

high voltage terminal means the point at which the higher voltage side of a **grid owner's** transformer connects to the **grid**

Clause 1.1(1) **high voltage terminal**: amended, on 23 February 2015, by clause 75 of the Electricity Industry Participation Code Amendment (Distributed Generation) 2014.

Clause 1.1(1) **high voltage terminal**: amended, on 5 October 2017, by clause 4(32) of the Electricity Industry Participation Code Amendment (Code Review Programme) 2017.

historical annual consumption *[Revoked]*

Clause 1.1(1) **historical annual consumption**: revoked, on 1 November 2022, by clause 4(2) of the Electricity Industry Participation Code Amendment (Real Time Pricing) 2022.

historical estimate means, in relation to non **half hour** metered **ICPs**, **volume information** (in kWh)—

- (a) apportioned to part or full **consumption periods** after having applied—

- (i) the **seasonal adjustment shape**; or
 - (ii) any other **profile** that has, from time to time, been approved by the **Authority** for this purpose; or
 - (iii) any other **profile** permitted under clause 5 of Schedule 15.3; and
- (b) being 1 of the following:
- (i) the difference between 2 actual **validated meter readings**;
 - (ii) the difference between 2 **permanent estimates**;
 - (iii) any relevant **unmetered load**;
 - (iv) the difference between a **validated meter reading** and a **permanent estimate**

Clause 1.1(1) **historical estimate**: amended, on 1 February 2019, by clause 4(4) of the Electricity Industry Participation Code Amendment (Code Review Programme) 2018.

Clause 1.1(1) **historical estimate**: replaced, on 31 December 2021, by clause 4(10) of the Electricity Industry Participation Code Amendment (Code Review Programme) 2019.

hub means a **node** or group of **nodes** (and in the case of a group of **nodes**, **nodes** in the group may be given different weightings) identified as either hub A or hub B in an **FTR**

Clause 1.1(1) **hub**: inserted, on 1 October 2011, by clause 4(1) of the Electricity Industry Participation (Financial Transmission Rights) Code Amendment 2011.

HV, for the purposes of subparts 2, 6 and 7 of Part 12, means high voltage

HVDC component flows means the quantity of energy flow on each component of the **HVDC link** as calculated by the modelling system in accordance with the model formulation set out in the **system operator's market operation service provider agreement** (as amended from time to time)

HVDC injection point means the point at which **electricity** is injected into the North Island or the South Island from the **HVDC link**

HVDC link means the converter stations at Benmore in the South Island and Haywards in the North Island and the high voltage transmission **lines** and undersea cables linking them (and including all associated equipment)

Clause 1.1(1) **HVDC link**: amended, on 1 February 2016, by clause 4(12) of the Electricity Industry Participation Code Amendment (Code Review Programme) 2015.

HVDC link configuration means the following modes of operation of the **HVDC link**:

- (a) *[Revoked]*
- (b) Pole 2 only:
- (c) Pole 3 only:
- (d) *[Revoked]*
- (e) Pole 3 and Pole 2 bipole **round power**:
- (f) Pole 3 and Pole 2 bipole **not round power**

Clause 1.1 **configuration**: substituted, on 1 July 2012, by clause 4(2) of the Electricity Industry Participation (HVDC Pole 3 Minor Amendments) Code Amendment 2012.

Clause 1.1(1) **HVDC link configuration**: amended, on 1 March 2024, by clause 4(4) of the Electricity Industry Participation Code Amendment (Code Review Programme) 2024.

HVDC owner means the **grid owner** who owns and/or operates the **HVDC link**

HVDC risk offsets means the values by which HVDC flows are adjusted by the **system operator** to determine the relevant reserve risk on the **HVDC link**

ICP means an installation control point being 1 of the following:

- (a) a **point of connection** at which the **electrical facility** for a **retailer's** customer is connected to a **network** other than the **grid**;
- (b) a **point of connection** between a **network** and an **embedded network**;
- (c) a **point of connection** between a **network** and **shared unmetered load**

Clause 1.1(1) **ICP**: amended, on 23 February 2015, by clause 75 of the Electricity Industry Participation Code Amendment (Distributed Generation) 2014.

Clause 1.1(1) **ICP**: amended, on 5 October 2017, by clause 4(33) of the Electricity Industry Participation Code Amendment (Code Review Programme) 2017.

Clause 1.1(1) **ICP**: amended, on 1 November 2018, by clause 4(5) of the Electricity Industry Participation Code Amendment (Code Review Programme) 2018.

Clause 1.1(1) **ICP**: amended, on 1 March 2024, by clause 4(12) of the Electricity Industry Participation Code Amendment (Code Review Programme) 2024.

ICP day means any day when an **ICP** with the **installation type** L or B is recorded on the **registry** as having the status of Active

Clause 1.1(1) **ICP day**: amended, on 5 October 2017, by clause 4(34) of the Electricity Industry Participation Code Amendment (Code Review Programme) 2017.

ICP identifier means a unique identifier for an **ICP** created by a **distributor** in accordance with clause 1 of Schedule 11.1

identification costs means any reasonable identification and testing costs incurred by the **system operator** in accordance with clause 8.3 that are unable to be recovered from **participants** by the **system operator**

incremental costs, for the purpose of Part 6, means:

- (a) the reasonable additional costs (which include any reasonable additional transmission costs) that an efficient **distributor** would incur in providing **electricity** distribution services to **distributed generation**; minus
- (b) the **distribution** costs (which do not include any transmission costs) that an efficient **distributor** would be able to avoid as a result of the **electrical connection** of the **distributed generation**.

Clause 1.1(1) **incremental costs**: inserted, on 23 February 2015, by clause 4(12) of the Electricity Industry Participation Code Amendment (Distributed Generation) 2014.

Clause 1.1(1) **incremental costs**: amended, on 5 October 2017, by clause 4(35) of the Electricity Industry Participation Code Amendment (Code Review Programme) 2017.

Clause 1.1(1) **incremental costs**: amended, on 1 April 2023, by clause 4 of the Electricity Industry Participation Code Amendment (Avoided Cost of Transmission) 2022.

industrial co-generating station means a **generating station** that —

- (a) *[Revoked]*
- (b) is reliant on a co-located **industrial process** because—
 - (i) it derives its fuel source from that co-located **industrial process**; or
 - (ii) it provides some or all of the **electricity** that it generates to that co-located **industrial process**; or
 - (iii) it provides some or all of any by-product of generating **electricity** to that co-located **industrial process**; and
- (c) is tightly coupled to an **industrial process**; and
- (d) has been approved by the **Authority** under clause 8(1)(a) of Schedule 13.4

Clause 1.1(1) **industrial co-generating station**: amended, on 23 February 2015, by clause 75 of the Electricity Industry Participation Code Amendment (Distributed Generation) 2014.

Clause 1.1(1) **industrial co-generating station**: amended, on 27 May 2015, by clause 4(3)(a) of the Electricity Industry Participation Code Amendment (Industrial Co-generation Dispatch Arrangements) 2015.

Clause 1.1(1) **industrial co-generating station** paragraph (a): revoked, on 27 May 2015, by clause 4(3)(b) of the Electricity Industry Participation Code Amendment (Industrial Co-generation Dispatch Arrangements) 2015.

Clause 1.1(1) **industrial co-generating station** paragraph (b): amended, on 27 May 2015, by clause 4(3)(c) of the Electricity Industry Participation Code Amendment (Industrial Co-generation Dispatch Arrangements) 2015.

Clause 1.1(1) **industrial co-generating station** paragraph (c): amended, on 27 May 2015, by clause 4(3)(d) of the Electricity Industry Participation Code Amendment (Industrial Co-generation Dispatch Arrangements) 2015.

Clause 1.1(1) **industrial co-generating station** paragraph (d): amended, on 27 May 2015, by clause 4(3)(e) of the Electricity Industry Participation Code Amendment (Industrial Co-generation Dispatch Arrangements) 2015.

industrial process means a process that has a primary purpose of producing an output other than **electricity**

infeasibility situation *[Revoked]*

Clause 1.1(1) **infeasibility situation**: revoked, on 1 November 2022, by clause 4(2) of the Electricity Industry Participation Code Amendment (Real Time Pricing) 2022.

information system *[Revoked]*

Clause 1.1(1) **information system**: revoked, on 5 October 2017, by clause 4(60) of the Electricity Industry Participation Code Amendment (Code Review Programme) 2017.

inherent characteristics means the permanent and fundamental characteristics of an **asset** that are outside the reasonable control of the **asset owner** and affect the output or response of that **asset** and includes the effects of water temperature, ambient air temperature and performance during ramping on **asset** performance

initial application, for the purposes of Part 6, means an application under clause 11 of Schedule 6.1

initial estimate *[Revoked]*

Clause 1.1(1) **initial estimate**: revoked, on 1 November 2022, by clause 4(2) of the Electricity Industry Participation Code Amendment (Real Time Pricing) 2022.

injection means the flow of **electricity** into a **network**

input connection contract *[Revoked]*

Clause 1.1(1) **input connection contract**: amended, on 23 February 2015, by clause 75 of the Electricity Industry Participation Code Amendment (Distributed Generation) 2014.

Clause 1.1(1) **input connection contract**: amended, on 5 October 2017, by clause 4(36) of the Electricity Industry Participation Code Amendment (Code Review Programme) 2017.

Clause 1.1(1) **input connection contract**: revoked, on 1 April 2023, by clause 4 of the Electricity Industry Participation Code Amendment (Transmission Pricing Methodology Related Amendments) (No 2) 2022.

input information *[Revoked]*

Clause 1.1(1) **input information**: revoked, on 1 November 2022, by clause 4(2) of the Electricity Industry Participation Code Amendment (Real Time Pricing) 2022.

installation type means a category based on whether an **ICP** consumes **electricity**, generates **electricity**, or both consumes and generates **electricity**

instantaneous reserve means an **ancillary service** provided to balance the injection of **electricity** into the **grid** with the offtake of **electricity** from the **grid** following a drop in system frequency to the level specified in the **procurement plan**, comprising 1 or more of the following:

(a) **interruptible load**:

(b) **generation reserve**

Clause 1.1(1) **instantaneous reserve**: amended, on 3 May 2022, by clause 4(3)(b) of the Electricity Industry Participation Code Amendment (Enabling Energy Storage Systems to Offer Instantaneous Reserve) 2022.

interconnecting transformer means a transformer (other than a transformer that is required to supply **demand** to **distributors** or **direct consumers**) that allows for the transfer of power within the grid between any of the following voltage levels:

- (a) 220kV:
- (b) 110kV:
- (c) 66kV:
- (d) 50kV

interconnection asset, for the purposes of subparts 2, 6 and 7 of Part 12—

- (a) has the meaning set out in the **transmission pricing methodology**; and
- (b) includes the **HVDC link**

interconnection branch means an **interconnection circuit branch**, and an **interconnection transformer branch**

interconnection circuit branch means a **circuit branch** that comprises or includes **interconnection assets**

interconnection point means a **point of connection** between—

- (a) a **local network** and any other **local network**; or
- (b) an **embedded network** that is not a gateway **NSP** and a **local network**; or
- (c) an **embedded network** that is not a gateway **NSP** and any other **embedded network**

Clause 1.1(1) **interconnection point**: substituted, on 29 August 2013, by clause 4(2)(m) of the Electricity Industry Participation (Metering Arrangements) Code Amendment 2011.

interconnection transformer branch means a **transformer branch** comprising **interconnection assets**

interim certified metering installation means a **metering installation** referred to in clause 10.51(3)(a)(i)

Clause 1.1(1) **interim certified metering installation**: inserted, on 29 August 2013, by clause 4(1) of the Electricity Industry Participation (Metering Arrangements) Code Amendment 2011.

interim marginal location factor means the factor that is determined by dividing the **interim price** at any **grid exit point** or **grid injection point** by the **interim price** at the relevant **reference point**

interim price means a price in dollars and cents for each **grid injection point** and each **grid exit point**, determined in accordance with the methodology specified in clause 13.134A, and includes a revised **interim price** made available on **WITS** by the **clearing manager** under clause 13.177(b)

Clause 1.1(1) **interim price**: amended, on 1 November 2022, by clause 4(7) of the Electricity Industry Participation Code Amendment (Real Time Pricing) 2022.

interim reserve price means a price in dollars and cents for **fast instantaneous reserve** and **sustained instantaneous reserve**, determined in each **island** in accordance with the methodology specified in clause 13.134A, and includes a revised **interim reserve price** made available on **WITS** by the **clearing manager** under clause 13.177(b)

Clause 1.1(1) **interim reserve price**: amended, on 5 October 2017, by clause 4(37) of the Electricity Industry Participation Code Amendment (Code Review Programme) 2017.

Clause 1.1(1) **interim reserve price**: amended, on 1 November 2022, by clause 4(8) of the Electricity Industry Participation Code Amendment (Real Time Pricing) 2022.

intermittent generating station means a **generating station** that relies on a variable resource that is not stored and in respect of which a **generator** has not been approved by the **system operator** under clause 13.3F as a **dispatch notification generator**

Clause 1.1(1) **intermittent generating station**: amended, on 20 March 2020, by clause 4(3) of the Electricity Industry Participation Code Amendment (Broadening Definitions of Generating Unit and Intermittent Generating Station) 2020

Clause 1.1(1) **intermittent generating station**: amended, on 1 November 2022, by clause 4(9) of the Electricity Industry Participation Code Amendment (Real Time Pricing) 2022.

intermittent generator means the owner of an **intermittent generating station**. To avoid doubt, clauses referring to an **intermittent generator** apply only to the **intermittent generating stations** owned by the **intermittent generator**

interposed arrangement means an arrangement between a **distributor** and a **trader** under which the **distributor**—

- (a) conveys electricity to 1 or more **consumers** on the **distributor's network**; and
- (b) does not have a contract in respect of the conveyance of **electricity** with that **consumer** or those **consumers**

Clause 1.1(1) **interposed arrangement**: inserted, on 20 July 2020, by clause 4(3) of the Electricity Industry Participation Code Amendment (Default Distributor Agreement) 2020.

interrogation means the extraction or manual reading of stored data from a **metering installation** and **interrogated** and **interrogating** have corresponding meanings

Clause 1.1(1) **interrogation**: amended, on 29 August 2013, by clause 4(2)(n) of the Electricity Industry Participation (Metering Arrangements) Code Amendment 2011.

interruptible load means a form of **instantaneous reserve** comprised of **demand** that is able to be reduced to provide **fast instantaneous reserve** or **sustained instantaneous reserve** following a drop in system frequency, in accordance with the **procurement plan**

Clause 1.1(1) **interruptible load**: amended, on 5 October 2017, by clause 4(38) of the Electricity Industry Participation Code Amendment (Code Review Programme) 2017.

Clause 1.1(1) **interruptible load**: amended, on 3 May 2022, by clause 4(3)(c) of the Electricity Industry Participation Code Amendment (Enabling Energy Storage Systems to Offer Instantaneous Reserve) 2022.

interruptible load group GXP means the **grid exit point**, as approved by the **system operator** (such approval not to be unreasonably withheld), at which a **reserve offer** for **interruptible load** comprises the aggregate quantity of **interruptible load** available at a number of specified **grid exit points** for the purposes of **offer** and **dispatch**

interruption, for the purposes of Part 12, means an interruption in the conveyance of **electricity** between **assets** owned or operated by a **designated transmission customer** and the **grid assets** owned by **Transpower** at a **point of connection**, other than an interruption by reason of **Transpower** being directed to **electrically disconnect a point of connection** by the **Authority** or the **Rulings Panel** under the **Act** or this Code or by any other person authorised to do so by this Code

Clause 1.1(1) **interruption**: amended, on 5 October 2017, by clause 4(39) of the Electricity Industry Participation Code Amendment (Code Review Programme) 2017.

investment contracts means contracts for investments that are agreed between **Transpower** and a **designated transmission customer**

island means the South Island or the North Island of New Zealand (as the case may be)

island GWAP *[Revoked]*

Clause 1.1(1) **island GWAP**: inserted, on 1 June 2013, by clause 4(a) of the Electricity Industry Participation (Scarcity Pricing) Code Amendment 2011.

Clause 1.1(1) **island GWAP**: revoked, on 1 November 2022, by clause 4(2) of the Electricity Industry Participation Code Amendment (Real Time Pricing) 2022.

island scarcity pricing situation *[Revoked]*

Clause 1.1(1) **island scarcity pricing situation**: inserted, on 1 June 2013, by clause 4(a) of the Electricity Industry Participation (Scarcity Pricing) Code Amendment 2011.

Clause 1.1(1) **island scarcity pricing situation**: revoked, on 1 November 2022, by clause 4(2) of the Electricity Industry Participation Code Amendment (Real Time Pricing) 2022.

island shortage situation *[Revoked]*

island shortage situation: inserted, on 1 June 2013, by clause 4(a) of the Electricity Industry Participation (Scarcity Pricing) Code Amendment 2011.

Clause 1.1(1) **island shortage situation**: revoked, on 1 November 2022, by clause 4(2) of the Electricity Industry Participation Code Amendment (Real Time Pricing) 2022.

ITP information means information on internal transfer pricing as described in clause 13.256

Clause 1.1(1) **ITP information**: inserted, on 30 November 2021, by clause 4 of the Electricity Industry Participation Code Amendment (Internal Transfer Prices and Segmented Profitability Reporting) 2021.

line function services has the meaning given to it by section 5 of the Act

Clause 1.1(1) **line function services**: substituted, on 1 February 2016, by clause 4(1)(e) of the Electricity Industry Participation Code Amendment (Code Review Programme) 2015.

line owner, for the purposes of the definition of **specified participant**, means a person who owns **works** that are used or intended to be used for the conveyance of **electricity**

Clause 1.1(1) **line owner**: amended, on 21 September 2012, by clause 4(5) of the Electricity Industry Participation (Minor Amendments) Code Amendment 2012.

lines has the meaning given to it by section 5 of the Act

Clause 1.1(1) **lines**: amended, on 23 February 2015, by clause 4(9) of the Electricity Industry Participation Code Amendment (Distributed Generation) 2014.

Clause 1.1(1) **lines**: substituted, on 1 February 2016, by clause 4(1)(f) of the Electricity Industry Participation Code Amendment (Code Review Programme) 2015.

livening *[Revoked]*

Clause 1.1(1) **livening**: inserted, on 29 August 2013, by clause 4(1) of the Electricity Industry Participation (Metering Arrangements) Code Amendment 2011.

Clause 1.1(1) **livening**: revoked, on 29 August 2013, by clause 4(2) of the Electricity Industry Participation (Metering Arrangements) Code Amendment 2011, Amendment 2013 (No 2).

local authority, for the purposes of Part 6, means a territorial authority within the meaning of the Local Government Act 2002

local losses means **losses** applying to the conveyance of **electricity** over a **local network** or an **embedded network**

local network means the **lines**, equipment and plant that are used to convey **electricity** between the **grid** and 1 of the following:

- (a) an **embedded generator**;
- (b) an **embedded network**;
- (c) an **ICP**

Clause 1.1(1) **local network**: amended, on 1 February 2016, by clause 4(13) of the Electricity Industry Participation Code Amendment (Code Review Programme) 2015.

location factor, for the purposes of subpart 5 of Part 13, means the location factor calculated in accordance with clause 13.221(2)

losing metering equipment provider means, for the purposes of Parts 10 and 11, the existing **metering equipment provider** responsible for each **metering installation** for a **point of connection** at which there is a **gaining metering equipment provider**

Clause 1.1(1) **losing metering equipment provider**: inserted, on 29 August 2013, by clause 4(1) of the Electricity Industry Participation (Metering Arrangements) Code Amendment 2011.

losing retailer is defined as set out in the definition of **gaining retailer**

Clause 1.1(1) **losing retailer**: inserted, on 31 March 2020, by clause 4 of the Electricity Industry Participation Code Amendment (Prohibition of Save and Win-Back Approaches by Losing Retailers During a Switch Protected Period) 2020.

loss adjusted demand [*Revoked*]

Clause 1.1(1) **loss adjusted demand**: revoked, on 1 November 2022, by clause 4(2) of the Electricity Industry Participation Code Amendment (Real Time Pricing) 2022.

loss and constraint excess means the difference between **purchaser** and **generator** payments as defined in clause 14.16

Clause 1.1(1) **loss and constraint excess**: amended, on 24 March 2015, by clause 4(1)(n) of the Electricity Industry Participation (Settlement and Prudential Security) Code Amendment 2013.

loss category means the relevant code in the schedule **published** by the **registry manager** that identifies the relevant **loss factors** that apply to **submission information** or **dispatchable load information**

Clause 1.1(1) **loss category**: amended, on 15 May 2014, by clause 5(3) of the Electricity Industry Participation (Modified Dispatchable Demand) Code Amendment 2013.

Clause 1.1(1) **loss category**: amended, on 5 October 2017, by clause 4(40) of the Electricity Industry Participation Code Amendment (Code Review Programme) 2017.

loss compensation means the application of a predetermined **adjustment** or process to the data within, or obtained from, a **metering component** or **metering installation** in order to correct such data for known **losses** in primary plant (such as power transformers and cables)

Clause 1.1(1) **loss compensation**: amended, on 29 August 2013, by clause 4(2)(o) of the Electricity Industry Participation (Metering Arrangements) Code Amendment 2011.

losses means the difference between the delivered **electricity** at a **point of connection** and the **electricity** required to be injected into an other **point of connection** in order to supply the delivered **electricity**

loss factor means the factor, identified by reference to a **loss category** within the **registry**, to be applied to **submission information** or **dispatchable load information** to obtain adjusted for **losses** information at the relevant **NSP**, which factor is—

- (a) as set out in the report to be provided by the **registry** in accordance with clause 11.26(b); or
- (b) if a report has not been provided by the **registry**, as directed by the **Authority** under clause 15.20B(3) or 15(1) of Schedule 15.4

Clause 1.1(1) **loss factor**: amended, on 15 May 2014, by clause 5(4) of the Electricity Industry Participation (Modified Dispatchable Demand) Code Amendment 2013.

loss of communication means a sustained disruption of communications between the **system operator** and 1 or more **generators**, **ancillary service agents**, North Island

connected asset owners, South Island **grid owners**, or **dispatchable load purchasers** such that operation of the **grid** is affected or is likely to be affected

Clause 1.1(1) **loss of communication**: amended, on 1 November 2018, by clause 4(6) of the Electricity Industry Participation Code Amendment (Code Review Programme) 2018.

Clause 1.1(1) **loss of communication**: amended, on 21 December 2021, by clause 4(4) of the Electricity Industry Participation Code Amendment (Automatic Under-Frequency Load Shedding Systems) 2021.

LV, for the purposes of subparts 2, 6 and 7 of Part 12, means low voltage

main protection system means a protection system that detects 1 or more types of faults and **electrically disconnects** a faulted **asset** from the **grid** with the least possible disruption to the **grid** and non-faulted **assets**

Clause 1.1(1) **main protection system**: amended, on 5 October 2017, by clause 4(41) of the Electricity Industry Participation Code Amendment (Code Review Programme) 2017.

maintain, for the purposes of Part 6, includes to repair, and **maintenance** has a corresponding meaning

major participant means—

- (a) a **generator** who is subject to **dispatch** or a **generator** with aggregated national generation capacity in excess of 30MW; or
- (b) an **ancillary service agent** providing **frequency keeping** or **instantaneous reserve**; or
- (c) a **direct purchaser**; or
- (d) a **grid owner**

Clause 1.1(1) **major participant**: inserted, on 1 April 2021, by clause 4(1) of the Electricity Industry Participation Code Amendment (Reporting on Wholesale Market Information Disclosure) 2020.

manufacturer's specification, for the purposes of Part 12, means the specifications for an **asset**, as stated by the manufacturer

market administrator *[Revoked]*

Clause 1.1(1) **market administrator**: revoked, on 5 October 2017, by clause 4(60) of the Electricity Industry Participation Code Amendment (Code Review Programme) 2017.

market operation service provider has the meaning given to it in section 5 of the Act

market operation service provider agreement means the agreement entered into between the Authority and a **market operation service provider** for the provision of services for the purposes of this Code

mass market customers means all those customers of a **generator retailer** or **retailer** who the **generator retailer** or **retailer** classifies as mass market or who are commonly understood to be **mass market customers** in accordance with standard industry practice

Clause 1.1(1) **mass market customers**: inserted, on 30 November 2021, by clause 4 of the Electricity Industry Participation Code Amendment (Internal Transfer Prices and Segmented Profitability Reporting) 2021.

materially large contract, for the purposes of subpart 7 of Part 13, has the meaning given to it by clause 13.268

Clause 1.1(1) **materially large contract**: inserted, on 19 August 2022, by clause 4(1) of the Electricity Industry Participation Code Amendment (Restrictions on Materially Large Contracts) 2022.

Clause 1.1(1) **materially large contract**: revoked, on 18 May 2023, by clause 2(2) of the Electricity Industry Participation Code Amendment (Restrictions on Materially Large Contracts) 2023.

Clause 1.1(1) **materially large contract**: inserted, on 19 May 2023, by clause 4(1) of the Electricity Industry Participation Code Amendment (Restrictions on Materially Large Contracts) 2023.

maximum continuous rating means the maximum electrical performance of an **asset** that can be maintained continuously in normal service

maximum export power means the maximum **active power** exported into the **local network** or **embedded network** at an **ICP** of a **distributed generator**, and is equal to—

- (a) the **nameplate capacity** of the **distributed generation** minus the minimum load at the **point of connection**; or
- (b) the power export limit imposed by an active export control device

Clause 1.1(1) **maximum export power**: inserted, on 1 September 2021, by clause 4(2) of the Electricity Industry Participation Code Amendment (Application for Distributed Generation) 2021. **Note:**

Paragraph maximum export power automatically revokes on the close of 1 September 2026 under clause 8 of the Electricity Industry Participation Code Amendment (Application for Distributed Generation) 2021.

maximum South Island frequency means the maximum frequency permitted in the South Island, which is 55 Hertz

measuring transformer means—

- (a) a current transformer; or
- (b) a voltage transformer; or
- (c) both a current transformer and a voltage transformer

Clause 1.1(1) **measuring transformer**: inserted, on 29 August 2013, by clause 4(1) of the Electricity Industry Participation (Metering Arrangements) Code Amendment 2011.

meter means a device that measures either or both of the following—

- (a) **active energy**;
- (b) **reactive energy**

Clause 1.1(1) **meter**: substituted, on 29 August 2013, by clause 4(2)(p) of the Electricity Industry Participation (Metering Arrangements) Code Amendment 2011.

meter reading means a **meter** register value or the equivalent, obtained from **raw meter data** or such other reading as detailed in clause 3(1) of Schedule 15.2, which is not an **estimated reading**

metering means the process used to measure **electricity** conveyed

Clause 1.1(1) **metering**: inserted, on 29 August 2013, by clause 4(1) of the Electricity Industry Participation (Metering Arrangements) Code Amendment 2011.

metering component means a component of a **metering installation** including—

- (a) a **measuring transformer**;
- (b) all wiring and intermediate terminals in the **metering installation**;
- (c) a **control device**;
- (d) a **meter**;
- (e) a **data storage device**;
- (f) a **test facility**;
- (g) a fuse;
- (h) a **circuit breaker**;
- (i) **communication equipment**;
- (j) an **error compensation device**

Clause 1.1(1) **metering component**: inserted, on 29 August 2013, by clause 4(1) of the Electricity Industry Participation (Metering Arrangements) Code Amendment 2011.

metering data means, in relation to a **metering installation**,—

- (a) all **metering records** about the **metering installation**; and
- (b) all **raw meter data** obtained from the **metering installation**

Clause 1.1(1) **metering data**: inserted, on 29 August 2013, by clause 4(1) of the Electricity Industry Participation (Metering Arrangements) Code Amendment 2011.

metering equipment owner means the **participant** who owns any or all of the items of metering equipment installed in a **metering installation**

metering equipment provider has the meaning given to it in section 5 of the **Act**

Clause 1.1(1) **metering equipment provider**: inserted, on 29 August 2013, by clause 4(1) of the Electricity Industry Participation (Metering Arrangements) Code Amendment 2011.

metering information means the quantity of **electricity** measured by a **metering installation** and adjusted for **local losses** (if relevant) to represent the equivalent amount of **electricity** at the **point of connection** with the **grid** and consolidated into a single quantity per **trading period**

metering infrastructure means, in relation to a **metering installation**,—

- (a) the **metering installation**;
- (b) if a **back office** process is necessary, the **metering equipment owner's back office** for the **metering installation**;
- (c) a system that collects and sends information to or from the **metering installation**

Clause 1.1(1) **metering infrastructure**: inserted, on 29 August 2013, by clause 4(1) of the Electricity Industry Participation (Metering Arrangements) Code Amendment 2011.

metering installation means—

- (a) equipment, including all **metering components**, used, or intended to be used, for **metering**;
- (b) in the context of **unmetered load**, the calculation process used to derive the quantity of **unmetered load**;
- (c) in the context of instances of both **metered electricity** quantities and **unmetered load**, both (a) and (b)

Clause 1.1(1) **metering installation**: substituted, on 29 August 2013, by clause 4(2)(q) of the Electricity Industry Participation (Metering Arrangements) Code Amendment 2011.

Clause 1.1(1) **metering installation**: inserted, on 1 February 2016, by clause 4(14) of the Electricity Industry Participation Code Amendment (Code Review Programme) 2015.

metering records means all specifications for, attributes of, and information relating to or concerning, a **metering installation** (other than **raw meter data**), including—

- (a) the relevant records of the **metering equipment provider** responsible for the **metering installation**;
- (b) the relevant records of each **ATH** who **certified** the **metering installation** or any **metering component** of the **metering installation**;
- (c) all factors applied in a **meter** in the **metering installation** and relating to that data (for example the k factor and m factor);
- (d) the **metering installation's** maintenance and repair history and requirements;
- (e) details of each **metering component** in the **metering installation** including information about its ownership;
- (f) all **certification reports** and supporting documents and records

Clause 1.1(1) **metering records**: inserted, on 29 August 2013, by clause 4(1) of the Electricity Industry Participation (Metering Arrangements) Code Amendment 2011.

metering situation *[Revoked]*

Clause 1.1(1) **metering situation**: substituted, on 15 May 2014, by clause 5(2) of the Electricity Industry Participation (Modified Dispatchable Demand) Code Amendment 2013.

Clause 1.1(1) **metering situation** paragraph (a)(v): inserted, on 27 May 2015, by clause 4(4) of the Electricity Industry Participation Code Amendment (Industrial Co-generation Dispatch Arrangements) 2015.

Clause 1.1(1) **metering situation** paragraph (a)(iv): amended, at 12.00 pm on 19 September 2019, by clause 3(a) and (b) of the Electricity Industry Participation Code Amendment (Wind Offer Arrangements) 2019.

Clause 1.1(1) **metering situation**: revoked, on 1 November 2022, by clause 4(2) of the Electricity Industry Participation Code Amendment (Real Time Pricing) 2022.

metering testing requirements *[Revoked]*

Clause 1.1(1) **metering testing requirements**: revoked, on 29 August 2013, by clause 4(3) of the Electricity Industry Participation (Metering Arrangements) Code Amendment 2011.

metering standards means the **metering** requirements set out in the Schedules to Part 10

Clause 1.1(1) **metering standards**: substituted, on 29 August 2013, by clause 4(2)(r) of the Electricity Industry Participation (Metering Arrangements) Code Amendment 2011.

metrology layer means a part of a **metering installation** used for either or both of the following:

- (a) measuring and recording **electricity** conveyed; or
- (b) recording **event logs**

Clause 1.1(1) **metrology layer**: inserted, on 29 August 2013, by clause 4(1) of the Electricity Industry Participation (Metering Arrangements) Code Amendment 2011.

minimum South Island frequency means the minimum frequency permitted in the South Island, which is 45 Hertz

model formulation means the model from which **software specifications** have been developed for the **system operator**

modelled projects means transmission augmentation projects and **non-transmission projects** that are reasonably expected to occur within the time period for which the assessment of costs and benefits under a net benefits test set out in Part 12 is undertaken

momentary fluctuations *[Revoked]*

Clause 1.1(1) **momentary fluctuations**: revoked, on 19 May 2016, by clause 4(1) of the Electricity Industry Participation Code Amendment (System Operator and Alignment with Statutory Objective) 2016.

MV, for the purposes of subparts 2, 6 and 7 of Part 12, means medium voltage

MW means a megawatt of electrical power

MWh means a megawatt hour of electrical energy

N-1 criterion means that, with all **assets** that are reasonably expected to be in service, the power system would be in a **secure state**

nameplate capacity means the lesser of—

- (a) the full-load continuous rating of **generating plant** under conditions specified by its designer in **MW** or kilowatts; or
- (b) the full-load continuous rating of the **generating plant's** inverter (if any) under conditions specified by its designer in **MW** or kilowatts

Clause 1.1(1) **nameplate capacity**: inserted, on 23 February 2015, by clause 4(12) of the Electricity Industry Participation Code Amendment (Distributed Generation) 2014.

national grid *[Revoked]*

Clause 1.1(1) **national grid**: revoked, on 23 February 2015, by clause 4(11) of the Electricity Industry Participation Code Amendment (Distributed Generation) 2014.

national GWAP *[Revoked]*

Clause 1.1(1) **national GWAP**: inserted, on 1 June 2013, by clause 4(a) of the Electricity Industry Participation (Scarcity Pricing) Code Amendment 2011.

Clause 1.1(1) **national GWAP**: revoked, on 1 November 2022, by clause 4(2) of the Electricity Industry Participation Code Amendment (Real Time Pricing) 2022.

national holiday means any day on which any of the following are observed as a statutory holiday:

- (a) Good Friday:
- (b) Easter Monday:
- (c) ANZAC Day:
- (d) the birthday of the reigning Sovereign (observed on the first Monday in June):
- (da) Te Rā Aro ki a Matariki/Matariki Observance Day:
- (e) Labour Day:
- (f) Christmas Day:
- (g) Boxing Day:
- (h) New Year's Day:
- (i) the day after New Year's Day:
- (j) Waitangi Day

Clause 1.1(1) **national holiday**: amended, on 1 March 2024, by clause 4(13) of the Electricity Industry Participation Code Amendment (Code Review Programme) 2024.

national scarcity pricing situation *[Revoked]*

national scarcity pricing situation: inserted, on 1 June 2013, by clause 4(a) of the Electricity Industry Participation (Scarcity Pricing) Code Amendment 2011.

Clause 1.1(1) **national scarcity pricing situation**: revoked, on 1 November 2022, by clause 4(2) of the Electricity Industry Participation Code Amendment (Real Time Pricing) 2022.

national shortage situation *[Revoked]*

national shortage situation: inserted, on 1 June 2013, by clause 4(a) of the Electricity Industry Participation (Scarcity Pricing) Code Amendment 2011.

Clause 1.1(1) **national shortage situation**: revoked, on 1 November 2022, by clause 4(2) of the Electricity Industry Participation Code Amendment (Real Time Pricing) 2022.

negative sequence voltage means a measure of difference in magnitude and phase angle in each phase

net grid exit point *[Revoked]*

Clause 1.1(1) **net grid exit point**: revoked, on 1 November 2022, by clause 4(2) of the Electricity Industry Participation Code Amendment (Real Time Pricing) 2022.

net grid injection point *[Revoked]*

Clause 1.1(1) **net grid injection point**: revoked, on 1 November 2022, by clause 4(2) of the Electricity Industry Participation Code Amendment (Real Time Pricing) 2022.

net purchase quantity assessment means the quantity of an **ancillary service** derived from the following formula:

$$a = b - c$$

where

- a is the net purchase quantity of the **ancillary service** to be procured by the **system operator** in accordance with the **procurement plan**
- b is the gross amount of an **ancillary service** that the **system operator** believes is required in order to meet the **principal performance objectives**;
- c is the amount of the **ancillary service** that is made available to the **system operator** under **alternative ancillary service arrangements**

network means, except in Part 6A, the **grid**, a **local network** or an **embedded network**

Clause 1.1(1) **network**: amended, on 1 March 2024, by clause 4(14) of the Electricity Industry Participation Code Amendment (Code Review Programme) 2024.

new investment agreement contracts means contracts entered into before 1 April 2008 between **Transpower** and its customers, under which **Transpower** agrees to provide new or upgraded plant and the customer agrees to pay charges based on **Transpower's** cost of providing the new or upgraded plant

New Zealand daylight time means New Zealand daylight time declared by Order in Council under section 4 of the Time Act 1974

New Zealand standard time has the meaning given to it by section 2 of the Time Act 1974

node means—

- (a) a bus; or
- (b) a location at which an electrical link that is not part of or does not contain a **transformer**, diverges or terminates (such as a "tee" point or a deviation); or
- (c) a point at a substation at which 2 or more electrical links join at which there is no bus

nominal voltage means the voltage at which particular equipment is designed to operate under normal circumstances

nominated bid—

- (a) *[Revoked]*
- (b) *[Revoked]*
- (c) *[Revoked]*
- (d) means the information that a **purchaser** submits to the **system operator** under clause 13.7 to indicate a reasonable estimate of the—
 - (i) **electricity** that the **purchaser** will purchase for a **dispatch-capable load station** at a **GXP**; or
 - (ii) **non-dispatch-capable load** that the **purchaser** will purchase at a **non-conforming GXP**; and
- (e) includes a deemed **nominated bid** under clause 13.8A

Clause 1.1(1) **nominated bid**: inserted, on 28 June 2012, by clause 4(a) of the Electricity Industry Participation (Demand-side Bidding and Forecasting) Code Amendment 2011.

Clause 1.1(1) **nominated bid**: amended, on 15 May 2014, by clause 5(5) of the Electricity Industry Participation (Modified Dispatchable Demand) Code Amendment 2013.

Clause 1.1(1) **nominated bid**: amended, on 19 December 2014, by clause 4(3) of the Electricity Industry Participation Code Amendment (Minor Code Amendments) (No 3) 2014.

Clause 1.1(1) **nominated bid** paragraph (d): amended, on 29 June 2017, by clause 4(4) of the Electricity Industry Participation Code Amendment (Shortened Gate Closure and Revised Bid and Offer Provisions) 2017.

nominated dispatch bid means a **nominated bid** that a **purchaser** submits to the **system operator** in relation to a **dispatch-capable load station** that the **purchaser** is making available to be **dispatched**

Clause 1.1(1) **nominated dispatch bid**: inserted, on 15 May 2014, by clause 5(1) of the Electricity Industry Participation (Modified Dispatchable Demand) Code Amendment 2013.

nominated non-dispatch bid means a **nominated bid** that a **purchaser** submits to the **system operator** in relation to—

- (a) **non-dispatch-capable load** at a **non-conforming GXP**; or
- (b) a **dispatch-capable load station** that the **purchaser** is not making available to be dispatched

Clause 1.1(1) **nominated non-dispatch bid**: inserted, on 15 May 2014, by clause 5(1) of the Electricity Industry Participation (Modified Dispatchable Demand) Code Amendment 2013.

non-conforming GXP means a **GXP** that has been determined by the **Authority** to be a **non-conforming GXP** under clause 13.27A or 13.27B(4)

Clause 1.1(1) **non-conforming GXP**: inserted, on 28 March 2012, by clause 4(a) of the Electricity Industry Participation (Demand-side Bidding and Forecasting) Code Amendment 2011.

non-dispatch-capable load means a quantity of **electricity** purchased at a **GXP** that is not purchased for 1 or more **dispatch-capable load stations**

Clause 1.1(1) **non-dispatch-capable load**: inserted, on 15 May 2014, by clause 5(1) of the Electricity Industry Participation (Modified Dispatchable Demand) Code Amendment 2013.

non half-hour metering means the process of measuring and recording information—

- (a) relating to **electricity** conveyed; and
- (b) at intervals that are greater than 1 **trading period**

Clause 1.1(1) **non half-hour metering**: inserted, on 29 August 2013, by clause 4(1) of the Electricity Industry Participation (Metering Arrangements) Code Amendment 2011.

non half-hour metering installation means a **metering installation** used for **non half-hour metering**

Clause 1.1(1) **non half-hour metering installation**: inserted, on 29 August 2013, by clause 4(1) of the Electricity Industry Participation (Metering Arrangements) Code Amendment 2011.

non-response schedule means the schedule prepared by the **system operator**—

- (a) under clause 13.58(1)(b); and
- (b) for the purpose of assisting **generators, purchasers, consumers, ancillary service agents, and grid owners** to manage their resources

Clause 1.1(1) **non-response schedule**: inserted, on 28 June 2012, by clause 4(a) of the Electricity Industry Participation (Demand-side Bidding and Forecasting) Code Amendment 2011.

non-transmission projects includes investments in any of the following:

- (a) generation;
- (b) energy efficiency;
- (c) **demand-side management**;
- (d) **local network** augmentation;
- (e) improvements to the systems and processes of the **system operator**;
- (f) the provision of **ancillary services**

normal band means a frequency band between 49.8 Hertz and 50.2 Hertz (both inclusive)

notified planned outage means the outage of an **asset** that forms part of, or is connected to, the **grid** or **local network**—

- (a) that is planned by the relevant **asset owner**; and
- (b) for which the **asset owner** has given written notice to the **system operator** in accordance with **Technical Code D** of Schedule 8.3

Clause 1.1(1) **notified planned outages**: amended, on 23 February 2015, by clause 75 of the Electricity Industry Participation Code Amendment (Distributed Generation) 2014.

Clause 1.1(1) **notified planned outages**: replaced, on 5 October 2017, by clause 4(1)(d) of the Electricity Industry Participation Code Amendment (Code Review Programme) 2017.

notify [*Revoked*]

Clause 1.1(1) **notify**: revoked, on 5 October 2017, by clause 4(60) of the Electricity Industry Participation Code Amendment (Code Review Programme) 2017.

notional embedding contracts means contracts entered into before 1 April 2008 between **Transpower** and its customers, under which a customer's generation assets are treated as if they were physically connected to load in lieu of their existing connection to the **grid**

Clause 1.1(1) **notional embedding contracts**: amended, on 23 February 2015, by clause 75 of the Electricity Industry Participation Code Amendment (Distributed Generation) 2014.

Clause 1.1(1) **notional embedding contracts**: amended, on 5 October 2017, by clause 4(43) of the Electricity Industry Participation Code Amendment (Code Review Programme) 2017.

NSP means a network supply point that is a **point of connection** between—

- (a) a **local network** and the **grid**; or
- (b) 2 **local networks**; or
- (c) a **local network** and an **embedded network**; or
- (d) 2 **embedded networks**; or
- (e) a **generator** and the **grid**

Clause 1.1(1) **network supply point**: amended, on 5 October 2017, by clause 4(42) of the Electricity Industry Participation Code Amendment (Code Review Programme) 2017.

NSP identifier means a unique identifier for an **NSP** created by the **reconciliation manager** in accordance with clause 28 of Schedule 11.1

obligation FTR means an **FTR** for which the terms and conditions provide that—

- (a) (excluding the **FTR acquisition cost**) the holder of the **FTR** is entitled to receive a payment when, for the **FTR period**, the difference between the price (calculated in accordance with the terms of the **FTR**) at the **hub** identified as hub B and the price at the **hub** identified as hub A in the **FTR** is positive; and
- (b) (excluding the **FTR acquisition cost**) the holder must make a payment when the difference between those prices is negative

Clause 1.1(1) **obligation FTR**: inserted, on 1 October 2011, by clause 4(1) of the Electricity Industry Participation (Financial Transmission Rights) Code Amendment 2011.

Clause 1.1(1) **obligation FTR**: amended, on 1 November 2012, by clause 4(3) of the Electricity Industry Participation (Financial Transmission Rights) Code Amendment 2012.

NZEF market-making agreement means an agreement between a **participant** and an **exchange** that imposes obligations on the **participant** in relation to the **exchange's** daily settlement market-making scheme for **NZ electricity futures**, in the form of agreement used on the **exchange** for this purpose that is satisfactory to the **Authority**, having regard to its inclusion of the requirements set out in clause 13.236L and of the permitted exemptions from the performance of market-making services

Clause 1.1(1) **NZEF market-making agreement**: inserted, on 3 February 2020, by clause 4 of the Electricity Industry Participation Code Amendment (Hedge Market Arrangements) 2020.

Clause 1.1(1) **NZEF market-making agreement**: revoked, on 3 November 2020 in accordance with section 40(2)(b) of the Electricity Industry Act 2010.

Clause 1.1(1) **NZEF market-making agreement**: inserted, on 27 April 2021, by clause 4(3) of the Electricity Industry Participation Code Amendment (Hedge Market Arrangements) 2021.

NZEF market-making period means from 1530 to 1600 New Zealand time on each **business day** on which **NZ electricity futures** are traded

Clause 1.1(1) **NZEF market-making period**: inserted, on 3 February 2020, by clause 4 of the Electricity Industry Participation Code Amendment (Hedge Market Arrangements) 2020.

Clause 1.1(1) **NZEF market-making period**: revoked, on 3 November 2020 in accordance with section 40(2)(b) of the Electricity Industry Act 2010.

Clause 1.1(1) **NZEF market-making period**: inserted, on 27 April 2021, by clause 4(4) of the Electricity Industry Participation Code Amendment (Hedge Market Arrangements) 2021.

NZ electricity future means a New Zealand electricity 0.1 MW base load equivalent futures contract in respect of the Otahuhu reference **node** or the Benmore reference **node** available for trade on an **exchange**

Clause 1.1(1) **NZ electricity future**: inserted, on 27 April 2021, by clause 4(1) of the Electricity Industry Participation Code Amendment (Hedge Market Arrangements) 2021.

Clause 1.1(1) **NZ electricity future**: amended, on 1 September 2022, by clause 4(1) of the Electricity Industry Participation Code Amendment (Hedge Market Arrangements) 2022.

offer means the information that a **generator** submits to the **system operator** under clause 13.6(1), and includes any revised **offer** that a **generator** submits under clauses 13.17 to 13.19

Clause 1.1(1) **offer**: amended, on 15 May 2014, by clause 4(3) of the Electricity Industry Participation (Minor Code Amendments) Code Amendment 2014.

Clause 1.1(1) **offer**: substituted, on 29 June 2017, by clause 5(a) of the Electricity Industry Participation Code Amendment (Shortened Gate Closure and Revised Bid and Offer Provisions) 2017.

offer stack [*Revoked*]

Clause 1.1(1) **offer stack**: amended, at 12.00 pm on 19 September 2019, by clause 4(4) of the Electricity Industry Participation Code Amendment (Wind Offer Arrangements) 2019.

Clause 1.1(1) **offer stack**: revoked, on 1 November 2022, by clause 4(2) of the Electricity Industry Participation Code Amendment (Real Time Pricing) 2022.

offered FTR means an **FTR** that has been offered into an **FTR reconfiguration auction**

Clause 1.1(1) **offered FTR**: inserted, on 1 November 2014, by clause 4(1) of the Electricity Industry Participation (FTR Reconfiguration Auctions) Code Amendment 2014.

official conservation campaign is a campaign to encourage **electricity** conservation that—

- (a) is commenced by the **system operator**; and
- (b) lasts for 1 week or more; and
- (c) covers—
 - (i) the South Island; or
 - (ii) all of New Zealand

Clause 1.1(1) **official conservation campaign**: inserted, on 1 April 2011, by clause 4(1) of the Electricity Industry Participation (Customer Compensation Schemes) Code Amendment 2011.

offtake means the flow of **electricity** from the **grid** at a **grid exit point**

operating account means the trust account or accounts established by the **clearing manager** in accordance with clause 14.66, and **operating accounts** has a considerable meaning

Clause 1.1(1) **operating account**: amended, on 24 March 2015, by clause 4(1)(o) of the Electricity Industry Participation (Settlement and Prudential Security) Code Amendment 2013.

Clause 1.1(1) **operating account**: amended, on 1 March 2024, by clause 4(15) of the Electricity Industry Participation Code Amendment (Code Review Programme) 2024.

operational term means a term that is described in a **default distributor agreement template** for inclusion in a **default distributor agreement** in accordance with clause 3(1)(b) of Schedule 12A.4

Clause 1.1(1) **operational term**: inserted, on 20 July 2020, by clause 4(3) of the Electricity Industry Participation Code Amendment (Default Distributor Agreement) 2020.

option FTR means an **FTR** for which the terms and conditions provide that—

- (a) (excluding the **FTR acquisition cost**) the holder of the **FTR** is entitled to receive a payment when, for the **FTR period**, the difference between the price (calculated in accordance with the terms of the **FTR**) at the **hub** identified as hub B and the price at the **hub** identified as hub A in the **FTR** is positive; but
- (b) (excluding the **FTR acquisition cost**) the holder is not required to make a payment when the difference between those prices is negative

Clause 1.1(1) **option FTR**: inserted, on 1 October 2011, by clause 4(1) of the Electricity Industry Participation (Financial Transmission Rights) Code Amendment 2011.

Clause 1.1(1) **option FTR**: amended, on 1 November 2012, by clause 4(4) of the Electricity Industry Participation (Financial Transmission Rights) Code Amendment 2012.

options contract means a contract containing the right to buy or sell a financial derivative contract

order, for the purposes of subpart 5B of Part 13, means a **quote**, or a bundle of **quotes** (at the same price) in relation to a particular month or calendar quarter, and particular reference **node** simultaneously, placed on an **exchange** by a **participant** referred to in clause 13.236K(1)

Clause 1.1(1) **order**: inserted, on 1 September 2022, by clause 4(2) of the Electricity Industry Participation Code Amendment (Hedge Market Arrangements) 2022.

other party, for the purposes of subpart 5 of Part 13, means the **party** to a **risk management contract** who did not submit information under clauses 13.219(1) to (4), 13.223(1), or 13.224, as the case may be

outage, for the purposes of Part 12, has the meaning given to it by clause 12.130

outage constraint means any **grid injection point** or **grid exit point** that has no load or generation connected to it in the modelling system, and of which the **system operator** gives written notice to the **reconciliation manager** under clause 15.15(a)

Clause 1.1(1) **outage constraint**: replaced, on 5 October 2017, by clause 4(1)(e) of the Electricity Industry Participation Code Amendment (Code Review Programme) 2017.

outage plan, for the purposes of Part 12, means the annual outage plan developed under the **Outage Protocol**

Outage Protocol, for the purposes of Part 12, means the Outage Protocol that is incorporated by reference in this Code under clause 12.150

overall accuracy [*Revoked*]

Clause 1.1(1) **overall accuracy**: revoked, on 29 August 2013, by clause 4(3) of the Electricity Industry Participation

(Metering Arrangements) Code Amendment 2011.

over frequency limit means the maximum frequency of 50.5 Hz

over frequency reserve means an **ancillary service** that comprises an automatic reduction in the level of **injection** by a generating set to arrest an unplanned rise in system frequency

Part 6A dispensation means an exclusion from compliance with Part 6A or any provisions of Part 6A granted by the **Authority** in accordance with the process set out in clause 6A.9

Clause 1.1(1) **Part 6A dispensation**: inserted, on 31 August 2023, by clause 4 of the Electricity Industry Participation Code Amendment (Part 6A Dispensation for Specified Persons) 2023.

Clause 1.1(1) **Part 6A dispensation**: replaced, on 1 March 2024, by clause 4 of the Electricity Industry Participation Code Amendment (Part 6A Dispensation for Specified Persons) 2024.

participant has the meaning given to it in section 5 of the **Act** and, for the purposes of Parts 8, 13, 14, and 14A, has the additional meaning set out in clause 1.5

Clause 1.1(1) **participant**: amended, on 5 October 2017, by clause 4(44) of the Electricity Industry Participation Code Amendment (Code Review Programme) 2017.

participant identifier means a unique 4 letter code assigned to a **participant** under clause 15.39 that is used to identify the **participant**, including in the reconciliation and **registry** processes

Clause 1.1(1) **participant identifier**: amended, on 15 May 2014, by clause 4(4) of the Electricity Industry Participation (Minor Code Amendments) Code Amendment 2014.

participant rolling outage plan means a plan developed by a **specified participant** under clauses 9.6 to 9.13

partly loaded spinning reserve means a form of **generation reserve** consisting of spare capacity, held in reserve on a **generation unit**, generating, but not operating at full output, but excludes the spare capacity provided by an **energy storage system**

Clause 1.1(1) **partly loaded spinning reserve**: amended, on 5 October 2017, by clause 4(45) of the Electricity Industry Participation Code Amendment (Code Review Programme) 2017.

Clause 1.1(1) **partly loaded spinning reserve**: amended, on 3 May 2022, by clause 4(3)(d) of the Electricity Industry Participation Code Amendment (Enabling Energy Storage Systems to Offer Instantaneous Reserve) 2022.

party, for the purposes of subpart 5 and subpart 7 of Part 13, means either the **buyer** or **seller** under a **risk management contract** or both the **buyer** and **seller** under a **risk management contract**, as the case may be, and for the purposes of subpart 7 of Part 13, means either the **buyer** or **seller** under a contract or both the **buyer** and **seller** under a contract, as the case may be

Clause 1.1(1) **party**: amended, on 19 August 2022, by clause 4(4) of the Electricity Industry Participation Code Amendment (Restrictions on Materially Large Contracts) 2022.

Clause 1.1(1) **party**: revoked, on 18 May 2023, by clause 2(2) of the Electricity Industry Participation Code Amendment (Restrictions on Materially Large Contracts) 2023.

Clause 1.1(1) **party**: inserted, on 19 May 2023, by clause 4(4) of the Electricity Industry Participation Code Amendment (Restrictions on Materially Large Contracts) 2023.

payee [*Revoked*]

Clause 1.1(1) **payee**: substituted, on 1 October 2011, by clause 4(2) of the Electricity Industry Participation (Financial Transmission Rights) Code Amendment 2011.

Clause 1.1(1) **payee**: amended, on 15 May 2014, by clause 5(6) of the Electricity Industry Participation (Modified Dispatchable Demand) Code Amendment 2013.

Clause 1.1(1) **payee**: revoked, on 24 March 2015, by clause 4(1)(p) of the Electricity Industry Participation (Settlement and Prudential Security) Code Amendment 2013.

payer [*Revoked*]

Clause 1.1(1) **payer** paragraph (iv): inserted, on 1 October 2011, by clause 4(3) of the Electricity Industry Participation (Financial Transmission Rights) Code Amendment 2011.

Clause 1.1(1) **payer**: revoked, on 24 March 2015, by clause 4(1)(q) of the Electricity Industry Participation (Settlement and Prudential Security) Code Amendment 2013.

permanent estimate means—

- (a) a value sourced from an **estimated reading** that has passed the validation process in clauses 16 and 17 of Schedule 15.2 and has been calculated from **validated meter readings**; or
- (b) if, despite using reasonable endeavours, a **reconciliation participant** cannot replace **volume information** created using **estimated readings** with **volume information** created using **validated meter readings** by the month 14 revision cycle, a value created by the **reconciliation participant** using its best estimates of **validated meter readings**

Clause 1.1(1) **permanent estimate**: replaced, on 1 February 2019, by clause 4(7) of the Electricity Industry Participation Code Amendment (Code Review Programme) 2018.

pivotal [*Revoked*]

Clause 1.1(1) **pivotal**: inserted, on 17 July 2014, by clause 4(1) of the Electricity Industry Participation Code Amendment (Pivotal Supply) 2014.

Clause 1.1(1) **pivotal**: revoked, on 30 June 2021 by clause 4 of the Electricity Industry Participation Code Amendment (Trading Conduct Provisions) 2021.

planned interruption, for the purposes of Part 12, means an **interruption** caused by a **planned outage**

planned outage, for the purposes of Part 12, means an **outage** carried out in accordance with the planning requirements set out in the **Outage Protocol**

point of connection means—

- (a) a point at which **electricity** may flow, via one or more phases or conductors—
 - (i) into or out of a **network**; or
 - (ii) both into and out of a **network** at the same time, where each directional flow is on different phases or conductors; and
- (b) for the purposes of **Technical Code A** of Schedule 8.3, means a **grid injection point** or a **grid exit point**

Clause 1.1(1) **point of connection**: replaced, on 31 December 2021, by clause 4(11) of the Electricity Industry Participation Code Amendment (Code Review Programme) 2019.

point of measurement [*Revoked*]

Clause 1.1(1) **point of measurement**: revoked, on 29 August 2013, by clause 4(3) of the Electricity Industry Participation (Metering Arrangements) Code Amendment 2011.

point of service means a normally contiguous electrical busbar of a particular voltage at which **Transpower**, as a **grid owner**, has agreed to provide services to 1 or more **designated transmission customers**

point of supply, in relation to any premises, means the point at which fittings, used or intended to be used for the purposes of supplying **electricity** to those premises, enter those premises

policy statement means the policy statement that is incorporated by reference in this Code under clause 8.10

preceding year [*Revoked*]

Clause 1.1(1) **preceding year**: revoked, on 5 October 2017, by clause 4(60) of the Electricity Industry Participation Code Amendment (Code Review Programme) 2017.

preceding year day *[Revoked]*

Clause 1.1(1) **preceding year day**: revoked, on 5 October 2017, by clause 4(60) of the Electricity Industry Participation Code Amendment (Code Review Programme) 2017.

pre-dispatch schedule *[Revoked]*

Clause 1.1(1) **pre-dispatch schedule**: revoked, on 28 June 2012, by clause 4(i) of the Electricity Industry Participation (Demand-side Bidding and Forecasting) Code Amendment 2011.

preliminary sample means the statistical sample that is required in order to establish parameter estimates to determine the appropriate size of the **profile sample**

preliminary sample size means the required size of the **preliminary sample**

premium, in relation to an **options contract**, means the dollar amount paid by the **buyer** of the **options contract** to the **seller**

prescribed form means a form prescribed from time to time by the **Authority**

price, for the purposes of Part 5, includes—

- (a) valuable consideration in any form, whether direct or indirect; and
- (b) any consideration that in effect relates to the acquisition of goods or services or the acquisition or disposition of any interest in land, although ostensibly relating to any other matter or thing

price category means the relevant code in the schedule **published** by a **distributor** that is used to unambiguously define the line charges for an **ICP**

price-responsive schedule means the schedule prepared by the **system operator**—

- (a) under clause 13.58(1)(a); and
- (b) for the purpose of assisting **generators, purchasers, consumers, ancillary service agents, and grid owners** to manage their resources

Clause 1.1(1) **price-responsive schedule**: inserted, on 28 June 2012, by clause 4(a) of the Electricity Industry Participation (Demand-side Bidding and Forecasting) Code Amendment 2011.

pricing error means an error in an **interim price** or **interim reserve price** as a result of—

- (i) a **dispatch price** or **dispatch reserve price** that was not made available on **WITS** being used to calculate the **interim price** or **interim reserve price**; or
- (ii) the **clearing manager** having followed an incorrect process in calculating that **interim price** or **interim reserve price**, in contravention of this Code

Clause 1.1(1) **pricing error**: amended, on 1 November 2022, by clause 4(6)(e) of the Electricity Industry Participation Code Amendment (Real Time Pricing) 2022.

pricing manager *[Revoked]*

Clause 1.1(1) **pricing manager**: amended, on 20 December 2021, by clause 4(12) of the Electricity Industry Participation Code Amendment (Code Review Programme) 2019.

Clause 1.1(1) **pricing manager**: revoked, on 1 November 2022, by clause 4(2) of the Electricity Industry Participation Code Amendment (Real Time Pricing) 2022.

primary transmission equipment means any plant or equipment forming part of the **grid** that enables the bulk transfer of **electricity**, including without limitation transmission circuits, busbars and switchgear

principal performance obligation and **PPO** mean a **system operator** obligation set out in any of clauses 7.2A to 7.2D

Clause 1.1(1) **principal performance obligations** and **PPOs**: amended, on 19 May 2016, by clause 4(3) of the Electricity Industry Participation Code Amendment (System Operator and Alignment with Statutory Objective) 2016.

procurement plan means the procurement plan that is incorporated by reference in this Code under clause 8.42

profile means a fixed or variable **electricity consumption pattern** assigned to a particular group of **meter** registers or **unmetered loads**

profile acceptance limit means the maximum value allowed for the sample **co-efficient of variation** calculated from the **preliminary sample**

profile applicant means the **participant** who submitted an application to the **Authority** to approve a new **profile** or a change to an existing **profile**, and may be a joint entity with more than 1 **participant** or an independent commercial entity acting on behalf of 1 or more **participants**

Clause 1.1(1) **profile applicant**: amended, on 5 October 2017, by clause 4(46) of the Electricity Industry Participation Code Amendment (Code Review Programme) 2017.

profile class means the grouping of 1 or more individual **profiles** that are applied to **metering installations** and loads with similar generic descriptions

profile owner means the legal entity that introduced the approved **profile** or is nominated as the **profile owner** in accordance with Schedule 15.5

profile population means all **ICP identifiers** included in a **profile**

profile sample means the statistical sample used to generate consumption data that is to be used to represent the load patterns of all **ICP identifiers** included in the **profile**

profile sample size means the required size of the **profile sample**

provisional marginal location factor *[Revoked]*

Clause 1.1(1) **provisional marginal location factor**: revoked, on 1 November 2022, by clause 4(2) of the Electricity Industry Participation Code Amendment (Real Time Pricing) 2022.

provisional price *[Revoked]*

Clause 1.1(1) **provisional price**: revoked, on 1 November 2022, by clause 4(2) of the Electricity Industry Participation Code Amendment (Real Time Pricing) 2022.

provisional price situation *[Revoked]*

Clause 1.1(1) **provisional price situation**: revoked, on 1 November 2022, by clause 4(2) of the Electricity Industry Participation Code Amendment (Real Time Pricing) 2022.

provisional reserve price *[Revoked]*

Clause 1.1(1) **provisional reserve price**: revoked, on 1 November 2022, by clause 4(2) of the Electricity Industry Participation Code Amendment (Real Time Pricing) 2022.

public conservation period *[Revoked]*

Clause 1.1(1) **public conservation period**: inserted, on 1 April 2011, by clause 4(1) of the Electricity Industry Participation (Customer Compensation Schemes) Code Amendment 2011.

Clause 1.1(1) **public conservation period**: revoked, on 20 December 2021, by clause 4(13) of the Electricity Industry Participation Code Amendment (Code Review Programme) 2019.

publicise *[Revoked]*

Clause 1.1(1) **publicise**: revoked, on 5 October 2017, by clause 4(60) of the Electricity Industry Participation Code Amendment (Code Review Programme) 2017.

publish means—

- (a) in respect of information that the **Authority** is required to **publish** under this Code, to make the information available to the public, at no cost, on a website maintained by, or on behalf of, the **Authority**; or
- (b) in respect of information that a **participant** is required to **publish** under this Code, to make the information available to the public, at no cost, on a website maintained by, or on behalf of, the **participant**,—

and **published**, **publishes**, **publication**, and **publishing** have corresponding meanings

Clause 1.1(1) **publish**: replaced, on 5 October 2017, by clause 4(1)(f) of the Electricity Industry Participation Code Amendment (Code Review Programme) 2017.

purchaser means a person who buys **electricity** from the **clearing manager** and, for the purposes of Parts 8, 13, 14, and 14A, has the additional meaning set out in clause 1.5

Clause 1.1(1) **purchaser**: amended, on 5 October 2017, by clause 4(47) of the Electricity Industry Participation Code Amendment (Code Review Programme) 2017.

qualifying customer has the meaning set out in clause 9.21

Clause 1.1(1) **qualifying customer**: inserted, on 1 April 2011, by clause 4(1) of the Electricity Industry Participation (Customer Compensation Schemes) Code Amendment 2011.

qualifying date *[Revoked]*

Clause 1.1(1) **qualifying date**: inserted, on 1 April 2011, by clause 4(1) of the Electricity Industry Participation (Customer Compensation Schemes) Code Amendment 2011.

Clause 1.1(1) **qualifying date**: revoked, on 5 October 2017, by clause 4(60) of the Electricity Industry Participation Code Amendment (Code Review Programme) 2017.

quantity, for the purposes of subpart 5 of Part 13, means—

- (a) for a **contract for differences** or **options contract** the total volume in **MWh** of **electricity** to which the contract relates; or
- (b) for a **fixed-price physical supply contract**, the volume in **MWh** of **electricity** reasonably likely to be supplied under the contract

quarterly disclosure report means a report provided by a **major participant** under clause 13.2B.

Clause 1.1(1) **quarterly disclosure report**: inserted, on 1 April 2021, by clause 4(2) of the Electricity Industry Participation Code Amendment (Reporting on Wholesale Market Information Disclosure) 2020.

quote means an offer to buy or sell a **NZ electricity future** on an **exchange**

Clause 1.1(1) **quote**: inserted, on 3 February 2020, by clause 4 of the Electricity Industry Participation Code Amendment (Hedge Market Arrangements) 2020.

Clause 1.1(1) **quote**: revoked, on 3 November 2020 in accordance with section 40(2)(b) of the Electricity Industry Act 2010.

Clause 1.1(1) **quote**: inserted, on 27 April 2021, by clause 4(5) of the Electricity Industry Participation Code Amendment (Hedge Market Arrangements) 2021.

ratio compensation means a multiplier, used to convert **raw meter data** into **volume information**, that is developed from—

- (a) the connected ratio of **measuring transformers**; and
- (b) the number of **metering** elements; and
- (c) the resolution of the **meter**

Clause 1.1(1) **ratio compensation**: inserted, on 29 August 2013, by clause 4(1) of the Electricity Industry Participation (Metering Arrangements) Code Amendment 2011.

Clause 1.1(1) **ratio compensation**: amended, on 23 February 2015, by clause 75 of the Electricity Industry Participation Code Amendment (Distributed Generation) 2014.

Clause 1.1(1) **ratio compensation**: amended, on 5 October 2017, by clause 4(48) of the Electricity Industry Participation Code Amendment (Code Review Programme) 2017.

raw meter data means—

- (a) for the purposes of Part 10, information obtained by the **interrogation** of a **metering installation**; or
- (b) for the purposes of Part 15, information obtained from a **metering installation** by 1 of the following **interrogation** methods:
 - (i) locally by way of a handheld computer or recording device (in which case it must take the form of a downloaded file); or
 - (ii) locally by way of any other manual record (in which case it must take the form of the first entry in a database system); or
 - (iii) remotely (in which case it must take the form of database records), but excluding data transmission between **meters** and data concentrators that are relaying information into the **back office**

Clause 1.1(1) **raw meter data**: substituted, on 29 August 2013, by clause 4(2)(s) of the Electricity Industry Participation (Metering Arrangements) Code Amendment 2011.

reactive means that component of the impedance at which the current and voltage are 90 degrees out of phase

reactive capability means the **reactive power** injection or absorption capability of **generating units** and other **reactive power** resources such as Static Var Compensators, capacitors and synchronous condensers, and includes **reactive power** capability of a **generating unit** during the normal course of the **generating unit** operations

reactive current means the component of electrical current on a **line** 90 degrees out of phase with the voltage on the **line**

Clause 1.1(1) **reactive current**: inserted, on 24 November 2016, by clause 4 of the Electricity Industry Participation Code Amendment (Generation Fault Ride Through) 2016.

reactive energy means the integration over time of the product of voltage and current and the sine of the phase angle between them, normally measured in kilovar hours (kvarh)

Clause 1.1(1) **reactive energy**: inserted, on 29 August 2013, by clause 4(1) of the Electricity Industry Participation (Metering Arrangements) Code Amendment 2011.

reactive meter means a **meter** used for the measurement of **reactive power**

reactive power means the product of voltage and current and the sine of the phase angle between them, and which is normally measured in kiloVolt-Amps reactive (kVAr)

real time price *[Revoked]*

Clause 1.1(1) **real time price**: revoked, on 1 November 2022, by clause 4(2) of the Electricity Industry Participation Code Amendment (Real Time Pricing) 2022.

real time pricing period *[Revoked]*

Clause 1.1(1) **real time pricing period**: revoked, on 1 November 2022, by clause 4(2) of the Electricity Industry Participation Code Amendment (Real Time Pricing) 2022.

reasonable and prudent operating practice, in relation to **distributed generation**, includes—

- (a) the industry operating standards; and
- (b) measures to avoid the injection of **electricity** from **distributed generation** that—
 - (i) exceeds the **distribution network capacity** at the point of injection; or
 - (ii) results in a significant adverse effect on voltage levels; or
 - (iii) results in a significant adverse effect on the quality and reliability of **electricity** conveyed to other users of the **distribution network**; and
- (c) the use or proposed use of reasonable and prudent measures to enable the connection of **distributed generation**

Clause 1.1(1) **reasonable and prudent operating practice**: amended, on 23 February 2015, by clause 4(10) of the Electricity Industry Participation Code Amendment (Distributed Generation) 2014.

Clause 1.1(1) **reasonable and prudent operating practice**: amended, on 23 February 2015, by clause 75 of the Electricity Industry Participation Code Amendment (Distributed Generation) 2014.

Clause 1.1(1) **reasonable and prudent operating practice**: amended, on 5 October 2017, by clause 4(49) of the Electricity Industry Participation Code Amendment (Code Review Programme) 2017.

reasonable and prudent system operator [*Revoked*]

Clause 1.1(1) **reasonable and prudent system operator**: revoked, on 19 May 2016, by clause 4(1) of the Electricity Industry Participation Code Amendment (System Operator and Alignment with Statutory Objective) 2016.

recalibration means to repeat a **calibration** because a previous **calibration** has expired or become suspect, and **recalibrate** has a corresponding meaning

recertification means to repeat a **certification** because a previous **certification** has expired or been cancelled, and **recertified** and **recertify** have corresponding meanings

reconciled quantity means a quantity of **electricity** that has been reconciled by the **reconciliation manager**

reconciliation information means information specifying the amount of **electricity** sold to or purchased from the **clearing manager** in each **half hour** of a **reconciliation period** (or such other period as has been agreed to), calculated from and reconciled with **submission information** and the relevant **losses**, and after the process of balancing in accordance with clause 22 of Schedule 15.4

reconciliation manager means the **market operation service provider** for the time being appointed as reconciliation manager under this Code

Clause 1.1(1) **reconciliation manager**: amended, on 20 December 2021, by clause 4(14) of the Electricity Industry Participation Code Amendment (Code Review Programme) 2019.

reconciliation participant means a **participant** that—

- (a) is one of the following:
 - (i) a **retailer** when purchasing **electricity** from, or selling **electricity** to, the **clearing manager**;
 - (ii) a **generator**;
 - (iii) a **network** owner;
 - (iv) a **distributor**;
 - (v) a person who purchases **electricity** from or sells **electricity** to the **clearing manager**, including a **dispatchable load purchaser**; and
- (b) provides information to the **reconciliation manager** in accordance with

clauses 15.4 to 15.11

Clause 1.1(1) **reconciliation participant**: replaced, on 1 March 2024, by clause 4(16) of the Electricity Industry Participation Code Amendment (Code Review Programme) 2024.

reconciliation period means a calendar month, subsequent to a **consumption period**, during which the reconciliation process is performed in respect of the **electricity** conveyed during 1 or more **consumption periods**

Clause 1.1(1) **reconciliation period**: amended, on 1 June 2011, by clause 4(2) of the Electricity Industry Participation (Minor Amendments) Code Amendment 2011.

reconciliation type means a code that identifies the type of processing to be performed during reconciliation

reconfigured FTR means the portion of an **FTR** that was sold at an **FTR reconfiguration auction**

Clause 1.1(1) **reconfigured FTR**: inserted, on 1 November 2014, by clause 4(1) of the Electricity Industry Participation (FTR Reconfiguration Auctions) Code Amendment 2014.

recorded term means a term that is described in a **default distributor agreement template**, and may be included in a **default distributor agreement** in accordance with clause 3(2) of Schedule 12A.4

Clause 1.1(1) **recorded term**: inserted, on 20 July 2020, by clause 4(3) of the Electricity Industry Participation Code Amendment (Default Distributor Agreement) 2020.

reference point means,—

- (a) for the North Island,—
 - (i) the Haywards 220 kV bus to which the HVDC Pole 2 or Pole 3 **injection** or **oftake** is **electrically connected**; or
 - (ii) if there is no Pole 2 or Pole 3 **injection** or **oftake** that is **electrically connected** to a Haywards 220kV bus, the first indexed Haywards 220 kV **node**:
- (b) for the South Island,—
 - (i) the Benmore 220 kV bus to which the HVDC Pole 2 or Pole 3 **injection** or **oftake** is **electrically connected**; or
 - (ii) if there is no Pole 2 or Pole 3 **injection** or **oftake** that is **electrically connected** to a Benmore 220kV bus, the first indexed Benmore 220 kV **node**

Clause 1.1(1) **reference point**: substituted, on 1 July 2012, by clause 4(3) of the Electricity Industry Participation (HVDC Pole 3 Minor Amendments) Code Amendment 2012.

Clause 1.1(1) **reference point**: amended, on 23 February 2015, by clause 75 of the Electricity Industry Participation Code Amendment (Distributed Generation) 2014.

Clause 1.1(1) **reference point**: amended, on 5 October 2017, by clause 4(50) of the Electricity Industry Participation Code Amendment (Code Review Programme) 2017.

reference standard means a measuring instrument that has been **calibrated** by an **approved calibration laboratory** and is not used as a **working standard**

register means the register of **participants** maintained by the **Authority** under section 16 of the **Act**

registered, in relation to a **participant**, means that details of the **participant** are kept in the **register**

registry means the database maintained by the **Authority** to record information about **ICPs**

Clause 1.1(1) **registry** and **registry manager**: replaced, on 5 October 2017, by clause 4(1)(g) of the Electricity Industry Participation Code Amendment (Code Review Programme) 2017.

registry manager means the **market operation service provider** for the time being appointed as registry manager under this Code

Clause 1.1(1) **registry manager**: inserted, on 5 October 2017, by clause 4(61) of the Electricity Industry Participation Code Amendment (Code Review Programme) 2017.

registry metering records means the **metering records** set out in Table 1 of clause 7 of Schedule 11.4

Clause 1.1(1) **registry metering records**: inserted, on 29 August 2013, by clause 4(1) of the Electricity Industry Participation (Metering Arrangements) Code Amendment 2011.

regulated terms means the terms set out in Schedule 6.2

relative standard error means the error expressed as a percentage of the estimated parameter

relevant contracts *[Revoked]*

Clause 1.1(1) **relevant contracts**: revoked, on 24 March 2015, by clause 4(1)(r) of the Electricity Industry Participation (Settlement and Prudential Security) Code Amendment 2013.

relevant information *[Revoked]*

Clause 1.1(1) **relevant information**: amended, on 21 September 2012, by clause 4(7) of the Electricity Industry Participation (Minor Amendments) Code Amendment 2012.

Clause 1.1(1) **relevant information**: revoked, on 1 October 2013, by clause 4(3) of the Electricity Industry Participation (Disclosure Obligations) Code Amendment 2013.

relevant local reconciliation contracts means the contracts for the sale and/or the purchase of **electricity** within a **local network**

relevant participant *[Revoked]*

Clause 1.1(1) **relevant participant**: inserted, on 29 August 2013, by clause 4(1) of the Electricity Industry Participation (Metering Arrangements) Code Amendment 2011.

Clause 1.1(1) **relevant participant**: revoked, on 1 June 2017, by clause 4(2) of the Electricity Industry Participation Code Amendment (Requirements and Processes for Audits) 2016.

relevant registration factor *[Revoked]*

Clause 1.1(1) **relevant registration factor**: revoked, on 1 November 2022, by clause 4(2) of the Electricity Industry Participation Code Amendment (Real Time Pricing) 2022.

republish *[Revoked]*

Clause 1.1(1) **republish**: revoked, on 5 October 2017, by clause 4(60) of the Electricity Industry Participation Code Amendment (Code Review Programme) 2017.

reserve offer means the information that an **ancillary service agent** submits to the **system operator** under clauses 13.37 to 13.54 specifying the **instantaneous reserve** the **ancillary service agent** is willing and able to provide

Clause 1.1(1) **reserve offer**: substituted, on 28 June 2012, by clause 4(g) of the Electricity Industry Participation (Demand-side Bidding and Forecasting) Code Amendment 2011.

Clause 1.1(1) **reserve offer**: substituted, on 29 June 2017, by clause 5(b) of the Electricity Industry Participation Code Amendment (Shortened Gate Closure and Revised Bid and Offer Provisions) 2017.

residual loss and constraint excess means, in respect of a **billing period**, an amount available for the settlement of **FTRs** that is not required to settle **FTRs** for the **billing period**, but does not include any amount that is retained for the settlement of **FTRs** in a future **billing period** in accordance with clause 13.249(6)

Clause 1.1(1) **residual loss and constraint excess**: inserted, on 1 October 2011, by clause 4(1) of the Electricity Industry Participation (Financial Transmission Rights) Code Amendment 2011.

Clause 1.1(1) **residual loss and constraint excess**: amended, on 24 March 2015, by clause 4(1)(s) of the Electricity Industry Participation (Settlement and Prudential Security) Code Amendment 2013.

resistive means that component of the impedance that is where the current and voltage are in phase

responsible party means the person responsible for the installation, maintenance, operation and **interrogation** of a **metering installation** and the supply of **submission information** to the **reconciliation manager**

retailer means as follows:

- (a) except as provided in paragraphs (b) and (c), a **participant** who supplies **electricity** to another person for any purpose other than for resupply by the other person:
- (b) in Parts 1 (except for the definition of specified participant), 8, 10, and 12 to 15, a **participant** who supplies **electricity** to a **consumer** or to another **retailer**:
- (c) in subpart 4 of Part 9, the **retailer** defined in paragraph (a) who is recorded in the **registry** as being responsible for the **ICP** described in clause 9.21(1)(b)

Clause 1.1(1) **retailer**: substituted, on 1 April 2011, by clause 4(2) of the Electricity Industry Participation (Customer Compensation Schemes) Code Amendment 2011.

Clause 1.1(1) **retailer** para (b): amended, on 28 February 2015, by clause 4 of the Electricity Industry Participation Code Amendment (Trader Default) 2014.

Clause 1.1(1) **retailer**: amended, on 5 October 2017, by clause 4(51) of the Electricity Industry Participation Code Amendment (Code Review Programme) 2017.

retail gross margin report means a report provided by a **retailer** under clause 13.259

Clause 1.1(1) **retail gross margin report**: inserted, on 30 November 2021, by clause 4 of the Electricity Industry Participation Code Amendment (Internal Transfer Prices and Segmented Profitability Reporting) 2021.

retail ITP means the notional price or prices per **MWh** for **electricity** set between either the generating arm or the trading arm of a **generator retailer**, on the one hand, and the retailing arm of the **generator retailer**, on the other hand, in respect of **electricity** generated by the **generator retailer** that is sold by the **generator retailer** to **mass market customers** and that is used for internal accounting, management, or other purposes

Clause 1.1(1) **retail ITP**: inserted, on 30 November 2021, by clause 4 of the Electricity Industry Participation Code Amendment (Internal Transfer Prices and Segmented Profitability Reporting) 2021.

Rio Tinto agreement *[Revoked]*

Clause 1.1(1) **Rio Tinto agreement**: revoked, on 16 December 2013, by clause 4(2)(c) of the Electricity Industry Participation (Revocation of Part 16) Code Amendment 2013.

Rio Tinto party *[Revoked]*

Clause 1.1(1) **Rio Tinto party**: revoked, on 16 December 2013, by clause 4(2)(d) of the Electricity Industry Participation (Revocation of Part 16) Code Amendment 2013.

risk management contract, for the purposes of subpart 5 and subpart 7 of Part 13, means—

- (a) a **contract for differences**; or
- (b) a **fixed-price physical supply contract**; or
- (c) an **options contract**; but
- (d) does not include an **FTR**

Clause 1.1(1) **risk management contract**: amended, on 15 May 2014, by clause 4(5) of the Electricity Industry Participation (Minor Code Amendments) Code Amendment 2014.

Clause 1.1(1) **risk management contract**: amended, on 19 August 2022, by clause 4(5) of the Electricity Industry Participation Code Amendment (Restrictions on Materially Large Contracts) 2022.

Clause 1.1(1) **risk management contract**: revoked, on 18 May 2023, by clause 2(2) of the Electricity Industry Participation Code Amendment (Restrictions on Materially Large Contracts) 2023.

Clause 1.1(1) **risk management contract**: inserted, on 19 May 2023, by clause 4(5) of the Electricity Industry Participation Code Amendment (Restrictions on Materially Large Contracts) 2023.

round power means a mode of operation of the **HVDC link** where power is transferred in opposite directions on Pole 2 and Pole 3

Clause 1.1(1) **round power**: inserted, on 1 July 2012, by clause 4(4) of the Electricity Industry Participation (HVDC Pole 3 Minor Amendments) Code Amendment 2012.

rules means the Electricity Governance Rules 2003

Rulings Panel has the meaning given to it in section 5 of the Act

sample date means the most recent date when the **profile sample** was drawn or updated

satisfactory state means that none of the following occur on the power system:

- (a) insufficient **supply of electricity** to satisfy **demand for electricity** at any **grid exit point**;
- (b) **unacceptable overloading** of any **primary transmission equipment**;
- (c) **unacceptable voltage conditions**;
- (d) **system instability**

SCADA means the monitoring and remote control of equipment from a central location using computing technologies

SCADA situation [*Revoked*]

Clause 1.1(1) **SCADA situation**: amended, on 15 May 2014, by clause 5(7) of the Electricity Industry Participation (Modified Dispatchable Demand) Code Amendment 2013.

Clause 1.1(1) **SCADA situation**: revoked, on 1 November 2022, by clause 4(2) of the Electricity Industry Participation Code Amendment (Real Time Pricing) 2022.

scaling factor, for the purpose of Appendix A of Technical Code C of Schedule 8.3, means a factor applied to a measurement at 1 point to calculate a corresponding measurement at another point

Clause 1.1(1) **scaling factor**: inserted, on 1 June 2011, by clause 4(1) of the Electricity Industry Participation (Minor Amendments) Code Amendment 2011.

schedule of dispatch prices, dispatch quantities, dispatch arc flows, dispatch group constraint arc flows, group constraint formulas and HVDC component flows

[*Revoked*]

Clause 1.1(1) **schedule of dispatch prices, dispatch quantities, dispatch arc flows, dispatch group constraint arc flows, group constraint formulas and HVDC component flows**: revoked, on 28 June 2012, by clause 4(i) of the Electricity Industry Participation (Demand-side Bidding and Forecasting) Code Amendment 2011.

scarcity pricing situation [*Revoked*]

Clause 1.1(1) **scarcity pricing situation**: inserted, on 1 June 2013, by clause 4(a) of the Electricity Industry Participation (Scarcity Pricing) Code Amendment 2011.

Clause 1.1(1) **scarcity pricing situation**: revoked, on 1 November 2022, by clause 4(2) of the Electricity Industry Participation Code Amendment (Real Time Pricing) 2022.

schedule length period means,—

- (a) in relation to a **price-responsive schedule** or a **non-response schedule** prepared under clause 13.62(1)(a), the current **trading period** and the following 71 **trading periods**; and

- (b) in relation to a **price-responsive schedule** or a **non-response schedule** prepared under clause 13.62(1)(b), the current **trading period** and the following **7 trading periods**

Clause 1.1(1) **schedule length period**: inserted, on 28 June 2012, by clause 4(a) of the Electricity Industry Participation (Demand-side Bidding and Forecasting) Code Amendment 2011.

schedule period means the current **trading period** and the following **71 trading periods**

Clause 1.1(1) **schedule period**: substituted, on 28 June 2012, by clause 4(h) of the Electricity Industry Participation (Demand-side Bidding and Forecasting) Code Amendment 2011.

scheduled quantity, for the purposes of clauses 13.194 and 13.204(1)(a) and (b), means the sum of all the **offer** quantities at the relevant **grid injection point** at which the **final price** is equal to or greater than the **offer** price for each of those **offer** quantities in the relevant **trading period**. For the **grid injection points** that form part of a **block dispatch group**, **scheduled quantity** is the sum of all the **offer** quantities of the individual **grid injection points** that form that **block dispatch group** at which the **final price** is equal to or greater than the **offer** price for each of those **offer** quantities in the relevant **trading period**

scorecard rating means the numerical value, pursuant to clauses 17 and 18 of Schedule 15.4, to rate the quality of each **retailer's** processes for the production of **submission information**

seasonal adjustment shape means the total energy consumption (expressed as daily kWh values) for all **NSP** derived **profiles** for all **retailers** in each **balancing area**

secure state means that the power system—

- (a) would be in a **satisfactory state**; and
- (b) would remain in a **satisfactory state** during and following a **single credible contingency event** occurring on the **grid**

security of supply forecasting and information policy means the security of supply forecasting and information policy that is incorporated by reference in this Code under clause 7.4

selected component certification means **certification** of a **metering installation** under clause 11(3) of Schedule 10.7

Clause 1.1(1) **selected component certification**: inserted, on 29 August 2013, by clause 4(1) of the Electricity Industry Participation (Metering Arrangements) Code Amendment 2011.

seller, for the purposes of subpart 5 and subpart 7 of Part 13, means—

- (a) in respect of a **contract for differences**, the **floating-price payer**; or
- (b) in respect of a **fixed-price physical supply contract**, the **party** selling the **electricity**; or
- (c) in respect of an **options contract**, either—
 - (i) the **party** receiving the **premium**; or
 - (ii) if there is no **premium** under the **options contract**, the **party** who agrees to be the **seller** for the purposes of subpart 5 or subpart 7 (as applicable) of Part 13; or
 - (iii) if neither **party** agrees to be the **seller**, the **party** whose name is the second alphabetically
- (d) for the purposes of subpart 7 of Part 13, in respect of any other contract, the **party** who is not the **buyer**

Clause 1.1(1) **seller**: amended, on 19 August 2022, by clause 4(6) of the Electricity Industry Participation Code Amendment (Restrictions on Materially Large Contracts) 2022.

Clause 1.1(1) **seller**: revoked, on 18 May 2023, by clause 2(2) of the Electricity Industry Participation Code Amendment (Restrictions on Materially Large Contracts) 2023.

Clause 1.1(1) **seller**: inserted, on 19 May 2023, by clause 4(6) of the Electricity Industry Participation Code Amendment (Restrictions on Materially Large Contracts) 2023.

series, for the purposes of determining the level of impedance of **branches** under Part 12, means an arrangement of **assets** where the **assets** comprising a **branch** have the same current flowing through them

serious financial breach means a failure by a **retailer**—

- (a) to pay to a **distributor** an amount due and owing that exceeds the greater of \$100,000 or 20% of the actual charges payable by the **retailer** for the previous month, unless the amount is genuinely disputed by the **retailer**; or
- (b) to pay to a **distributor** 100% of the actual charges payable by the **retailer** for the previous two months, unless the amount is genuinely disputed by the **retailer**; or
- (c) to comply with the prudential requirements under a **distributor agreement** between the **retailer** and a **distributor**.

Clause 1.1(1) **serious financial breach**: inserted, on 16 December 2013, by clause 4 of the Electricity Industry Participation (Managing Retailer Default Situations) Code Amendment 2013.

Clause 1.1(1) **serious financial breach**: replaced, on 20 July 2020, by clause 4(1) of the Electricity Industry Participation Code Amendment (Default Distributor Agreement) 2020.

services access interface means the point, at which access may be gained to the services available from a **metering installation**, that is—

- (a) recorded in the **certification report** by the **certifying ATH** for the **metering installation**; and
- (b) where information received from the **metering installation** can be made available to another person; and
- (c) where signals for services such as remote control of load (but not ripple control) can be injected

Clause 1.1(1) **services access interface**: inserted, on 29 August 2013, by clause 4(1) of the Electricity Industry Participation (Metering Arrangements) Code Amendment 2013.

settlement default means failure of a **participant** to pay any amount payable when it becomes due under Part 14

Clause 1.1(1) **settlement default**: inserted, on 24 March 2015, by clause 4(1)(t) of the Electricity Industry Participation (Settlement and Prudential Security) Code Amendment 2013.

settlement residue is the **loss and constraint excess** and **residual loss and constraint excess** paid to a **grid owner** by the **clearing manager** under Part 14.

Clause 1.1(1) **settlement residue**: inserted, on 1 April 2023, by clause 4 of the Electricity Industry Participation Code Amendment (Settlement Residual Allocation Methodology) 2022.

shared unmetered load means **unmetered load** at a single **point of connection** that is distributed across more than 1 **ICP**, including without limitation, streetlighting in a private right-of-way servicing multiple properties, and sewage pumps servicing multiple properties

Clause 1.1(1) **shared unmetered load**: amended, on 1 March 2024, by clause 4(17) of the Electricity Industry Participation Code Amendment (Code Review Programme) 2024.

shortage situation [*Revoked*]

Clause 1.1(1) **shortage situation**: inserted, on 1 June 2013, by clause 4(a) of the Electricity Industry Participation

(Scarcity Pricing) Code Amendment 2011.

Clause 1.1(1) **shortage situation**: revoked, on 1 November 2022, by clause 4(2) of the Electricity Industry Participation Code Amendment (Real Time Pricing) 2022.

shunt, for the purposes of determining the level of impedance of **branches** under Part 12, means an arrangement of **assets** where the **assets** comprising a **branch** have the same voltage across the terminals

shunt asset, for the purposes of Part 12, means a shunt connected **asset** that is an **interconnection asset**

Clause 1.1(1) **shunt asset**: amended, on 23 February 2015, by clause 75 of the Electricity Industry Participation Code Amendment (Distributed Generation) 2014.

Clause 1.1(1) **shunt asset**: amended, on 5 October 2017, by clause 4(52) of the Electricity Industry Participation Code Amendment (Code Review Programme) 2017.

simple random sampling without replacement means the general procedure of drawing **consumers** from a **profile population** to form a sample. Each **consumer** in the **profile population** must have an equal probability of being drawn and may only be drawn once

single credible contingency event means an individual credible contingency event comprising any of the following:

- (a) a single transmission circuit interruption:
- (b) the failure or removal from operational service of a single **generating unit**:
- (c) an **HVDC link** single pole interruption:
- (d) the failure or removal from service of a single bus section:
- (e) a single inter-connecting transformer interruption:
- (f) the failure or removal from service of a single shunt connected reactive component

Clause 1.1(1) **single credible contingency event**: amended, on 23 February 2015, by clause 75 of the Electricity Industry Participation Code Amendment (Distributed Generation) 2014.

Clause 1.1(1) **single credible contingency event**: amended, on 5 October 2017, by clause 4(53) of the Electricity Industry Participation Code Amendment (Code Review Programme) 2017.

single-line diagram means a schematic diagram of a **network** interface

software means, other than in Parts 10 and 15, any software—

- (a) developed by or on behalf of a **market operation service provider** that is used by that **market operation service provider** to perform its obligations under this Code or its **market operation service provider agreement**; or
- (b) used by a **market operation service provider** exclusively for the purposes of performing its obligations under this Code or its **market operation service provider agreement**

Clause 1.1(1) **software**: amended, on 29 August 2013, by clause 4(2)(t) of the Electricity Industry Participation (Metering Arrangements) Code Amendment 2011.

software specification means the user requirements and other information describing the **software** in respect of the **market operation service providers**

special credit clause means a clause in a **contract for differences** that specifies that, if a **party** defaults during the **term** of the contract, the **party** that is not in default will be paid a specified amount or that on execution of the contract, the **party** that is not in

default, is provided with a guarantee that payment will be made when the settlement amount reaches a certain threshold

special protection scheme means a protection scheme that takes predetermined action, including reconfiguration of the **grid**, changes of **demand**, or changes of generation, to counteract a particular condition once that condition is detected. **Special protection schemes** allow a power system to be operated to a higher pre-event capacity limit while still in a **secure state**. **Automatic under-frequency load shedding** systems and **instantaneous reserves** are excluded from the requirements for **special protection schemes**

Clause 1.1(1) **special protection scheme**: inserted, on 1 June 2011, by clause 4(1) of the Electricity Industry Participation (Minor Amendments) Code Amendment 2011.

Clause 1.1(1) **special protection scheme**: amended, on 15 May 2014, by clause 4(6) of the Electricity Industry Participation (Minor Code Amendments) Code Amendment 2014.

Clause 1.1(1) **special protection scheme**: amended, on 1 February 2016, by clause 4(15) of the Electricity Industry Participation Code Amendment (Code Review Programme) 2015.

specified participant for the purposes of Part 9,—

- (a) means any of the following:
 - (i) **distributor**;
 - (ii) **retailer**;
 - (iii) a **line owner**; and
- (c) includes a person who uses **electricity** that is conveyed to the person directly from the **grid**

specified person has the meaning given in section 32(6) of the **Act**

Clause 1.1(1) **specified person**: inserted, on 31 August 2023, by clause 4 of the Electricity Industry Participation Code Amendment (Part 6A Dispensation for Specified Persons) 2023.

Clause 1.1(1) **specified person**: replaced, on 1 March 2024, by clause 4 of the Electricity Industry Participation Code Amendment (Part 6A Dispensation for Specified Persons) 2024.

spot price risk disclosure statement means a spot price risk disclosure statement prepared and submitted under clause 13.236A

Clause 1.1(1) **spot price risk disclosure statement**: inserted, on 1 December 2011, by clause 4 of the Electricity Industry Participation Code (Spot Price Risk Disclosure) Amendment 2011.

statement of extended reserve obligation [*Revoked*]

Clause 1.1(1) **statement of extended reserve obligations**: inserted, on 7 August 2014, by clause 4(3) of the Electricity Industry Participation Code Amendment (Extended Reserve) 2014.

Clause 1.1(1) **statement of extended reserve obligation**: revoked, on 21 December 2021, by clause 4(3) of the Electricity Industry Participation Code Amendment (Automatic Under-Frequency Load Shedding Systems) 2021.

statement of proposal, in relation to a proposal, means a statement that contains—

- (a) a detailed statement of the proposal; and
- (b) a statement of the reasons for the proposal; and
- (c) an assessment of the reasonably practicable options, including the proposal; and
- (d) any other information relevant to considering the proposal.

station dispatch group means—

- (a) 1 or more **generating units** that inject into a single **grid injection point**; or
- (b) 1 or more **generating units** that are the subject of an agreement between the **system operator** and a **generator**,—

and is not a **block dispatch group**

station net means the sum of all **generating unit net** outputs for **generating units** at a single **generating station**, measured or calculated at its **point of connection**, but excludes **generating unit load** and any other active or **reactive power** (including **losses**) supplied between the **generating station** and the **point of connection**

Clause 1.1(1) **station net**: inserted, on 1 June 2011, by clause 4(1) of the Electricity Industry Participation (Minor Amendments) Code Amendment 2011.

Clause 1.1(1) **station net**: amended, on 20 December 2021, by clause 4(15) of the Electricity Industry Participation Code Amendment (Code Review Programme) 2019.

station security constraint means any of the following:

- (a) a security constraint as determined in accordance with the **policy statement** and applied by the **system operator** to a **generating unit** to provide **voltage support** or **frequency keeping**;
- (b) a limitation in **grid** capacity that:
 - (i) is a limitation in the capacity of the **grid** to convey **electricity** between either—
 - (A) **generating units** constituting a **station dispatch group**; or
 - (B) **generating units** constituting a **station dispatch group** and the **grid**;and
 - (ii) arises because of either—
 - (A) a limitation in the offered capacity of the **grid**; or
 - (B) a security constraint as determined by the **system operator** in accordance with the **policy statement**

Clause 1.1(1) **station security constraint**: replaced, on 31 December 2021, by clause 4(16) of the Electricity Industry Participation Code Amendment (Code Review Programme) 2019.

stress test means a stress test **published** by the **Authority** under clause 13.236D

Clause 1.1(1) **stress test**: inserted, on 1 December 2011, by clause 4 of the Electricity Industry Participation Code (Spot Price Risk Disclosure) Amendment 2011.

Clause 1.1(1) **stress test**: amended, on 5 October 2017, by clause 4(54) of the Electricity Industry Participation Code Amendment (Code Review Programme) 2017.

sub-block dispatch groups means a grouping of **generating stations** or **generating units** within a **block dispatch group** into subgroups to take account of any **block security constraints** of which the **system operator** gives notice in accordance with clauses 13.61(1) and 13.73(1)(j)

Clause 1.1(1) **sub-block dispatch groups**: amended, on 21 September 2012, by clause 4(8) of the Electricity Industry Participation (Minor Amendments) Code Amendment 2012.

Clause 1.1(1) **sub-block dispatch groups**: amended, on 15 May 2014, by clause 5(8) of the Electricity Industry Participation (Modified Dispatchable Demand) Code Amendment 2013.

Clause 1.1(1) **sub-block dispatch groups**: amended, on 1 November 2018, by clause 4(8)(a) and (b) of the Electricity Industry Participation Code Amendment (Code Review Programme) 2018.

sub-station dispatch group means a grouping of **generating units** or **generating stations** within a **station dispatch group** into subgroups to take account of any **station security constraints** of which the **system operator** gives notice in accordance with clauses 13.65(1) and 13.75(1)(g)

Clause 1.1(1) **sub-station dispatch groups**: amended, on 15 May 2014, by clause 5(9) of the Electricity Industry Participation (Modified Dispatchable Demand) Code Amendment 2013.

Clause 1.1(1) **sub-station dispatch groups**: amended, on 1 February 2016, by clause 4(16) of the Electricity Industry Participation Code Amendment (Code Review Programme) 2015.

Clause 1.1(1) **sub-station dispatch group**: amended, on 1 November 2018, by clause 4(9) of the Electricity Industry Participation Code Amendment (Code Review Programme) 2018.

submission expiry date means—

- (a) *[Revoked]*
- (b) *[Revoked]*
- (c) *[Revoked]*
- (d) *[Revoked]*
- (e) in the case of a submission on the draft **grid reliability standards**, the date **published** by the **Authority** in accordance with clause 12.61(3); and
- (f) in the case of a submission on the issues paper, the date **published** by the **Authority** in accordance with clause 12.82(1); and
- (g) in the case of a submission on the proposed **transmission pricing methodology**, the date **published** by the **Authority** in accordance with clause 12.92(2)

Clause 1.1(1) **submission expiry date**: amended, on 19 December 2014, by clause 4(4) of the Electricity Industry Participation Code Amendment (Minor Code Amendments) (No 3) 2014.

Clause 1.1(1) **submission expiry date**: amended, on 1 November 2018, by clause 4(10)(a) and (b) of the Electricity Industry Participation Code Amendment (Code Review Programme) 2018.

Clause 1.1(1) **submission expiry date**: paragraphs (a) and (b) revoked, on 1 August 2023, by clause 4(4) of the Electricity Industry Participation Code Amendment (System Operation Documents) 2023.

Clause 1.1(1) **submission expiry date**: paragraphs (c) and (d) revoked, on 1 October 2023, by clause 4(4) of the Electricity Industry Participation Code Amendment (Default Transmission Agreement) 2023.

submission information means **volume information** aggregated in accordance with clause 8 of Schedule 15.3 (and includes, if relevant, any **profile** shape or control times associated with a **profile**)

subsidiary means a subsidiary as defined in section 5 of the Companies Act 1993

supply means a measure of the rate of production of electrical energy

supply shortage declaration means a declaration made under clause 9.14

suspension clause means a clause in a **risk management contract** under which some or all of the obligations may be suspended due to an event directly relating to the **supply** (including transmission) or generation of **electricity** or the price at which **electricity** is supplied, including an inability to inject **electricity** into the **grid** as a result of an **outage** of or damage to the **grid** or a **grid injection point** or the price of **electricity** exceeding a level specified in the contract

sustained instantaneous reserve means the average increase in generation or reduction in **demand** (in MW) provided by **instantaneous reserve** during the first 60 seconds after the start of a “Contingent Event” (as defined in the **policy statement**) and that is sustained for at least 15 minutes after the start of the “Contingent Event” (unless a new **dispatch instruction** is given before the expiry of that 15 minute period)

Clause 1.1(1) **sustained instantaneous reserve**: amended, on 3 May 2022, by clause 4(3)(e) of the Electricity Industry Participation Code Amendment (Enabling Energy Storage Systems to Offer Instantaneous Reserve) 2022.

switch means the process of a customer of a **losing retailer** changing from receiving the supply of **electricity** from the **losing retailer** to receiving the supply of **electricity** from a **gaining retailer**, and the term **switching** has a corresponding meaning

Clause 1.1(1) **switch**: inserted, on 31 March 2020, by clause 4 of the Electricity Industry Participation Code Amendment (Prohibition of Save and Win-Back Approaches by Losing Retailers During a Switch Protected Period) 2020.

switch event meter reading, in relation to a **meter** or **data storage device** that is located at an **ICP** that is being switched under Schedule 11.3, means—

- (a) a **validated meter reading**, if one is available; or
- (b) a reasonable estimate of the **meter reading** based on the **meter reading** contained in the final information provided in the switch file that the losing **trader** received when it gained the **ICP** if—
 - (i) a **validated meter reading** is not available; and
 - (ii) the losing **trader** has been recorded in the **registry** as being responsible for the **ICP** for a period of less than 3 months; or
- (c) in every other case, a **permanent estimate**

Clause 1.1(1) **switch event meter reading**: amended, on 9 October 2015, by clause 4 of the Electricity Industry Participation Code Amendment (ICP Switching) 2014.

switch protected period means the period that:

- (a) starts on the earlier of—
 - (i) the day on which the **registry manager**, under clause 22(a) of Schedule 11.3, makes written notice available to the **losing retailer** or the **losing retailer** otherwise becomes aware that a customer is switching to a **gaining retailer**; or
 - (ii) the day on which a **gaining retailer** assumes responsibility for billing a customer of a **losing retailer** for **electricity**; and
- (b) ends on the earlier of—
 - (i) the date that is 180 days after the relevant date specified in paragraph (a); or
 - (ii) the date on which the **losing retailer** receives a notice under clause 4A(1) of Schedule 11.5 from the **Authority** or otherwise becomes aware that the customer is switching from the **gaining retailer** back to the **losing retailer** due to an **event of default**; or
 - (iii) if the **gaining retailer** is a **trader** and makes a withdrawal request, the date on which the **registry manager**, under clause 22(b) of Schedule 11.3, makes written notice of the withdrawal request available to the **losing retailer** (if a **trader**); or
 - (iv) if the **trader** for the **losing retailer** and **gaining retailer** (neither of whom is a **trader**) is the same, the date on which the **trader** receives advice from the **gaining retailer** withdrawing the switch request from the **losing retailer**.

Clause 1.1(1) **switch protected period**: inserted, on 31 March 2020, by clause 4 of the Electricity Industry Participation Code Amendment (Prohibition of Save and Win-Back Approaches by Losing Retailers During a Switch Protected Period) 2020.

Clause 1.1(1) **switch protected period**: amended, on 1 March 2022, by clause 17(a) and (b) of the Electricity Industry Participation Code Amendment (Code Review Programme) 2019.

synchronised means the condition whereby a synchronous **generating unit** is **electrically connected** to a **network** and the electrical angular velocity of the **generating unit** corresponds with the **network** frequency and **synchronise**, **de-synchronise**, **synchronising**, **synchronism** and **synchronisation** have corresponding meanings. Asynchronous **intermittent generating stations** must be treated as being **synchronised** for the purposes of subpart 2 of Part 8

Clause 1.1(1) **synchronised**: amended, on 23 February 2015, by clause 75 of the Electricity Industry Participation Code Amendment (Distributed Generation) 2014.

Clause 1.1(1) **synchronised**: amended, on 5 October 2017, by clause 4(55) of the Electricity Industry Participation Code Amendment (Code Review Programme) 2017.

Clause 1.1(1) **synchronised**: amended, on 20 March 2020, by clause 4(4) of the Electricity Industry Participation Code Amendment (Broadening Definitions of Generating Unit and Intermittent Generating Station) 2020.

system instability means operating conditions under which it is reasonably likely that 1 or more **generating units** may cease to be **synchronised** with the **grid**

system number means a coded number assigned to **assets** referred to in clause 2(1)(a) of **Technical Code A** of Schedule 8.3 for the purposes of the operation of the **grid** and the management of the **assets** that, when used in conjunction with a locality name, uniquely identifies the **assets**

System operation document means any of the following documents:

- (a) the **security of supply forecasting and information policy**;
- (b) the **emergency management policy**;
- (c) the **policy statement**;
- (d) the **procurement plan**;
- (e) the **AUFLS technical requirements report**;
- (f) the **system operator rolling outage plan**.

Clause 1.1(1) **system operation document**: inserted, on 1 August 2023, by clause 4(1) of the Electricity Industry Participation Code Amendment (System Operation Documents) 2023.

system operator has the meaning given to it in section 5 of the **Act**

system operator register means the register kept by the **system operator** for recording **equivalence arrangements, dispensations, and alternative ancillary service arrangements** in accordance with clause 8 of Schedule 8.1 and clause 4 of Schedule 8.2.

Clause 1.1(1) **system operator register**: amended, on 5 October 2017, by clause 4(56) of the Electricity Industry Participation Code Amendment (Code Review Programme) 2017.

Clause 1.1(1) **system operator register**: amended, on 20 December 2021, by clause 4(18) of the Electricity Industry Participation Code Amendment (Code Review Programme) 2019.

system operator rolling outage plan means the system operating rolling outage plan that is incorporated by reference in this Code under clause 9.3

system security means the security and quality objectives set out in Part 8

system security forecast means the forecast prepared by the **system operator** under clause 8.15

system security situation means any situation that the **system operator** believes on reasonable grounds is not adequately mitigated by the current **policy statement** and 1 of the following exists:

- (a) the **system operator** reasonably considers that its ability to comply with the **principal performance obligations** is at risk;
- (b) there is a risk of significant damage to **assets**;
- (c) public safety is at risk

system test means a test conducted on an **asset**, with the **asset electrically connected to the grid**, to assess the interaction of the **asset** with the **grid**

Clause 1.1(1) **system test**: amended, on 23 February 2015, by clause 75 of the Electricity Industry Participation Code Amendment (Distributed Generation) 2014.

Clause 1.1(1) **system test**: amended, on 5 October 2017, by clause 4(57) of the Electricity Industry Participation Code Amendment (Code Review Programme) 2017.

tail water depressed reserve means a form of **generation reserve** comprising a generating capacity on a motoring hydro generation set with no water flowing through the turbine that is available following a drop in system frequency

Clause 1.1(1) **tail water depressed reserve**: amended, on 3 May 2022, by clause 4(4) of the Electricity Industry Participation Code Amendment (Enabling Energy Storage Systems to Offer Instantaneous Reserve) 2022.

technical codes means the technical codes contained in Schedule 8.3

temporary energisation *[Revoked]*

Clause 1.1(1) **temporary energisation**: inserted, on 29 August 2013, by clause 4(1) of the Electricity Industry Participation (Metering Arrangements) Code Amendment 2011.

Clause 1.1(1) **temporary energisation**: revoked, on 5 October 2017, by clause 4(60) of the Electricity Industry Participation Code Amendment (Code Review Programme) 2017.

term, for the purposes of subpart 5 of Part 13, means the term of a **risk management contract**, being the period between the **effective date** and the **end date**

test facility means a device that permits access to voltage and current circuits for testing purposes while the **metering installation** is in normal service

time block means a block of **trading periods** either from 1 to 16 (inclusive) or from 17 to 48 (inclusive) in each **trading day**. On the day on which **New Zealand daylight time** begins **time block** means a block of **trading periods** either from 1 to 14 (inclusive) or from 15 to 46 (inclusive). On the day on which **New Zealand daylight time** ends, **time block** means a block of **trading periods** either from 1 to 18 (inclusive) or from 19 to 50 (inclusive)

time block meter channel means a **meter** channel where—

- (a) the volume of **electricity** conveyed is recorded on two or more **meter** registers; and
- (b) each **meter** register is active for a fixed period of time; and
- (c) only one **meter** register is active at any point in time.

Clause 1.1(1) **time block meter channel**: inserted, on 1 February 2021, by clause 4(2) of the Electricity Industry Participation Code Amendment (Metering and Related Registry Processes) 2020.

total auction revenue means, for each **auction**, the aggregate of all amounts owing by all **generators** in the relevant **time block**

Clause 1.1(1) **total auction revenue**: amended, on 24 March 2015, by clause 4(1)(u) of the Electricity Industry Participation (Settlement and Prudential Security) Code Amendment 2013.

total required volume, for the purposes of subpart 5B of Part 13, means 2.4 MW base load equivalent of **NZ electricity futures**, taking into account traded **NZ electricity futures** across both buy **quotes** and sell **quotes**

Clause 1.1(1) **total required volume**: inserted, on 1 September 2022, by clause 4(2) of the Electricity Industry Participation Code Amendment (Hedge Market Arrangements) 2022.

total traded NZEF, for the purposes of subpart 5B of Part 13, means the cumulative total amount of buy **quotes** and sell **quotes** traded by that **participant** as **NZ electricity futures** up to the start of the current **volume refresh period** in that **NZEF market-making period** in relation to the applicable reference **node** (Benmore or Otahuhu) and for the particular month or calendar quarter referred to in clause 13.236L(1) for the **participant** to which the **total traded NZEF** is being applied

Clause 1.1(1) **total traded NZEF**: inserted, on 1 September 2022, by clause 4(2) of the Electricity Industry Participation Code Amendment (Hedge Market Arrangements) 2022.

traceable means having the property of **traceability**

traceability is the property of the result of a measurement whereby it can be related to the SI units of measurement through an unbroken chain of comparisons, each with a stated **uncertainty**

trade date, for the purposes of subpart 5 of Part 13, means the date on which legally binding rights and obligations are created between the **parties** to a **risk management contract**

trader means a **retailer** or a **generator** or a **purchaser** who—

- (a) buys **electricity** from the **clearing manager**; or
- (b) sells **electricity** to the **clearing manager**; or
- (c) enters into an arrangement with another **retailer** or **generator** or **purchaser** to buy or sell contracts (or parts of contracts) for **electricity** for the purposes of this Code

Clause 1.1(1) **trader**: amended, on 29 August 2013, by clause 4(2)(u) of the Electricity Industry Participation (Metering Arrangements) Code Amendment 2011.

trading day means the period from 0000 hours until 2400 hours on any day

trading period means a period of 30 minutes ending on each hour or 30 minutes past each hour on any **trading day**

trading rights means, in relation to a **generator** or a **purchaser**, the rights conferred on the **generator** or **purchaser** by this Code in relation to the trading of **electricity**

transfer [*Revoked*]

Clause 1.1(1) **transfer**: revoked, on 20 December 2021, by clause 4(19) of the Electricity Industry Participation Code Amendment (Code Review Programme) 2019.

transformer branch means a **branch** that contains a transformer

transmission alternative [*Revoked*]

Clause 1.1(1) **transmission alternative**: amended, on 21 September 2012, by clause 4(9) of the Electricity Industry Participation (Minor Amendments) Code Amendment 2012.

Clause 1.1(1) **transmission alternative**: revoked, on 15 May 2014, by clause 4(7)(a) of the Electricity Industry Participation (Minor Code Amendments) Code Amendment 2014.

transmission agreement means an agreement for connection and/or use of the **grid** and includes a **default transmission agreement** under subpart 2 of Part 12 (including, if relevant, an agreement for investment in the **grid**)

Clause 1.1(1) **transmission agreement**: amended, on 23 February 2015, by clause 75 of the Electricity Industry Participation Code Amendment (Distributed Generation) 2014.

Clause 1.1(1) **transmission agreement**: amended, on 5 October 2017, by clause 4(58) of the Electricity Industry Participation Code Amendment (Code Review Programme) 2017.

Clause 1.1(1) **transmission agreement**: amended, on 1 October 2023, by clause 4(5) of the Electricity Industry Participation Code Amendment (Default Transmission Agreement) 2023.

transmission alternative means an alternative to investment in the **grid**, including investment in local generation, energy efficiency, demand-side management and **distribution network** augmentation set out in Part 12

Clause 1.1(1) **transmission alternative**: inserted, on 15 May 2014, by clause 4(7)(b) of the Electricity Industry Participation (Minor Code Amendments) Code Amendment 2014.

transmission pricing methodology means the pricing methodology developed in accordance with subpart 4 of Part 12

transmission security constraint means a flow limit relating to the AC transmission system configuration, capacity and losses, including any adjustments that have been made in accordance with clause 13(2)(d) and (f) of Schedule 13.3, but excluding a flow limit set in relation to the **HVDC link**

Clause 1.1(1) **transmission security constraint**: amended, on 1 November 2022, by clause 4(10) of the Electricity Industry Participation Code Amendment (Real Time Pricing) 2022.

Transpower means Transpower New Zealand Limited

type A co-generator means the owner of a **type A industrial co-generating station**, in its capacity as owner of that **industrial co-generating station**

Clause 1.1(1) **type A co-generator**: inserted, on 27 May 2015, by clause 4(5) of the Electricity Industry Participation Code Amendment (Industrial Co-generation Dispatch Arrangements) 2015.

type A industrial co-generating station means an **industrial co-generating station** approved by the **Authority** under clause 8(1)(a)(i) of Schedule 13.4

Clause 1.1(1) **type A industrial co-generating station**: inserted, on 27 May 2015, by clause 4(5) of the Electricity Industry Participation Code Amendment (Industrial Co-generation Dispatch Arrangements) 2015.

type B co-generator means the owner of a **type B industrial co-generating station**, in its capacity as owner of that **industrial co-generating station**

Clause 1.1(1) **type B co-generator**: inserted, on 27 May 2015, by clause 4(5) of the Electricity Industry Participation Code Amendment (Industrial Co-generation Dispatch Arrangements) 2015.

type B industrial co-generating station means an **industrial co-generating station** approved by the **Authority** under clause 8(1)(a)(ii) of Schedule 13.4

Clause 1.1(1) **type B industrial co-generating station**: inserted, on 27 May 2015, by clause 4(5) of the Electricity Industry Participation Code Amendment (Industrial Co-generation Dispatch Arrangements) 2015.

type-testing means subjecting a sample or samples of a device to testing by an **approved test laboratory** accredited for the appropriate form of **type-testing** to verify compliance of that device with a prescribed standard or defined requirements, and **type-test** and **type-tested** have corresponding meaning

unacceptable overloading means that 1 or more **grid assets** exceed their stated capability, as set out in the **asset capability statements** for those **grid assets**, for the prevailing conditions, including without limitation ambient and seasonal temperature, pre-fault loading and time dependent loading cycles

unaccounted for electricity and **UFE** mean, for any **balancing area**, the quantity of **electricity**, as calculated per **trading period** by the **reconciliation manager** under clause 16 of Schedule 15.4.

unacceptable voltage conditions means voltages on the **grid** outside the limits specified in Part 8 of this Code

uncertainty means a parameter associated with the result of a measurement that characterises the dispersion of the values that could reasonably be attributed to the quantity being measured, and must be determined to a confidence level of 95% or greater unless otherwise specifically stated

unconstrained cleared offer price *[Revoked]*

Clause 1.1(1) **unconstrained cleared offer price**: revoked, on 1 November 2022, by clause 4(2) of the Electricity Industry Participation Code Amendment (Real Time Pricing) 2022.

under-frequency event means—

- (a) an interruption or reduction of **electricity** injected into the **grid**; or
- (b) an interruption or reduction of **electricity** injected from the **HVDC link** into the South Island **HVDC injection point** or the North Island **HVDC injection point**—

if there is, within any 60 second period, an aggregate loss of **injection of electricity** in excess of 60 **MW** (being the aggregate of the net reductions in the **injection of electricity** (expressed in **MW**) experienced at **grid injection points** and **HVDC injection points** by reason of paragraph (a) or (b)), and such loss causes the frequency on the **grid** (or any part of the **grid**) to fall below 49.25 Hz (as determined by **system operator** frequency logging)

under-frequency limit means the minimum frequency of 48hz for a contingent event

undesirable trading situation means any situation—

- (a) that threatens, or may threaten, confidence in, or the integrity of, the **wholesale market**; and
- (b) that, in the reasonable opinion of the **Authority**, cannot satisfactorily be resolved by any other mechanism available under this Code (but for the purposes of this paragraph a proceeding for a breach of clause 13.5A is not to be regarded as another mechanism for satisfactory resolution of a situation)

Clause 1.1(1) **undesirable trading situation**: substituted, on 18 July 2013, by clause 4(1) of the Electricity Industry Participation (Undesirable Trading Situation) Code Amendment 2013.

Clause 1.1(1) **undesirable trading situation**: amended, on 17 July 2014, by clause 4(2) of the Electricity Industry Participation Code Amendment (Pivotal Supply) 2014.

unit cost means the quantity calculated by dividing the product of the **consumer's half hour** consumption and the corresponding **half hour** prices over a defined time period by the sum of the **consumer's half hour** consumption over the same period of time (note that the **half hour** prices are based on the prices for trading at the **grid exit point** supplying energy to the **consumer**)

unmetered load means **electricity** consumed that is not directly recorded using a **meter**, but is calculated or estimated in accordance with this Code, and includes **shared unmetered load** and **distributed unmetered load**

un-modelled transmission asset means a **transmission asset** for which the **system operator's dispatch** optimisation model does not include **asset** ratings as a **constraint**

Clause 1.1(1) **un-modelled transmission asset**: inserted, at 12.00 pm on 19 September 2019, by clause 4(5) of the Electricity Industry Participation Code Amendment (Wind Offer Arrangements) 2019.

unoffered generation means **electricity** supplied from a **generating** station for which an **offer** has not been made in accordance with clause 13.25, but which is purchased by the **clearing manager**

unplanned interruption, for the purposes of Part 12, means an **interruption** caused by an **unplanned outage**

unplanned outage, for the purposes of Part 12, means an **outage** not planned in accordance with the planning requirements set out in the **Outage Protocol**

unsupplied demand situation means a situation in which—

- (a) there is **demand** at a **GXP**—
- (i) in a **price-responsive schedule**, for which price and quantity values have been assigned by the **system operator** under clause 13.58AA(1)(a); or
 - (ii) in a **non-response schedule**, for which price and quantity values have been assigned by the **system operator** under clause 13.58AA(1)(b); or
 - (iii) in a **dispatch schedule**, for which price and quantity values have been assigned by the **system operator** under clause 13.69AA; and
- (b) the **system operator** expects that the relevant **demand** will be unable to be supplied by **offers** in the relevant **price-responsive schedule**, **non-response schedule**, or **dispatch schedule**

Clause 1.1(1) **unsupplied demand situation**: inserted, on 1 November 2022, by clause 4(1) of the Electricity Industry Participation Code Amendment (Real Time Pricing) 2022.

use-of-system agreement [*Revoked*]

Clause 1.1(1) **use-of-system agreement**: inserted, on 1 December 2011, by clause 4(a) of the Electricity Industry Participation Code (Distributor Use-of-System Agreements and Distributor Tariffs) Amendment 2011.

Clause 1.1(1) **use-of-system agreement**: amended, on 1 February 2016, by clause 4(17) of the Electricity Industry Participation Code Amendment (Code Review Programme) 2015.

Clause 1.1(1) **use-of-system agreement**: revoked, on 20 July 2020, by clause 4(2) of the Electricity Industry Participation Code Amendment (Default Distributor Agreement) 2020.

validated meter reading means a **meter reading** that has passed a **reconciliation participant's** validation process in accordance with clauses 16 and 17 of Schedule 15.2

value of expected unserved energy means the value of any **expected unserved energy** that applies under clause 4 of Schedule 12.2 or clause 12.39

Clause 1.1(1) **value of expected unserved energy**: amended, on 1 February 2016, by clause 4(18) of the Electricity Industry Participation Code Amendment (Code Review Programme) 2015.

verification notice, for the purposes of subpart 5 of Part 13, means the notice provided by the **other party** in accordance with clause 13.226(2)(b) or (c)

voltage support means an **ancillary service** comprising **reactive power injection** to the power system to boost voltage at the point of injection

volume refresh, for the purposes of subpart 5B of Part 13, means the requirement in accordance with clause 13.236L(3) to refresh the number of **quotes** provided by that **participant**

Clause 1.1(1) **volume refresh**: inserted, on 1 September 2022, by clause 4(2) of the Electricity Industry Participation Code Amendment (Hedge Market Arrangements) 2022.

volume refresh period, for the purposes of subpart 5B of Part 13, means, for a particular **volume refresh**, the time period from the time the most recent buy or sell **quotes** were traded as **NZ electricity futures** until the time the **volume refresh** is completed

Clause 1.1(1) **volume refresh period**: inserted, on 1 September 2022, by clause 4(2) of the Electricity Industry Participation Code Amendment (Hedge Market Arrangements) 2022.

volume information means the information describing the quantity of **electricity** generated, conveyed, or consumed that is calculated or estimated from **raw meter data**

and supporting data, and in the case of **unmetered load**, calculated in accordance with this Code

washup means the correction procedure followed as set out in subpart 6 of Part 14 if incorrect information, including **volume information**, has been used in calculating an amount owing under Part 14

Clause 1.1(1) **washup**: amended, on 24 March 2015, by clause 4(1)(v) of the Electricity Industry Participation (Settlement and Prudential Security) Code Amendment 2013.

wholesale market means—

- (a) the spot market for **electricity**, including the processes for setting—
 - (i) *[Revoked]*:
 - (ii) **forecast prices** and **forecast reserve prices**:
 - (iii) *[Revoked]*:
 - (iv) **interim prices** and **interim reserve prices**:
 - (v) **final prices** and **final reserve prices**:(vi)**dispatch prices** and **dispatch reserve prices**:
- (b) markets for **ancillary services**:
- (c) the hedge market for **electricity**, including the market for **FTRs**

Clause 1.1(1) **wholesale market**: substituted, on 18 July 2013, by clause 4(2) of the Electricity Industry Participation (Undesirable Trading Situation) Code Amendment 2013.

Clause 1.1(1) **wholesale market**: subparagraphs (i) and (iii) revoked, on 1 November 2022, by clause 4(11)(a) of the Electricity Industry Participation Code Amendment (Real Time Pricing) 2022.

Clause 1.1(1) **wholesale market**: subparagraph (vi) inserted, on 1 November 2022, by clause 4(11)(b) of the Electricity Industry Participation Code Amendment (Real Time Pricing) 2022.

wind generating station means 1 or more **generating units** that are connected to the **grid** or to a **local network** and that inject into the **grid** or a **local network** (as the case may be) at a single point of **injection**, and for which wind is the primary power source

Clause 1.1(1) **wind generating station**: amended, on 23 February 2015, by clause 75 of the Electricity Industry Participation Code Amendment (Distributed Generation) 2014.

Clause 1.1(1) **wind generating station**: amended, on 5 October 2017, by clause 4(59) of the Electricity Industry Participation Code Amendment (Code Review Programme) 2017.

winter capacity margin means the difference between a measure of the expected capacity and expected demand from 1 April to 31 October between 7am and 10pm, expressed as a MW margin over demand

winter energy margin means the difference between the expected amount of energy that can be supplied and expected demand during the period 1 April to 30 September, expressed as a percentage of expected demand

WITS means the system operated by the **WITS manager**

Clause 1.1(1) **WITS**: inserted, on 5 October 2017, by clause 4(61) of the Electricity Industry Participation Code Amendment (Code Review Programme) 2017.

WITS manager means the **market operation service provider** for the time being appointed as wholesale information trading system provider under this Code

Clause 1.1(1) **WITS manager**: inserted, on 5 October 2017, by clause 4(61) of the Electricity Industry Participation Code Amendment (Code Review Programme) 2017.

working day *[Revoked]*

Clause 1.1(1) **working day**: revoked, on 5 October 2017, by clause 4(60) of the Electricity Industry Participation Code Amendment (Code Review Programme) 2017.

working standard means a measuring instrument that has been **calibrated** by an **approved calibration laboratory** or an **ATH**, that is used routinely for the **calibration of metering installations and metering components**

Clause 1.1(1) **working standard**: amended, on 29 August 2013, by clause 4(2)(v) of the Electricity Industry Participation (Metering Arrangements) Code Amendment 2011.

works has the meaning given to it in section 5 of the **Act**

year [*Revoked*]

Clause 1.1(1) **year**: revoked, on 5 October 2017, by clause 4(60) of the Electricity Industry Participation Code Amendment (Code Review Programme) 2017.

zone means the following **points of connection**:

- (a) zone 1: all **points of connection** to the **grid** in the North Island on circuits north of Huntly (excluding the Thames Valley spur):
 - (b) zone 2: all **points of connection** to the **grid** in the North Island not in zone 1:
 - (c) zone 3: all **points of connection** to the **grid** in the South Island on circuits north of (and not including) Islington, Coleridge, Hororata and Papanui:
 - (d) zone 4: all **points of connection** to the **grid** in the South Island not in zone 3
- (2) Any term that is defined in the **Act** and used, but not defined in this Code, has the same meaning as in the **Act**.

Compare: Electricity Governance Rules 2003 rule 1 part A

1.2 General principles of construction

In this Code—

- (a) a **participant** who carries on the functions or **business** of a **generator**, a **purchaser**, a **distributor**, a **grid owner** or a **market operation service provider** is, for the purpose of this Code, to be treated as a separate person for each such function or **business**, notwithstanding that at law all or any of the functions or **businesses** may be carried on by the same person; and
- (b) for the purpose of the arrangements expressed in this Code as to the supply and conveyance of **electricity** by a **generator** or a **purchaser** to another **generator** or **purchaser**, the supply and conveyance is deemed to have been made, notwithstanding that the physical flow of **electricity** from **generators** to **consumers** will not necessarily correspond with the contractual supply of **electricity** from **generators** to **purchasers**.

Compare: Electricity Governance Rules 2003 rule 2 part A

1.3 Special definition of “related”

For the purposes of this Code a person (the “first person”) is deemed to be related to another person (the “second person”) if the first person is related to the second person by reason of any domestic or **business** relationship (other than because the second person is a customer of the first person), such that the first person can reasonably be expected to have influence over the second person’s judgment in trading or investment matters, or to be consulted by the second person before any such judgment is formed, and if the first person is deemed to be so connected, the second person is also deemed to be related to the first person. No person is deemed to be related to any other person if

either person is a shareholding minister as that term is defined in section 2 of the State-Owned Enterprises Act 1986 or any other New Zealand legislation, provided that person is acting in his or her capacity as a shareholding minister.

Compare: Electricity Governance Rules 2003 rule 3 part A
Clause 1.3: amended, on 1 November 2018, by clause 4(11) of the Electricity Industry Participation Code Amendment (Code Review Programme) 2018.

1.4 Special definition of “independent”

A person is deemed to be independent for the purposes of this Code, unless the person—

- (a) is a director or employee of a **participant**; or
- (b) has a direct or indirect financial interest, whether legal or beneficial, and whether as a shareholder, a partner or another equity holder in a **participant**, other than an interest not greater than 0.1% of the equity capital or funds of the relevant entity or, if that entity is a **subsidiary** of another entity, of the other entity; or
- (c) is a director or employee of a shareholder, a partner or another equity holder referred to in paragraph (b); or
- (d) is a person who regularly or from time to time trades, directly or indirectly, under this Code.

Compare: Electricity Governance Rules 2003 rule 4 part A

1.5 Special definition of “purchaser” and “participant”

- (1) For any matter that relates to a **trading period** during which a notice given under subclause (2) is in effect, a reference in Parts 8, 13, 14, or 14A of this Code to a **purchaser** or a **participant** that incurs financial obligations under this Code or owes an amount to the **clearing manager**, if it refers to a **participant** who is described as participant B in the notice, must be read as a reference to the **participant** who is described as participant A in the notice.
- (2) A **participant** (participant A) may, by notice in the form set out in Schedule 1.1, give notice to the **Authority** that, from a date specified in the notice, participant A will assume all rights and obligations under Parts 8, 13, 14, and 14A of this Code of another **participant** named in the notice (participant B) in participant B’s capacity as a **purchaser** and a **participant** that incurs financial obligations under this Code or owes an amount to the **clearing manager**.
- (3) A notice given under subclause (2) takes effect from the first **trading period** on—
 - (a) the date specified in the notice, which must be at least 10 **business days** after the date that the notice is given to the **Authority**, or
 - (b) if the **Authority** reasonably considers additional time is required in any particular case, any later date specified by the **Authority** in a notice given to the **participant** (participant A) within 10 **business days** after the date the **Authority** receives the notice in subclause (2).
- (4) A notice given under subclause (2) does not take effect unless the **Authority** approves it by notice to the **clearing manager**, participant A, and participant B.
- (5) Participant A or participant B may revoke a notice given under subclause (2) by giving notice to the **Authority** in the form set out in Schedule 1.2.

- (6) A revocation takes effect from the first **trading period** on the date specified in the notice. That date must be at least 15 **business days** after the date that the notice is given to the **Authority**.
- (7) A notice given under subclauses (2) or (5) must be signed by both participant A and participant B.
- (8) The **Authority** must **publish** notice of—
 - (a) each approval given by the **Authority** under subclause (4); and
 - (b) each revocation under subclause (5).
- (9) If, but for this clause, a provision in Parts 8, 13, 14, or 14A of this Code would confer a right or impose an obligation on participant B in participant B's capacity as a **purchaser** or a **participant** that incurs financial obligations under this Code or owes an amount to the **clearing manager**, that provision must be read as conferring the right or imposing the obligation on participant A in respect of every **trading period** during which a notice under subclause (2) is in effect.
- (10) Participant A is able to comply with any obligation that arises from the operation of subclause (9) by complying in aggregate with its own obligations under this Code and obligations that arise from the operation of subclause (9).
- (11) To avoid doubt, for any **trading period** during which a notice under subclause (2) is in effect, participant A is deemed to be the person who buys **electricity** from the **clearing manager** for participant B.

Compare: Electricity Governance Rules 2003 rule 5 part A

Heading of clause 1.5: amended, on 24 March 2015, by clause 4(2)(a) of the Electricity Industry Participation (Settlement and Prudential Security) Code Amendment 2013.

Clause 1.5(1): amended, on 24 March 2015, by clause 4(2)(b) of the Electricity Industry Participation (Settlement and Prudential Security) Code Amendment 2013.

Clause 1.5(2): amended, on 24 March 2015, by clause 4(2)(c) of the Electricity Industry Participation (Settlement and Prudential Security) Code Amendment 2013.

Clause 1.5(9): amended, on 24 March 2015, by clause 4(2)(d) of the Electricity Industry Participation (Settlement and Prudential Security) Code Amendment 2013.

Clause 1.5(3): replaced, on 1 March 2024, by clause 5 of the Electricity Industry Participation Code Amendment (Code Review Programme) 2024.

1.5A Application of Code to distributors

Except in Parts 6, 9, and 12A, nothing in this Code applies to a **distributor** in respect of its **distribution** activities that are not conducted on a **network** that is—

- (a) directly connected to the **grid**; or
- (b) indirectly connected to the **grid** through 1 or more other **networks**.

Clause 1.5A: inserted, on 1 February 2016, by clause 5 of the Electricity Industry Participation Code Amendment (Code Review Programme) 2015.

Clause 1.5A: amended, on 5 October 2017, by clause 5 of the Electricity Industry Participation Code Amendment (Code Review Programme) 2017.

1.6 Contents tables

The contents tables that appear at the beginning of this Code, and at the beginning of each Part, are included only to assist in reading this Code, and do not form part of it.

1.7 Defined terms appear in bold

Words and phrases appear in bold in this Code only to alert the reader to the fact that they are defined in this Part.

Schedule 1.1

cl 1.5(2)

**Notice of assumption of rights and obligations under Parts 8, 13, 14,
and 14A of the Electricity Industry Participation Code 2010**

Heading: amended, on 24 March 2015, by clause 5(1) of the Electricity Industry Participation (Settlement and Prudential Security) Code Amendment 2013.

1. _____ (participant A) gives notice to the Electricity Authority under clause 1.5(2) of the Electricity Industry Participation Code 2010 that it will assume all rights and obligations of _____ (participant B) under Parts 8, 13, 14, and 14A of the Electricity Industry Participation Code 2010 in participant B's capacity as a purchaser and as a participant that incurs financial obligations under that Code or owes an amount to the clearing manager.
2. The notice given under clause 1 will, if approved by the Electricity Authority under clause 1.5(4) of the Electricity Industry Participation Code 2010, take effect from the first trading period on _____ and will continue until it is revoked by participant A or participant B under clause 1.5(5) of the Electricity Industry Participation Code 2010.

SIGNED for and on behalf of _____)
_____ by _____)
(participant A)

[insert name]

[insert occupation]

[insert date]

SIGNED for and on behalf of _____)
_____ by _____)
(participant B)

[insert name]

[insert occupation]

[insert date]

Compare: Electricity Governance Rules 2003 schedule A1 part A
Schedule 1.1: amended, on 24 March 2015, by clause 5(2) of the Electricity Industry Participation (Settlement and Prudential Security) Code Amendment 2013.

Schedule 1.1: amended, on 5 October 2017, by clause 6 of the Electricity Industry Participation Code Amendment (Code Review Programme) 2017.

Schedule 1.2

cl 1.5(5)

**Revocation of notice of assumption of rights and obligations under
Parts 8, 13, 14, and 14A of the Electricity Industry Participation Code
2010**

Heading: amended, on 24 March 2015, by clause 6(1) of the Electricity Industry Participation (Settlement and Prudential Security) Code Amendment 2013.

1. _____ gives notice to the Electricity Authority that the notice given to the Authority under clause 1.5(2) of the Electricity Industry Participation Code 2010 by _____ (participant A) on _____ that it would assume all rights and obligations under Parts 8, 13, 14, and 14A of the Electricity Industry Participation Code 2010 of _____ (participant B) in participant B's capacity as a purchaser and as a participant that incurs financial obligations under that Code or owes an amount to the clearing manager is revoked.
2. The revocation under clause 1 will take effect from the first trading period on _____.

SIGNED for and on behalf of _____)
_____ by _____)
(participant A)

[insert name]

[insert occupation]

[insert date]

SIGNED for and on behalf of _____)
_____ by _____)
(participant B)

[insert name]

[insert occupation]

[insert date]

Compare: Electricity Governance Rules 2003 schedule A2 part A
Schedule 1.2: amended, on 24 March 2015, by clause 6(2) of the Electricity Industry Participation (Settlement and Prudential Security) Code Amendment 2013.
Schedule 1.2: amended, on 5 October 2017, by clause 7 of the Electricity Industry Participation Code Amendment (Code Review Programme) 2017.

Electricity Industry Participation Code 2010

Part 2

Availability of information

Title Heading: amended, on 1 August 2022, by clause 4 of the Electricity Industry Participation Code Amendment (Regular and Event-Driven Provision of Information to the Authority) 2022.

Contents

Power to request Code information

- 2.1 Requests for Code information
 - Information held by Authority*
- 2.2 Information held by Authority
 - Information held by other participants*
- 2.3 Information not held by Authority
- 2.4 Authority must contact participant believed to hold requested information
- 2.5 Participant must consider request
- 2.6 Code information should be made available to all participants unless good reason
- 2.7 Other reasons
- 2.8 Transfer of requests
- 2.9 Participants must not enter contracts that prejudice supply of Code information
- 2.10 Decision about supplying information
- 2.11 Process if participant agrees to supply information
- 2.12 Charges payable
- 2.13 Documents may include deletions
- 2.14 Process if participant refuses to supply information
- 2.15 Appeal
 - Regular and event-driven provision of information to the Authority*
- 2.16 Authority may specify information that participants must collect, collate and/or provide regularly or in response to events
- 2.17 Requirements that the Authority must or may specify in a notice under clause 2.16
- 2.18 Authority must consult before publishing notice
- 2.19 Factors the Authority must consider before publishing notice
- 2.20 Participants must provide information to Authority
- 2.21 Participants may identify confidential information
- 2.22 Authority dealing with information identified as confidential
- 2.23 Privilege against self-incrimination
- 2.24 Authority may amend notice

Power to request Code information

2.1 Requests for Code information

- (1) A **participant** may request the **Authority** to make available to the **participant** (the requesting **participant**) any **Code information** held by the **Authority** or by any other **participant**.

- (2) The request must specify, with as much particularity as possible, the nature of the information sought and the name of the **participant** who is believed to hold the information.

Compare: SR 2003/374 r 15

Information held by Authority

2.2 Information held by Authority

If the **Authority** receives a request for the supply of **Code information** that the **Authority** holds, the **Authority** must—

- (a) consider and process the request in accordance with the Official Information Act 1982; and
- (b) if the **Authority** proposes to provide the information to the requester, give prior written notice to the **participant** that supplied the information to the **Authority**.

Compare: SR 2003/374 r 16

Clause 2.2(b): replaced, on 5 October 2017, by clause 8 of the Electricity Industry Participation Code Amendment (Code Review Programme) 2017.

Information held by other participants

2.3 Information not held by Authority

The rest of this Part applies if the **Authority** receives a request for the supply of **Code information** that the **Authority** does not hold.

Compare: SR 2003/374 r 17

2.4 Authority must contact participant believed to hold requested information

The **Authority** must, as soon as practicable after receiving a request for **Code information** that it does not hold, send a written notice to the **participant** who the **Authority** believes holds the relevant **Code information**—

- (a) giving the **participant** written notice of the request made to the **Authority**, and the name and address of the requesting **participant**; and
- (b) requesting the **participant** to either—
 - (i) supply the information, together with a note of the **participant's** charges (if any) in relation to the supply of information; or
 - (ii) supply reasons for refusing to supply the information.

Compare: SR 2003/374 r 18

Clause 2.4: amended, on 5 October 2017, by clause 9(1) of the Electricity Industry Participation Code Amendment (Code Review Programme) 2017.

Clause 2.4(a): amended, on 5 October 2017, by clause 9(2) of the Electricity Industry Participation Code Amendment (Code Review Programme) 2017.

2.5 Participant must consider request

A **participant** who receives a request under clause 2.4(b) must consider that request in accordance with clauses 2.6 to 2.8.

Compare: SR 2003/374 r 19

2.6 Code information should be made available to all participants unless good reason

- (1) The general principle to be followed by **participants** in relation to **Code information** is that **Code information** should be made available to all **participants** unless there is good reason for refusing to supply it.
- (2) A **participant** has good reason for refusing to supply **Code information** if the supply of the information would be likely to—
 - (a) breach a legislative, regulatory, or other legal requirement; or
 - (b) prejudice the maintenance and supervision of this Code, including the prevention, investigation, and detection of Code breaches and the right to a fair hearing before the **Rulings Panel**; or
 - (c) result in a disclosing **participant** breaching an obligation of confidentiality; or
 - (d) interfere with the privacy of natural persons; or
 - (e) create an improper gain or improper advantage for the requesting **participant** or any other **participant** or person; or
 - (f) commercially disadvantage the disclosing **participant** or any other **participant** or person, in a material manner; or
 - (g) prejudice the future supply of information that is required by a **market operation service provider** to perform any obligation under this Code.

Compare: SR 2003/374 r 20

2.7 Other reasons

A **participant** may also refuse to supply **Code information** if—

- (a) the information requested is, or will soon be, made available to the public; or
- (b) the information requested does not exist or cannot be found; or
- (c) the information requested cannot be made available without substantial collation or research and the **Authority** agrees that it is unreasonable to undertake the collation or research; or
- (d) the request is frivolous or vexatious or the information requested is trivial.

Compare: SR 2003/374 r 21

Clause 2.7(a): amended, on 5 October 2017, by clause 10 of the Electricity Industry Participation Code Amendment (Code Review Programme) 2017.

2.8 Transfer of requests

- (1) This clause applies if—
 - (a) a notice is sent to a **participant** under clause 2.4(b); and
 - (b) the information to which the request relates—
 - (i) is not held by the **participant** but is believed by the person dealing with the notice to be held by another **participant**; or
 - (ii) is believed by the person dealing with the notice to be more closely related to the activities of another **participant**.
- (2) The **participant** to which the notice was sent must promptly, and in any case not later than **10 business days** after the day on which the notice is received, transfer the notice to the other **participant**, and inform the **Authority** accordingly.

Compare: SR 2003/374 r 22

Clause 2.8(1)(b)(ii): amended, on 5 October 2017, by clause 11(1) of the Electricity Industry Participation Code Amendment (Code Review Programme) 2017.

Clause 2.8(2): amended, on 5 October 2017, by clause 11(2) of the Electricity Industry Participation Code Amendment (Code Review Programme) 2017.

2.9 Participants must not enter contracts that prejudice supply of Code information

A **participant** must, so far as is reasonably practicable without materially affecting its business or its ability to meet its obligations under this Code, avoid entering into an obligation with a person that would have the effect of prejudicing that **participant's** ability to comply freely with the provisions of this Part.

Compare: SR 2003/374 r 23

2.10 Decision about supplying information

A **participant** must, as soon as practicable after considering a request, inform the **Authority** and the requesting **participant** of whether it agrees or refuses to supply all or part of the **Code information** requested.

Compare: SR 2003/374 r 24

2.11 Process if participant agrees to supply information

- (1) If a **participant** agrees to supply all or part of the **Code information** requested, the **participant** must, as soon as practicable,—
 - (a) inform the **Authority** and the requesting **participant** of the information that will be supplied, and the amount of any charges to be paid for the supply of that information under clause 2.12; and
 - (b) supply that information, with any deletions authorised by clause 2.13, to the **Authority**.
- (2) The **Authority** must, as soon as practicable after receiving the information, and any charges required to be paid in respect of it by the requesting **participant**, send the information to the requesting **participant**.

Compare: SR 2003/374 r 25

2.12 Charges payable

- (1) A **participant** that supplies **Code information** may charge the requesting **participant** for—
 - (a) the reasonable cost of labour and materials involved in supplying the information to the requesting **participant**; and
 - (b) any additional costs incurred as a result of a request for urgent availability.
- (2) The **participant** that supplies the **Code information**, or the **Authority**, may require the whole or any part of the charge to be paid in advance by the requesting **participant**.

Compare: SR 2003/374 r 26

2.13 Documents may include deletions

If the **Code information** requested is contained in a **document**, and there are good reasons for refusing to supply some of the information contained in the **document**, the **participant** supplying the information may supply a copy of the **document** with any deletions or alterations that are necessary.

Compare: SR 2003/374 r 27

2.14 Process if participant refuses to supply information

- (1) If the **participant** refuses to supply all or any of the **Code information** requested, the **participant** must, as soon as practicable, give written notice to the **Authority** and the requesting **participant** of both the refusal and of the reasons for the refusal.
- (2) The **Authority** must, as soon as practicable after receiving the notice, advise the requesting **participant** of its rights to appeal under clause 2.15.

Compare: SR 2003/374 r 28

Clause 2.14(1): amended, on 5 October 2017, by clause 12(1) of the Electricity Industry Participation Code Amendment (Code Review Programme) 2017.

Clause 2.14(2): amended, on 5 October 2017, by clause 12(2) of the Electricity Industry Participation Code Amendment (Code Review Programme) 2017.

2.15 Appeal

A requesting **participant** who receives written notice under clause 2.14 that another **participant** refuses to supply any **Code information** may appeal that refusal by notice of appeal to the **Rulings Panel**.

Compare: SR 2003/374 r 29

Clause 2.15: amended, on 5 October 2017, by clause 13 of the Electricity Industry Participation Code Amendment (Code Review Programme) 2017.

Regular and event-driven provision of information to the Authority

Subheading: inserted, on 1 August 2022, by clause 6 of the Electricity Industry Participation Code Amendment (Regular and Event-Driven Provision of Information to the Authority) 2022.

2.16 Authority may specify information that participants must collect, collate and/or provide regularly or in response to events

- (1) The **Authority** may **publish** a notice specifying information that a **participant** must, on a regular basis or as a result of an identified event, provide to the **Authority**.
- (2) The **Authority** may specify information under subclause (1) only for the purposes set out in section 45(a) of the **Act** being to carry out the **Authority's** monitoring functions which are to—
 - (a) monitor compliance with the **Act**, the regulations and the Code under section 16(1)(c) of the **Act**; or
 - (b) undertake and monitor the operation and effectiveness of market-facilitation measures under section 16(1)(f) of the **Act**; or
 - (c) undertake industry and market monitoring, and carry out and make publicly available reviews, studies, and inquiries into any matter relating to the electricity industry, under section 16(1)(g) of the **Act**.
- (3) The **Authority** may not specify information under subclause (1) for the purpose of investigating or enforcing compliance with the **Act**, the regulations and the Code except that it may use information obtained under a notice **published** under subclause (1) in the course of making a decision to appoint an investigator under regulation 12 of the Electricity Industry (Enforcement) Regulations 2010.

Clause 2.16: inserted, on 1 August 2022, by clause 6 of the Electricity Industry Participation Code Amendment (Regular and Event-Driven Provision of Information to the Authority) 2022.

Clause 2.16(2)(a) & (3): amended, on 1 March 2024, by clause 6(1) & (2) of the Electricity Industry Participation Code Amendment (Code Review Programme) 2024.

2.17 Requirements that the Authority must or may specify in a notice under clause 2.16

- (1) In a notice **published** under clause 2.16, the **Authority** must specify the following information requirements:
 - (a) the **participant** who must provide the information:
 - (b) the information the **Authority** requires the **participant** to provide, to a reasonable level of detail:
 - (c) either:
 - (i) the time and/or the frequency at which the **participant** must provide the information to the **Authority**; or
 - (ii) the event following which the **participant** must provide the information to the **Authority** and the time by which the **participant** must provide the information
 - (d) the manner in which the **participant** must provide the information to the **Authority**:
 - (e) the date from which the notice applies, which can be different dates for different **participants**.
- (2) In a notice **published** under clause 2.16, the **Authority** may specify 1 or more standard formats in which the **participant** must provide the information to the **Authority**.
Clause 2.17: inserted, on 1 August 2022, by clause 6 of the Electricity Industry Participation Code Amendment (Regular and Event-Driven Provision of Information to the Authority) 2022.

2.18 Authority must consult before publishing notice

- (1) Before **publishing** a notice under clause 2.16, the **Authority** must provide to the **participant** to whom the proposed notice applies—
 - (a) the proposed notice; and
 - (b) the **Authority**'s purpose in setting the information requirements in the proposed notice; and
 - (c) the **Authority**'s assessment of the likely benefits of the **Authority** obtaining the information required in the proposed notice and whether those benefits are expected to outweigh the likely costs.
- (2) The **Authority** must give that **participant** a reasonable opportunity to make submissions to the **Authority** on the proposed notice and take into account those submissions in deciding whether to—
 - (a) make any reasonable changes to the information requirements to be included in the **published** notice; and
 - (b) **publish** the notice.
- (3) The **Authority** may, but is not required to, consult with any other person the **Authority** wishes, following whatever consultation process the **Authority** considers appropriate.
- (4) If, following the consideration of submissions under subclause (2), the **Authority** proposes to extend the number of **participants** to whom it proposes the notice will

apply, the **Authority** must consult with those additional **participants** following the process in subclauses (1) and (2) if it has not already.

Clause 2.18: inserted, on 1 August 2022, by clause 6 of the Electricity Industry Participation Code Amendment (Regular and Event-Driven Provision of Information to the Authority) 2022.

2.19 Factors the Authority must consider before publishing notice

- (1) Before **publishing** a notice under clause 2.16, the **Authority** must be satisfied that—
 - (a) the benefits of the **Authority** obtaining the information outweigh the costs of the information requirements set out in the proposed notice; and
 - (b) the information requirements set out in the proposed notice promote one or more of the **Authority's** objectives in section 15 of the **Act**.
- (2) Before **publishing** a notice under clause 2.16, the **Authority** must consider the impact of the proposed information requirements on each **participant** to whom it is proposed the notice apply.

Clause 2.19: inserted, on 1 August 2022, by clause 6 of the Electricity Industry Participation Code Amendment (Regular and Event-Driven Provision of Information to the Authority) 2022.

Clause 2.19(1)(b): amended, on 1 March 2024, by clause 7 of the Electricity Industry Participation Code Amendment (Code Review Programme) 2024.

2.20 Participants must provide information to Authority

- (1) If the **Authority publishes** a notice under clause 2.16, each **participant** to whom the notice applies must—
 - (a) collect and record the information specified in the notice; and
 - (b) collate from its own systems, records and/or information the information specified in the notice; and
 - (c) provide to the **Authority** the information specified in the notice; and
 - (d) meet the other information requirements specified in the notice.
- (2) A **participant** does not need to provide any information to the **Authority** under subclause (1)(c) if—
 - (a) the **participant** has legal professional privilege in respect of the information; or
 - (b) it is not reasonably possible for the **participant** to obtain that information, including because the person that holds the information may lawfully refuse to provide the information to the **participant**.

Clause 2.20: inserted, on 1 August 2022, by clause 6 of the Electricity Industry Participation Code Amendment (Regular and Event-Driven Provision of Information to the Authority) 2022.

2.21 Participants may identify confidential information

- (1) In supplying information under clause 2.20, a **participant** may identify any information for which confidentiality is sought by reason that—
 - (a) disclosure of the information would unreasonably prejudice the commercial position of the **participant** or the person who is the subject of that information; or
 - (b) confidentiality is necessary to protect information which is itself subject to an obligation of confidence; or

- (c) if clause 2.20 did not apply, disclosure of the information by the **participant** would be in breach of law.

Clause 2.21: inserted, on 1 August 2022, by clause 6 of the Electricity Industry Participation Code Amendment (Regular and Event-Driven Provision of Information to the Authority) 2022.

2.22 Authority dealing with information identified as confidential

- (1) If a **participant** identifies to the **Authority** any information under clause 2.21, the **Authority** will determine whether—
- (a) there are reasons for keeping the information confidential; and
 - (b) if there are reasons to keep the information confidential as determined by the **Authority**, those reasons are outweighed by other considerations which render it desirable for the **Authority** to make all or any part of the information publicly available in order to give effect to one or more of the **Authority's** objectives in section 15 of the **Act** and for the purposes of any of the **Authority's** functions in either:
 - (i) section 16 of the **Act**; or
 - (ii) section 14 of the Crown Entities Act 2004.
- (2) If the **Authority** does not consider under subclause 1(a) that there are reasons for keeping the information confidential, the **Authority** is not required to keep the information confidential.
- (3) If the **Authority** considers that it is desirable under subclause 1(b) to make all or any part of the information publicly available, the **Authority**—
- (a) is not required to keep the information confidential; and
 - (b) will inform the **participant** of that decision, provided that doing so is reasonably possible in the circumstances and does not compromise the reasons for making the information publicly available.
- (4) If the **Authority** considers under subclause 1(a) that there are reasons for keeping the information confidential and does not consider that it is desirable under subclause 1(b) to make all or any part of the information publicly available, subject to subclause (5), the **Authority** must keep the information identified by a **participant** under clause 2.21 confidential.
- (5) Subclause (4) does not prevent the **Authority** from—
- (a) using the information identified under clause 2.21 for any purpose in connection with one or more of the **Authority's** objectives in section 15 of the **Act** or the **Authority's** functions in section 16 of the **Act** or section 14 of the Crown Entities Act 2004; or
 - (b) disclosing the information to any person in connection with a purpose referred to in paragraph (a) in anonymised form or in consolidated form with other information such that the reasons for keeping the information confidential are not compromised; or

- (c) disclosing the information where the **participant** who supplied the information or the person who is the subject of the information (if different from the **participant**) either:
- (i) has consented specifically to the disclosure of that information; or
 - (ii) has consented generally to the disclosure, even where the **participant** identifies the information as confidential under clause 2.21, of:
 - (A) information specified in the notice **published** under clause 2.16 under which the **participant** supplied the information to the **Authority**; or
 - (B) a category of information specified in the notice **published** under clause 2.16 under which the **participant** supplied the information and the **Authority** reasonably considers the information that it intends to disclose comes within that category; or
- (d) disclosing the information as required by or under law.

Clause 2.22: inserted, on 1 August 2022, by clause 6 of the Electricity Industry Participation Code Amendment (Regular and Event-Driven Provision of Information to the Authority) 2022.

Clause 2.22(1)(b): amended, on 1 March 2024, by clause 8(1) of the Electricity Industry Participation Code Amendment (Code Review Programme) 2024.

Clause 2.22(5)(a): amended, on 1 March 2024, by clause 8(2) of the Electricity Industry Participation Code Amendment (Code Review Programme) 2024.

2.23 Privilege against self-incrimination

The **Authority** must comply with section 48(2) and 48(3) of the **Act** in respect of information that is subject to privilege against self-incrimination.

Clause 2.23: inserted, on 1 August 2022, by clause 6 of the Electricity Industry Participation Code Amendment (Regular and Event-Driven Provision of Information to the Authority) 2022

2.24 Authority may amend notice

- (1) The **Authority** may amend a notice **published** under clause 2.16 following the procedure set out in clause 2.18 and complying with clause 2.19.
- (2) The **Authority** does not need to consult under clause 2.18 on a proposed amendment to a notice if it is satisfied on reasonable grounds that—
 - (a) the nature of the amendment is technical and non-controversial; or
 - (b) there is widespread support for the amendment among the **participants** to whom the notice applies and to whom the proposed amendment will apply; or
 - (c) there has been adequate prior consultation (for instance, by or through an advisory group) so that all relevant views have been considered.

Clause 2.24: inserted, on 1 August 2022, by clause 6 of the Electricity Industry Participation Code Amendment (Regular and Event-Driven Provision of Information to the Authority) 2022.

Electricity Industry Participation Code 2010

Part 3 Market operation service providers

Contents

- 3.1 Appointment of market operation service providers
- 3.2 Functions, rights, powers, and obligations of market operation service providers
- 3.2A Market operation service providers to assist Authority to give effect to Authority's main statutory objective
- 3.3 Term of appointment of market operation service provider
- 3.4 Terms of market operation service provider agreements
- 3.5 Publication of market operation service provider agreements
- 3.6 Insurance cover
 - Force majeure provisions relating to market operation service providers*
- 3.7 Relief of obligation because of force majeure
- 3.8 Effect of relief
- 3.9 Authority may contract elsewhere during force majeure event
- 3.10 Authority may terminate market operation service provider agreements
 - Disclosure to Authority*
- 3.11 Disclosure to Authority
 - Performance standards*
- 3.12 Performance standards to be agreed
 - Accountability of market operation service providers via self-review*
- 3.13 Self-review must be carried out by market operation service providers
- 3.14 Market operation service providers must report to Authority
- 3.14A Market operation service providers to self-report breaches to Authority
 - Review of market operation service providers by Authority*
- 3.15 Review of market operation service providers
 - Market operation service provider software*
- 3.16 Software specifications for market operation service providers
- 3.17 Market operation service provider must arrange audit of software
- 3.18 Requirements for using software

3.1 Appointment of market operation service providers

- (1) The **Authority** must appoint a person or persons to perform each of the following **market operation service provider** roles:
 - (a) **registry manager:**
 - (b) **reconciliation manager:**
 - (c) *[Revoked]:*
 - (d) **clearing manager:**
 - (e) **FTR manager:**
 - (f) **WITS manager:**
 - (g) *[Revoked]:*

- (h) any other role identified in regulations as a **market operation service provider** role and for which market operation services are provided under this Code.
- (2) *[Revoked]*.
- (3) The **system operator** is also a **market operation service provider**, but clauses 3.3, 3.10 and 3.15 do not apply to the **system operator**.
- (4) The **Authority** may also appoint a person or persons to act as an industry service provider in providing any service under this Code.

Compare: SR 2003/374 r 30

Clause 3.1(3): amended, on 19 May 2016, by clause 5 of the Electricity Industry Participation Code Amendment (System Operator and Alignment with Statutory Objective) 2016.

Clause 3.1(1): substituted, on 5 October 2017, by clause 14(1) of the Electricity Industry Participation Code Amendment (Code Review Programme) 2017.

Clause 3.1(1)(g): revoked, on 21 December 2021, by clause 5 of the Electricity Industry Participation Code Amendment (Automatic Under-Frequency Load Shedding Systems) 2021.

Clause 3.1(2): revoked, on 5 October 2017, by clause 14(2) of the Electricity Industry Participation Code Amendment (Code Review Programme) 2017.

Clause 3.1(1)(c): revoked, on 1 November 2022, by clause 5 of the Electricity Industry Participation Code Amendment (Real Time Pricing) 2022.

3.2 Functions, rights, powers, and obligations of market operation service providers

A **market operation service provider** has the functions, rights, powers, and obligations set out in relation to that **market operation service provider** under this Code and Part 2 and Subpart 1 of Part 4 of the **Act**.

Compare: SR 2003/374 r 31

Clause 3.2: amended, on 5 October 2017, by clause 15 of the Electricity Industry Participation Code Amendment (Code Review Programme) 2017.

3.2A Market operation service providers to assist Authority to give effect to Authority's main statutory objective

- (1) Each **market operation service provider** must perform its obligations under this Code in a way that assists the **Authority** to give effect to the **Authority's** main objective in section 15 of the **Act**.
- (2) The **system operator** must progressively increase the extent to which it assists the **Authority** to give effect to the **Authority's** main objective in section 15 of the **Act**.
- (3) The **system operator** is not required to comply with subclause (1) when exercising discretion in real time in performing its functions.
- (4) This clause does not permit a **market operation service provider** to contravene any other provision of this Code.

Clause 3.2A: inserted, on 19 May 2016, by clause 6 of the Electricity Industry Participation Code Amendment (System Operator and Alignment with Statutory Objective) 2016.

Clause 3.2A Heading: amended, on 1 March 2024, by clause 9(1) of the Electricity Industry Participation Code Amendment (Code Review Programme) 2024.

Clause 3.2A(1) and (2): amended, on 1 March 2024, by clause 9(2) of the Electricity Industry Participation Code Amendment (Code Review Programme) 2024.

3.3 Term of appointment of market operation service provider

- (1) A **market operation service provider's** term of appointment, and the date on which the term begins, is as agreed between the **Authority** and the **market operation service provider**.

- (2) The **Authority** may at any time terminate, re-appoint, or change the appointment of a person as a **market operation service provider**, subject to the terms of any agreement between that **market operation service provider** and the **Authority**.

Compare: SR 2003/374 r 32(1) and (2)

3.4 Terms of market operation service provider agreements

- (1) The remuneration of a **market operation service provider** is as agreed between the **Authority** and the **market operation service provider**.
- (2) The **Authority** and the **market operation service provider** may agree on any other terms and conditions, not inconsistent with the functions, rights, powers, and obligations of that **market operation service provider** under this Code and Part 2 and Subpart 1 of Part 4 of the **Act**.

Compare: SR 2003/374 r 33

Clause 3.4(2): amended, on 19 December 2014, by clause 5 of the Electricity Industry Participation Code Amendment (Minor Code Amendments) (No 3) 2014.

Clause 3.4(2): amended, on 5 October 2017, by clause 16 of the Electricity Industry Participation Code Amendment (Code Review Programme) 2017.

3.5 Publication of market operation service provider agreements

The **Authority** must **publish** each **market operation service provider agreement**.

Compare: SR 2003/374 r 34

Clause 3.5: amended, on 5 October 2017, by clause 17 of the Electricity Industry Participation Code Amendment (Code Review Programme) 2017.

3.6 Insurance cover

Each **market operation service provider** must at all times maintain any insurance cover that is required by the **Authority**, on terms and in respect of risks approved by the **Authority**, with an insurer approved by the **Authority**.

Compare: SR 2003/374 r 36

Force majeure provisions relating to market operation service providers

3.7 Relief of obligation because of force majeure

- (1) A **market operation service provider** is relieved of an obligation under this Code and under the Electricity Industry (Enforcement) Regulations 2010 to the extent that, and for so long as, it is unable to perform the obligation as a result of a **force majeure event**.
- (2) Subclause (1) applies only—
- if the **market operation service provider** promptly advises the **Authority** of—
 - the details of the **force majeure event**; and
 - the obligation that cannot be performed; and
 - the likely duration of the inability to perform the obligation; and
 - for so long as the **market operation service provider** uses its reasonable endeavours to overcome the inability to perform the obligation from which it seeks relief and to remove or mitigate the effect of the **force majeure event**; and
 - if the **market operation service provider** provides the **Authority** with reports in accordance with subclauses (3) and (4).

- (3) As soon as practicable, but in any event no later than by the end of the month following the month in which the **market operation service provider** advises the **Authority** of a **force majeure event** under subclause (2)(a), the **market operation service provider** must provide the **Authority** with a written report that sets out—
 - (a) the full details of the **force majeure event**; and
 - (b) the actions the **market operation service provider** is taking or intends to take to comply with subclause (2)(b); and
 - (c) the proposed timeline for completing the actions.
- (4) By the end of each following month (unless the **Authority** advises that reports may be provided less frequently or are not required) the **market operation service provider** must provide the **Authority** with a written report that updates the information previously provided and includes any other matters related to the **force majeure event** that the **Authority** requests.
- (5) The **Authority** must **publish** the information provided under subclause (2)(a) and the reports provided under subclauses (3) and (4) as soon as practicable after receiving the information.
- (6) Despite subclause (5), the **Authority** must not **publish** or otherwise make available to the public any information or any part of a report if the **market operation service provider** advises the **Authority** (with reasons) that the **market operation service provider** considers that it would have good reason to refuse to supply the information or the part under clause 2.6 or clause 2.7.

Compare: SR 2003/374 r 38

Clause 3.7: substituted, on 1 November 2012, by clause 5 of the Electricity Industry Participation (Force Majeure) Code Amendment 2012.

Clause 3.7(5): amended, on 5 October 2017, by clause 18(1) of the Electricity Industry Participation Code Amendment (Code Review Programme) 2017.

Clause 3.7(6): amended, on 5 October 2017, by clause 18(2) of the Electricity Industry Participation Code Amendment (Code Review Programme) 2017.

3.8 Effect of relief

If a **market operation service provider** is relieved of an obligation under clause 3.7,—

- (a) the **market operation service provider** is not liable for a breach of this Code or with the Electricity Industry (Enforcement) Regulations 2010 in respect of that obligation during the period for which the relief applies under that clause; and
- (b) any costs arising from the relief from the obligation lie where they fall, except that the **Authority** and the **market operation service provider** may agree to adjust the remuneration of the **market operation service provider**.

Compare: SR 2003/374 r 39

Clause 3.8(a): amended, on 1 November 2012, by clause 6 of the Electricity Industry Participation (Force Majeure) Code Amendment 2012.

3.9 Authority may contract elsewhere during force majeure event

For the duration of a **force majeure event**, the **Authority** may contract with others for the performance of an obligation that the **market operation service provider** fails to perform in accordance with this Code or with the Electricity Industry (Enforcement) Regulations 2010, or the relevant **market operation service provider agreement**.

Compare: SR 2003/374 r 40

Clause 3.9: amended, on 1 November 2012, by clause 7 of the Electricity Industry Participation (Force Majeure) Code Amendment 2012.

3.10 Authority may terminate market operation service provider agreements

If a **force majeure event** results in a **market operation service provider** being relieved of a material obligation for more than 30 continuous days, the **Authority** may terminate the relevant **market operation service provider agreement** by written notice with immediate effect.

Compare: SR 2003/374 r 41(1)

Disclosure to Authority

3.11 Disclosure to Authority

Each **market operation service provider** is entitled to disclose to the **Authority** all information received by it from any person as part of its provision of services under this Code and Part 2 and Subpart 1 of Part 4 of the **Act**.

Compare: SR 2003/374 r 42

Clause 3.11: amended, on 5 October 2017, by clause 19 of the Electricity Industry Participation Code Amendment (Code Review Programme) 2017.

Performance standards

3.12 Performance standards to be agreed

The **Authority** and the relevant **market operation service provider** must, at the beginning of each year ending 30 June, seek to agree on a set of performance standards against which the **market operation service provider's** actual performance must be reported and measured at the end of the year ending 30 June.

Compare: SR 2003/374 r 43

Clause 3.12: amended, on 5 October 2017, by clause 20 of the Electricity Industry Participation Code Amendment (Code Review Programme) 2017.

Accountability of market operation service providers via self-review

3.13 Self-review must be carried out by market operation service providers

- (1) Each **market operation service provider** must conduct, on a monthly basis, a self-review of its performance.
- (2) The review must concentrate on the **market operation service provider's** compliance with—
 - (a) its obligations under this Code and Part 2 and Subpart 1 of Part 4 of the **Act**; and
 - (b) the operation of this Code and Part 2 and Subpart 1 of Part 4 of the **Act**; and
 - (c) any performance standards agreed between the **market operation service provider** and the **Authority**; and
 - (d) the provisions of the **market operation service provider agreement**.

Compare: SR 2003/374 r 44

Clause 3.13(2)(a) and (b): amended, on 5 October 2017, by clause 21 of the Electricity Industry Participation Code Amendment (Code Review Programme) 2017.

3.14 Market operation service providers must report to Authority

- (1) Each **market operation service provider** must prepare a written report for the **Authority** on the results of the review carried out under clause 3.13.
- (1A) A **market operation service provider** must provide the report prepared under subclause (1) to the **Authority**—
 - (a) within 10 **business days** after the end of each calendar month except after the month of December;
 - (b) within 20 **business days** after the end of the month of December.
- (2) The report must contain details of—
 - (a) any circumstances identified by the **market operation service provider** in which it has failed, or may have failed, to comply with its obligations under this Code and Part 2 and Subpart 1 of Part 4 of the **Act**; and
 - (b) any event or series of events that, in the **market operation service provider's** view, highlight an area where a change to this Code may need to be considered; and
 - (c) any other matters that the **Authority**, in its reasonable discretion, considers appropriate and asks the **market operation service provider**, in writing within a reasonable time before the report is provided, to report on.

Compare: SR 2003/374 r 45

Clause 3.14(1): replaced, on 5 October 2017, by clause 22(1) of the Electricity Industry Participation Code Amendment (Code Review Programme) 2017.

Clause 3.14(1A): inserted, on 5 October 2017, by clause 22(1) of the Electricity Industry Participation Code Amendment (Code Review Programme) 2017.

Clause 3.14(2)(a): amended, on 5 October 2017, by clause 22(2) of the Electricity Industry Participation Code Amendment (Code Review Programme) 2017.

3.14A Market operation service providers to self-report breaches to Authority

- (1) If a **market operation service provider** believes on reasonable grounds that it has breached a provision of this Code, the **market operation service provider** must report the alleged breach to the **Authority** in writing as soon as practicable after the **market operation service provider** becomes aware of the alleged breach.
- (2) The written report must specify—
 - (a) the provision of this Code allegedly breached; and
 - (b) the date and time the alleged breach occurred; and
 - (c) the circumstances relating to the alleged breach, including any **participants** the **market operation service provider** believes the alleged breach may have affected.

Clause 3.14A: inserted, on 1 November 2018, by clause 5 of the Electricity Industry Participation Code Amendment (Code Review Programme) 2018.

Review of market operation service providers by Authority

3.15 Review of market operation service providers

- (1) At the end of each year ending 30 June, the **Authority** may review the manner in which each **market operation service provider** has performed its duties and obligations under this Code and Part 2 and Subpart 1 of Part 4 of the **Act**.

- (2) The review must concentrate on the **market operation service provider's** compliance with—
- (a) its obligations under this Code and Part 2 and Subpart 1 of Part 4 of the **Act**; and
 - (b) the operation of this Code and Part 2 and Subpart 1 of Part 4 of the **Act**; and
 - (c) any performance standards agreed between the **market operation service provider** and the **Authority**; and
 - (d) the provisions of the **market operation service provider agreement**.

Compare: SR 2003/374 r 46

Clause 3.15: amended, on 5 October 2017, by clause 23 of the Electricity Industry Participation Code Amendment (Code Review Programme) 2017.

Market operation service provider software

3.16 Software specifications for market operation service providers

- (1) This clause and clauses 3.17 and 3.18, apply only to **software** that the **market operation service provider agreement** requires the **market operation service provider** to use.
- (2) Unless otherwise agreed by the **Authority** in writing, the **software specification** for all **software** to be used by a **market operation service provider** must be set out or described in the **market operation service provider agreement** for that **market operation service provider**.
- (3) Each **market operation service provider** must ensure that its **software** performs in accordance with the relevant **software specification** and this Code.

Compare: SR 2003/374 r 51(1AA) to (2)

3.17 Market operation service provider must arrange audit of software

- (1) Unless otherwise agreed by the **Authority** in writing, each **market operation service provider** must arrange and pay for a suitably qualified independent person approved by the **Authority** to carry out—
- (a) before any **software** is first used by the **market operation service provider** in relation to this Code and Part 2 and Subpart 1 of Part 4 of the **Act**, an **audit** of all **software** and **software specifications** to be used by the **market operation service provider**; and
 - (b) an annual **audit** of all **software** used by the **market operation service provider**, within 1 month after 1 March in each year; and
 - (c) an **audit** of any changes to the **software** or the **software specification**, before it is used by the **market operation service provider**.
- (2) A **market operation service provider** must ensure that the person carrying out an **audit** under subclause (1) provides a report to the **Authority** as to—
- (a) the performance (including likely future performance) of all of the **software** in accordance with the relevant **software specification**; and
 - (b) any other matters that the **Authority** requires.

Compare: SR 2003/374 r 52

Clause 3.17(2): amended, on 1 February 2016, by clause 6 of the Electricity Industry Participation Code Amendment (Code Review Programme) 2015.

Clause 3.17(1)(a): amended, on 5 October 2017, by clause 24 of the Electricity Industry Participation Code Amendment (Code Review Programme) 2017.

3.18 Requirements for using software

A **market operation service provider** may not use any **software** unless—

- (a) the **market operation service provider** has provided to the **Authority**, in respect of that **software**, an **auditor's** report issued in accordance with clause 3.17(2); or
- (b) the **Authority** has agreed that no **audit** is required under clause 3.17(1).

Compare: SR 2003/374 r 53

Electricity Industry Participation Code 2010

Part 4

Force majeure provisions relating to ancillary service agents

Contents

- 4.1 Relief of obligation because of force majeure
 - 4.2 Effect of relief
-

4.1 Relief of obligation because of force majeure

- (1) An **ancillary service agent** is relieved of an obligation under this Code and under the Electricity Industry (Enforcement) Regulations 2010 to the extent that, and for so long as, it is unable to perform the obligation as a result of a **force majeure event**.
- (2) Subclause (1) applies only—
 - (a) if the **ancillary service agent** advises the **system operator**, immediately after becoming aware of the existence of a **force majeure event**, of—
 - (i) the details of the **force majeure event**; and
 - (ii) the obligation that cannot be performed; and
 - (iii) the likely duration of the inability to perform the obligation; and
 - (b) for so long as the **ancillary service agent** uses its reasonable endeavours to overcome the inability to perform the obligation from which it seeks relief and to remove or mitigate the effect of the **force majeure event**; and
 - (c) if the **ancillary service agent** provides the **Authority** with reports in accordance with subclauses (4) and (5).
- (3) To avoid doubt, the relief in subclause (1) applies only if an **ancillary service agent** is acting in its capacity as an **ancillary service agent** under an **ancillary service arrangement**.
- (4) As soon as practicable, but in any event no later than by the end of the month following the month in which the **ancillary service agent** advises the **system operator** of a **force majeure event** under subclause (2)(a), the **ancillary service agent** must provide the **Authority** with a written report that sets out—
 - (a) the full details of the **force majeure event**; and
 - (b) the actions the **ancillary service agent** is taking or intends to take to comply with subclause (2)(b); and
 - (c) the proposed timeline for completing the actions.
- (5) By the end of each following month (unless the **Authority** advises that reports may be provided less frequently or are not required) the **ancillary service agent** must provide the **Authority** with a written report that updates the information previously provided and includes any other matters related to the **force majeure event** that the **Authority** requests.
- (6) The **Authority** must **publish** the information provided under subclause (2)(a) and the reports provided under subclauses (4) and (5) as soon as practicable after receiving the information.

- (7) Despite subclause (6), the **Authority** must not **publish** or otherwise make available to the public any information or any part of a report if the **ancillary service agent** advises the **Authority** (with reasons) that the **ancillary service agent** considers that it would have good reason to refuse to supply the information or the part under clause 2.6 or clause 2.7.

Compare: SR 2003/374 r 53B

Clause 4.1: substituted, on 1 November 2012, by clause 8 of the Electricity Industry Participation (Force Majeure) Code Amendment 2012.

Clause 4.1(6): amended, on 5 October 2017, by clause 25(1) of the Electricity Industry Participation Code Amendment (Code Review Programme) 2017.

Clause 4.1(7): amended, on 5 October 2017, by clause 25(2) of the Electricity Industry Participation Code Amendment (Code Review Programme) 2017.

4.2 Effect of relief

If an **ancillary service agent** is relieved of an obligation under clause 4.1,—

- (a) the **ancillary service agent** is not liable for a breach of this Code or of the Electricity Industry (Enforcement) Regulations 2010 in respect of that obligation during the period for which the relief applies under that clause; and
- (b) any costs arising from the relief from the obligation lie where they fall, except that the **system operator** and the **ancillary service agent** may agree to adjust the remuneration of the **ancillary service agent**.

Compare: SR 2003/374 r 53C

Clause 4.2(a): amended, on 21 September 2012, by clause 5 of the Electricity Industry Participation (Minor Amendments) Code Amendment 2012.

Clause 4.2(a): amended, on 1 November 2012, by clause 9 of the Electricity Industry Participation (Force Majeure) Code Amendment 2012.

Electricity Industry Participation Code 2010

Part 5

Regime for dealing with undesirable trading situations

Contents

- 5.1 Occurrence of undesirable trading situation
 - 5.1A Time limit for investigating undesirable trading situation
 - 5.2 Actions Authority may take to correct undesirable trading situation
 - 5.3 Authority must consult with system operator
 - 5.4 Authority must consult with participants
 - 5.5 Authority must attempt to correct and restore normal operation as soon as possible
-

5.1 Occurrence of undesirable trading situation

- (1) If the **Authority** suspects or anticipates the development, or possible development, of an **undesirable trading situation**, the **Authority** may investigate the matter.
- (2) The following are examples of what the **Authority** may consider to constitute an **undesirable trading situation**:
 - (a) manipulative or attempted manipulative trading activity;
 - (b) conduct in relation to trading that is misleading or deceptive, or is likely to mislead or deceive;
 - (c) unwarranted speculation or an undesirable practice;
 - (d) material breach of any law;
 - (e) a situation that threatens orderly trading or proper settlement;
 - (f) any exceptional or unforeseen circumstance that is contrary to the public interest.
- (3) To avoid doubt,—
 - (a) the list of examples in subclause (2) is not an exhaustive list, and does not prevent the **Authority** from finding that an **undesirable trading situation** is developing or has developed in other circumstances; and
 - (b) an example listed in subclause (2) does not constitute an **undesirable trading situation** unless the example comes within the definition of that term in Part 1.

Compare: SR 2003/374 r 54

Clause 5.1(2) and (3): inserted, on 18 July 2013, by clause 5 of the Electricity Industry Participation (Undesirable Trading Situation) Code Amendment 2013.

5.1A Time limit for investigating undesirable trading situation

Despite clause 5.1(1), the **Authority** must not commence an investigation if more than 10 **business days** have passed since the situation, which the **Authority** suspects or anticipates may be an **undesirable trading situation**, occurred.

Clause 5.1A: inserted, on 18 July 2013, by clause 6 of the Electricity Industry Participation (Undesirable Trading Situation) Code Amendment 2013.

Clause 5.1A: amended, on 15 May 2014, by clause 5 of the Electricity Industry Participation (Minor Code Amendments) Code Amendment 2014.

5.2 Actions Authority may take to correct undesirable trading situation

- (1) If the **Authority** finds that an **undesirable trading situation** is developing or has developed, it may take any action that—
 - (a) the **Authority** considers is necessary to correct the **undesirable trading situation**; and
 - (b) relates to an aspect of the **electricity** industry that the **Authority** could regulate in this Code under section 32 of the **Act**.
- (2) The actions that the **Authority** may take under subclause (1) include any 1 or more of the following:
 - (a) directing that an activity be suspended, limited, or stopped, either generally or for a specified period:
 - (b) directing that completion of trades be deferred for a specified period:
 - (c) directing that any trades be closed out or settled at a specified price:
 - (d) directing a **participant** to take any actions that will, in the **Authority's** opinion, correct or assist in overcoming the **undesirable trading situation**.
- (2A) A direction given to a **participant** under subclause (2)(d)—
 - (a) may be inconsistent with this Code; but
 - (b) must not be inconsistent with the **Act**, or any other law.
- (3) The **participant** must comply promptly with a direction given to it in writing.
- (4) A **participant** is not liable to any other **participant** in relation to the taking of an action, or an omission, that is reasonably necessary for compliance with an **Authority** direction under this clause.
- (5) A **participant** does not breach this Code if it acts in accordance with a direction given under subclause (2)(d).

Compare: SR 2003/374 r 56

Clause 5.2(1): substituted, on 18 July 2013, by clause 7(1) of the Electricity Industry Participation (Undesirable Trading Situation) Code Amendment 2013.

Clause 5.2(2): substituted, on 18 July 2013, by clause 7(2) of the Electricity Industry Participation (Undesirable Trading Situation) Code Amendment 2013.

Clause 5.2(2A): inserted, on 18 July 2013, by clause 7(2) of the Electricity Industry Participation (Undesirable Trading Situation) Code Amendment 2013.

Clause 5.2(4): amended, on 18 July 2013, by clause 7(3) of the Electricity Industry Participation (Undesirable Trading Situation) Code Amendment 2013.

Clause 5.2(5): inserted, on 18 July 2013, by clause 7(4) of the Electricity Industry Participation (Undesirable Trading Situation) Code Amendment 2013.

5.3 Authority must consult with system operator

- (1) The **Authority** must consult with the **system operator** if—
 - (a) the **Authority** is considering taking an action under clause 5.2 to correct an **undesirable trading situation**; and
 - (b) it is possible that the action may have an effect on **system security**.
- (2) The **system operator** must maintain procedures that are necessary to enable it to respond immediately to the **Authority**, and provide information as soon as reasonably practicable, if the **Authority** consults the **system operator** under this clause.

Compare: SR 2003/374 r 58

5.4 Authority must consult with participants

If the **Authority** finds that an **undesirable trading situation** is developing or has developed, the **Authority** must—

- (a) immediately advise all **registered participants** of its findings and of any actions that the **Authority** intends to take, or has taken, to correct the **undesirable trading situation**; and
- (b) unless the **Authority** considers that it is impractical to do so, consult with affected **participants** before taking the action.

Compare: SR 2003/374 r 59

5.5 Authority must attempt to correct and restore normal operation as soon as possible

The **Authority** must attempt to correct every **undesirable trading situation** and, consistently with section 15 of the **Act**, restore the normal operation of the **wholesale market** as soon as possible.

Compare: SR 2003/374 r 60

Electricity Industry Participation Code 2010

Part 6 Connection of distributed generation

Contents

- 6.1 Contents of this Part
- 6.2 Purpose
- 6.2A Application of Part to distributors in respect of embedded networks
- 6.2B Application of Part to distributors in respect of systems of lines not directly or indirectly connected to grid
- 6.3 Distributors must make information publicly available
- 6.4 Process for obtaining approval
- 6.4A Distributor and distributed generator may agree to simpler process for existing connection
- 6.5 Connection contract
- 6.6 Connection on regulated terms
- 6.7 Extra terms
- 6.8 Dispute resolution
- 6.9 Pricing principles
- 6.10 *[Revoked]*
- 6.11 Distributors must act at arm's length
- 6.12 This Part does not affect rights and obligations under Code
Transitional provisions
- 6.13 This Part does not apply to earlier connections

Schedule 6.1

Process for obtaining approval

Preliminary provisions

Part 1

Applications for distributed generation 10 kW or less in total

Application process

Post-approval process

Part 1A

Part 2

Applications for distributed generation above 10 kW in total

Initial application process

Final application process

Post-approval process

Part 3

General provisions

Confidentiality

Annual reporting and record keeping

Costs

Schedule 6.2

Regulated terms for distributed generation

General

Meters

Access

Interruptions and disconnections

Confidentiality

Pricing

Liability

Schedule 6.3

Default dispute resolution process

Schedule 6.4

Pricing principles

Share of generation-driven costs

Repayment of previously funded investment

Non-firm connection service

Schedule 6.5

Prescribed maximum fees

6.1 Contents of this Part

This Part specifies—

- (a) a framework to enable the connection and continued connection of **distributed generation** if consistent with **connection and operation standards**; and
- (b) in Schedule 6.1, processes (including time frames) under which **distributed generators** may—
 - (i) connect **distributed generation**; or
 - (ii) continue an existing connection of **distributed generation** if the connection contract for the **distributed generation**—
 - (A) is in force and the **distributed generator** wishes to extend the term of the connection contract; or
 - (B) has expired; or
 - (iii) continue an existing connection of **distributed generation** that is connected without a connection contract if the **regulated terms** do not apply; or
 - (iv) change the **nameplate capacity** or fuel type of connected **distributed generation**; and
- (c) in Schedule 6.2, the **regulated terms** that apply to the connection of **distributed generation** in the absence of contractually agreed terms; and
- (d) in Schedule 6.3, a default dispute resolution process for disputes related to this Part; and
- (e) in Schedule 6.4, the pricing principles to be applied for the purposes of this Part; and
- (f) in Schedule 6.5, prescribed maximum fees.

Compare: SR 2007/219 r 4

Clause 6.1(a) and (b): substituted, on 23 February 2015, by clause 5 of the Electricity Industry Participation Code Amendment (Distributed Generation) 2014.

Clause 6.1(a): amended, on 5 October 2017, by clause 26(1) of the Electricity Industry Participation Code Amendment (Code Review Programme) 2017.

Clause 6.1(b): amended, on 5 October 2017, by clause 26(2) of the Electricity Industry Participation Code Amendment (Code Review Programme) 2017.

Clause 6.1(c): amended, on 23 February 2015, by clause 75 of the Electricity Industry Participation Code Amendment (Distributed Generation) 2014.

Clause 6.1(c): amended, on 5 October 2017, by clause 26(3) of the Electricity Industry Participation Code Amendment (Code Review Programme) 2017.

6.2 Purpose

The purpose of this Part is to enable **distributed generation** to be connected to a **distribution network** or to a **consumer installation** that is connected to a **distribution network**, if being connected is consistent with **connection and operation standards**.

Compare: SR 2007/219 r 3

Clause 6.2: amended, on 23 February 2015, by clauses 6 and 75 of the Electricity Industry Participation Code Amendment (Distributed Generation) 2014.

Clause 6.2: replaced, on 5 October 2017, by clause 27 of the Electricity Industry Participation Code Amendment (Code Review Programme) 2017.

6.2A Application of Part to distributors in respect of embedded networks

Nothing in this Part applies to—

- (a) a **distributor** in respect of the **distributor's** ownership or operation of an **embedded network** that conveys less than 5 GWh of **electricity** per annum; or
- (b) a **distributed generator** when the **distributed generator** wishes to connect or has **distributed generation** connected to such an **embedded network**.

Clause 6.2A: inserted, on 1 February 2016, by clause 7 of the Electricity Industry Participation Code Amendment (Code Review Programme) 2015.

Clause 6.2A(b): amended, on 5 October 2017, by clause 28 of the Electricity Industry Participation Code Amendment (Code Review Programme) 2017.

6.2B Application of Part to distributors in respect of systems of lines not directly or indirectly connected to grid

Nothing in this Part applies to—

- (a) a **distributor** in respect of the **distributor's** ownership or operation of a system of **lines** that is used for providing **line function services** only to the **distributor**; or
- (b) a **distributor** in respect of the **distributor's** ownership or operation of a system of **lines**—
 - (i) that conveys less than 5 GWh of **electricity** per annum; and
 - (ii) that is not—
 - (A) directly connected to the **grid**; or
 - (B) indirectly connected to the **grid** through 1 or more other **networks**; or
- (c) a **distributed generator** when the **distributed generator** wishes to connect or has **distributed generation** connected to a system of **lines** described in paragraph (b).

Heading: amended, on 5 October 2017, by clause 29(1) of the Electricity Industry Participation Code Amendment (Code Review Programme) 2017.

Clause 6.2B: inserted, on 1 February 2016, by clause 7 of the Electricity Industry Participation Code Amendment (Code Review Programme) 2015.

Clause 6.2B(b)(ii)(A) and (B): amended, on 5 October 2017, by clause 29(2) of the Electricity Industry Participation Code Amendment (Code Review Programme) 2017.

Clause 6.2B(c): amended, on 5 October 2017, by clause 29(2) of the Electricity Industry Participation Code Amendment (Code Review Programme) 2017.

6.3 Distributors must make information publicly available

- (1) The purpose of this clause is to require each **distributor** to make certain information publicly available to enable the approval of **distributed generation** under Schedule 6.1.
- (2) Each **distributor** must make publicly available, free of charge, from its office and Internet site,—
 - (a) forms for applications under Schedule 6.1; and
 - (b) the **distributor's connection and operation standards**; and
 - (c) a copy of the **regulated terms**, together with an explanation of how the **regulated terms** will apply if—
 - (i) approval is granted under Schedule 6.1; and
 - (ii) the **distributor** and the **distributed generator** do not enter into a connection contract; and
 - (d) a statement of the circumstances in which **distributed generation** will be, or may be, curtailed or interrupted from time to time in order to ensure that the **distributor's other connection and operation standards** are met; and
 - (da) a list of all locations on its **distribution network** that the **distributor** knows to be subject to **export congestion**; and
 - (db) a list of all locations on its **distribution network** that the **distributor** expects to become subject to **export congestion** within the next 12 months; and
 - (dc) until 1 September 2026, the **maximum export power** threshold and the methodology used to determine that threshold, for locations at which the **distributor** has set a **maximum export power** threshold for applications under Part 1A of Schedule 6.1; and
 - (e) a list of any fees that the **distributor** charges under Schedule 6.1, which must not exceed the relevant maximum fees prescribed in Schedule 6.5; and
 - (f) a list of the makes and models of inverters that the **distributor** has approved for connection to its **distribution network**; and
 - (g) the **distributor's** contact information for any enquiries relating to the connection of **distributed generation** to its **distribution network**.
- (3) The application forms referred to in subclause (2)(a) must specify the information, including any supporting documents, that must be provided with an application under Schedule 6.1.

Compare: SR 2007/219 r 6

Clause 6.3(1): substituted, on 23 February 2015, by clause 7(1) of the Electricity Industry Participation Code Amendment (Distributed Generation) 2014.

Clause 6.3(2)(a) – (c): substituted, on 23 February 2015, by clause 7(2) of the Electricity Industry Participation Code Amendment (Distributed Generation) 2014.

Clause 6.3(2)(c)(ii), (f) and (g): amended, on 5 October 2017, by clause 30(1) of the Electricity Industry Participation Code Amendment (Code Review Programme) 2017.

Clause 6.3(2)(d): amended, on 23 February 2015, by clause 7(3) of the Electricity Industry Participation Code Amendment (Distributed Generation) 2014.

Clause 6.3(2)(d): amended, on 5 October 2017, by clause 30(2) of the Electricity Industry Participation Code Amendment (Code Review Programme) 2017.

Clause 6.3(2)(da): inserted, on 23 February 2015, by clause 7(4) of the Electricity Industry Participation Code Amendment (Distributed Generation) 2014.

Clause 6.3(2)(da): replaced, on 20 December 2021, by clause 5(1) of the Electricity Industry Participation Code Amendment (Code Review Programme) 2019.

Clause 6.3(2)(db): inserted, on 20 December 2021, by clause 5(2) of the Electricity Industry Participation Code Amendment (Code Review Programme) 2019.

Clause 6.3(2)(dc): amended, on 20 December 2021, by clause 5(3) of the Electricity Industry Participation Code Amendment (Code Review Programme) 2019.

Clause 6.3(2)(e): substituted, on 23 February 2015, by clause 7(5) of the Electricity Industry Participation Code Amendment (Distributed Generation) 2014.

Clause 6.3(2)(f) and (g): inserted, on 23 February 2015, by clause 7(5) of the Electricity Industry Participation Code Amendment (Distributed Generation) 2014.

Clause 6.3(3): substituted, on 23 February 2015, by clause 7(6) of the Electricity Industry Participation Code Amendment (Distributed Generation) 2014.

Clause 6.3(2)(db): inserted, on 1 September 2021, by clause 5 of the Electricity Industry Participation Code Amendment (Application for Distributed Generation) 2021. **Note: paragraph 6.3(2)(dc) automatically revokes on the close of 1 September 2026 under clause 8 of the Electricity Industry Participation Code Amendment (Application for Distributed Generation) 2021.**

6.4 Process for obtaining approval

- (1) Schedule 6.1 applies if a **distributed generator** wishes to—
 - (a) connect **distributed generation**, whether on the **regulated terms** or on other terms; or
 - (b) continue an existing connection of **distributed generation** if the connection contract for the **distributed generation**—
 - (i) is in force and the **distributed generator** wishes to extend the term of the connection contract; or
 - (ii) has expired; or
 - (c) continue an existing connection of **distributed generation** that is connected without a connection contract if the **regulated terms** do not apply; or
 - (d) change the **nameplate capacity** or fuel type of connected **distributed generation**.
- (2) A **distributor** must approve an application submitted under Schedule 6.1 if the application complies with the requirements of that Schedule.
- (3) Except as provided in clause 6.4A, a **distributor** cannot contract out of the provisions of Schedule 6.1 with a **distributed generator**.

Compare: SR 2007/219 r 7

Clause 6.4: substituted, on 23 February 2015, by clause 8 of the Electricity Industry Participation Code Amendment (Distributed Generation) 2014.

Clause 6.4(1): amended, on 5 October 2017, by clause 31 of the Electricity Industry Participation Code Amendment (Code Review Programme) 2017.

6.4A Distributor and distributed generator may agree to simpler process for existing connection

A **distributor** and a **distributed generator** may agree a simpler process for the continued connection of **distributed generation** to the **distributor's distribution network** than the relevant process set out in Schedule 6.1 if—

- (a) a connection contract for the **distributed generation**—
 - (i) is in force and the **distributed generator** wishes to extend the term of the connection contract; or
 - (ii) has expired; or
- (b) the **distributed generation** is connected without a connection contract; or
- (c) there is a change in the **nameplate capacity** or fuel type of the **distributed generation**.

Clause 6.4A: inserted, on 23 February 2015, by clause 8 of the Electricity Industry Participation Code Amendment (Distributed Generation) 2014.

Clause 6.4A: amended, on 5 October 2017, by clause 32 of the Electricity Industry Participation Code Amendment (Code Review Programme) 2017.

6.5 Connection contract

If a **distributor** and a **distributed generator** enter into a contract for the connection of **distributed generation**,—

(a) their rights and obligations in respect of the connection of the **distributed generation** are governed by that contract, and accordingly the **regulated terms** do not apply; and

(b) a breach of the terms of that contract is not a breach of this Code.

Compare: SR 2007/219 r 8

Heading: amended, on 23 February 2015, by clause 9 of the Electricity Industry Participation Code Amendment (Distributed Generation) 2014.

Clause 6.5: amended, on 23 February 2015, by clauses 9 and 75 of the Electricity Industry Participation Code Amendment (Distributed Generation) 2014.

Clause 6.5: amended, on 5 October 2017, by clause 33 of the Electricity Industry Participation Code Amendment (Code Review Programme) 2017.

6.6 Connection on regulated terms

(1) Schedule 6.2 sets out the **regulated terms** for the connection of **distributed generation**.

(2) The **regulated terms** apply in the following circumstances:

(a) if a **distributor** and a **distributed generator** do not enter into a connection contract by the expiry of the period for negotiating a connection contract under clauses 9 or 24 of Schedule 6.1:

(b) in accordance with clause 9G of Schedule 6.1.

(3) If the **regulated terms** apply,—

(a) the parties' rights and obligations in respect of the connection of the **distributed generation** are governed by the **regulated terms**; and

(b) a breach of the **regulated terms** is not a breach of contract.

(4) Despite this clause, a **distributor** and a **distributed generator** may at any time, by agreement, enter into a connection contract that will apply instead of the **regulated terms**.

Compare: SR 2007/219 r 9

Clause 6.6: amended, on 5 October 2017, by clause 34 of the Electricity Industry Participation Code Amendment (Code Review Programme) 2017.

Clause 6.6(1): amended, on 23 February 2015, by clause 75 of the Electricity Industry Participation Code Amendment (Distributed Generation) 2014.

Clause 6.6(2) and (4): substituted, on 23 February 2015, by clause 10 of the Electricity Industry Participation Code Amendment (Distributed Generation) 2014.

Clause 6.6(3): amended, on 23 February 2015, by clause 75 of the Electricity Industry Participation Code Amendment (Distributed Generation) 2014.

6.7 Extra terms

(1) The parties' rights and obligations in respect of a connection on the **regulated terms** are also governed by any other terms and conditions that—

(a) were made publicly available under clause 6.3(2)(d) in a statement of the terms and conditions that would apply to **distributed generation** if there is congestion on the **distribution network**; or

(b) cover any other incidental matters (for example, invoicing procedures) if—

(i) the matters are not covered by the **regulated terms**; and

(ii) the other matters are reasonable terms and conditions that either were proposed by the **distributor** during the 30 **business day** negotiation period as part of a connection contract or are terms that would be implied by law if the connection was under a connection contract; and

(iii) the other terms and conditions do not contradict any of the **regulated terms**.

- (2) In this Part, if the parties have agreed to change all or any part of 1 or more of the **regulated terms** as part of a binding contract, the resulting contract is, in total, a connection contract on terms that apply instead of the **regulated terms** for the purposes of this Part.

Compare: SR 2007/219 r 10

Clause 6.7: amended, on 23 February 2015, by clauses 11 and 75 of the Electricity Industry Participation Code Amendment (Distributed Generation) 2014.

Clause 6.7: amended, on 5 October 2017, by clause 35 of the Electricity Industry Participation Code Amendment (Code Review Programme) 2017.

6.8 Dispute resolution

- (1) Subject to subclause (2), Schedule 6.3 applies to a dispute between a **distributed generator** that is a **participant** and a **distributor** arising from any one of the following

- (a) an allegation that a party has breached any of the **regulated terms** that apply under clause 6.6(2); and
- (aa) an allegation that conditions specified by the **distributor** under clause 18 of Schedule 6.1 are not reasonably required; and
- (ab) an allegation that a party has not attempted to negotiate in good faith under clause 6 or clause 21 of Schedule 6.1; and
- (b) an allegation that a party has breached any of the other provisions of this Part.

- (2) However, Schedule 6.3 does not apply to disputes between a **distributed generator** and a **distributor**—

- (a) arising from an allegation that a party has breached any of the terms of a connection contract; or
- (b) arising from an allegation that a party has breached any of the extra terms referred to in clause 6.7(1); or
- (c) that the **distributed generator** and the **distributor** have agreed should be determined by any other agreed method (for example, under any dispute resolution scheme under section 95 of the **Act**).

Compare: SR 2007/219 r 11

Clause 6.8: amended, on 5 October 2017, by clause 36 of the Electricity Industry Participation Code Amendment (Code Review Programme) 2017.

Clause 6.8(1) and (1)(a): amended, on 23 February 2015, by clause 12(1) and (2) of the Electricity Industry Participation Code Amendment (Distributed Generation) 2014.

Clause 6.8(1)(aa) and (ab): inserted, on 23 February 2015, by clause 12(3) of the Electricity Industry Participation Code Amendment (Distributed Generation) 2014.

Clause 6.8(1)(b): substituted, on 23 February 2015, by clause 12(4) of the Electricity Industry Participation Code Amendment (Distributed Generation) 2014.

Clause 6.8(2)(a): amended, on 23 February 2015, by clauses 12(5) and 75 of the Electricity Industry Participation Code Amendment (Distributed Generation) 2014.

6.9 Pricing principles

Schedule 6.4 applies in accordance with—

- (a) clause 19 of Schedule 6.2; and
- (b) clause 4 of Schedule 6.3.

Compare: SR 2007/219 r 12

Clause 6.9(a): amended, on 23 February 2015, by clause 13 of the Electricity Industry Participation Code Amendment (Distributed Generation) 2014.

6.10 [Revoked]

Compare: SR 2007/219 r 13

Clause 6.10: revoked, on 23 February 2015, by clause 14 of the Electricity Industry Participation Code Amendment (Distributed Generation) 2014.

6.11 Distributors must act at arm's length

A **distributor** must use, in respect of all **distributed generators**, the same reasonable efforts in processing and considering applications and notices under Schedule 6.1, regardless of—

- (a) whether the **distributor** has an ownership interest or a beneficial interest in the **distributed generator**; or
- (b) who the **distributed generator** is.

Compare: SR 2007/219 r 14

Heading: amended, on 23 February 2015, by clause 15(1) of the Electricity Industry Participation Code Amendment (Distributed Generation) 2014.

Clause 6.11 and 6.11(a): amended, on 23 February 2015, by clause 15(2) of the Electricity Industry Participation Code Amendment (Distributed Generation) 2014.

Clause 6.11(b): substituted, on 23 February 2015, by clause 15(3) of the Electricity Industry Participation Code Amendment (Distributed Generation) 2014.

6.12 This Part does not affect rights and obligations under Code

This Part does not affect any rights or obligations of a **distributor** or a **distributed generator** under any other clause in this Code.

Compare: SR 2007/219 r 15

Transitional provisions

6.13 This Part does not apply to earlier connections

This Part does not apply in relation to, or affect, any **distributed generation** that was connected under a contract entered into before 30 August 2007, except for the purpose of renewing or extending the term of the contract.

Compare: SR 2007/219 r 17

Clause 6.13: substituted, on 23 February 2015, by clause 16 of the Electricity Industry Participation Code Amendment (Distributed Generation) 2014.

Clause 6.13: amended, on 5 October 2017, by clause 37 of the Electricity Industry Participation Code Amendment (Code Review Programme) 2017.

Schedule 6.1 Process for obtaining approval

cl 6.4

Heading: amended, on 23 February 2015, by clause 17 of the Electricity Industry Participation Code Amendment (Distributed Generation) 2014.

Contents

Preliminary provisions

- 1A Contents of this Schedule
- 1B Distributed generator must apply
- 1C How Parts apply to applications
- 1D When application may be made under Part 1A

Part 1

Applications for distributed generation 10 kW or less in total

- 1 Contents of this Part

Application process

- 2 Applications under this Part of this Schedule
- 3 Distributor's decision on application
- 4 Extension of time by mutual agreement for distributor to process application
- 5 Distributed generator must give notice of intention to negotiate

Post-approval process

- 6 30 business days to negotiate connection contract if distributed generator gives notice of intention to proceed
- 7 Testing and inspection
- 8 Connection of distributed generation if connection contract negotiated
- 9 Connection of distributed generation on regulated terms if connection contract not negotiated

Part 1A

Applications for distributed generation of 10 kW or less in total in specified circumstances

- 9A Contents of this Part
- 9B Application for distributed generation of 10 kW or less in total in specified circumstances
- 9C Distributor may inspect distributed generation
- 9D Export congestion
- 9E Non-compliance or incomplete information
- 9F Notice of final approval
- 9G Regulated terms apply
- 9H When distributed generator may connect to distribution network

Part 2

Applications for distributed generation above 10 kW in total

- 10 Contents of this Part

Initial application process

- 11 Distributed generator must make initial application and give information
- 12 Distributor must give information to distributed generator

- 13 Other matters to assist with decision making
14 Distributor and distributed generator must make reasonable endeavours regarding new information

Final application process

- 15 Distributed generator must make final application
16 Notice to third parties
17 Priority of final applications
18 Distributor's decision on application
19 Time within which distributor must decide final applications
20 Distributed generator must give notice of intention to negotiate

Post-approval process

- 21 30 business days to negotiate connection contract if distributed generator gives notice of intention to negotiate
22 Testing and inspection
23 Connection of distributed generation if connection contract negotiated
24 Connection of distributed generation on regulated terms if connection contract not negotiated

Part 3

General provisions

Confidentiality

- 25 Confidentiality of information provided

Annual reporting and record keeping

- 26 *[Revoked]*
27 *[Revoked]*
28 Distributors must keep records

Costs

- 29 Responsibility for costs under this Schedule
-

Preliminary provisions

1A Contents of this Schedule

This Schedule specifies the procedures for processing applications from **distributed generators** for the connection or continued connection of **distributed generation**.

Clause 1A: amended, on 5 October 2017, by clause 38 of the Electricity Industry Participation Code Amendment (Code Review Programme) 2017.

1B Distributed generator must apply

Subject to clause 6.4A and clause 1D, a **distributed generator** that owns or operates **distributed generation** must apply to a **distributor** if it wishes to—

- (a) connect the **distributed generation** to the **distributor's distribution network**; or
(b) continue an existing connection of the **distributed generation** to the **distributor's distribution network** if a connection contract for the **distributed generation**—
(i) is in force and the **distributed generator** wishes to extend the term of the connection contract; or

- (ii) has expired; or
- (c) continue an existing connection of the **distributed generation** to the **distributor's distribution network** that is connected without a connection contract if the **regulated terms** do not apply; or
- (d) change the **nameplate capacity** or fuel type of the **distributed generation** connected to the **distributor's distribution network**.

Clause 1B: amended, on 5 October 2017, by clause 39 of the Electricity Industry Participation Code Amendment (Code Review Programme) 2017.

1C How Parts apply to applications

This Schedule applies to applications made under clause 1B as follows:

- (a) Part 1 applies to applications in respect of **distributed generation** that has a **nameplate capacity** of 10 kW or less in total, unless the **distributed generator** has elected, under clause 1D, to apply under Part 1A:
- (b) Part 1A applies to applications in respect of **distributed generation** that has a **nameplate capacity** of 10 kW or less in total, if the **distributed generator** has elected, under clause 1D, to apply under Part 1A:
- (c) Part 2 applies to applications in respect of **distributed generation** that has a **nameplate capacity** of more than 10 kW in total.

1D When application may be made under Part 1A

- (1) A **distributed generator** may elect to apply to a **distributor** under Part 1A instead of Part 1 if the **distributed generation** to which the application relates—
 - (a) is designed and installed in accordance with AS/NZS 4777.1:2016; and
 - (b) incorporates an inverter that—
 - (i) has been tested and issued a Declaration of Conformity with AS/NZS 4777.2:2020 by a laboratory with accreditation issued or recognised by International Accreditation New Zealand; and
 - (ii) has settings that meet the **distributor's connection and operation standards**.
- (2) Until 1 September 2026, a **distributed generator** may only elect to apply to a **distributor** under Part 1A instead of Part 1, if the **distributed generation** to which the application relates has, in addition to the requirements in subclause (1)—
 - (a) a volt-watt response mode;
 - (b) a volt-var response mode;
 - (c) control settings and volt response mode settings that meet the **distributor's connection and operation standards**; and
 - (d) a **maximum export power** limit at the **ICP** of the **distributed generator** that does not exceed the **maximum export power** threshold, if any, specified by the **distributor** in its **connection and operation standards**.

Cross heading and clauses 1A to 1D: inserted, on 23 February 2015, by clause 18 of the Electricity Industry Participation Code Amendment (Distributed Generation) 2014.

Clause 1D(b): amended, on 20 October 2016, by clause 4 of the Electricity Industry Participation Code Amendment (Inverter Standard for Distributed Generation) 2016.

Clause 1D: replaced, on 1 September 2021, by clause 6(1) of the Electricity Industry Participation Code Amendment (Application for Distributed Generation) 2021.

Clause 1D(2): inserted, on 1 September 2021, by clause 6(2) of the Electricity Industry Participation Code Amendment (Application for Distributed Generation) 2021. **Note: paragraph 1D(2) automatically revokes on the close of 1 September 2026 under clause 8 of the Electricity Industry Participation Code Amendment (Application for Distributed Generation) 2021.**

Clause 1D(1)(b)(i): amended, on 18 December 2021, by clause 4 of the Electricity Industry Participation Code Amendment (Inverter Standard for Distributed Generation) 2021.

Part 1
Applications for distributed generation
10 kW or less in total

Heading: amended, on 23 February 2015, by clause 19 of the Electricity Industry Participation Code Amendment (Distributed Generation) 2014.

1 Contents of this Part

- (1) This Part applies to applications relating to **distributed generation** that has a **nameplate capacity** of 10 kW or less in total, unless the **distributed generator** that owns or operates the **distributed generation** has elected, under clause 1D, to apply under Part 1A.
- (2) This Part of this Schedule provides for a 1-stage application process.
Compare: SR 2007/219 clause 1 Schedule 1
Clause 1(1): substituted, on 23 February 2015, by clause 20 of the Electricity Industry Participation Code Amendment (Distributed Generation) 2014.

Application process

2 Applications under this Part of this Schedule

- (1) *[Revoked]*
- (2) A **distributed generator** must apply to a **distributor** by—
- (a) using the application form provided by the **distributor** that is publicly available under clause 6.3(2)(a); and
 - (b) providing any information in respect of the **distributed generation** to which the application relates that is—
 - (i) referred to in subclause (3); and
 - (ii) specified by the **distributor** under clause 6.3(3) as being required to be provided with the application; and
 - (c) paying the application fee (if any) specified by the **distributor** in accordance with clause 6.3(2)(e).
- (3) The information may include the following:
- (a) the full name and address of the **distributed generator** and the contact details of a person that the **distributor** may contact regarding the **distributed generation**:
 - (aa) whether the application is to—
 - (i) connect **distributed generation**; or
 - (ii) continue an existing connection of **distributed generation** that is connected in accordance with a connection contract if the connection contract—
 - (A) is in force and the **distributed generator** wishes to extend the term of the connection contract; or
 - (B) has expired; or
 - (iii) continue an existing connection of **distributed generation** that is connected without a connection contract; or
 - (iv) change the **nameplate capacity** or fuel type of connected **distributed generation**:
 - (b) evidence of the **nameplate capacity** that the **distributed generation** will have, or other suitable evidence that the **distributed generation** is or will only be capable of generating **electricity** at a rate of 10 kW or less:

- (ba) if the application is to change the **nameplate capacity** or fuel type of connected **distributed generation**—
 - (i) the **nameplate capacity** that the **distributed generation** will have after the change; and
 - (ii) the aggregate **nameplate capacity** that all **distributed generation** that is connected at the **point of connection** at which the **distributed generation** is connected will have after the change; and
 - (iii) the fuel type that the **distributed generation** will have after the change:
- (c) details of the fuel type of the **distributed generation** (for example, solar, wind, or liquid fuel):
- (d) a brief description of the physical location at the address at which the **distributed generation** is or will be connected:
- (da) if the application is to connect **distributed generation**, when the **distributed generator** expects the **distributed generation** to be connected:
- (e) technical specifications of the **distributed generation** and **associated equipment**, including the following:
 - (i) technical specifications of equipment that allows the **distributed generation** to be **electrically disconnected** from the **distribution network** on loss of mains voltage:
 - (ii) manufacturer's rating of equipment:
 - (iii) number of phases:
 - (iv) proposed or current **point of connection** to the **distribution network** (for example, the **ICP identifier** and street address):
 - (v) details of either or both of any inverter and battery storage:
 - (vi) details of any load at the proposed or current **point of connection**:
 - (vii) details of the voltage (for example, 415 V or 11 kV) when it is **electrically connected**:
- (f) information showing how the **distributed generation** complies with the **distributor's connection and operation standards**:
- (g) any additional information or documents that are reasonably required by the **distributor**.

(4) *[Revoked]*

- (5) The **distributor** must, within 5 **business days** of receiving an application, give written notice to the applicant advising whether or not the application is complete.

Compare: SR 2007/219 clause 2 Schedule 1

Heading: amended, on 23 February 2015, by clause 21(1) of the Electricity Industry Participation Code Amendment (Distributed Generation) 2014.

Clause 2: amended, on 5 October 2017, by clause 40(1) of the Electricity Industry Participation Code Amendment (Code Review Programme) 2017.

Clause 2(1): revoked, on 23 February 2015, by clause 21(2) of the Electricity Industry Participation Code Amendment (Distributed Generation) 2014.

Clause 2(2): substituted, on 23 February 2015, by clause 21(3) of the Electricity Industry Participation Code Amendment (Distributed Generation) 2014.

Clause 2(3)(a): amended, on 23 February 2015, by clause 21(4) of the Electricity Industry Participation Code Amendment (Distributed Generation) 2014.

Clause 2(3)(aa): inserted, on 23 February 2015, by clause 21(5) of the Electricity Industry Participation Code Amendment (Distributed Generation) 2014.

Clause 2(3)(aa): amended, on 5 October 2017, by clause 40(3) of the Electricity Industry Participation Code Amendment (Code Review Programme) 2017.

Clause 2(3)(aa), (3)(ba) and 3(d): amended, on 5 October 2017, by clause 40(2) of the Electricity Industry Participation Code Amendment (Code Review Programme) 2017.

Clause 2(3)(b): substituted, on 23 February 2015, by clause 21(6) of the Electricity Industry Participation Code Amendment (Distributed Generation) 2014.

Clause 2(3)(ba): inserted, on 23 February 2015, by clause 21(7) of the Electricity Industry Participation Code Amendment (Distributed Generation) 2014.

Clause 2(3)(ba)(ii): amended, on 23 February 2015, by clause 6(1) of the Electricity Industry Participation Code Amendment (Minor Code Amendments) (No 3) 2014.

Clause 2(3)(ba)(iii): inserted, on 23 February 2015, by clause 6(2) of the Electricity Industry Participation Code Amendment (Minor Code Amendments) (No 3) 2014.

Clause 2(3)(c) and(d): substituted, on 23 February 2015, by clause 21(8) of the Electricity Industry Participation Code Amendment (Distributed Generation) 2014.

Clause 2(3)(da): inserted, on 23 February 2015, by clause 21(9) of the Electricity Industry Participation Code Amendment (Distributed Generation) 2014.

Clause 2(3)(da): amended, on 5 October 2017, by clause 40(4) of the Electricity Industry Participation Code Amendment (Code Review Programme) 2017.

Clause 2(3)(e): substituted, on 23 February 2015, by clause 21(10) of the Electricity Industry Participation Code Amendment (Distributed Generation) 2014.

Clause 2(3)(e)(i): amended, on 5 October 2017, by clause 40(5) of the Electricity Industry Participation Code Amendment (Code Review Programme) 2017.

Clause 2(3)(e)(vii): amended, on 5 October 2017, by clause 40(6) of the Electricity Industry Participation Code Amendment (Code Review Programme) 2017.

Clause 2(3)(g): amended, on 23 February 2015, by clause 21(11) of the Electricity Industry Participation Code Amendment (Distributed Generation) 2014.

Clause 2(4): revoked, on 23 February 2015, by clause 21(12) of the Electricity Industry Participation Code Amendment (Distributed Generation) 2014.

3 Distributor's decision on application

- (1) A **distributor** must, within 30 **business days** after the date of receipt of a completed application made in accordance with clause 2, give notice in writing to the applicant stating whether the application is approved or declined.
- (2) A **distributor** must approve an application if—
 - (a) the application has been properly made in accordance with Part 6 of this Code; and
 - (b) the information provided in the application would reasonably support an assessment by the **distributor** that—
 - (i) the **distributed generator** will comply at all times with the requirements of the Health and Safety at Work Act 2015; and
 - (ii) the **distributed generator** will ensure that the **distributed generation** complies at all times with the **Act**, and this Code; and
 - (iii) the **distributed generation** meets the **distributor's connection and operation standards**.
- (3) A notice stating that an application is declined must be accompanied by the following information:
 - (a) detailed reasons of why the application has been declined and the steps that the applicant can take to achieve approval if it makes a new application;
 - (b) information about the default process under Schedule 6.3 for the resolution of disputes between **participants** about an alleged breach of the **regulated terms** or any other provision of Part 6 of this Code;
 - (c) that if the **distributed generator** is not a **participant**, the **distributed generator** may report to the **Authority** under the Electricity Industry (Enforcement) Regulations 2010 if it considers that the **distributor** has breached any requirement in Part 6 of this Code.

Compare: SR 2007/219 clause 3 Schedule 1

Clause 3(2): amended, on 23 February 2015, by clause 22(1) of the Electricity Industry Participation Code Amendment (Distributed Generation) 2014.

Clause 3(2)(b)(i): amended, on 5 October 2017, by clause 41 of the Electricity Industry Participation Code Amendment (Code Review Programme) 2017.

Clause 3(2)(b)(ii) and (iii): substituted, on 23 February 2015, by clause 22(2) of the Electricity Industry Participation Code Amendment (Distributed Generation) 2014.

Clause 3(3)(a) and (b): amended, on 23 February 2015, by clause 22(3) and (4) of the Electricity Industry Participation Code Amendment (Distributed Generation) 2014.

Clause 3(3)(c): inserted, on 23 February 2015, by clause 22(5) of the Electricity Industry Participation Code Amendment (Distributed Generation) 2014.

4 Extension of time by mutual agreement for distributor to process application

- (1) A **distributor** may seek an extension of the time specified in clause 3(1) by which the **distributor** must give notice in writing stating whether an application is approved or declined.
- (2) The **distributor** must do this by notice in writing to the **distributed generator** specifying the reasons for the extension.
- (3) The **distributed generator** that made the application—
 - (a) may grant an extension which must not exceed **20 business days**; and
 - (b) must not unreasonably withhold consent to an extension.

Compare: SR 2007/219 clause 4 Schedule 1

Clause 4(1): amended, on 23 February 2015, by clause 23(1) of the Electricity Industry Participation Code Amendment (Distributed Generation) 2014.

Clause 4(3): substituted, on 23 February 2015, by clause 23(2) of the Electricity Industry Participation Code Amendment (Distributed Generation) 2014.

5 Distributed generator must give notice of intention to negotiate

- (1) If a **distributor** advises a **distributed generator** that its application is approved, the **distributed generator** must give written notice to the **distributor** confirming whether the **distributed generator** intends to negotiate a connection contract under clause 6 and, if so, confirming the details of the **distributed generation** to which the application relates.
- (2) The **distributed generator** must give the notice within **10 business days** after the **distributor** gives notice of approval, or such later date as is agreed by the **distributor** and the **distributed generator**.
- (3) The **distributor's** duties under Part 6 of this Code arising from the application no longer apply if the **distributed generator** fails to give notice to the **distributor** within the time limit specified in subclause (2).
- (4) Subclause (3) does not prevent the **distributed generator** from making a new application under Part 6 of this Code.

Compare: SR 2007/219 clause 5 Schedule 1

Heading: amended, on 5 October 2017, by clause 42(1) of the Electricity Industry Participation Code Amendment (Code Review Programme) 2017.

Clause 5(1): substituted, on 23 February 2015, by clause 24(1) of the Electricity Industry Participation Code Amendment (Distributed Generation) 2014.

Clause 5(1): amended, on 5 October 2017, by clause 42(2) of the Electricity Industry Participation Code Amendment (Code Review Programme) 2017. Clause 5(2): amended, on 23 February 2015, by clause 24(2) of the Electricity Industry Participation Code Amendment (Distributed Generation) 2014.

Clause 5(3) and (4): amended, on 23 February 2015, by clause 24(3) and (4) of the Electricity Industry Participation Code Amendment (Distributed Generation) 2014.

Post-approval process

Cross heading: amended, on 23 February 2015, by clause 25 of the Electricity Industry Participation Code Amendment (Distributed Generation) 2014.

6 30 business days to negotiate connection contract if distributed generator gives notice of intention to proceed

- (1) If a **distributed generator** whose application under clause 2 is approved gives notice to a **distributor** under clause 5, the **distributor** and the **distributed generator** have 30 **business days**, starting on the date on which the **distributor** receives the notice, during which they must, in good faith, attempt to negotiate a connection contract.
- (2) The **distributor** and the **distributed generator** may, by agreement, extend the time specified in subclause (1) for negotiating a connection contract.

Compare: SR 2007/219 clause 6 Schedule 1

Clause 6 heading: amended, on 1 November 2018, by clause 6 of the Electricity Industry Participation Code Amendment (Code Review Programme) 2018.

Clause 6: amended, on 23 February 2015, by clauses 26 and 75 of the Electricity Industry Participation Code Amendment (Distributed Generation) 2014.

Clause 6: amended, on 5 October 2017, by clause 43 of the Electricity Industry Participation Code Amendment (Code Review Programme) 2017.

7 Testing and inspection

- (1) Subject to subclause (1A), a **distributed generator** whose application under clause 2 is approved by a **distributor** must test and inspect the **distributed generation** to which the application relates within a reasonable time frame specified by the **distributor**.
- (1A) The **distributor** may waive the requirement that the **distributed generator** test and inspect if the **distributor** is satisfied that the **distributed generation** complies with the **distributor's connection and operation standards**.
- (2) The **distributed generator** must give adequate notice of the testing and inspection to the **distributor**.
- (3) The **distributor** may send qualified personnel to the site to observe the testing and inspection.
- (4) The **distributed generator** must give the **distributor** with a written test report when testing and inspection is complete, including suitable evidence that the **distributed generation** complies with the **distributor's connection and operation standards**.
- (5) The **distributed generator** must pay any fee specified by the **distributor** in accordance with clause 6.3(2)(e) for observing the testing and inspection.

Compare: SR 2007/219 clause 7 Schedule 1

Clause 7(1): substituted, on 23 February 2015, by clause 27(1) of the Electricity Industry Participation Code Amendment (Distributed Generation) 2014.

Clause 7(1A): inserted, on 23 February 2015, by clause 27(2) of the Electricity Industry Participation Code Amendment (Distributed Generation) 2014.

Clause 7(4) and (5): amended, on 23 February 2015, by clause 27(3) and (4) of the Electricity Industry Participation Code Amendment (Distributed Generation) 2014.

8 Connection of distributed generation if connection contract negotiated

- (1) This clause applies if a **distributor** and a **distributed generator** whose application under this Part of this Schedule is approved enter into a connection contract before the period for negotiating a connection contract under this Part of this Schedule expires.

- (2) If the application is to connect **distributed generation** under clause 1B(a), the **distributor** must allow the **distributed generator** to connect the **distributed generation** in accordance with the contract as soon as practicable.
- (3) If the application is to continue an existing connection of **distributed generation** under clause 1B(b), the **distributor** must use its best endeavours to ensure that the new terms under which the **distributed generator's** existing connection continues apply—
 - (a) as soon as practicable, if the previous connection contract has expired; or
 - (b) no later than the expiry of the previous connection contract, if the contract is in force.
- (4) If the application is to continue an existing connection for which there is no connection contract under clause 1B(c), the **distributor** must use its best endeavours to ensure that the new terms under which the **distributed generator's** existing connection continues apply as soon as practicable.
- (5) If the application is to change the **nameplate capacity** or fuel type of connected **distributed generation** under clause 1B(d), the **distributor** must use its best endeavours to ensure that the new terms under which the **distributed generator's** existing connection continues apply as soon as practicable.

Compare: SR 2007/219 clause 8 Schedule 1

Clause 8: substituted, on 23 February 2015, by clause 28 of the Electricity Industry Participation Code Amendment (Distributed Generation) 2014.

Clause 8: amended, on 5 October 2017, by clause 44 of the Electricity Industry Participation Code Amendment (Code Review Programme) 2017.

9 Connection of distributed generation on regulated terms if connection contract not negotiated

- (1) This clause applies if a **distributor** and a **distributed generator** whose application under this Part of this Schedule is approved do not enter into a connection contract before the period for negotiating a connection contract under this Part of this Schedule expires.
- (2) If the application is to connect **distributed generation** under clause 1B(a), the **distributor** must allow the **distributed generator** to connect the **distributed generation** on the **regulated terms** as soon as practicable after the expiry of the period.
- (3) If the application is to continue an existing connection of **distributed generation** under clause 1B(b), the **regulated terms** apply to the **distributed generator's** existing connection as follows:
 - (a) if the previous connection contract has expired, the **regulated terms** apply from the day after the date on which the period for negotiating a connection contract under this Part of this Schedule expires;
 - (b) if the previous connection contract is still in force, the **regulated terms** apply from the day after the date on which the contract expired.
- (4) If the application is to continue an existing connection for which there is no connection contract under clause 1B(c), the **regulated terms** apply from the day after the date that the period for negotiating a connection contract under this Part of this Schedule expires.
- (5) If the application is to change the **nameplate capacity** or fuel type of connected **distributed generation** under clause 1B(d), the **regulated terms** apply from the day after the date that the period for negotiating a connection contract under this Part of this Schedule expires.

Compare: SR 2007/219 clause 9 Schedule 1

Clause 9: substituted, on 23 February 2015, by clause 28 of the Electricity Industry Participation Code Amendment (Distributed Generation) 2014.

Clause 9: amended, on 5 October 2017, by clause 45(1) of the Electricity Industry Participation Code Amendment (Code Review Programme) 2017.
Clause 9(2): amended, on 5 October 2017, by clause 45(2) of the Electricity Industry Participation Code Amendment (Code Review Programme) 2017.
Clause 9(5): amended, on 5 October 2017, by clause 45(3) of the Electricity Industry Participation Code Amendment (Code Review Programme) 2017.

Part 1A

Applications for distributed generation of 10 kW or less in total in specified circumstances

9A Contents of this Part

- (1) This Part applies to applications relating to **distributed generation** that has a **nameplate capacity** of 10 kW or less in total if the **distributed generator** that owns or operates the **distributed generation** has elected, under clause 1D, to apply under this Part of this Schedule.
- (2) This Part of this Schedule provides for a simplified 1-stage application process.

9B Application for distributed generation of 10 kW or less in total in specified circumstances

- (1) A **distributed generator's** application to a **distributor** must specify which of the following circumstances applies:
 - (a) the **distributed generator** wishes to connect **distributed generation**:
 - (b) the **distributed generator** wishes to continue an existing connection of **distributed generation** that is connected in accordance with a connection contract that—
 - (i) is in force and the **distributed generator** wishes to extend the term of the connection contract; or
 - (ii) has expired:
 - (c) the **distributed generator** wishes to continue an existing connection of **distributed generation** that is connected without a connection contract:
 - (d) the **distributed generator** wishes to change the **nameplate capacity** or fuel type of connected **distributed generation**.
- (2) An application must include the following:
 - (a) the name, contact, and address details of the **distributed generator** and, if applicable, the **distributed generator's** agent:
 - (b) a brief description of the physical location at the address at which the **distributed generation** is or will be connected:
 - (c) any application fee specified by the **distributor** in accordance with clause 6.3(2)(e):
 - (d) details of the make and model of the inverter:
 - (e) confirmation as to whether the inverter—
 - (i) is included on the **distributor's** list of approved inverters made publicly available under clause 6.3(2)(f); or
 - (ii) conforms with the settings specified in the **distributor's connection and operation standards**:
 - (f) if the inverter is not included on the **distributor's** list of approved inverters, a copy of the AS/NZS 4777.2:2020 Declaration of Conformity certificate for the inverter:
 - (g) details of—

- (i) the **nameplate capacity** of the **distributed generation**; and
 - (ii) the fuel type of the **distributed generation** (for example, solar, wind, or liquid fuel).
- (2A) Until 1 September 2026, an application must also include—
- (a) confirmation as to whether the inverter conforms with the control settings and volt response mode settings specified in the **distributor’s connection and operation standards**;
 - (b) confirmation that the **distributed generation** has a **maximum export power** limit that does not exceed the **maximum export power** threshold, if any, specified by the **distributor** in its **connection and operation standards**; and
 - (c) the **maximum export power** of the **distributed generation**.
- (3) The **distributed generator** must also give the **distributor** the following information as soon as it is available, but no later than 10 **business days** after the approval of the application:
- (a) a copy of the Certificate of Compliance issued under the Electricity (Safety) Regulations 2010 that relates to the **distributed generation**;
 - (b) the **ICP identifier** of the **ICP** at which the **distributed generation** is connected or is proposed to be connected, if one exists.
- (4) A **distributor** must, no later than 2 **business days** after receiving an application from a **distributed generator**, acknowledge receipt of the application.

Clause 9B: amended, on 5 October 2017, by clause 46(3) of the Electricity Industry Participation Code Amendment (Code Review Programme) 2017.

Clause 9B(1)(a): amended, on 5 October 2017, by clause 46(1) of the Electricity Industry Participation Code Amendment (Code Review Programme) 2017.

Clause 9B(1): amended, on 5 October 2017, by clause 46(2) of the Electricity Industry Participation Code Amendment (Code Review Programme) 2017.

Clause 9B(2)(e)(ii): amended, on 1 September 2021, by clause 7(1) of the Electricity Industry Participation Code Amendment (Application for Distributed Generation) 2021.

Clause 9B(2)(f): amended, on 20 October 2016, by clause 5 of the Electricity Industry Participation Code Amendment (Inverter Standard for Distributed Generation) 2016.

Clause 9B(2)(f): amended, on 1 September 2021, by clause 7(2) of the Electricity Industry Participation Code Amendment (Application for Distributed Generation) 2021.

Clause 9B(2)(f): amended, on 18 December 2021, by clause 5 of the Electricity Industry Participation Code Amendment (Inverter Standard for Distributed Generation) 2021

Clause 9B(2A): inserted, on 1 September 2021, by clause 7(3) of the Electricity Industry Participation Code Amendment (Application for Distributed Generation) 2021. **Note: paragraph 9B(2A) automatically revokes on the close of 1 September 2026 under clause 8 of the Electricity Industry Participation Code Amendment (Application for Distributed Generation) 2021.**

9C Distributor may inspect distributed generation

- (1) A **distributor** may inspect **distributed generation** that is connected or is proposed to be connected to its **distribution network** for the purpose of—
- (a) verifying that the **distributed generation** meets, or continues to meet, the requirements specified in clause 1D; or
 - (b) verifying the information contained in an application made under this Part of this Schedule.
- (2) If a **distributor** wishes to inspect **distributed generation**, the **distributor** must give the **distributed generator** at least 2 **business days’** notice of the time and date on which the inspection will take place.
- (3) Following receipt of a notice, the **distributed generator** must—
- (a) pay the fee specified by the **distributor** in accordance with clause 6.3(2)(e) for the inspection (if any); and

(b) provide or arrange for the **distributor** to have reasonable access to the **distributed generation**.

Clause 9C(1): amended, on 5 October 2017, by clause 47 of the Electricity Industry Participation Code Amendment (Code Review Programme) 2017.

9D Export congestion

(1) This clause applies if a **distributed generator** applies to a **distributor** under this Part of this Schedule to connect **distributed generation** or continue an existing connection of **distributed generation** to a location on the **distributor's distribution network** that is included in the list made publicly available in accordance with clause 6.3(2)(da) or (db).

(2) The **distributor** may advise the **distributed generator** that the **distributed generation** may be subject to **export congestion** as set out in the **distributor's congestion management policy**.

(3) If a **distributor** has advised a **distributed generator** under subclause (2), the **distributor** must take reasonable steps to work with the **distributed generator** to assess whether solutions exist to mitigate the **export congestion**.

Clause 9D(1): amended, on 5 October 2017, by clause 48 of the Electricity Industry Participation Code Amendment (Code Review Programme) 2017.

Clause 9D(1): amended, on 20 December 2021, by clause 6 of the Electricity Industry Participation Code Amendment (Code Review Programme) 2019.

9E Non-compliance or incomplete information

(1) This clause applies if a **distributor** considers that an application made to it by a **distributed generator** under this Part of this Schedule has 1 or more of the following deficiencies:

(a) the **distributed generation** to which the application relates does not meet the requirements specified in clause 1D:

(b) the **distributed generation** to which the application relates is not as described in the information given under clause 9B(2):

(c) the **distributed generator** has not complied with clause 9B(2).

(2) If this clause applies, the **distributor** must advise the **distributed generator** of the deficiency or deficiencies.

(3) If the **distributed generator** is advised of a deficiency or deficiencies, it must remedy each deficiency to the satisfaction of the **distributor** no later than 10 **business days** after being advised of the deficiency.

(4) If the **distributed generator** is required to remedy a deficiency it must pay the relevant fee specified by the **distributor** in accordance with clause 6.3(2)(e).

(5) If the **distributed generator** does not remedy each deficiency of which it is advised within the time frame specified in subclause (3)—

(a) if the **distributed generation** to which the application relates is **electrically connected** to the **distributor's distribution network** at the time the **distributor** advises the **distributed generator** under subclause (2), the **distributor** may, by notice to the **distributed generator**, require the **distributed generator** to—

(i) **electrically disconnect** the **distributed generation** within a reasonable time frame specified by the **distributor** (if applicable); and

(ii) keep the **distributed generation electrically disconnected** until each deficiency is remedied to the **distributor's** satisfaction; or

- (b) if the **distributed generation** is not connected to the **distributor's distribution network** at the time of being advised under subclause (2), the **distributor** may, by notice to the **distributed generator**, prohibit the **distributed generator** from connecting the **distributed generation** to the **distributor's distribution network** until each deficiency is remedied to the **distributor's** satisfaction.
- (6) The **distributor** must approve connection of the **distributed generation** as soon as is reasonable in the circumstances if—
- (a) the **distributed generator** complies with a notice given under subclause (5)(a) (if applicable); and
- (b) the **distributed generator** remedies each deficiency advised under subclause (2)—
- (i) to the satisfaction of the **distributor**; and
- (ii) no later than 12 months after the date of the notice given under subclause (5) or such later date as is agreed by the **distributor** and the **distributed generator**.
- (7) If the **distributor** approves the connection of **distributed generation**, it must give a notice of final approval to the **distributed generator** under clause 9F.
- Clause 9E(5)(a): replaced, on 5 October 2017, by clause 49(1) of the Electricity Industry Participation Code Amendment (Code Review Programme) 2017.
- Clause 9E(5)(b): amended, on 5 October 2017, by clause 49(2) of the Electricity Industry Participation Code Amendment (Code Review Programme) 2017.
- Clause 9E(6): amended, on 5 October 2017, by clause 49(3) of the Electricity Industry Participation Code Amendment (Code Review Programme) 2017.
- Clause 9E(7): amended, on 5 October 2017, by clause 49(4) of the Electricity Industry Participation Code Amendment (Code Review Programme) 2017.

9F Notice of final approval

- (1) A **distributor** must give a notice of final approval of **distributed generation** to a **distributed generator** that has made an application to the **distributor** under this Part of this Schedule if the **distributor** is satisfied that—
- (a) the **distributed generation** meets the requirements specified in clause 1D; and
- (b) the information given by the **distributed generator** under clause 9B(2) is complete and accurate.
- (2) The **distributor** must give the notice no later than 10 **business days** after the date on which the application was submitted.
- (3) If the **distributed generator** does not receive a notice by the date specified in subclause (2), the **distributor** is deemed to have given notice of final approval.

9G Regulated terms apply

- (1) If a **distributor** gives a notice of final approval to a **distributed generator** under clause 9F, the **regulated terms** apply.
- (2) Despite subclause (1), and in accordance with clause 6.6(4), the **distributor** and **distributed generator** may at any time enter into a connection contract on terms that apply instead of the **regulated terms**.
- Clause 9G(2): amended, on 5 October 2017, by clause 50 of the Electricity Industry Participation Code Amendment (Code Review Programme) 2017.

9H When distributed generator may connect to distribution network

- (1) A **distributed generator** that has submitted an application to a **distributor** under clause 1D may connect the **distributed generation** to which the application relates to the **distributor's distribution network** if the **distributed generator** receives a notice

of final approval under clause 9F(1), or is deemed to have received a notice of final approval under clause 9F(3).

- (2) Despite subclause (1) a **distributor** may prohibit a **distributed generator** from connecting if—
- (a) the **distributor** has advised the **distributed generator** of a deficiency under clause 9E(2) and the deficiency has not been remedied in accordance with clause 9E(3); or
 - (b) the **distributor** gave notice that it wished to inspect the **distributed generation** under clause 9C(2), but the **distributed generator** has not provided or arranged for the **distributor** to have reasonable access to the **distributed generation** under clause 9C(3)(b).

Part 1A: inserted, on 23 February 2015, by clause 29 of the Electricity Industry Participation Code Amendment (Distributed Generation) 2014.

Clause 9H(1) and (2): amended, on 5 October 2017, by clause 51 of the Electricity Industry Participation Code Amendment (Code Review Programme) 2017.

Part 2

Applications for distributed generation above 10 kW in total

Heading: amended, on 23 February 2015, by clause 30 of the Electricity Industry Participation Code Amendment (Distributed Generation) 2014.

10 Contents of this Part

- (1) This Part of this Schedule applies to applications relating to **distributed generation** that has a **nameplate capacity** of more than 10 kW in total.
- (2) This Part of this Schedule provides for a 2-stage application process.

Compare: SR 2007/219 clause 10 Schedule 1

Clause 10(1): substituted, on 23 February 2015, by clause 31 of the Electricity Industry Participation Code Amendment (Distributed Generation) 2014.

Initial application process

11 Distributed generator must make initial application and give information

- (1) *[Revoked]*
- (2) A **distributed generator** must apply to a **distributor** ("**initial application**") by—
- (a) using the application form provided by the **distributor** that is publicly available under clause 6.3(2)(a); and
 - (b) providing any information in respect of the **distributed generation** to which the application relates that is—
 - (i) referred to in subclause (3); and
 - (ii) specified by the **distributor** under clause 6.3(3) as being required to be provided with the application; and
 - (c) paying the application fee (if any) specified by the **distributor** in accordance with clause 6.3(2)(e).
- (3) The information may include the following:
- (a) the full name and address of the **distributed generator** and the contact details of a person whom the **distributor** may contact regarding the **distributed generation**:
 - (aa) whether the application is to—

- (i) connect **distributed generation**; or
 - (ii) continue an existing connection of **distributed generation** that is connected in accordance with a connection contract if the connection contract—
 - (A) is in force and the **distributed generator** wishes to extend the term of the connection contract; or
 - (B) has expired; or
 - (iii) continue an existing connection of **distributed generation** that is connected without a connection contract; or
 - (iv) change the **nameplate capacity** or fuel type of connected **distributed generation**:
- (b) evidence of the **nameplate capacity** that the **distributed generation** will have:
- (ba) if the application is to change the **nameplate capacity** or fuel type of connected **distributed generation**,—
- (i) the **nameplate capacity** that the **distributed generation** will have after the change; and
 - (ii) the aggregate **nameplate capacity** that all **distributed generation** that is connected at the **point of connection** at which the **distributed generation** is connected will have after the change; and
 - (iii) the fuel type that the **distributed generation** will have after the change:
- (c) details of the fuel type of the **distributed generation** (for example, solar, wind, or liquid fuel):
- (d) a brief description of the physical location at the address at which the **distributed generation** is or will be connected:
- (da) if the application is to **connect distributed generation**, when the **distributed generator** expects the **distributed generation** to be connected:
- (e) technical specifications of the **distributed generation** and **associated equipment**, including the following:
- (i) technical specifications of equipment that allows the **distributed generation** to be **electrically disconnected** from the **distribution network** on loss of mains voltage:
 - (ii) manufacturer's rating of equipment:
 - (iii) number of phases:
 - (iv) proposed or current **point of connection** to the **distribution network** (for example, the **ICP identifier** and street address):
 - (v) details of either or both of any inverter and battery storage:
 - (vi) details of any load at the proposed or current **point of connection**:
 - (vii) details of the voltage (for example, 415 V or 11 kV) when **electrically connected**:
- (f) information showing how the **distributed generation** complies with the **distributor's connection and operation standards**:
- (g) the maximum **active power** injected (**MW max**):
- (h) the **reactive power** requirements (**MVAr**s) (if any):
- (i) resistance and reactance details of the **distributed generation**:
- (j) fault level contribution (**kA**):
- (k) method of voltage control:
- (l) single line diagram of proposed connection:

- (m) means of **synchronising** with, **electrically connecting** to, and **electrically disconnecting** from, the **distribution network**, including the type and ratings of the proposed **circuit breaker**:
 - (n) details of compliance with frequency and voltage support requirements as specified in this Code (if applicable):
 - (o) proposed periods and amounts of **electricity injections** into, and **offtakes** from, the **distribution network** (if known):
 - (p) any other information that is required by the **system operator**:
 - (q) any additional information or **documents** that are reasonably required by the **distributor**.
- (4) *[Revoked]*
- (5) The **distributor** must, within **5 business days** of receiving an **initial application**, give written notice to the applicant advising whether or not the application is complete.
- Compare: SR 2007/219 clause 11 Schedule 1
Heading: amended, on 23 February 2015, by clause 32(1) of the Electricity Industry Participation Code Amendment (Distributed Generation) 2014.
Clause 11: amended, on 5 October 2017, by clause 52(1) of the Electricity Industry Participation Code Amendment (Code Review Programme) 2017.
Clause 11(1): revoked, on 23 February 2015, by clause 32(2) of the Electricity Industry Participation Code Amendment (Distributed Generation) 2014.
Clause 11(2): substituted, on 23 February 2015, by clause 32(3) of the Electricity Industry Participation Code Amendment (Distributed Generation) 2014.
Clause 11(3)(a): amended, on 23 February 2015, by clause 32(4) of the Electricity Industry Participation Code Amendment (Distributed Generation) 2014.
Clause 11(3)(aa): inserted, on 23 February 2015, by clause 32(5) of the Electricity Industry Participation Code Amendment (Distributed Generation) 2014.
Clause 11(3)(aa): amended, on 5 October 2017, by clause 52(2) of the Electricity Industry Participation Code Amendment (Code Review Programme) 2017.
Clause 11(3)(aa), (ba) and (d): amended, on 5 October 2017, by clause 52(3) of the Electricity Industry Participation Code Amendment (Code Review Programme) 2017.
Clause 11(3)(b): substituted, on 23 February 2015, by clause 32(6) of the Electricity Industry Participation Code Amendment (Distributed Generation) 2014.
Clause 11(3)(ba): inserted, on 23 February 2015, by clause 32(7) of the Electricity Industry Participation Code Amendment (Distributed Generation) 2014.
Clause 2(3)(ba)(ii): amended, on 23 February 2015, by clause 7(1) of the Electricity Industry Participation Code Amendment (Minor Code Amendments) (No 3) 2014.
Clause 2(3)(ba)(iii): inserted, on 23 February 2015, by clause 7(2) of the Electricity Industry Participation Code Amendment (Minor Code Amendments) (No 3) 2014.
Clause 11(3)(c) and (d): substituted, on 23 February 2015, by clause 32(8) of the Electricity Industry Participation Code Amendment (Distributed Generation) 2014.
Clause 11(3)(da): inserted, on 23 February 2015, by clause 32(9) of the Electricity Industry Participation Code Amendment (Distributed Generation) 2014.
Clause 11(3)(da): amended, on 5 October 2017, by clause 52(4) of the Electricity Industry Participation Code Amendment (Code Review Programme) 2017.
Clause 11(3)(e): substituted, on 23 February 2015, by clause 32(10) of the Electricity Industry Participation Code Amendment (Distributed Generation) 2014.
Clause 11(3)(e)(i): amended, on 5 October 2017, by clause 52(5) of the Electricity Industry Participation Code Amendment (Code Review Programme) 2017.
Clause 11(3)(e)(vii): amended, on 5 October 2017, by clause 52(6) of the Electricity Industry Participation Code Amendment (Code Review Programme) 2017.
Clause 11(3)(i): amended, on 23 February 2015, by clause 32(11) of the Electricity Industry Participation Code Amendment (Distributed Generation) 2014.
Clause 11(3)(l): amended, on 23 February 2015, by clause 75 of the Electricity Industry Participation Code Amendment (Distributed Generation) 2014.
Clause 11(3)(l): amended, on 5 October 2017, by clause 52(7) of the Electricity Industry Participation Code Amendment (Code Review Programme) 2017.
Clause 11(3)(m): amended, on 23 February 2015, by clauses 32(12) and 75 of the Electricity Industry Participation Code Amendment (Distributed Generation) 2014.

Clause 11(3)(m): replaced, on 5 October 2017, by clause 52(8) of the Electricity Industry Participation Code Amendment (Code Review Programme) 2017.

Clause 11(3)(q): amended, on 23 February 2015, by clause 32(13) of the Electricity Industry Participation Code Amendment (Distributed Generation) 2014.

Clause 11(4): revoked, on 23 February 2015, by clause 32(14) of the Electricity Industry Participation Code Amendment (Distributed Generation) 2014.

12 Distributor must give information to distributed generator

A **distributor** must give a **distributed generator** that makes an **initial application** the following within 30 **business days** of receiving the completed **initial application**:

- (a) information about the **capacity** of the **distribution network**, including both the design **capacity** (including fault levels) and actual operating levels:
- (b) information about the extent to which connection and operation of the **distributed generation** may result in a breach of the relevant standards for safety, voltage, power quality, and reliability of **electricity** conveyed to **points of connection** on the **distribution network**:
- (c) information about any measures or conditions (including modifications to the design and operation of the **distribution network** or to the operation of the **distributed generation**) that may be necessary to address the matters referred to in paragraphs (a) and (b):
- (d) the approximate costs of any **distribution network** related measures or conditions identified under paragraph (c) and an estimate of time constraints or restrictions that may delay connecting the **distributed generation**:
- (e) information about any further detailed investigative studies that the **distributor** reasonably considers are necessary to identify any potential adverse effects the **distributed generation** may have on the system, together with an indication of—
 - (i) whether the **distributor** agrees to the **distributed generator**, or a suitably qualified agent of the **distributed generator**, undertaking those studies; or
 - (ii) if not, whether the **distributor** could undertake those studies and, if so, the reasonable estimated cost of the studies that the **distributed generator** would be charged:
- (f) information about any obligations to other parties that may be imposed on the **distributor** and that could affect the **distributed generation** (for example, obligations to **Transpower**, in respect of other **networks**, or under this Code):
- (g) any additional information or documents that the **distributor** considers would assist the **distributed generator's** application:
- (h) information about the extent to which planned and **unplanned outages** may adversely affect the operation of the **distributed generation**.

Compare: SR 2007/219 clause 12 Schedule 1

Heading: amended, on 23 February 2015, by clause 33(1) of the Electricity Industry Participation Code Amendment (Distributed Generation) 2014.

Clause 12: amended, on 23 February 2015, by clause 33(2) of the Electricity Industry Participation Code Amendment (Distributed Generation) 2014.

Clause 12(b): amended, on 23 February 2015, by clauses 33(3) and 75 of the Electricity Industry Participation Code Amendment (Distributed Generation) 2014.

Clause 12(b): amended, on 5 October 2017, by clause 53(1) of the Electricity Industry Participation Code Amendment (Code Review Programme) 2017.

Clause 12(d): amended, on 23 February 2015, by clauses 33(4) and 75 of the Electricity Industry Participation Code Amendment (Distributed Generation) 2014.

Clause 12(d): amended, on 5 October 2017, by clause 53(2) of the Electricity Industry Participation Code Amendment (Code Review Programme) 2017.

Clause 12(e): amended, on 23 February 2015, by clause 33(5) of the Electricity Industry Participation Code Amendment (Distributed Generation) 2014.

13 Other matters to assist with decision making

- (1) A **distributor** must provide, if requested by a **distributed generator** making an **initial application**, further information that is reasonably necessary to enable the **distributed generator** to consider and act on the information given by the **distributor** under clause 12.
- (2) The information that the **distributor** must provide under subclause (1) may include single line diagrams, equipment ratings, normal switch configurations (including fault levels), and protection system details relevant to the current or proposed **point of connection** of the **distributed generation** to the **distribution network**.
- (3) The **distributor** must provide the further information under this clause within 10 **business days** of the request being received.

Compare: SR 2007/219 clause 13 Schedule 1

Clause 13(2): amended, on 23 February 2015, by clause 34 of the Electricity Industry Participation Code Amendment (Distributed Generation) 2014.

14 Distributor and distributed generator must make reasonable endeavours regarding new information

If a **distributor** or a **distributed generator** has given information under this Part of this Schedule and subsequently becomes aware of new information that is relevant to the application, the party that becomes aware of the new information must use reasonable endeavours to provide the other party with the new information.

Compare: SR 2007/219 clause 14 Schedule 1

Clause 14: amended, on 23 February 2015, by clause 35 of the Electricity Industry Participation Code Amendment (Distributed Generation) 2014.

Final application process

15 Distributed generator must make final application

- (1) A **distributed generator** that makes an **initial application** to a **distributor** must make a **final application**, no later than 12 months after receiving information under clauses 12 and 13, if the **distributed generator** wishes to proceed with the application, unless—
 - (a) the **distributor** and the **distributed generator** agree that a **final application** is not required; and
 - (b) there are no persons to whom the **distributor** must give written notice under clause 16 at the time that the **distributor** and **distributed generator** agree that a **final application** is not required.
- (1A) If a **final application** is not required—
 - (a) subclause (2) does not apply; and
 - (b) the **distributed generator's initial application** must be treated as a **final application** for the purposes of clauses 16 to 24.
- (2) The **distributed generator** must make the **final application** by—

- (a) using the **final application** form provided by the **distributor** that is publicly available under clause 6.3(2)(a); and
- (b) providing the results of any investigative studies that were identified by the **distributor** under clause 12(e)(i) as to be undertaken by the **distributed generator** or the **distributed generator's agent**.

Compare: SR 2007/219 clause 15 Schedule 1

Clause 15(1): substituted, on 23 February 2015, by clause 36(1) of the Electricity Industry Participation Code Amendment (Distributed Generation) 2014.

Clause 15(1)(b): amended, on 1 November 2018, by clause 7 of the Electricity Industry Participation Code Amendment (Code Review Programme) 2018. Clause 15(1A): inserted, on 23 February 2015, by clause 36(2) of the Electricity Industry Participation Code Amendment (Distributed Generation) 2014.

16 Notice to third parties

A **distributor** that receives a **final application** must give written notice to the following persons no later than 10 **business days** after receiving the **final application**:

- (a) all persons that have made an **initial application** relating to a particular part of the **distribution network** that the **distributor** considers would be affected by the approval of the **final application**; and
- (b) all **distributed generators** that have **distributed generation** with a **nameplate capacity** of 10 kW or more in total connected on the **regulated terms** to the particular part of the **distribution network** that the **distributor** considers would be affected by the approval of the **final application**.

Compare: SR 2007/219 clause 16 Schedule 1

Clause 16: substituted, on 23 February 2015, by clause 37 of the Electricity Industry Participation Code Amendment (Distributed Generation) 2014.

Clause 16(b): amended, on 5 October 2017, by clause 54 of the Electricity Industry Participation Code Amendment (Code Review Programme) 2017.

17 Priority of final applications

- (1) Subclause (2) applies if—
 - (a) a **distributor** receives a **final application** (the **first application**); and
 - (b) the **distributor** receives another **final application**, within 20 **business days** after receiving the **first application**, relating to a particular part of the **distribution network** that the **distributor** considers would be affected by the approval of the **first application**.
- (2) If this subclause applies, the **distributor**—
 - (a) may consider the **final applications** together as if they were competitive bids to use the same part of the **distribution network**; and
 - (b) must consider the **final applications** in light of the purpose of Part 6 of this Code.
- (3) In any other case in which a **distributor** receives more than 1 **final application** relating to a similar part of the **distribution network**, the **distributor** must consider an earlier **final application** in priority to other **final applications**.
- (4) Subclause (3) does not limit clause 19.

Compare: SR 2007/219 clause 17 Schedule 1

Clause 17(1) and (2): substituted, on 23 February 2015, by clause 38(1) of the Electricity Industry Participation Code Amendment (Distributed Generation) 2014.

Clause 17(3): amended, on 23 February 2015, by clause 38(2) of the Electricity Industry Participation Code Amendment (Distributed Generation) 2014.

18 Distributor's decision on application

- (1) A **distributor** must, within the time limit specified in clause 19, give notice in writing to the applicant stating whether the **final application** is approved or declined.
- (2) A **distributor** must approve a **final application**, subject to any conditions specified by the **distributor** that are reasonably required, if—
 - (a) the application has been properly made in accordance with Part 6 of this Code; and
 - (b) the information provided in the application would reasonably support an assessment by the **distributor** that—
 - (i) the **distributed generator** will comply at all times with the requirements of the Health and Safety at Work Act 2015; and
 - (ii) the **distributed generator** will ensure that the **distributed generation** complies at all times with the **Act** and this Code; and
 - (iii) the **distributed generation** meets the **distributor's connection and operation standards** (assuming that the **distributed generator** meets the conditions (if any) referred to in subclause (3)).
- (3) A notice stating that an application is approved must be accompanied by the following information:
 - (a) a detailed description of any conditions (or other measures) that are conditions of the approval under subclause (2), and what the **distributed generator** must do to comply with them;
 - (b) detailed reasons for those conditions (or other measures):
 - (c) a detailed description of any charges payable by the **distributed generator** to the **distributor** or by the **distributor** to the **distributed generator**, and an explanation of how the charges have been, or will be, calculated;
 - (d) the default process for resolving disputes under Schedule 6.3, if the **distributed generator** disputes all or any of the conditions (or other measures) or charges payable.
- (4) A notice stating that an application is declined must be accompanied by the following information:
 - (a) detailed reasons as to why the application has been declined and what the applicant must do to get approval if it makes a new application:
 - (aa) if the application is one to which clause 17(2) applies, the criteria used in making a decision under clause 17(2)(a) and clause 17(2)(b):
 - (b) the default process for resolving disputes between **participants** under Schedule 6.3:
 - (c) that if the **distributed generator** is not a **participant**, the **distributed generator** may report to the **Authority** under the Electricity Industry (Enforcement) Regulations 2010 if it considers that the **distributor** has breached any requirement in Part 6 of this Code.

Compare: SR 2007/219 clause 18 Schedule 1

Clause 18(2): amended, on 23 February 2015, by clause 39(1) of the Electricity Industry Participation Code Amendment (Distributed Generation) 2014.

Clause 18(2)(b)(i): amended, on 5 October 2017, by clause 55 of the Electricity Industry Participation Code Amendment (Code Review Programme) 2017.

Clause 18(3): substituted, on 23 February 2015, by clause 39(2) of the Electricity Industry Participation Code Amendment (Distributed Generation) 2014.

Clause 18(4)(a): substituted, on 23 February 2015, by clause 39(3) of the Electricity Industry Participation Code Amendment (Distributed Generation) 2014.

Clause 18(4)(aa): inserted, on 23 February 2015, by clause 39(4) of the Electricity Industry Participation Code Amendment (Distributed Generation) 2014.

Clause 18(4)(b): substituted, on 23 February 2015, by clause 39(5) of the Electricity Industry Participation Code Amendment (Distributed Generation) 2014.

Clause 18(4)(c): inserted, on 23 February 2015, by clause 39(5) of the Electricity Industry Participation Code Amendment (Distributed Generation) 2014.

19 Time within which distributor must decide final applications

- (1) A notice required by clause 18 must be given by a **distributor** to a **distributed generator** no later than—
 - (a) **45 business days** after the date of receipt of the **final application**, in the case of **distributed generation** that will have a **nameplate capacity** of less than **1 MW**; or
 - (b) **60 business days** after the date of receipt of the **final application**, in the case of **distributed generation** that will have a **nameplate capacity** of **1 MW** or more but less than **5 MW**; or
 - (c) **80 business days** after the date of receipt of the **final application**, in the case of **distributed generation** that will have a **nameplate capacity** of **5 MW** or more.
- (2) The **distributor** may seek 1 or more extensions of the time specified in subclause (1).
- (3) The **distributor** must do this by notice in writing to the **distributed generator** specifying the reasons for the extension.
- (4) A **distributed generator** that receives a notice seeking an extension—
 - (a) may grant an extension which must not exceed **40 business days**; and
 - (b) must not unreasonably withhold consent to an extension.

Compare: SR 2007/219 clause 19 Schedule 1

Clause 19(1): substituted, on 23 February 2015, by clause 40(1) of the Electricity Industry Participation Code Amendment (Distributed Generation) 2014.

Clause 19(4): substituted, on 23 February 2015, by clause 40(2) of the Electricity Industry Participation Code Amendment (Distributed Generation) 2014.

20 Distributed generator must give notice of intention to negotiate

- (1) If a **distributor** advises a **distributed generator** that the **distributed generator's final application** is approved, the **distributed generator** must give written notice to the **distributor** confirming whether or not the **distributed generator** intends to proceed to negotiate a connection contract under clause 21(1) and, if so, confirming—
 - (a) the details of the **distributed generation**; and
 - (b) that the **distributed generator** accepts all of the conditions (or other measures) that have been specified by the **distributor** under clause 18.
- (2) The **distributed generator** must give the notice no later than **30 business days** after the day on which the **distributor** gives notice of approval under clause 18, or such later date as is agreed by the **distributor** and the **distributed generator**.
- (3) If the **distributed generator** is a **participant** and does not accept 1 or more of the conditions specified by the **distributor** under clause 18(2) (if any), but intends to proceed to negotiate a connection contract under clause 21(1), the **distributed generator** must—
 - (a) give notice of the dispute in accordance with clause 2 of Schedule 6.3 within **30 business days** after the day on which the **distributor** gives notice of approval under clause 18; and

- (b) give a notice under subclause (1) within 30 **business days** after the dispute is resolved.
- (4) The **distributor's** duties under Part 6 of this Code arising from the application no longer apply if the **distributed generator** fails to give notice to the **distributor** of an intention to proceed to negotiate a connection contract under clause 21(1) within the time limits specified in this clause.
- (5) Subclause (4) does not prevent the **distributed generator** from making a new application under Part 6 of this Code.
- Compare: SR 2007/219 clause 20 Schedule 1
Clause 20 heading: amended, on 20 December 2021, by clause 7 of the Electricity Industry Participation Code Amendment (Code Review Programme) 2019.
Clause 20: substituted, on 23 February 2015, by clause 41 of the Electricity Industry Participation Code Amendment (Distributed Generation) 2014.
Clause 20: amended, on 5 October 2017, by clause 56 of the Electricity Industry Participation Code Amendment (Code Review Programme) 2017.

Post-approval process

Cross heading: amended, on 23 February 2015, by clause 42 of the Electricity Industry Participation Code Amendment (Distributed Generation) 2014.

21 30 business days to negotiate connection contract if distributed generator gives notice of intention to negotiate

- (1) If a **distributed generator** whose **final application** is approved gives notice to a **distributor** under clause 20(1), the **distributor** and the **distributed generator** have 30 **business days**, starting on the date on which the **distributor** receives the notice, during which they must, in good faith, attempt to negotiate a connection contract.
- (2) The **distributor** and the **distributed generator** may, by agreement, extend the time specified in subclause (1) for negotiating a connection contract.
- Compare: SR 2007/219 clause 21 Schedule 1
Clause 21 heading: amended, on 20 December 2021, by clause 8 of the Electricity Industry Participation Code Amendment (Code Review Programme) 2019.
Clause 21 heading: amended, on 1 November 2018, by clause 8 of the Electricity Industry Participation Code Amendment (Code Review Programme) 2018.
Clause 21: amended, on 23 February 2015, by clauses 43 and 75 of the Electricity Industry Participation Code Amendment (Distributed Generation) 2014.
Clause 21: amended, on 5 October 2017, by clause 57 of the Electricity Industry Participation Code Amendment (Code Review Programme) 2017.

22 Testing and inspection

- (1) A **distributed generator** whose **final application** is approved by a **distributor** must test and inspect the **distributed generation** to which the **final application** relates within a reasonable time frame specified by the **distributor**.
- (1A) The **distributor** may waive the requirement that the **distributed generator** test and inspect if the **distributor** is satisfied that the **distributed generation** complies with the **distributor's connection and operation standards**.
- (2) The **distributed generator** must give adequate notice of the testing and inspection to the **distributor**.
- (3) The **distributor** may send qualified personnel to the site to observe the testing and inspection.

- (4) The **distributed generator** must give the **distributor** with a written test report when testing and inspection is complete, including suitable evidence that the **distributed generation** complies with the **distributor's connection and operation standards**.
- (5) The **distributed generator** must pay any fee specified by the **distributor** in accordance with clause 6.3(2)(e) for observing the testing and inspection.

Compare: SR 2007/219 clause 22 Schedule 1

Clause 22(1): substituted, on 23 February 2015, by clause 44(1) of the Electricity Industry Participation Code Amendment (Distributed Generation) 2014.

Clause 22(1A): inserted, on 23 February 2015, by clause 44(2) of the Electricity Industry Participation Code Amendment (Distributed Generation) 2014.

Clause 22(4): amended, on 23 February 2015, by clause 44(3) of the Electricity Industry Participation Code Amendment (Distributed Generation) 2014.

Clause 22(5): amended, on 23 February 2015, by clause 44(4) of the Electricity Industry Participation Code Amendment (Distributed Generation) 2014.

23 Connection of distributed generation if connection contract negotiated

- (1) This clause applies if a **distributor** and a **distributed generator** whose **final application** is approved enter into a connection contract before the period for negotiating a connection contract under this Part of this Schedule expires.
- (2) If the application is to connect **distributed generation** under clause 1B(a), the **distributor** must allow the **distributed generator** to connect the **distributed generation** in accordance with the contract as soon as practicable.
- (3) If the application is to continue an existing connection of **distributed generation** under clause 1B(b), the **distributor** must use its best endeavours to ensure that the new terms under which the **distributed generator's** existing connection continues apply—
 - (a) as soon as practicable, if the previous connection contract has expired; or
 - (b) no later than the expiry of the previous connection contract, if the contract is in force.
- (4) If the application is to continue an existing connection for which there is no connection contract under clause 1B(c), the **distributor** must use its best endeavours to ensure that the new terms under which the **distributed generator's** existing connection continues apply as soon as practicable.
- (5) If the application is to change the **nameplate capacity** or fuel type of connected **distributed generation** under clause 1B(d), the **distributor** must use its best endeavours to ensure that the new terms under which the **distributed generator's** existing connection continues apply as soon as practicable.

Compare: SR 2007/219 clause 23 Schedule 1

Clause 23: substituted, on 23 February 2015, by clause 45 of the Electricity Industry Participation Code Amendment (Distributed Generation) 2014.

Clause 23: amended, on 5 October 2017, by clause 58(1) of the Electricity Industry Participation Code Amendment (Code Review Programme) 2017.

Clause 23(2): amended, on 5 October 2017, by clause 58(2) of the Electricity Industry Participation Code Amendment (Code Review Programme) 2017.

Clause 23(5): amended, on 5 October 2017, by clause 58(3) of the Electricity Industry Participation Code Amendment (Code Review Programme) 2017.

24 Connection of distributed generation on regulated terms if connection contract not negotiated

- (1) This clause applies if a **distributor** and a **distributed generator** whose **final application** is approved do not enter into a connection contract before the period for negotiating a connection contract under this Part of this Schedule expires.

- (2) If the application is to connect **distributed generation** under clause 1B(a), the **distributor** must allow the **distributed generator** to connect the **distributed generation** on the **regulated terms** as soon as practicable after the later of the following:
- (a) the expiry of the period for negotiating a connection contract under this Part of this Schedule:
 - (b) the date on which the **distributed generator** has fully complied with any conditions (or other measures) that were specified by the **distributor** under clause 18 as conditions of the connection.
- (3) If the application is to continue an existing connection of **distributed generation** under clause 1B(b), the **regulated terms** apply to the **distributed generator's** existing connection from the later of the following:
- (a) the expiry of the period for negotiating a connection contract under this Part of this Schedule:
 - (b) the expiry of the existing connection contract:
 - (c) the date on which the **distributed generator** has fully complied with any conditions (or other measures) that were specified by the **distributor** under clause 18 as conditions of the connection.
- (4) If the application is to continue an existing connection for which there is no connection contract under clause 1B(c), the **regulated terms** apply from the later of the following:
- (a) the expiry of the period for negotiating a connection contract under this Part of this Schedule:
 - (b) the date on which the **distributed generator** has fully complied with any conditions (or other measures) that were specified by the **distributor** under clause 18 as conditions of the connection.
- (5) If the application is to change the **nameplate capacity** or fuel type of connected **distributed generation** under clause 1B(d), the **regulated terms** apply from the later of the following:
- (a) the expiry of the period for negotiating a connection contract under this Part of this Schedule:
 - (b) the date on which the **distributed generator** has fully complied with any conditions (or other measures) that were specified by the **distributor** under clause 18 as conditions of the connection.

Compare: SR 2007/219 clause 24 Schedule 1

Clause 24: substituted, on 23 February 2015, by clause 45 of the Electricity Industry Participation Code Amendment (Distributed Generation) 2014.

Clause 24: amended, on 5 October 2017, by clause 59(1) of the Electricity Industry Participation Code Amendment (Code Review Programme) 2017.

Clause 24(2): amended, on 5 October 2017, by clause 59(2) of the Electricity Industry Participation Code Amendment (Code Review Programme) 2017.

Clause 24(5): amended, on 23 February 2015, by clause 8 of the Electricity Industry Participation Code Amendment (Minor Code Amendments) (No 3) 2014.

Clause 24(5): amended, on 5 October 2017, by clause 59(3) of the Electricity Industry Participation Code Amendment (Code Review Programme) 2017.

Part 3 General provisions

Confidentiality

25 Confidentiality of information provided

- (1) All information given with, or relating to, an application made under this Schedule to a **distributor** must be kept confidential by the **distributor** except as agreed otherwise by the person that gave the information.
- (1A) A **distributor** may require a **distributed generator** to keep confidential information that—
 - (a) is given to the **distributed generator** by the **distributor** for the purpose of an application under this Schedule; and
 - (b) the **distributor** reasonably identifies as being confidential.
- (1B) A **distributor** is excused from processing an application made by a **distributed generator** under this Schedule if the **distributed generator** does not agree to comply with a requirement to keep information confidential imposed under subclause (1A).
- (2) Despite subclause (1), the **distributor**—
 - (a) may, in response to an application under this Schedule, disclose to the applicant that another **distributed generator** has made an application under this Schedule (without identifying who the other **distributed generator** is); and
 - (b) may, in the case of an application under Part 1 of this Schedule, generally indicate the location or proposed location of the **distributed generation** that is the subject of the other application; and
 - (c) may, in the case of an application under Part 2 of this Schedule, disclose the **nameplate capacity** and proposed location of the **distributed generation** that is the subject of the other application.
- (3) The obligation to keep information confidential set out in subclause (1) includes—
 - (a) an obligation not to use the information for any purpose other than considering the application under this Schedule and enabling the connection or continued connection of the **distributed generation**; and
 - (b) an obligation to destroy the information as soon as is reasonably practicable after the later of—
 - (i) the date on which the information is no longer required for the purposes in paragraph (a); and
 - (ii) 60 months after receiving the information.

Compare: SR 2007/219 clause 25 Schedule 1

Heading: amended, on 23 February 2015, by clause 46(1) of the Electricity Industry Participation Code Amendment (Distributed Generation) 2014.

Clause 25(1): substituted, on 23 February 2015, by clause 46(2) of the Electricity Industry Participation Code Amendment (Distributed Generation) 2014.

Clause 25(1A) and (1B): inserted, on 23 February 2015, by clause 46(3) of the Electricity Industry Participation Code Amendment (Distributed Generation) 2014.

Clause 25(2) and (3): substituted, on 23 February 2015, by clause 46(4) of the Electricity Industry Participation Code Amendment (Distributed Generation) 2014.

Clause 25(3)(a): amended, on 5 October 2017, by clause 60 of the Electricity Industry Participation Code Amendment (Code Review Programme) 2017.

Record keeping

Heading: amended, on 29 August 2013, by clause 4(1) of the Electricity Industry Participation (Additional Registry Fields) Code Amendment 2012

26 *[Revoked]*

Compare: SR 2007/219 clause 26 Schedule 1

Clause 26: revoked, on 29 August 2013, by clause 4(2) of the Electricity Industry Participation (Additional Registry Fields) Code Amendment 2012

27 *[Revoked]*

Compare: SR 2007/219 clause 27 Schedule 1

Clause 27: amended, on 21 September 2012, by clause 6 of the Electricity Industry Participation (Minor Amendments) Code Amendment 2012

Clause 27: revoked, on 29 August 2013, by clause 4(2) of the Electricity Industry Participation (Additional Registry Fields) Code Amendment 2012

28 **Distributors must keep records**

A **distributor** must maintain records of each application and notice received under this Schedule and the resulting outcomes, including records of how long it took to approve or decline the application, and justification for these outcomes, for a minimum of 60 months after the day on which the application was approved or declined.

Compare: SR 2007/219 clause 28 Schedule 1

Clause 28: substituted, on 23 February 2015, by clause 47 of the Electricity Industry Participation Code Amendment (Distributed Generation) 2014.

Clause 28: amended, on 1 November 2018, by clause 9 of the Electricity Industry Participation Code Amendment (Code Review Programme) 2018.

Costs

29 **Responsibility for costs under this Schedule**

A **distributor** and **distributed generator** must pay their respective costs (including legal costs) incurred under this Schedule.

Cross heading and clause 29: inserted, on 23 February 2015, by clause 48 of the Electricity Industry Participation Code Amendment (Distributed Generation) 2014.

Schedule 6.2

cl 6.6

Regulated terms for distributed generation

Heading: amended, on 23 February 2015, by clause 49 of the Electricity Industry Participation Code Amendment (Distributed Generation) 2014.

Contents

General

- 1 Contents of this Schedule
- 2 Interpretation
- 3 General obligations

Meters

- 4 Installation of meters and access to metering information

Access

- 5 Right of distributor to access distributed generator's premises
- 6 Process if distributor wants to access distributed generator's premises
- 7 Distributor must not interfere with distributed generator's equipment
- 8 Distributed generator must not interfere with, and must protect, distributor's equipment
- 9 Obligation to advise if interference with distributor's equipment or theft of electricity is discovered

Interruptions and disconnections

- 10 General obligations relating to interruptions
- 11 Circumstances allowing distributor to temporarily electrically disconnect distributed generation
- 12 Obligations if distributed generation temporarily electrically disconnected by distributor
- 13 Adverse operating effects
- 14 Interruptions by distributed generator
- 15 Disconnecting distributed generation

Time frame for construction

- 15A Distributed generator must construct distributed generation within 18 months of approval

Confidentiality

- 16 General obligations relating to confidentiality
- 17 When confidential information can be disclosed
- 18 Disclosures by employees, agents, etc

Pricing

- 19 Pricing principles

Liability

- 20 General obligations relating to liability
 - 21 Exceptions to general obligations relating to liability
 - 22 Limits on liability
 - 23 Liability clauses do not apply to fraud, wilful breach, and breach of confidentiality
 - 24 *[Revoked]*
 - 25 Force majeure
-

General

1 Contents of this Schedule

This Schedule sets out the **regulated terms** that apply to a **distributor** and a **distributed generator** in respect of **distributed generation** that is connected in accordance with clause 6.6 and Schedule 6.1.

Compare: SR 2007/219 clause 1 Schedule 2

Clause 1: amended, on 23 February 2015, by clauses 50 and 75 of the Electricity Industry Participation Code Amendment (Distributed Generation) 2014.

Clause 1: amended, on 5 October 2017, by clause 61 of the Electricity Industry Participation Code Amendment (Code Review Programme) 2017.

Clause 1: amended, on 20 December 2021, by clause 9 of the Electricity Industry Participation Code Amendment (Code Review Programme) 2019.

2 Interpretation

These **regulated terms** must be interpreted—

- (a) in light of the purpose of Part 6 of this Code; and
- (b) so as to give business efficacy to the relationship between the **distributor** and the **distributed generator** created by Part 6 of this Code.

Compare: SR 2007/219 clause 2 Schedule 2

3 General obligations

- (1) The **distributor** and the **distributed generator** must perform all obligations under these **regulated terms** in accordance with **connection and operation standards** (where applicable).
- (2) The **distributor** and the **distributed generator** must each **construct**, connect, operate, test, and **maintain** their respective equipment in accordance with—
 - (a) these **regulated terms**; and
 - (b) **connection and operation standards** (where applicable); and
 - (c) this Code.
- (3) The **distributed generator** must, subject to subclause (2), **construct**, connect, operate, test, and **maintain** its **distributed generation** in accordance with—
 - (a) **reasonable and prudent operating practice**; and
 - (b) the applicable manufacturer's instructions and recommendations.
- (4) The **distributor** and **distributed generator** must each be fully responsible for the respective facilities they own or operate.
- (5) The **distributor** and **distributed generator** must each ensure that their respective facilities adequately protect each other's equipment, personnel, and other persons and their property, from damage and injury.
- (6) The **distributed generator** must comply with any conditions specified by the **distributor** under clause 18 of Schedule 6.1 (or, to the extent that those conditions were the subject of a dispute under clause 20(3) of that Schedule, or of negotiation during the period for negotiation of the connection contract, the conditions or other measures as finally resolved or negotiated).

Compare: SR 2007/219 clause 3 Schedule 2

Clause 3(1): amended, on 23 February 2015, by clause 51(1) of the Electricity Industry Participation Code Amendment (Distributed Generation) 2014.

Clause 3(2) and (3): amended, on 5 October 2017, by clause 62(1) of the Electricity Industry Participation Code Amendment (Code Review Programme) 2017.

Clause 3(6): amended, on 23 February 2015, by clauses 51(2) and 75 of the Electricity Industry Participation Code Amendment (Distributed Generation) 2014.

Clause 3(6): amended, on 5 October 2017, by clause 62(2) of the Electricity Industry Participation Code Amendment (Code Review Programme) 2017.

Meters

4 Installation of meters and access to metering information

(1) *[Revoked]*

(2) The **distributed generator** must give the **distributor**, at the **distributor's** request, the interval data and cumulative data recorded by the **metering installations** at the **point of connection** at which the **distributed generation** is connected or is proposed to be connected.

(3) The **distributed generator** must provide **reactive** metering if—

(a) the **meter** for the **distributed generation** is part of a **category 2 metering installation**, or a higher category of **metering installation**; and

(b) the **distributed generator** is required to do so by the **distributor**.

(4) The **distributor's** requirements in respect of metering measurement and accuracy must be the same as set out in Part 10 of this Code.

Compare: SR 2007/219 clause 4 Schedule 2

Clause 4(1): revoked, on 23 February 2015, by clause 52(1) of the Electricity Industry Participation Code Amendment (Distributed Generation) 2014. Clause 4(2): amended, on 5 October 2017, by clause 63 of the Electricity Industry Participation Code Amendment (Code Review Programme) 2017.

Clause 4(3): substituted, on 1 December 2011, by clause 5 of the Electricity Industry Participation Code (Distributor Use-of-System Agreements and Distributor Tariffs) Amendment 2011.

Clause 4(2) to (4): substituted, on 23 February 2015, by clause 52(2) of the Electricity Industry Participation Code Amendment (Distributed Generation) 2014.

Access

5 Right of distributor to access distributed generator's premises

(1) The **distributed generator** must provide the **distributor**, or a person appointed by the **distributor**, with safe and unobstructed access onto the **distributed generator's** premises at all reasonable times—

(a) for the purpose of installing, testing, inspecting, maintaining, repairing, replacing, operating, reading, or removing any of the **distributor's** equipment and for any other purpose related to these **regulated terms**; and

(b) for the purpose of verifying **metering information**; and

(c) for the purpose of ascertaining the cause of any interference to the quality of delivery services being provided by the **distributor** to the **distributed generator**; and

(d) for the purpose of protecting, or preventing danger or damage to, persons or property; and

(e) for the purposes of **electrically connecting** or **electrically disconnecting** the **distributed generation**; and

(f) for any other purpose relevant to either or both of—

- (i) the **distributor** connecting **distributed generation** in accordance with **connection and operation standards**; and
 - (ii) maintaining the integrity of the **distribution network**.
- (2) The rights of access conferred by these **regulated terms** are in addition to any right of access the **distributor** may have under a statute or regulation or contract.
- Compare: SR 2007/219 clause 5 Schedule 2
Clause 5(1)(e): amended, on 5 October 2017, by clause 64(1) of the Electricity Industry Participation Code Amendment (Code Review Programme) 2017.
Clause 5(1)(f)(i): amended, on 23 February 2015, by clause 75 of the Electricity Industry Participation Code Amendment (Distributed Generation) 2014.
Clause 5(1)(f)(i): amended, on 5 October 2017, by clause 64(2) of the Electricity Industry Participation Code Amendment (Code Review Programme) 2017.

6 Process if distributor wants to access distributed generator's premises

- (1) The **distributor** must exercise its right of access under clause 5 by,—
- (a) wherever practicable, giving to the **distributed generator** reasonable notice of its intention and of the purpose for which it will exercise its right of access; and
 - (b) causing as little inconvenience as practicable to the **distributed generator** in carrying out its work; and
 - (c) observing **reasonable and prudent operating practice** at all times; and
 - (d) observing any reasonable security or site safety requirements that are made known to the **distributor** by the **distributed generator**.
- (2) However, the **distributor** may take all reasonable steps to gain immediate access where it reasonably believes there is immediate danger to persons or property.

Compare: SR 2007/219 clause 6 Schedule 2

7 Distributor must not interfere with distributed generator's equipment

- (1) The **distributor** must not interfere with the **distributed generator's** equipment without the prior written consent of the **distributed generator**.
- (2) However, if emergency action has to be taken to protect the health and safety of persons, or to prevent damage to property, the **distributor**—
- (a) may interfere with the **distributed generator's** equipment without prior written consent; and
 - (b) must, as soon as practicable, inform the **distributed generator** of the occurrence and circumstances involved.

Compare: SR 2007/219 clause 7 Schedule 2

8 Distributed generator must not interfere with, and must protect, distributor's equipment

- (1) The **distributed generator** must not interfere with the **distributor's** equipment without the prior written consent of the **distributor**.
- (2) However, if emergency action has to be taken to protect the health and safety of persons, or to prevent damage to property, the **distributed generator**—
- (a) may interfere with the **distributor's** equipment without prior written consent; and
 - (b) must, as soon as practicable, inform the **distributor** of the occurrence and circumstances involved.

- (3) The **distributed generator** must protect the **distributor's** equipment against interference and damage.
Compare: SR 2007/219 clause 8 Schedule 2
Clause 8(1): amended, on 23 February 2015, by clause 53 of the Electricity Industry Participation Code Amendment (Distributed Generation) 2014.

9 **Obligation to advise if interference with distributor's equipment or theft of electricity is discovered**

- (1) If the **distributor** or the **distributed generator** discovers evidence of interference with the **distributor's** equipment, or evidence of theft of **electricity**, the party discovering the interference or evidence must advise the other party within 24 hours.
- (2) If interference with the **distributor's** equipment at the **distributed generator's** installation is suspected, the **distributor** may itself carry out an investigation and present the findings to the **distributed generator** within a reasonable period.
- (3) The cost of the investigation—
- (a) must be borne by the **distributed generator** if it is discovered that interference by the **distributed generator**, or by its subcontractors, agents, or invitees, has occurred, or if the interference has been by a third party, and the **distributed generator** has failed to provide reasonable protection against interference to the **distributor's** equipment; and
- (b) must be borne by the **distributor** in any other case.

Compare: SR 2007/219 clause 9 Schedule 2

Heading: amended, on 23 February 2015, by clause 54(1) of the Electricity Industry Participation Code Amendment (Distributed Generation) 2014.

Clause 9(1): amended, on 23 February 2015, by clause 54(2) of the Electricity Industry Participation Code Amendment (Distributed Generation) 2014.

Interruptions and disconnections

10 **General obligation relating to interruptions**

The **distributor** must make reasonable endeavours to ensure that the connection of the **distributed generation** is not interrupted.

Compare: SR 2007/219 clause 10 Schedule 2

Clause 10: amended, on 23 February 2015, by clause 75 of the Electricity Industry Participation Code Amendment (Distributed Generation) 2014.

Clause 10: amended, on 5 October 2017, by clause 65 of the Electricity Industry Participation Code Amendment (Code Review Programme) 2017.

11 **Circumstances allowing distributor to temporarily electrically disconnect distributed generation**

Despite clause 10, the **distributor** may interrupt the connection service, or curtail either the operation or output of the generation, or both, and may temporarily **electrically disconnect** the **distributed generation** in any of the following cases:

- (a) in accordance with the **distributor's congestion management policy**;
- (b) if reasonably necessary for planned **maintenance, construction**, and repairs on the **distribution network**;
- (c) for the purpose of protecting, or preventing danger or damage to, persons or property:

- (d) if the **distributed generator** fails to allow the **distributor** access as required by clause 5:
- (e) *[Revoked]*
- (f) in accordance with clause 13 (adverse operating effects):
- (g) if the **distributed generator** fails to comply with the **distributor's**—
 - (i) **connection and operation standards**; or
 - (ii) safety requirements.

Compare: SR 2007/219 clause 11 Schedule 2

Heading: amended, on 5 October 2017, by clause 66(1) of the Electricity Industry Participation Code Amendment (Code Review Programme) 2017.

Clause 11: amended, on 23 February 2015, by clauses 55(1) and 75 of the Electricity Industry Participation Code Amendment (Distributed Generation) 2014.

Clause 11: amended, on 5 October 2017, by clause 66(2) of the Electricity Industry Participation Code Amendment (Code Review Programme) 2017.

Clause 11(e): revoked, on 23 February 2015, by clause 55(2) of the Electricity Industry Participation Code Amendment (Distributed Generation) 2014.

Clause 11(g): inserted, on 23 February 2015, by clause 55(3) of the Electricity Industry Participation Code Amendment (Distributed Generation) 2014.

12 Obligations if distributed generation temporarily electrically disconnected by distributor

- (1) The **distributor** must make reasonable endeavours to—
 - (a) advise the **distributed generator** before an interruption under clause 11; and
 - (b) co-ordinate with the **distributed generator** to minimise the impact of the interruption.
- (2) The **distributor** and the **distributed generator** must co-operate to restore the **distribution network** and the **distributed generation** to a normal operating state as soon as is reasonably practicable following the **distributed generation** being temporarily **electrically disconnected**.
- (3) In the case of a forced outage, the **distributor** must, subject to the need to restore the **distribution network**, make reasonable endeavours to—
 - (a) restore service to the **distributed generator**; and
 - (b) advise the **distributed generator** of the expected duration of the outage.

Compare: SR 2007/219 clause 12 Schedule 2

Heading: amended, on 5 October 2017, by clause 67(1) of the Electricity Industry Participation Code Amendment (Code Review Programme) 2017.

Clause 12(1)(a): amended, on 23 February 2015, by clause 56(1) of the Electricity Industry Participation Code Amendment (Distributed Generation) 2014.

Clause 12(2): amended, on 5 October 2017, by clause 67(2) of the Electricity Industry Participation Code Amendment (Code Review Programme) 2017.

Clause 12(3): amended, on 23 February 2015, by clause 56(2) of the Electricity Industry Participation Code Amendment (Distributed Generation) 2014.

13 Adverse operating effects

- (1) The **distributor** must advise the **distributed generator** as soon as is reasonably practicable if it reasonably considers that operation of the **distributed generation** may—
 - (a) adversely affect the service provided to other **distribution network** customers; or
 - (b) cause damage to the **distribution network** or other facilities; or
 - (c) present a hazard to a person.

- (2) If, after receiving that advice, the **distributed generator** fails to remedy the adverse operating effect within a reasonable time, the **distributor** may **electrically disconnect the distributed generation** by giving reasonable notice (or without notice when reasonably necessary in the event of an emergency or hazardous situation).

Compare: SR 2007/219 clause 13 Schedule 2

Clause 13(1): amended, on 23 February 2015, by clause 57(1) of the Electricity Industry Participation Code Amendment (Distributed Generation) 2014.

Clause 13(2): amended, on 23 February 2015, by clause 57(2) of the Electricity Industry Participation Code Amendment (Distributed Generation) 2014.

Clause 13(2): amended, on 5 October 2017, by clause 68 of the Electricity Industry Participation Code Amendment (Code Review Programme) 2017.

14 Interruptions by distributed generator

- (1) This clause applies to any connected **distributed generation** above 10 kW in total.
- (2) The **distributed generator** must advise the **distributor** of any **planned outages** and must make reasonable endeavours to advise the **distributor** of an event that affects **distribution network** operations.
- (3) The **distributed generator** must make reasonable endeavours to advise the **distributor** of the interruption and to co-ordinate with the **distributor** to minimise the impact of the interruption.

Compare: SR 2007/219 clause 14 Schedule 2

Clause 14: amended, on 23 February 2015, by clauses 58 and 75 of the Electricity Industry Participation Code Amendment (Distributed Generation) 2014.

Clause 14(1): amended, on 5 October 2017, by clause 69 of the Electricity Industry Participation Code Amendment (Code Review Programme) 2017.

15 Disconnecting distributed generation

- (1) Despite clause 10, the **distributor** may disconnect **distributed generation** in the following circumstances:
- (a) on receipt of a request from a **distributed generator**:
- (b) without notice, if a **distributed generator** has been temporarily **electrically disconnected** under clause 11(g) and—
- (i) the **distributed generator** fails to remedy the non-compliance within a reasonable period of time; and
- (ii) there is an ongoing risk to persons or property:
- (c) without notice, if the **trader** that is recorded in the **registry** as being responsible for the **ICP** to which the **distributed generation** is connected to the **distribution network** has **electrically disconnected** the **ICP** and updated the **ICP's** status in the **registry** to "inactive" with the reason of "electrically disconnected – ready for decommissioning":
- (d) on at least 10 **business days'** notice of intention to disconnect, if—
- (i) the **distributed generator** has not injected **electricity** into the **distribution network** at any time in the preceding 12 months; and
- (ii) the **distributed generator** has not given written notice to the **distributor** of the reasons for the non-injection; and
- (iii) the **distributor** has reasonable grounds for believing that the **distributed generator** has ceased to operate the **distributed generation**.
- (2) *[Revoked]*

- (3) If a **distributor** disconnects **distributed generation** under subclause (1) and the **point of connection** is to be **decommissioned**, the **distributor** must—
- (a) remove all electrical conductors between the **distributed generation** and the **distributor's lines**;
 - (b) advise the **distributed generator** within 2 **business days** of the completion of the work referred to in paragraph (a).

(4) *[Revoked]*

(5) *[Revoked]*

Compare: SR 2007/219 clause 15 Schedule 2

Heading: replaced, on 5 October 2017, by clause 70(1) of the Electricity Industry Participation Code Amendment (Code Review Programme) 2017.

Clause 15(1): amended, on 5 October 2017, by clause 70(2) of the Electricity Industry Participation Code Amendment (Code Review Programme) 2017.

Clause 15(1)(b): amended, on 5 October 2017, by clause 70(3) of the Electricity Industry Participation Code Amendment (Code Review Programme) 2017.

Clause 15(1)(b) and (c): substituted, on 23 February 2015, by clause 59(1) of the Electricity Industry Participation Code Amendment (Distributed Generation) 2014.

Clause 15(1)(c): amended, on 5 October 2017, by clause 70(4) of the Electricity Industry Participation Code Amendment (Code Review Programme) 2017.

Clause 15(1)(d)(i): amended, on 23 February 2015, by clause 59(2) of the Electricity Industry Participation Code Amendment (Distributed Generation) 2014.

Clause 15(1)(d)(ii): replaced, on 5 October 2017, by clause 70(5) of the Electricity Industry Participation Code Amendment (Code Review Programme) 2017.

Clause 15(2): revoked, on 23 February 2015, by clause 59(3) of the Electricity Industry Participation Code Amendment (Distributed Generation) 2014.

Clause 15(3): amended, on 23 February 2015, by clause 59(4) of the Electricity Industry Participation Code Amendment (Distributed Generation) 2014.

Clause 15(3): replaced, on 5 October 2017, by clause 70(6) of the Electricity Industry Participation Code Amendment (Code Review Programme) 2017.

Clause 15(4) and (5): revoked, on 23 February 2015, by clause 59(5) of the Electricity Industry Participation Code Amendment (Distributed Generation) 2014.

Time frame for construction

15A Distributed generator must construct distributed generation within 18 months of approval

- (1) This clause applies if the **distributor** approves the **distributed generator's** application to connect **distributed generation** under Part 1, Part 1A, or Part 2 of Schedule 6.1.
- (2) The **regulated terms** cease to apply if the **distributed generator** does not **construct the distributed generation** within—
 - (a) 18 months from the date on which approval was granted; or
 - (b) such later date as is agreed by the **distributor** and **distributed generator**.
- (3) The **distributed generator** must reapply under Schedule 6.1 if—
 - (a) the **regulated terms** no longer apply in accordance with subclause (1); and
 - (b) the **distributed generator** wishes to connect **distributed generation** to the **distributor's distribution network**.

Cross heading and clause 15A: inserted, on 23 February 2015, by clause 60 of the Electricity Industry Participation Code Amendment (Distributed Generation) 2014.

Clause 15A: amended, on 5 October 2017, by clause 71 of the Electricity Industry Participation Code Amendment (Code Review Programme) 2017.

Confidentiality

16 General obligations relating to confidentiality

- (1) Each party must preserve the confidentiality of **confidential information**, and must not directly or indirectly reveal, report, publish, transfer, or disclose the existence of any **confidential information**, except as permitted in subclause (2).
- (2) Each party must only use **confidential information** for the purposes expressly permitted by these **regulated terms**.

Compare: SR 2007/219 clause 17 Schedule 2

17 When confidential information can be disclosed

Either party may disclose **confidential information** in any of the following circumstances:

- (a) if the **distributed generator** and **distributor** agree in writing to the disclosure of information:
- (b) if disclosure is expressly provided for under these **regulated terms**:
- (c) if, at the time of receipt by the party, the **confidential information** is in the public domain or if, after the time of receipt by either party, the **confidential information** enters the public domain (except where it does so as a result of a breach by either party of its obligations under this clause or a breach by any other person of that person's obligation of confidence):
- (d) if either party is required to disclose **confidential information** by—
 - (i) a statutory or regulatory obligation, body, or authority; or
 - (ii) a judicial or arbitration process; or
 - (iii) the regulations of a stock exchange upon which the share capital of either party is from time to time listed or dealt in; or
 - (iv) this Code:
- (e) if the **confidential information** is released to the officers, employees, directors, agents, or advisors of the party, provided that—
 - (i) the information is disseminated only on a need-to-know basis; and
 - (ii) recipients of the **confidential information** have been made fully aware of the party's obligations of confidence in relation to the information; and
 - (iii) any copies of the information clearly identify it as **confidential information**:
- (f) if the **confidential information** is released to a bona fide potential purchaser of the business or any part of the business of a party, subject to that bona fide potential purchaser having signed a confidentiality agreement enforceable by the other party in a form approved by that other party, and that approval may not be unreasonably withheld.

Compare: SR 2007/219 clause 18 Schedule 2

18 Disclosures by employees, agents, etc

To avoid doubt, a party is responsible for any unauthorised disclosure of **confidential information** made by that party's officers, employees, directors, agents, or advisors.

Compare: SR 2007/219 clause 19 Schedule 2

Pricing

19 Pricing principles

Charges that are payable by the **distributed generator** or the **distributor** must be determined in accordance with the pricing principles set out in Schedule 6.4.

Compare: SR 2007/219 clause 20 Schedule 2

Clause 19: amended, on 23 February 2015, by clause 61 of the Electricity Industry Participation Code Amendment (Distributed Generation) 2014.

Liability

20 General obligations relating to liability

- (1) If the **distributor** or the **distributed generator** breaches any of the **regulated terms** (whether by act or omission), that party is liable to the other.
- (2) The **distributed generator's** and the **distributor's** liability to each other is limited to damages for any direct loss caused by that breach.
- (3) This clause and clauses 21 to 25 do not limit the liability of either party to pay all charges and other amounts due under Part 6 of this Code or the **regulated terms**.

Compare: SR 2007/219 clause 21 Schedule 2

Clause 20(1) and (3): amended, on 23 February 2015, by clause 62 of the Electricity Industry Participation Code Amendment (Distributed Generation) 2014.

21 Exceptions to obligations relating to liability

- (1) Neither the **distributor** nor the **distributed generator**, nor any of its officers, employees, directors, agents, or advisors, are in any circumstances liable to the other party for—
 - (a) any indirect loss, consequential loss (including, but not limited to, incidental or special damages), loss of profit, loss of revenue (except any liability under clause 20(3)), loss of use, loss of opportunity, loss of contract, or loss of goodwill; or
 - (b) any loss resulting from the liability of the other party to another person; or
 - (c) any loss or damage incurred by the other party if, and to the extent that, this results from any breach of the **regulated terms** or any negligent action.
- (2) The **distributor** is not liable, except to the extent caused or contributed to by the **distributor** in circumstances where the **distributor** was not acting in accordance with Part 6 of this Code (including these **regulated terms**), for—
 - (a) any momentary fluctuations in the voltage or frequency of **electricity** conveyed to or from the **distributed generation's point of connection** or nonconformity with harmonic voltage and current levels; or
 - (b) any failure to convey **electricity** to the extent that—
 - (i) the failure arises from any act or omission of the **distributed generator** or other person, excluding the **distributor** and its officers, employees, directors, agents, or advisors; or

- (ii) the failure arises from a reduced **injection** of **electricity** into the **distribution network**; or
 - (iia) the failure arises from an interruption in the conveyance of **electricity** in the **distribution network**, if the interruption was at the request of the **system operator** or under a nationally or regionally co-ordinated response to an **electricity** shortage; or
 - (iii) the failure arises from any defect or abnormal conditions in or about the **distributed generator's** premises; or
 - (iv) the **distributor** was taking any action in accordance with Part 6 of this Code or the **regulated terms**; or
 - (v) the **distributor** was prevented from making necessary repairs (for example, by police at an accident scene).
- (3) The **distributed generator** is not liable for—
- (a) a failure to perform an obligation under these **regulated terms** caused by the **distributor's** failure to comply with the obligation; or
 - (b) a failure to perform an obligation under these **regulated terms** arising from any defect or abnormal conditions in the **distribution network**.

Compare: SR 2007/219 clause 22 Schedule 2

Clause 21(1): amended, on 23 February 2015, by clause 63(1) of the Electricity Industry Participation Code Amendment (Distributed Generation) 2014.

Clause 21(2)(b)(ii): substituted, on 23 February 2015, by clause 63(2) of the Electricity Industry Participation Code Amendment (Distributed Generation) 2014.

Clause 21(2)(b)(iia): inserted, on 23 February 2015, by clause 63(3) of the Electricity Industry Participation Code Amendment (Distributed Generation) 2014.

22 Limits on liability

The maximum total liability of each party, as a result of a breach of the **regulated terms**, must not in any circumstances exceed, in respect of a single event or series of events arising from the same event or circumstance, the lesser of—

- (a) the direct damage suffered or the maximum total liability that the party bringing the claim against the other party has at the time that the event (or, in the case of a series of related events, the first of such events) giving rise to the liability occurred; or
- (b) \$1,000 per kW of **nameplate capacity** up to a maximum of \$5 million.

Compare: SR 2007/219 clause 23 Schedule 2

Clause 22(b): amended, on 23 February 2015, by clause 64 of the Electricity Industry Participation Code Amendment (Distributed Generation) 2014.

23 Liability clauses do not apply to fraud, wilful breach, and breach of confidentiality

The exceptions in clause 21, and the limits on liability in clause 22, do not apply—

- (a) if the **distributor** or the **distributed generator**, or any of its officers, employees, directors, agents, or advisors, has acted fraudulently or wilfully in breach of these **regulated terms**; or
- (b) to a breach of confidentiality under clause 16 by either party.

Compare: SR 2007/219 clause 24 Schedule 2

Clause 23(a): amended, on 23 February 2015, by clause 65 of the Electricity Industry Participation Code Amendment (Distributed Generation) 2014.

24 *[Revoked]*

Compare: SR 2007/219 clause 25 Schedule 2
Clause 24: revoked, on 23 February 2015, by clause 66 of the Electricity Industry Participation Code Amendment (Distributed Generation) 2014.

25 Force majeure

- (1) A failure by either party to comply with or observe any provisions of these **regulated terms** (other than payment of any amount due) does not give rise to any cause of action or liability based on default of the provision if—
- (a) the failure is caused by—
 - (i) an event or circumstance occasioned by, or in consequence of, an act of God, being an event or circumstance—
 - (A) due to natural causes, directly or indirectly and exclusively without human intervention; and
 - (B) that could not reasonably have been foreseen or, if foreseen, could not reasonably have been resisted; or
 - (ii) a strike, lockout, other industrial disturbance, act of public enemy, war, blockade, insurrection, riot, epidemic, aircraft, or civil disturbance; or
 - (iii) the binding order or requirement of a Court, government, **local authority**, the **Rulings Panel**, or the **Authority**, and the failure is not within the reasonable control of the affected party; or
 - (iv) the partial or entire failure of the **injection of electricity** into the **distribution network**; or
 - (v) any other event or circumstance beyond the control of the party invoking this clause; and
 - (b) the party could not have prevented such failure by the exercise of the degree of skill, diligence, prudence, and foresight that would reasonably and ordinarily be expected from a skilled and experienced **distributor** or **distributed generator** engaged in the same type of undertaking under the same or similar circumstances in New Zealand at the time.
- (2) If a party becomes aware of a prospect of a forthcoming **force majeure event**, it must advise the other party as soon as is reasonably practicable of the particulars of which it is aware.
- (3) If a party invokes this clause, it must as soon as is reasonably practicable advise the other party that it is invoking this clause and of the full particulars of the **force majeure event** relied on.
- (4) The party invoking this clause must—
- (a) use all reasonable endeavours to overcome or avoid the **force majeure event**; and
 - (b) use all reasonable endeavours to mitigate the effects or the consequences of the **force majeure event**; and
 - (c) consult with the other party on the performance of the obligations referred to in paragraphs (a) and (b).
- (5) Nothing in subclause (4) requires a party to settle a strike, lockout, or other industrial disturbance by acceding, against its judgement, to the demands of opposing parties.

Compare: SR 2007/219 clause 26 Schedule 2

Electricity Industry Participation Code 2010
Schedule 6.2

Clause 25(1)(a)(iv): substituted, on 23 February 2015, by clause 67(1) of the Electricity Industry Participation Code Amendment (Distributed Generation) 2014.

Clause 25(2) and (3): amended, on 23 February 2015, by clause 67(2) of the Electricity Industry Participation Code Amendment (Distributed Generation) 2014.

Schedule 6.3 Default dispute resolution process

cl 6.8

Contents

-
- 1 Application of this schedule
 - 2 Notice of dispute
 - 3 Complaints
 - 4 Application of pricing principles to disputes
 - 5 Orders that Rulings Panel can make
-

1 Application of this Schedule

This Schedule applies in accordance with clause 6.8.

Compare: SR 2007/219 clause 1 Schedule 3

Clause 1: substituted, on 23 February 2015, by clause 68 of the Electricity Industry Participation Code Amendment (Distributed Generation) 2014.

2 Notice of dispute

- (1) A party must give written notice to the other party of the dispute.
- (2) The parties must attempt to resolve the dispute with each other in good faith.
- (3) If the parties are unable to resolve the dispute, either party may complain in writing to the **Authority**.

Compare: SR 2007/219 clause 2 Schedule 3

3 Complaints

- (1) A complaint made under clause 2(3) must be treated as if it were a notification given under regulations made under section 112 of the **Act**.
- (2) The following provisions apply to the complaint:
 - (a) sections 53-62 of the **Act**; and
 - (b) the Electricity Industry (Enforcement) Regulations 2010 except regulations 5, 6, 7, 9, 17, 51 to 75, and subpart 2 of Part 3.
- (3) Those provisions apply—
 - (a) to the dispute that is the subject of the complaint in the same way as those provisions apply to a notification of an alleged breach of this Code; and
 - (b) as if references to a **participant** in those provisions were references to a party under Part 6 of this Code; and
 - (c) with any further modifications that the **Authority** or the **Rulings Panel**, as the case may be, considers necessary or desirable for the purpose of applying those provisions to the complaint.

Compare: SR 2007/219 clause 3 Schedule 3

4 Application of pricing principles to disputes

- (1) The **Authority** and the **Rulings Panel** must apply the pricing principles set out in Schedule 6.4 to determine any connection charges payable.
- (2) Subclause (1) applies if—

- (a) there is a dispute under Part 6 of this Code; and
- (b) in the opinion of the **Authority** or the **Rulings Panel** it is necessary or desirable to apply subclause (1) in order to resolve the dispute.

Compare: SR 2007/219 clause 4 Schedule 3

Clause 4(1): amended, on 23 February 2015, by clause 75 of the Electricity Industry Participation Code Amendment (Distributed Generation) 2014.

Clause 4(1): amended, on 5 October 2017, by clause 72 of the Electricity Industry Participation Code Amendment (Code Review Programme) 2017.

5 Orders that Rulings Panel can make

If a complaint is referred to it, the **Rulings Panel** may make any order, or take any action, that it is able to make or take in accordance with section 54 of the **Act**.

Compare: SR 2007/219 clause 5 Schedule 3

Schedule 6.4 Pricing principles

cl 6.9

- 1 This Schedule sets out the pricing principles to be applied for the purposes of Part 6 of this Code in accordance with clause 6.9 (which relates to clause 19 of Schedule 6.2 and clause 4 of Schedule 6.3).

Compare: SR 2007/219 clause 1 Schedule 4

Clause 1: amended, on 23 February 2015, by clause 69 of the Electricity Industry Participation Code Amendment (Distributed Generation) 2014.

- 2 The pricing principles are as follows:

Charges to be based on recovery of reasonable costs incurred by distributor as a result of connecting the distributed generator and to comply with connection and operation standards within the distribution network, and must include consideration of any identifiable avoided or avoidable costs

- (a) subject to paragraph (i), connection charges in respect of **distributed generation** must not exceed the **incremental costs** of providing connection services to the **distributed generation**:
- (b) when calculating **incremental costs**, any costs that cannot be calculated must be estimated with reference to reasonable estimates of how the **distributor's** capital investment decisions and operating costs would differ, in the future, with and without the generation:
- (c) estimated costs may be adjusted ex post. Ex-post adjustment involves calculating, at the end of a period, what the actual costs incurred by the **distributor** as a result of the **distributed generation** being **electrically connected** to the **distribution network** were and deducting the costs that would have been incurred had the generation not been **electrically connected**. In this case, if the costs differ from the costs charged to the **distributed generator**, the **distributor** must advise the **distributed generator** and recover or refund those costs after they are incurred (unless the **distributor** and the **distributed generator** agree otherwise):

Capital and operating expenses

- (d) if costs include distinct capital expenditure, such as costs for a significant **asset** replacement or upgrade, the connection charge attributable to the **distributed generator's** actions or proposals is payable by the **distributed generator** before the **distributor** has committed to incurring those costs. When making reasonable endeavours to facilitate connection, the **distributor** is not obliged to incur those costs until that payment has been received:
- (e) if **incremental costs** are negative, the **distributed generator** is deemed to be providing network support services to the **distributor**, and may invoice the **distributor** for this service and, in that case, the **distributed generator** must

comply with all relevant obligations (for example, obligations under Part 6 of this Code and in respect of tax):

- (f) if costs relate to ongoing or periodic operating expenses, such as costs for routine **maintenance**, the connection charge attributable to the **distributed generator's** actions or proposals may take the form of a periodic charge:
- (g) *[Revoked]*
- (h) after the connection of the **distributed generation**, the **distributor** may review the connection charges payable by a **distributed generator** not more than once in any 12-month period. Following a review, the **distributor** must advise the **distributed generator** in writing of any change in the connection charges payable, and the reasons for any change, not less than 3 months before the date the change is to take effect:

Share of generation-driven costs

- (i) if multiple **distributed generators** are sharing an investment, the portion of costs payable by any 1 **distributed generator**—
 - (i) must be calculated so that the charges paid or payable by each **distributed generator** take into account the relative expected peak of each **distributed generator's** injected generation; and
 - (ii) may also have regard to the percentage of **assets** that will be used by each **distributed generator**, the percentage of **distribution network capacity** used by each **distributed generator**, the relative share of expected maximum combined peak output, and whether the combined peak generation is coincident with the peak load on the **distribution network**:
- (j) in order to facilitate the calculation of equitable connection charges under paragraph (i), the **distributor** must make and retain adequate records of investments for a period of 60 months, provide the rationale for the investment in terms of facilitating **distributed generation**, and indicate the extent to which the associated costs have been or are to be recovered through generation connection charges:

Repayment of previously funded investment

- (k) if a **distributed generator** has paid connection charges that include (in part) the cost of an investment that is subsequently shared by other **distributed generators**, the **distributor** must refund to the **distributed generator** all connection charges paid to the **distributor** under paragraph (i) by other **distributed generators** in respect of that investment:
- (l) if there are multiple prior **distributed generators**, a refund to each **distributed generator** referred to in paragraph (k) must be provided in accordance with the expected peak of that **distributed generator's** injected generation over a period of time agreed between the **distributed generator** and the **distributor**. The refund—

- (i) must take into account the relative expected peak of each **distributed generator's** injected generation; and
- (ii) may also have regard to the percentage of **assets** that will be used by each **distributed generator**, the percentage of **distribution network capacity** used by each **distributed generator**, the relative share of expected maximum combined peak output, and whether the combined peak generation is coincident with the peak load on the **distribution network**:
- (m) no refund of previous payments from the **distributed generator** referred to in paragraph (k) is required after a period of 36 months from the initial connection of that **distributed generator**:

Non-firm connection service

- (n) to avoid doubt, nothing in Part 6 of this Code creates any **distribution network capacity** or property rights in any part of the **distribution network** unless these are specifically contracted for. **Distributors** must **maintain** connection and **lines** services to **distributed generators** in accordance with their **connection and operation standards**.

Compare: SR 2007/219 clause 2 Schedule 4

Heading: amended, on 23 February 2015, by clause 70(1) of the Electricity Industry Participation Code Amendment (Distributed Generation) 2014.

Clause 2: amended, on 23 February 2015, by clause 70(2) of the Electricity Industry Participation Code Amendment (Distributed Generation) 2014.

Clause 2: amended, on 1 April 2023, by clause 5(1) of the Electricity Industry Participation Code Amendment (Avoided Cost of Transmission) 2022.

Clause 2(a): amended, on 23 February 2015, by clauses 70(3) and 75 of the Electricity Industry Participation Code Amendment (Distributed Generation) 2014.

Clause 2(a): replaced, on 9 January 2017, by clause 4 of the Electricity Industry Participation Code Amendment (Distributed Generation) 2016.

Clause 2(a): amended, on 5 October 2017, by clause 73(1) of the Electricity Industry Participation Code Amendment (Code Review Programme) 2017.

Clause 2(a) and (b): amended, on 1 April 2023, by clause 5(2) of the Electricity Industry Participation Code Amendment (Avoided Cost of Transmission) 2022.

Clause 2(c): amended, on 23 February 2015, by clauses 70(4) and 75 of the Electricity Industry Participation Code Amendment (Distributed Generation) 2014.

Clause 2(c): amended, on 5 October 2017, by clause 73(2) of the Electricity Industry Participation Code Amendment (Code Review Programme) 2017.

Clause 2(d): amended, on 23 February 2015, by clause 75 of the Electricity Industry Participation Code Amendment (Distributed Generation) 2014.

Clause 2(d), (f), (h), (j), (k), and (m): amended, on 5 October 2017, by clause 73(3) of the Electricity Industry Participation Code Amendment (Code Review Programme) 2017.

Clause 2(f): amended, on 23 February 2015, by clauses 70(5) and 75 of the Electricity Industry Participation Code Amendment (Distributed Generation) 2014.

Clause 2(g): revoked, on 23 February 2015, by clause 70(6) of the Electricity Industry Participation Code Amendment (Distributed Generation) 2014.

Clause 2(h): amended, on 23 February 2015, by clauses 70(7) and 75 of the Electricity Industry Participation Code Amendment (Distributed Generation) 2014.

Clause 2(i)(ii): amended, on 23 February 2015, by clause 70(8) of the Electricity Industry Participation Code Amendment (Distributed Generation) 2014.

Clause 2(j): amended, on 23 February 2015, by clauses 70(9) and 75 of the Electricity Industry Participation Code Amendment (Distributed Generation) 2014.

Clause 2(k): amended, on 23 February 2015, by clause 75 of the Electricity Industry Participation Code Amendment (Distributed Generation) 2014.

Clause 2(l)(ii): amended, on 23 February 2015, by clause 70(10) of the Electricity Industry Participation Code Amendment (Distributed Generation) 2014.

Clause 2(m): amended, on 23 February 2015, by clauses 70(11) and 75 of the Electricity Industry Participation Code Amendment (Distributed Generation) 2014.

Electricity Industry Participation Code 2010
Schedule 6.4

Clause 2(n): amended, on 23 February 2015, by clauses 70(2) and 75 of the Electricity Industry Participation Code Amendment (Distributed Generation) 2014.

Clause 2(n): amended, on 5 October 2017, by clause 73(4) of the Electricity Industry Participation Code Amendment (Code Review Programme) 2017.

2A *[Revoked]*

Clause 2A: inserted, on 9 January 2017, by clause 5 of the Electricity Industry Participation Code Amendment (Distributed Generation) 2016.

Clause 2A(5): amended, on 5 October 2017, by clause 74 of the Electricity Industry Participation Code Amendment (Code Review Programme) 2017.

Clause 2A: revoked, on 1 April 2023, by clause 5(3) of the Electricity Industry Participation Code Amendment (Avoided Cost of Transmission) 2022.

2B *[Revoked]*

Clause 2B: inserted, on 9 January 2017, by clause 5 of the Electricity Industry Participation Code Amendment (Distributed Generation) 2016.

Clause 2B: revoked, on 1 April 2023, by clause 5(3) of the Electricity Industry Participation Code Amendment (Avoided Cost of Transmission) 2022.

2C *[Revoked]*

Clause 2C: inserted, on 9 January 2017, by clause 5 of the Electricity Industry Participation Code Amendment (Distributed Generation) 2016.

Clause 2C(2)(a): amended, on 5 October 2017, by clause 75 of the Electricity Industry Participation Code Amendment (Code Review Programme) 2017.

Clause 2C: revoked, on 1 April 2023, by clause 5(3) of the Electricity Industry Participation Code Amendment (Avoided Cost of Transmission) 2022.

3 *[Revoked]*

Compare: SR 2007/219 clause 3 Schedule 4

Clause 3: revoked, on 23 February 2015, by clause 71 of the Electricity Industry Participation Code Amendment (Distributed Generation) 2014.

4 *[Revoked]*

Clause 4: inserted, on 5 October 2017, by clause 76 of the Electricity Industry Participation Code Amendment (Code Review Programme) 2017.

Clause 4: revoked, on 1 April 2023, by clause 5(3) of the Electricity Industry Participation Code Amendment (Avoided Cost of Transmission) 2022.

Schedule 6.5 cls 2(4), 7(5), 11(4), and 22(5) of Sch 6.1 Prescribed maximum fees

- 1 *[Revoked]*
Clause 1: revoked, on 23 February 2015, by clause 72 of the Electricity Industry Participation Code Amendment (Distributed Generation) 2014.
- 2 A **distributor** may require the payment of fees for any of the following activities prescribed under Part 6 of this Code to the maximum fee specified in the column opposite that activity:

Description of fee	\$ (exclusive of GST)
Part 1 of Schedule 6.1 application	
Application fee under clause 2(2)(c)	200
Fee for observation of testing and inspection under clause 7(5)	60
Part 1A of Schedule 6.1 application	
Application fee under clause 9B(2)(c)	100
Fee for inspection under clause 9C(3)	60
Deficiency fee under clause 9E(4)	80
Part 2 of Schedule 6.1 application	
Application fee for distributed generation with nameplate capacity of more than 10 kW but less than 100 kW under clause 11(2)(c)	500
Application fee for distributed generation with nameplate capacity of 100 kW or more in total but less than 1 MW under clause 11(2)(c)	1,000
Application fee for distributed generation with nameplate capacity of 1 MW or more under clause 11(2)(c)	5,000
Fee for observation of testing and inspection of distributed generation with	120

Electricity Industry Participation Code 2010
Schedule 6.5

nameplate capacity of more than 10 kW but less than 100 kW under clause 22(5)	
Fee for observation of testing and inspection of distributed generation with nameplate capacity of 100 kW or more under clause 22(5)	1,200

Compare: SR 2007/219 Schedule 5

Clause 2: substituted, on 23 February 2015, by clause 73 of the Electricity Industry Participation Code Amendment (Distributed Generation) 2014.

Electricity Industry Participation Code 2010

Part 6A

Separation of distribution from certain generation and retailing

Part 6A: inserted on 1 September 2022, by the Electricity Industry Amendment Act 2021

Contents

- 6A.1 Purpose and outline of this Part
- 6A.2 Interpretation
 - Corporate separation and arm's-length rules*
- 6A.3 Corporate separation and arm's length rules applying to distributors and connected generators and connected retailers
 - Other rules*
- 6A.4 Distributor agreements
- 6A.5 Person involved in distributor must not pay for transfer of retail customers to connected retailers
- 6A.6 No discrimination when paying rebates or dividends
 - Disclosure and reporting to Authority*
- 6A.7 Disclosure of information to Authority
- 6A.8 Directors must report compliance with arm's length rules
 - Part 6A dispensations*
- 6A.9 Authority may grant Part 6A dispensation to specified person

Schedule 6A.1 Arm's-length rules

1 Objective

2 Interpretation

3 Arm's-length rules

Duty to ensure arm's length objective is met

Arms-length test

Duty not to prefer interests of business B

Duty not to discriminate in favour of business B

Duty to focus on interests of right ultimate owners

Duty of directors and managers of parents of business A

At least 2 independent directors

No cross-directors who are executive directors

Separate management rules

Directors and managers must not be placed under certain obligations

Restriction on use of information

Records

Practical considerations

4 Rules do no limit objective

6A.1 Purpose and outline of this Part

- (1) The purpose of this Part is to promote competition in the electricity industry by restricting relationships between a **distributor** and a generator or a **retailer**, where those relationships may not otherwise be at arm's length.
- (2) In general terms, this Part imposes rules in respect of **distributors** as follows:
 - (a) corporate separation and arm's-length rules, if a person is involved both in a **distributor** and in either or both of—
 - (i) a generator that generates more than 50 MW of generation connected to the **distributor's** network; or
 - (ii) a **retailer** that retails more than 75 GWh per year to customers connected to the **distributor's** network:
 - (b) **distributor agreement** rules, if—
 - (i) a connected retailer retails more than 5 GWh per year to customers connected to the **distributor's** local network; or
 - (ii) a connected generator has a capacity of more than 10 MW of generation that is connected to any of the **distributor's** networks:
 - (c) rules preventing persons involved in **distributors** from paying **retailers** in respect of the transfer of retail customers:
 - (d) no-discrimination rules that apply when **distributors**, or electricity trusts or customer co-operatives involved in **distributors**, pay dividends or rebates.
- (3) Subclause (2) is intended only as a guide to the general scheme and effect of this Part.

Compare: 2010 No 116 s 72

Clause 6A.1(1), (2), (2)(a), (2)(a)(i) and (ii), (2)(b), (2)(b)(i) and (ii), 2(c) and 2(d): amended, on 1 March 2024, by clause 10 of the Electricity Industry Participation Code Amendment (Code Review Programme) 2024.

6A.2 Interpretation

In this Part and Schedule 6A.1, unless the context otherwise requires,—

arm's-length rules means the objective and rules set out in Schedule 6A.1
assets *[Revoked]*

associate has the meaning given to it by section 6A of the **Act**

business has the meaning given to it by section 5 of the **Act**

consumer *[Revoked]*

customer *[Revoked]*

director *[Revoked]*

financial year has the meaning given to it by section 6A of the **Act**

generator has the meaning given to it by section 5 of the **Act**

involved in has the meaning given to it by section 6A of the **Act**

network has the meaning given to it by section 5 of the **Act**

retailer *[Revoked]*

total capacity has the meaning given to it by section 73(3) of the **Act**.

Compare: 2010 No 116 s 73

Clause 6A.2 Interpretation of assets, consumer, customer, director and retailer: revoked, on 1 March 2024, by clause 11(1) of the Electricity Industry Participation Code Amendment (Code Review Programme) 2024.

Clause 6A.2 Interpretation of associate, business, financial year, generator, involved in, network and total capacity: amended, on 1 March 2024, by clause 11(2) of the Electricity Industry Participation Code Amendment (Code Review Programme) 2024.

Corporate separation and arm's-length rules

6A.3 Corporate separation and arm's-length rules applying to distributors and connected generators and connected retailers

- (1) The person or persons who carry on the business of **distribution** must carry on that business in a different company from the company that carries on the business of a connected generator or a connected retailer.
- (2) Every person who is involved in a **distributor**, and every person who is involved in a connected generator or a connected retailer, must comply, and ensure that the person's businesses comply, with the arm's-length rules.

- (3) In this clause, unless the context otherwise requires,—

connected generator, in relation to a **distributor**, means a generator—

- (a) that has a total capacity of more than 50 MW of generation that is connected to any of the **distributor's** networks; and
- (b) in respect of which the **distributor**, or any other person involved in the **distributor**, is involved

connected retailer, in relation to a **distributor**, means a **retailer**—

- (a) that is involved in retailing more than 75 GWh of **electricity** in a financial year to customers who are connected to any of the **distributor's** networks; and
- (b) in respect of which the **distributor**, or any other person involved in the **distributor**, is involved.

Compare: 2010 No 116 s 76

Clause 6A.3(1), (2) and (3): amended, on 1 March 2024, by clause 12 of the Electricity Industry Participation Code Amendment (Code Review Programme) 2024.

Other rules

6A.4 Distributor agreements

- (1) Every director of a **distributor** in respect of which there is a connected retailer or a connected generator must ensure that—
 - (a) the **distribution** business has a comprehensive, written **distributor agreement** that provides for the supply of **line function services** and information to the connected retailer or connected generator (as the case may be); and
 - (b) the terms of that **distributor agreement** do not discriminate in favour of one business and do not contain arrangements that include elements that the business usually omits, or omit elements that the business usually includes, in **distributor agreements** with parties that are—
 - (i) connected or related only by the transaction or dealing in question; and

-
- (ii) acting independently; and
 - (iii) each acting in its own best interests; and
 - (c) the business operates in accordance with that **distributor agreement**; and
 - (d) the business **publishes** that **distributor agreement** and provides it to the **Authority**.
- (2) A **distributor agreement** required by subclause (1)(a) must be entered into, in the case of a business to which the corporate separation rule does not apply, as if the distribution business and the connected retailer or connected generator were separate legal persons.
- (3) In this clause, unless the context otherwise requires,—
- connected generator**, in relation to a **distributor**, means a generator—
- (a) that has a total capacity of more than 10 MW of generation that is connected to any of the **distributor's** networks; and
 - (b) in respect of which the **distributor**, or any other person involved in the **distributor**, is involved
- connected retailer**, in relation to a **distributor**, means a **retailer**—
- (a) that is involved in retailing more than 5 GWh of **electricity** on the **distributor's** local network in a financial year to customers who are connected to that network; and
 - (b) in respect of which the **distributor**, or any other person involved in the **distributor**, is involved
- local network** means a network operated by a **distributor** in a contiguous geographic area or areas.
- (4) The directors of the **distributor** must ensure that there is also **published**, and provided to the **Authority**, a certificate signed by those directors stating whether, in the preceding calendar year,—
- (a) the terms in the **distributor agreement** are a true and fair view of the terms on which **line function services** and information were supplied in respect of the retailing or generating to which the agreement relates; and
 - (b) this clause was otherwise fully complied with.
- (5) A director breaches this Code if the director—
- (a) refuses or knowingly fails to comply with this clause; or
 - (b) allows a **distributor agreement** or a certificate to be **published** or provided to the **Authority** knowing that it is false or misleading in a material particular.

Compare: 2010 No 116 s 77

Clause 6A.4 Heading: amended, on 1 March 2024, by clause 13(1) of the Electricity Industry Participation Code Amendment (Code Review Programme) 2024.

Clause 6A.4(1), (1)(a)(b) (c) and (d), (2), (3), (4), 4(a) and 5(b): amended, on 1 March 2024, by clause 13 of the Electricity Industry Participation Code Amendment (Code Review Programme) 2024.

6A.5 Person involved in distributor must not pay for transfer of retail customers to connected retailers

- (1) A **distributor**, and any other person listed in subclause (2), must not pay, or offer to

pay, any consideration to a **retailer** in respect of the transfer to a connected retailer of any retail customers who are connected to the **distributor's** networks.

- (2) The persons are—
 - (a) the **distributor** or any other person involved in the **distributor**; and
 - (b) a connected generator in respect of the **distributor** or any other person involved in the connected generator; and
 - (c) a connected retailer in respect of the **distributor** or any other person involved in the connected retailer.
- (3) To avoid doubt, subclause (1) includes a prohibition on—
 - (a) any agreement to acquire the assets or voting securities of another **retailer** (regardless of whether any, or only nominal, consideration is attributed to customers) as a result of which there is a transfer of responsibility for retailing **electricity** to customers; and
 - (b) any consideration that is directly or indirectly or in whole or in part in respect of the transfer of any of another **retailer's** customers or customer accounts.
- (4) A person who knowingly fails to comply with this clause breaches this Code.
- (5) In this clause,—

agreement has the same meaning as in clause 10 of Schedule 2 of the Act

connected generator has the same meaning as in clause 6A.4

connected retailer has the same meaning as in clause 6A.4.

Compare: 2010 No 116 s 78

Clause 6A.5(1), (2)(a), (b) and (c), and (3)(a) and (b): amended, on 1 March 2024, by clause 14 of the Electricity Industry Participation Code Amendment (Code Review Programme) 2024.

6A.6 No discrimination when paying rebates or dividends

- (1) This clause applies if a **distributor** has a connected retailer.
- (2) Every person listed in subclause (3) must ensure that any rebates or dividends or other similar payments paid do not discriminate between—
 - (a) customers of the connected retailer; and
 - (b) customers of other **retailers** where those customers are connected to the **distributor's** networks.
- (3) The persons are—
 - (a) the directors of the **distributor**; and
 - (b) the trustees of any customer trust or community trust that is involved in the **distributor** and the connected retailer; and
 - (c) the directors of any customer co-operative that is involved in the **distributor** and the connected retailer.
- (4) In this clause, **connected retailer** has the same meaning as in clause 6A.4.
- (5) A director or trustee who knowingly fails to comply with this clause breaches this Code.

Compare: 2010 No 116 s 79

Clause 6A.6(1), (2)(b), (3)(a), (b) and (c): amended, on 1 March 2024, by clause 15(1), (2) and (3) of the Electricity Industry Participation Code Amendment (Code Review Programme) 2024.

Disclosure and reporting to Authority

6A.7 Disclosure of information to Authority

- (1) Each director of a **distributor** referred to in clause 6A.4(1) (**distributor agreements**) must ensure that the **distributor** discloses the quantity of **electricity** sold each financial year by connected retailers to customers who are connected to its local network (within the meanings in that clause).
- (2) The disclosure must be made in a statement to the **Authority** within 2 months after the end of the financial year.
- (3) The statement must be in the form prescribed by the **Authority** from time to time.
- (4) The statement must be **published** by the **Authority** and the **distributor**.
- (5) A director breaches this Code if the director—
 - (a) refuses or knowingly fails to comply with this clause; or
 - (b) provides the statement to the **Authority** knowing that it is false or misleading in a material particular.

Compare: 2010 No 116 s 88

Clause 6A.7(1), (2) (3), (4) and (5)(b): amended, on 1 March 2024, by clause 16 of the Electricity Industry Participation Code Amendment (Code Review Programme) 2024.

6A.8 Directors must report compliance with arm's-length rules

- (1) Each director of a business to which the arm's-length rules apply must provide to the **Authority**, no later than 31 March in each year, a statement confirming whether the director has complied with all of the arm's-length rules during the preceding calendar year.
- (2) The directors and the **Authority** must ensure that the statement is **published**.
- (3) A director breaches this Code if the director—
 - (a) refuses or knowingly fails to comply with this clause; or
 - (b) provides the statement to the **Authority** knowing that it is false or misleading in a material particular.

Compare: 2010 No 116 s 89

Clause 6A.8(1), (2) and (3)(b): amended, on 1 March 2024, by clause 17 of the Electricity Industry Participation Code Amendment (Code Review Programme) 2024.

*Part 6A dispensations***6A.9 Authority may grant Part 6A dispensation to specified person**

- (1) A **specified person** may apply to the **Authority** for a **Part 6A dispensation** in respect of their involvement in two or more classes of industry **participant** that are the subject of this Part, or specific provisions of this Part.
- (2) The application must be submitted in the form and by the means specified by the **Authority**.
- (3) Where the **Authority** receives an application under this clause, it may grant a **Part 6A dispensation** to a **specified person** if the **Authority** is satisfied that—
 - (a) it is not necessary, for the purpose of achieving the **Authority's** objectives under section 15 of the **Act**, for the **specified person** to comply with this Part or the specific provisions of this Part; or
 - (b) granting a **Part 6A dispensation** in respect of the **specified person** would better achieve the **Authority's** objectives than requiring compliance.
- (4) The **Authority** must give reasons for its decision under subclause (3).
- (5) The **Authority** may grant a **Part 6A dispensation** on any terms or conditions that it reasonably considers are necessary.
- (6) The **Authority** may amend or revoke a **Part 6A dispensation** granted under subclause (3) by issuing a notice that identifies the **specified person** subject to the **Part 6A dispensation** and gives reasons for the amendment or revocation, but only if the **Authority**—
 - (a) has given notice of the proposed amendment or revocation to the **specified person** subject to the **Part 6A dispensation** and given them a reasonable opportunity to comment; and
 - (b) in relation to an amendment, is satisfied that the amendment is necessary or desirable for the purpose of achieving the **Authority's** objectives in section 15 of the **Act**; and
 - (c) in relation to a revocation, is no longer satisfied of the matters in subclause (3).
- (7) The **Authority** must publish a list of all current **Part 6A dispensations** granted under this clause.

Clause 6A.9: inserted, on 31 August 2023, by clause 5 of the Electricity Industry Participation Code Amendment (Part 6A Dispensation for Specified Persons) 2023.

Clause 6A.9: replaced, on 1 March 2024, by clause 5 of the Electricity Industry Participation Code Amendment (Part 6A Dispensation for Specified Persons) 2024.

Schedule 6A.1

cl 6A.2

Arm's-length rules

1 Objective

- (1) The objective of this schedule is to ensure that businesses to which clause 6A.3 applies operate at arm's-length.
- (2) Without limiting the ordinary meaning of the expression, **arm's-length** includes having relationships, dealings, and transactions that, if the parties were in the position described in subclause (3),—
 - (a) do not include elements that parties in that position would usually omit; and
 - (b) do not omit elements that parties in that position would usually include.
- (3) The position of the parties referred to in subclause (2) is one in which the parties are—
 - (a) connected or related only by the transaction or dealing in question; and
 - (b) acting independently; and
 - (c) each acting in their own best interests.

2 Interpretation

- (1) In this schedule,—

business A means a business that is required to be carried out in one company under clause 6A.3, and **business B** then refers to a business that is required to be carried out in another company under that clause

common parent, in relation to business A and business B, means a person that is involved in both business A and business B

electricity trust means a community trust or a customer trust or a customer co-operative

manager has the meaning given to it by section 5 of the **Act**

parent, in relation to a business, means every person that is involved in the business.
- (2) In this schedule, a person is **interested** in a transaction if the person, or an associate of that person,—
 - (a) is a party to, or will derive a material financial benefit from, the transaction; or
 - (b) has a material financial interest in a party to the transaction; or
 - (c) is a director or manager of a party to, or a person who will or may derive a material financial benefit from, the transaction; or
 - (d) is otherwise directly or indirectly materially interested in the transaction.
- (3) Where this schedule applies to business A, it applies equally to business B, and vice versa.
- (4) References to trust A and trust B have corresponding meanings and application.

3 Arm's-length rules

The arm's-length rules are set out in clauses 3A to 3M.

3A Duty to ensure arm's-length objective is met

Business A and every parent of business A, and business B and every parent of business B, must take all reasonable steps to ensure that the arm's-length objective in clause 1 is met.

3B Arm's-length test

Business A, and every parent of business A, must not enter into a transaction in which business B, or any parent of business B, is interested if the terms of the transaction are terms that unrelated parties in the position of the parties to the transaction, each acting independently and in its own best interests, would not have agreed to.

3C Duty not to prefer interests of business B

A director or manager of business A must not, when exercising powers or performing duties in connection with business A, act in a manner that the director or manager knows or ought reasonably to know would prefer the interests of business B over the interests of business A.

3D Duty not to discriminate in favour of business B

Business A must not, in providing services or benefits, discriminate in favour of business B or the customers, suppliers, or members of business B.

3E Duty to focus on interests of right ultimate owners

A director or manager of business A must, when exercising powers or performing duties in connection with business A, act in the interests of the ultimate members of business A in their capacity as such, and must neither subordinate the interests of those members to the interests of the members of business B nor, to the extent that the members or ultimate beneficial members of each business overlap, take account of that fact or have regard to their dual capacity as members of business B and business A.

3F Duty of directors and managers of parents of business A

A director or manager of a parent of business A must not, when exercising powers or performing duties in connection with business A, act in a manner that the director or manager knows or ought reasonably to know would favour the interests of business B, or of the customers, suppliers, or members of business B in that capacity, over the interests of business A or the customers, suppliers, or members of business A.

3G At least 2 independent directors

At least 2 directors of business A must—

- (a) be neither a director nor a manager of business B; and
- (b) not be an associate of business B, other than by virtue of being a director of business A.

3H No cross-directors who are executive directors

A director of business A may be a director of business B, but must not—

- (a) manage business B on a day-to-day basis; or
- (b) be an associate of business B, other than by virtue of being a director of business A or business B; or
- (c) be involved in business B (other than by having material influence over business B by virtue of being a director of business B).

3I Separate management rule

(1) This clause applies if business A is involved in—

- (a) a generator that has a total capacity of more than 50 MW and that is connected to any of business A's networks; or
- (b) a **retailer** that retails more than 75 GWh of **electricity** in a financial year to customers who are connected to any of business A's networks.

(2) A manager of business A must not—

- (a) be a manager of business B; or
- (b) be an associate of business B, other than by virtue of being a manager of business A; or
- (c) be involved in the business of business B.

3J Directors and managers must not be placed under certain obligations

- (1) Subject to subclause (2), no person may place a director or manager of business A under an obligation, whether enforceable or not, to act in accordance with the directions, instructions, or wishes of business B, or any director or manager or associate of business B, or any parent of business B, and no director or manager may submit to any such obligation.
- (2) A common parent, or a cross-director or a cross-manager, of both business A and business B may place a director or manager under an obligation referred to in subclause (1) if doing so does not contravene another of the arm's-length rules.

3K Restriction on use of information

- (1) Business A must not disclose or permit the disclosure to business B, or use or permit the use for the purposes of business B, of restricted information of business A.
- (2) An electricity trust that is a parent of business A (**trust A**), business A, and every parent of trust A must not disclose or permit the disclosure to business B, an electricity trust that is a parent of business B (**trust B**), or any parent of trust B, or use or permit the use for the purposes of business B or trust B, of restricted information of business A or trust A.
- (3) In this clause, **restricted information** is information received or generated, and held, by business A or trust A that is connected with its business, being information that—
 - (a) is not available to the competitors or potential competitors of business B or trust B; and
 - (b) if disclosed to business B or trust B, would put, or be likely to put, business B or trust B in a position of material advantage in relation to any competitor or potential competitor.
- (4) This clause does not prevent cross-directors under clause 3H from having access to normal board information.

- (5) A manager of business A who is not prohibited from being a manager of business B under clause 3I may use restricted information of both business A and business B, but only to the extent that the use does not contravene another of the arm's-length rules.

3L Records

- (1) Every business to which this schedule applies must keep at its registered office a register of transactions entered into between business A, or any parent of business A, and business B, or any parent of business B.
- (2) Business A must, within 10 working days of entering into such transaction, enter in its register details sufficient to identify the nature and import of the transaction.

3M Practical considerations

- (1) Business A and every parent of business A must ensure that its practical arrangements, such as use of accommodation, equipment, and services, do not contravene this schedule.
- (2) Business A and every parent of business A must ensure that its selection and appointment of advisors does not prejudice compliance with clauses 3G to 3K.

4 Rules do not limit objective

The arm's-length rules in clauses 3A to 3M do not limit the generality of the arm's-length objective in clause 1

Schedule 6A.1 clause 2 definition of **manager**: inserted, on 1 March 2024, by clause 18 of the Electricity Industry Participation Code Amendment (Code Review Programme) 2024.

Schedule 6A.1 clause 3: amended, on 1 March 2024, by clause 19 of the Electricity Industry Participation Code Amendment (Code Review Programme) 2024.

Schedule 6A.1 clause 3A-3M: inserted, on 1 March 2024, by clause 20 of the Electricity Industry Participation Code Amendment (Code Review Programme) 2024.

Schedule 6A.1, clause 4: amended, on 1 March 2024, by clause 21 of the Electricity Industry Participation Code Amendment (Code Review Programme) 2024.

Electricity Industry Participation Code 2010

Part 7 System operator

Contents

- 7.1 Contents of this Part
- 7.1A Reasonable and prudent system operator standard
- 7.2 Principal performance obligations of the system operator in relation to common quality and dispatch
 - 7.2A System operator to maintain frequency
 - 7.2B System operator to restore frequency if frequency fluctuation occurs
 - 7.2C System operator to manage frequency time error
 - 7.2D System operator to identify and resolve problems
 - 7.2E System operator to report on frequency fluctuations
- 7.3 Functions of system operator in relation to security of supply and emergency management
- 7.4 Incorporation of security of supply forecasting and information policy and emergency management policy by reference
- 7.5 *[Revoked]*
- 7.6 *[Revoked]*
- 7.7 System operator and Authority joint development programme
- 7.8 Review of system operator
- 7.9 Additional matters to be taken into account in system operator review
- 7.10 Separation of Transpower roles
- 7.11 Review of performance of the system operator
- 7.12 Authority must publish system operator reports

Amending or replacing system operation documents

- 7.13 Proposals to amend system operation documents
 - 7.14 Process where participants request amendments
 - 7.15 Review of policy statement and procurement plan
 - 7.16 Authority must consent to consultation before system operator consults on proposal to amend system operation document
 - 7.17 Authority direction to system operator
 - 7.18 Process if the Authority does not approve a proposal for consultation
 - 7.19 Effect of Authority's and system operator decisions under clauses 7.16 to 7.18
 - 7.20 Consultation on proposed amendments
 - 7.21 Approval of system operation documents
 - 7.22 Authority may prescribe timeframes
-

7.1 Contents of this Part

This Part provides for—

- (aa) a reasonable and prudent **system operator** standard; and
- (a) high level, output focussed performance obligations of the **system operator** in relation to the real time co-ordination and delivery of **common quality and dispatch**; and
- (b) the functions of the **system operator** in relation to **demand** and supply forecasting, security of supply, and supply emergencies; and
- (c) review of the **system operator's** performance under the **Act**, this Code, and the relevant **market operation service provider agreement**; and
- (d) requirements for the amendment or replacement of **system operation documents**.

Clause 7.1(aa): inserted, on 19 May 2016, by clause 7(1) of the Electricity Industry Participation Code Amendment (System Operator and Alignment with Statutory Objective) 2016.

Clause 7.1(a): amended, on 19 May 2016, by clause 7(2) of the Electricity Industry Participation Code Amendment (System Operator and Alignment with Statutory Objective) 2016.

Clause 7.1(b): amended, on 19 May 2016, by clause 7(3) of the Electricity Industry Participation Code Amendment (System Operator and Alignment with Statutory Objective) 2016.

Clause 7.1(c): amended, on 19 May 2016, by clause 7(4) of the Electricity Industry Participation Code Amendment (System Operator and Alignment with Statutory Objective) 2016.

Clause 7.1(c): amended, on 1 August 2023, by clause 5(1) of the Electricity Industry Participation Code Amendment (System Operation Documents) 2023.

Clause 7.1(d): inserted, on 1 August 2023, by clause 5(2) of the Electricity Industry Participation Code Amendment (System Operation Documents) 2023.

7.1A Reasonable and prudent system operator standard

- (1) The **system operator** must carry out its obligations under this Code with skill, diligence, prudence, foresight, good economic management, and in accordance with recognised international good practice, taking into account—
 - (a) the circumstances in New Zealand; and
 - (b) the fact that real-time co-ordination of the power system involves complex judgements and inter-related events.
- (2) The **system operator** does not breach a **principal performance obligation** or clause 8.5 of this Code if the **system operator** complies with subclause (1).

Clause 7.1A: inserted, on 19 May 2016, by clause 8 of the Electricity Industry Participation Code Amendment (System Operator and Alignment with Statutory Objective) 2016.

7.2 Principal performance obligations of the system operator in relation to common quality and dispatch

The obligations in clauses 7.2A to 7.2D are **principal performance obligations**.

Clause 7.2: amended, on 19 May 2016, by clause 9 of the Electricity Industry Participation Code Amendment (System Operator and Alignment with Statutory Objective) 2016.

7.2A System operator to maintain frequency

- (1) The **system operator** must **dispatch assets** made available in a manner that avoids cascade failure of **assets** resulting in a loss of **electricity** to **consumers** arising from—
 - (a) a frequency or voltage excursion; or
 - (b) a **supply** and **demand** imbalance.
- (2) Except as provided in this clause and clause 7.2B, the **system operator** must maintain frequency in the **normal band**.

- (3) The **system operator** must ensure that the scheduling, pricing, and dispatch tool has the information necessary to schedule a minimum quantity of **instantaneous reserve**.
- (4) Subject to the availability of **offers** or **reserve offers**, the **system operator** must schedule sufficient **instantaneous reserve** to meet the **system operator's** obligations in subclauses (5) to (7).
- (5) During a contingent event, the **system operator** must ensure that, for the **island** in which the contingent event takes place—
 - (a) frequency remains at or above 48 Hertz; and
 - (b) frequency returns to or above 49.25 Hertz within 60 seconds after the contingent event.
- (6) During an extended contingent event in the North Island, the **system operator** must ensure that, for that **island**—
 - (a) frequency remains at or above 47 Hertz; and
 - (b) frequency does not drop to or below 47.1 Hertz for longer than 5 seconds; and
 - (c) frequency does not drop to or below 47.3 Hertz for longer than 20 seconds; and
 - (d) frequency returns to or above 49.25 Hertz within 60 seconds after the extended contingent event.
- (7) During an extended contingent event in the South Island, the **system operator** must ensure that, for that **island**—
 - (a) frequency remains at or above 45 Hertz; and
 - (b) frequency returns to or above 49.25 Hertz within 60 seconds after the extended contingent event.

7.2B System operator to restore frequency if frequency fluctuation occurs

If a **frequency fluctuation** occurs, the **system operator** must ensure that frequency is restored to the **normal band** as soon as reasonably practicable having regard to all circumstances surrounding the **frequency fluctuation**.

7.2C System operator to manage frequency time error

- (1) The **system operator** must ensure that any deviations from **New Zealand standard time** in the power system, caused by variations in system frequency, do not exceed 5 seconds.
- (2) At least once in each day, the **system operator** must eliminate from the power system any deviations from **New Zealand standard time** caused by variations in system frequency.

7.2D System operator to identify and resolve problems

- (1) A **participant** may request that the **system operator** investigate and resolve a security of supply or reliability problem arising from non-compliance with a standard in clause 4.7, 4.8, or 4.9 of the **Connection Code**, at any **point of connection** to the **grid**.
- (2) If the **system operator** receives a reasonable request under subclause (1), the **system operator** must, given the **assets** made available to it at the relevant time—
 - (a) identify whether there is a security of supply or reliability problem arising from non-compliance with a standard in clause 4.7, 4.8, or 4.9 of the **Connection**

Code, at any **point of connection** to the **grid**; and

- (b) if there is such a problem—
- (i) identify the cause of the problem; and
 - (ii) resolve the problem to the extent reasonable and practical.

7.2E System operator to report on frequency fluctuations

- (1) By the 10th **business day** of each month (except by the 20th **business day** in the month of January), the **system operator** must report to the **Authority** the number of **frequency fluctuations** in each of the following frequency bands, in each **island** in the previous month:

Frequency band (Hertz) (where "x" is the maximum or minimum frequency during a frequency fluctuation)			
52.00	>	x	≥ 51.25
51.25	>	x	≥ 50.50
49.50	>	x	≥ 48.75
48.75	>	x	≥ 48.00
48.00	>	x	≥ 47.00

- (2) By the 10th **business day** of each month (except by the 20th **business day** in the month of January), the **system operator** must report to the **Authority** the number of **frequency fluctuations** in each of the following frequency bands, in the South Island in the previous month:

Frequency band (Hertz) (where "x" is the maximum or minimum frequency during a frequency fluctuation)			
55.00	>	x	≥ 53.75
53.75	>	x	≥ 52.00
47.00	>	x	≥ 45.00

Compare: Electricity Governance Rules 2003 rules 2 and 3 section II part C
 Clauses 7.2A-E: inserted, on 19 May 2016, by clause 10 of the Electricity Industry Participation Code Amendment (System Operator and Alignment with Statutory Objective) 2016.
 Clause 7.2E: amended, on 5 October 2017, by clause 77 of the Electricity Industry Participation Code Amendment (Code Review Programme) 2017.

7.3 Functions of system operator in relation to security of supply and emergency management

- (1) The **system operator** must—
 - (a) prepare and **publish** a **security of supply forecasting and information policy** that includes a requirement that the **system operator**—
 - (i) prepare and **publish** at least annually a security of supply assessment that contains detailed supply and demand forecasts for at least 5 years, which assists interested parties to assess whether the energy security of supply standard and the capacity security of supply standard set out in subclause (2) are likely to be met; and
 - (ii) consult with persons that the **system operator** thinks are representative of the interests of persons likely to be substantially affected by a security of supply assessment prepared under subparagraph (i) before **publishing** such an assessment; and
 - (iii) prepare and **publish** information that assists interested parties to monitor how hydro and thermal generating capacity, transmission assets, primary fuel, and **ancillary services** are being utilised to manage risks of shortage, including extended dry periods; and
 - (iv) **publish**, in relation to the information **published** under subparagraphs (i) and (iii), sufficient details of the modelling data, assumptions, and methodologies that the **system operator** has used to prepare that information as to allow interested parties to recreate that information (but without **publishing** information that is confidential to any **participant**); and
 - (b) implement and comply with the **security of supply forecasting and information policy** prepared and **published** in accordance with paragraph (a).
- (2) For the purposes of subclause (1)(a)(i)—
 - (a) the energy security of supply standard is a **winter energy margin** of 14-16% for New Zealand and a **winter energy margin** of 25.5-30% for the South Island; and
 - (b) the capacity security of supply standard is a **winter capacity margin** of 630-780 **MW** for the North Island.
- (2A) The **Authority** may **publish** a security standards assumptions document.
- (2B) Subject to subclauses (2C) and (2D), if the **Authority** has **published** a security standards assumptions document under subclause (2A), the **system operator** must use the assumptions set out in that document in preparing a security of supply assessment under the **security of supply forecasting and information policy**.
- (2C) The **system operator** may use different assumptions from those in a security standards assumptions document to prepare a security of supply assessment if—
 - (a) the **system operator** considers that there are good reasons to use different assumptions; and
 - (b) the **system operator** includes in the security of supply assessment—
 - (i) a detailed explanation of the assumptions used to prepare the security of supply assessment; and
 - (ii) a statement of reasons for using those assumptions instead of the assumptions **published** by the **Authority**; and
 - (iii) a description of how the security of supply assessment prepared using those assumptions differs from a security of supply assessment prepared using the

- assumptions set out in the security standards assumptions document.
- (2D) Despite subclause (2C), the **system operator** is not required to include the information referred to in subclause (2C)(b) in a security of supply assessment if the **system operator** considers that it would have good reason to refuse to supply the information under clause 2.6.
- (3) The **system operator** must —
- (a) prepare and **publish** an **emergency management policy** that sets out the steps that the **system operator** must take, and must encourage **participants** to take, at various stages during an extended emergency such as an extended dry sequence or an extended period of capacity inadequacy; and
 - (b) include in the **emergency management policy** the steps that, at various stages in anticipation of and during a gas transmission failure or gas supply failure to **generators**, the **system operator** must—
 - (i) take as the **system operator**; and
 - (ii) encourage **participants** to take, including, if appropriate, steps for relevant **participants** to take in conjunction with gas industry entities; and
 - (iii) encourage relevant gas industry entities to take; and
 - (c) implement and comply with the **emergency management policy** .
- (4) The **emergency management policy** is not required to include information that is already set out in—
- (a) the **system operator rolling outage plan** prepared under subpart 1 of Part 9; or
 - (b) the **policy statement**; or
 - (c) **Technical Code B** of Schedule 8.3.
- (5) The **system operator** may depart from the policies set out in an **emergency management policy** if an **EMP departure situation** arises and such departure is required to enable the **system operator** to comply with clause 7.1A(1).
- (6) If the **system operator** makes a departure under subclause (5), the **system operator** must provide a report to the **Authority** setting out the circumstances of the **EMP departure situation** and the actions taken to deal with it. The **Authority** must **publish** the report within a reasonable time of its receipt.

Heading: amended, on 5 October 2017, by clause 78(1) of the Electricity Industry Participation Code Amendment (Code Review Programme) 2017.

Clause 7.3(1): amended, on 19 May 2016, by clause 11(1) of the Electricity Industry Participation Code Amendment (System Operator and Alignment with Statutory Objective) 2016.

Clause 7.3(1)(a): amended, on 19 May 2016, by clause 11(2) of the Electricity Industry Participation Code Amendment (System Operator and Alignment with Statutory Objective) 2016.

Clause 7.3(1)(a)(iv): amended, on 5 October 2017, by clause 78(2) of the Electricity Industry Participation Code Amendment (Code Review Programme) 2017.

Clause 7.3(1)(b): amended, on 19 May 2016, by clause 11(3) of the Electricity Industry Participation Code Amendment (System Operator and Alignment with Statutory Objective) 2016.

Clause 7.3(2)(a): amended, on 3 January 2013, by clause 4(1) of the Electricity Industry Participation (Supply Standards) Code Amendment 2012.

Clause 7.3(2)(b): amended, on 3 January 2013, by clause 4(2) of the Electricity Industry Participation (Supply Standards) Code Amendment 2012.

Clause 7.3(2A), (2B), (2C) and (2D): inserted, on 3 January 2013, by clause 4(3) of the Electricity Industry Participation (Supply Standards) Code Amendment 2012.

Clause 7.3(2A): amended, on 5 October 2017, by clause 78(3) of the Electricity Industry Participation Code Amendment (Code Review Programme) 2017.

Clause 7.3(2B): amended, on 19 May 2016, by clause 11(4) of the Electricity Industry Participation Code Amendment (System Operator and Alignment with Statutory Objective) 2016.

Clause 7.3(2B): amended, on 5 October 2017, by clause 78(4) of the Electricity Industry Participation Code Amendment (Code Review Programme) 2017.

Clause 7.3(2C)(b)(ii): amended, on 5 October 2017, by clause 78(5) of the Electricity Industry Participation Code Amendment (Code Review Programme) 2017.

Clause 7.3(3): amended, on 19 May 2016, by clause 11(5) of the Electricity Industry Participation Code Amendment (System Operator and Alignment with Statutory Objective) 2016.

Clause 7.3(3)(a): amended, on 19 May 2016, by clause 11(6)(a) and (b) of the Electricity Industry Participation Code Amendment (System Operator and Alignment with Statutory Objective) 2016.

Clause 7.3(3)(b): amended, on 19 May 2016, by clause 11(7) of the Electricity Industry Participation Code Amendment (System Operator and Alignment with Statutory Objective) 2016.

Clause 7.3(3)(b)(i): amended, on 19 May 2016, by clause 11(8) of the Electricity Industry Participation Code Amendment (System Operator and Alignment with Statutory Objective) 2016.

Clause 7.3(3)(b)(ii): amended, on 19 May 2016, by clause 11(9) of the Electricity Industry Participation Code Amendment (System Operator and Alignment with Statutory Objective) 2016.

Clause 7.3(3)(c): amended, on 19 May 2016, by clause 11(10) of the Electricity Industry Participation Code Amendment (System Operator and Alignment with Statutory Objective) 2016.

Clause 7.3(4)(b): amended, on 10 January 2013, by clause 5 of the Electricity Industry Participation (Policy Statement and Procurement Plan Review Process) Code Amendment 2012.

Clause 7.3(5): amended, on 21 September 2012, by clause 7(1) of the Electricity Industry Participation (Minor Amendments) Code Amendment 2012.

Clause 7.3(5): amended, on 19 May 2016, by clause 11(11) of the Electricity Industry Participation Code Amendment (System Operator and Alignment with Statutory Objective) 2016.

Clause 7.3(6): amended, on 21 September 2012, by clause 7(2) of the Electricity Industry Participation (Minor Amendments) Code Amendment 2012.

Clause 7.3(6): amended, on 19 May 2016, by clause 11(12) of the Electricity Industry Participation Code Amendment (System Operator and Alignment with Statutory Objective) 2016.

7.4 Incorporation of security of supply forecasting and information policy and emergency management policy by reference

- (1) **The security of supply forecasting and information policy and the emergency management policy** are incorporated by reference in this Code.
- (2) Clauses 7.13 to 7.22 apply to any amendment or replacement of the **security of supply forecasting and information policy or emergency management policy**.

Clause 7.4(1): amended, on 5 October 2017, by clause 79 of the Electricity Industry Participation Code Amendment (Code Review Programme) 2017.

Clause 7.4(1): amended, on 1 August 2023, by clause 6(1) of the Electricity Industry Participation Code Amendment (System Operation Documents) 2023.

Clause 7.4(2): replaced, on 1 August 2023, by clause 6(2) of the Electricity Industry Participation Code Amendment (System Operation Documents) 2023.

Clause 7.4(2): amended, on 1 March 2024, by clause 22 of the Electricity Industry Participation Code Amendment (Code Review Programme) 2024.

7.5 [Revoked]

Clause 7.5(2): revoked, on 19 May 2016, by clause 12 of the Electricity Industry Participation Code Amendment (System Operator and Alignment with Statutory Objective) 2016.

Clause 7.5(7): amended, on 1 November 2018, by clause 10(a) of the Electricity Industry Participation Code Amendment (Code Review Programme) 2017.

Clause 7.5(8): amended, on 1 November 2018, by clause 10(b) of the Electricity Industry Participation Code Amendment (Code Review Programme) 2017.

Clause 7.5: revoked, on 1 August 2023, by clause 7 of the Electricity Industry Participation Code Amendment (System Operation Documents) 2023.

7.6 [Revoked]

Clause 7.6: revoked, on 1 August 2023, by clause 8 of the Electricity Industry Participation Code Amendment (System Operation Documents) 2023.

7.7 System operator and Authority joint development programme

- (1) At least annually, the **system operator** and the **Authority** must agree a development

programme that coordinates and prioritises—

- (a) those items in the **Authority's** industry development work plan on which the **Authority** intends to liaise with the **system operator**; and
 - (b) the **system operator's** capital expenditure plan provided to the **Authority** under the **system operator market operation service provider agreement**.
- (2) The **Authority** must **publish** the programme agreed under subclause (1).

7.8 Review of system operator

- (1) The **Authority** must review the performance of the **system operator** at least once in each year ending 30 June, after the **system operator** submits its self-review under clause 7.11.
- (2) The review must concentrate on the **system operator's** compliance with—
- (a) its obligations under this Code and the **Act**; and
 - (b) the operation of this Code and the **Act**; and
 - (c) any performance standards agreed between the **system operator** and the **Authority**; and
 - (d) the provisions of the **system operator's market operation service provider agreement**.
- (3) The **Authority** must **publish** a report on the performance of the **system operator** no later than 10 **business days** after the **Authority** completes its review.

Compare: SR 2003/374 r 47

Clause 7.8(1): amended, on 19 May 2016, by clause 13(1) of the Electricity Industry Participation Code Amendment (System Operator and Alignment with Statutory Objective) 2016.

Clause 7.8(1): amended, on 5 October 2017, by clause 80(1) of the Electricity Industry Participation Code Amendment (Code Review Programme) 2017.

Clause 7.8(3): inserted, on 19 May 2016, by clause 13(2) of the Electricity Industry Participation Code Amendment (System Operator and Alignment with Statutory Objective) 2016.

Clause 7.8(3): amended, on 5 October 2017, by clause 80(2) of the Electricity Industry Participation Code Amendment (Code Review Programme) 2017.

7.9 Additional matters to be taken into account in system operator review

The **Authority** must take into account the following matters when conducting a review under clause 7.8:

- (a) the terms of the **system operator's market operation service provider agreement**;
- (b) reports from the **system operator** to the **Authority**, including the **system operator's** self-review under clause 7.11;
- (c) the performance of the **system operator** over time in relation to this Part and Part 8;
- (d) the extent to which the acts or omissions of other persons have impacted on the performance of the **system operator** and the nature of the task being monitored;
- (e) reports or complaints from any person, and any responses by the **system operator** to such reports or complaints;
- (f) the fact that the real time co-ordination of the power system involves a number of complex judgments and inter-related incidents;
- (g) any disparity of information between the **Authority** and the **system operator**;
- (h) any other matter the **Authority** considers relevant to assess the **system operator's**

performance.

Compare: SR 2003/374 r 48

Clause 7.9(b): amended, on 19 May 2016, by clause 14(1) of the Electricity Industry Participation Code Amendment (System Operator and Alignment with Statutory Objective) 2016.

Clause 7.9(e): amended, on 19 May 2016, by clause 14(2) of the Electricity Industry Participation Code Amendment (System Operator and Alignment with Statutory Objective) 2016.

7.10 Separation of Transpower roles

- (1) **Transpower's** role as **system operator** under this Code and the **Act** is distinct and separate from any other role or capacity that **Transpower** may have under this Code and the **Act**, including as a **grid owner** or transmission provider.
- (2) For this purpose, when assessing an aspect of the performance, or non-performance, of the **system operator**,—
 - (a) the assessment must be made on the basis that the **system operator** had no other role or capacity; and
 - (b) the **system operator** must be treated as if it did not have any knowledge or information that may be received or held by **Transpower** unless **Transpower** receives or holds that information or knowledge in its capacity as **system operator**.
- (3) Subclause (2) applies, with necessary modifications, to an assessment of an aspect of the performance, or non-performance, of **Transpower** in any other role or capacity under this Code or the **Act**.
- (4) **Transpower** must report, in each self-review report provided under this Code, on the extent to which its role as **system operator** under this Code and the **Act** has, despite subclauses (1) to (3), been materially affected by—
 - (a) any other role or capacity that **Transpower** has under this Code or the **Act**; or
 - (b) an agreement.

Compare: SR 2003/374 r 50

7.11 Review of performance of the system operator

- (1) No later than 31 August in each year, the **system operator** must submit to the **Authority** a review and assessment of its performance in the previous 12 month period ending 30 June.
- (2) The self-review must contain such information as the **Authority** may reasonably require from time to time to enable the **Authority** to review the **system operator's** performance during the period in relation to the following:
 - (a) the **policy statement**;
 - (b) the **security of supply forecasting and information policy**;
 - (c) the **emergency management policy**;
 - (d) the joint development programme prepared under clause 7.7(1);
 - (e) the work programmes agreed with the **Authority** under the **system operator's market operation service provider agreement**;
 - (f) the **system operator's** engagement with **participants**;
 - (g) delivery of the **system operator's** capital and business plans;
 - (h) the financial and operational performance of the **system operator**.
- (3) *[Revoked]*

(4) *[Revoked]*

Compare: Electricity Governance Rules rule 14 section II part C

Clause 7.11(1): amended, on 19 May 2016, by clause 15(1)(a) and (b) of the Electricity Industry Participation Code Amendment (System Operator and Alignment with Statutory Objective) 2016.

Clause 7.11(2): amended, on 19 May 2016, by clause 15(2) of the Electricity Industry Participation Code Amendment (System Operator and Alignment with Statutory Objective) 2016.

Clause 7.11(3) and (4): revoked, on 19 May 2016, by clause 15(3) of the Electricity Industry Participation Code Amendment (System Operator and Alignment with Statutory Objective) 2016.

Clause 7.11(4): amended, on 15 May 2014, by clause 6 of the Electricity Industry Participation (Minor Code Amendments) Code Amendment 2014.

7.12 Authority must publish system operator reports

(1) The **Authority** must **publish** all self-review reports that are received from the **system operator** and that are required to be provided by the **system operator** to the **Authority** under this Code.

(2) The **Authority** must **publish** each report within **5 business days** after receiving the report.

Compare: SR 2003/374 r 49

Clause 7.12: amended, on 5 October 2017, by clause 81 of the Electricity Industry Participation Code Amendment (Code Review Programme) 2017.

Amending or replacing system operation documents

Cross heading: inserted, on 1 August 2023, by clause 9 of the Electricity Industry Participation Code Amendment (System Operation Documents) 2023.

7.13 Proposals to amend system operation documents

(1) A proposal to amend a **system operation document** is made by the **system operator** to the **Authority**.

(2) The process for the **system operator** to develop a proposal may be initiated by—

(a) the **Authority** directing the **system operator** to consider a proposal to amend a **system operation document**; or

(b) the **system operator** agreeing under clause 7.14 to progress an amendment to a system operation document; or

(c) the **system operator** deciding to progress an amendment, either—

(i) at the conclusion of a review carried out under clause 7.15; or

(ii) at any other time.

(3) Before providing a proposal to the **Authority** to amend a **system operation document**, the **system operator** must consult on the proposal where required by clause 7.20, after obtaining consent as required by clause 7.16.

(4) For the purposes of clauses 7.13 to 7.22, a proposal to amend a **system operation document** includes a proposal to replace a **system operation document**.

Clause 7.13: inserted, on 1 August 2023, by clause 9 of the Electricity Industry Participation Code Amendment (System Operation Documents) 2023.

7.14 Process where participants request amendments

(1) If a **participant** requests an amendment to a **system operation document** to the **system operator**, the **system operator** must decide to—

(a) consider the amendment as part of the next review under clause 7.15; or

(b) consider the amendment outside of a review; or

(c) decline to consider the amendment.

- (2) The **system operator** must advise the **Authority** and the **participant** that requested the amendment of its decision, including its reasons, within 1 month of receiving the request.

Clause 7.14: inserted, on 1 August 2023, by clause 9 of the Electricity Industry Participation Code Amendment (System Operation Documents) 2023.

7.15 Review of policy statement and procurement plan

- (1) The **system operator** must review the **policy statement** and the **procurement plan** at least once every 2 years to identify whether the document should be amended.
- (2) For the purposes of subclause (1), any 2 year period commences on either—
- (a) the date the last review of the document was completed if that review did not result in an amendment being made; or
 - (b) if a review results in an amendment being made, the date the amendment takes legal effect.
- (3) At the conclusion of a review the **system operator** must either—
- (a) propose an amendment to the **Authority**, following consultation where required by clause 7.20, after obtaining consent as required by clause 7.16; or
 - (b) advise the **Authority** that the **system operator** does not consider that an amendment is required and provide the **Authority** with a written report describing the process carried out for the review, the **system operator's** decision, and the reasons for the decision.

Clause 7.15: inserted, on 1 August 2023, by clause 9 of the Electricity Industry Participation Code Amendment (System Operation Documents) 2023.

7.16 Authority must consent to consultation before system operator consults on proposal to amend system operation document

- (1) The **system operator** must obtain the **Authority's** consent before consulting on a proposal to amend a **system operation document**.
- (2) The purpose for the **Authority** consenting to consultation is to enable the **Authority** to identify to the **system operator** any issues with—
- (a) the proposal that may cause the **Authority** to not issue a notice to adopt the amendment under section 131B(2) of the **Act** or to not progress the amendment as a **Code** amendment under section 38 of the **Act**, as the case may be; and
 - (b) the **system operator's** proposed consultation process and the information to be provided with the proposal for consultation under clause 7.20(2)(a).
- (3) When requesting the **Authority's** consent, the system operator must provide the following information to the **Authority**:
- (a) the consultation information in clause 7.20(2)(a);
 - (b) the proposed consultation period in clause 7.20(2)(b);
 - (c) the **system operator's** proposed consultation process;
 - (d) a list of the persons the **system operator** proposes to consult with.
- (4) The **Authority** must within a reasonable period time after receiving the **system operator's** request for consent either—
- (a) consent to the consultation and notify the **system operator** accordingly; or
 - (b) raise any issues it has identified under subclause (2) with the **system operator**.

Clause 7.16: inserted, on 1 August 2023, by clause 9 of the Electricity Industry Participation Code Amendment (System Operation Documents) 2023.

Clause 7.16(4)(b): amended, on 1 March 2024, by clause 23 of the Electricity Industry Participation Code Amendment (Code Review Programme) 2024.

7.17 Authority direction to system operator

- (1) In addition to its powers under clause 7.16, the **Authority** may direct the **system operator** to make changes to any of the matters listed in clause 7.16(3), other than the proposed amendment itself.
- (2) The **Authority** may not give a direction under subclause (1) if the effect of the direction is that the proposal, if finally made, could not be considered to have been made by the **system operator** for the purposes of section 131B(2) of the **Act**.

Clause 7.17: inserted, on 1 August 2023, by clause 9 of the Electricity Industry Participation Code Amendment (System Operation Documents) 2023.

7.18 Process if the Authority does not approve a proposal for consultation

- (1) If the **Authority** identifies any issues or concerns under clause 7.16(2)(a), unless the **Authority** has given a direction under clause 7.17(1), the **system operator** must consider those issues and either—
 - (a) amend the proposal, proposed consultation process or the consultation information to be provided with the proposal and re-submit the information required under clause 7.16(3) to the **Authority** for approval; or
 - (b) decide not to continue with the proposal; or
 - (c) continue with the proposal without making any amendment to it, the proposed consultation process or the information to be provided with the proposal.
- (2) If the **Authority** directs the **system operator** under clause 7.17(1), the **system operator** must make the change and re-submit the information required under clause 7.16(3) to the **Authority** for approval.
- (3) If the **system operator** re-submits the information required under clause 7.16(3) to the **Authority**, the **Authority** must re-consider the information and decide either to:
 - (a) consent to the consultation; or
 - (b) not consent to the consultation.
- (4) If the **Authority** does not consent to a proposal for consultation under subclause (3), the **system operator** must decide either—
 - (a) to not continue with the proposal; or
 - (b) to continue with the proposal.
- (5) The **system operator** and the **Authority** must give each other notice of their decisions and the reasons for the decision under the above subclauses.

Clause 7.18: inserted, on 1 August 2023, by clause 9 of the Electricity Industry Participation Code Amendment (System Operation Documents) 2023.

7.19 Effect of Authority's and system operator decisions under clauses 7.16 to 7.18

- (1) The **Authority's** consent to consultation under clause 7.16(4)(a) or 7.18(3)(a) or to direct the **system operator** under clause 7.17(1) does not affect the **Authority's** decision regarding approval of a **system operation document** under clause 7.21.
- (2) If the **system operator** continues with a proposal under clauses 7.18(1)(c) or 7.18(4)(b), the **system operator**:
 - (a) does so with the risk that the **Authority** may decide not to issue a notice to adopt the amendment under section 131B(2) of the **Act** or to not progress the amendment as a Code amendment under section 38 of the **Act**; and
 - (b) must advise the persons it consults with under clause 7.20 that the **Authority** has not consented to the consultation and that the risk described in paragraph (a) arises.

- (3) Subclause (2)(a) does not prevent the **Authority** from deciding to not issue a notice to adopt an amendment under section 131B(2) of the **Act** or to not progress the amendment as a Code amendment under section 38 of the **Act**.

Clause 7.19: inserted, on 1 August 2023, by clause 9 of the Electricity Industry Participation Code Amendment (System Operation Documents) 2023.

Clause 7.19(1): amended, on 1 March 2024, by clause 24(1) of the Electricity Industry Participation Code Amendment (Code Review Programme) 2024.

Clause 7.19(2)(a) and (3): amended, on 1 March 2024, by clause 24(2) of the Electricity Industry Participation Code Amendment (Code Review Programme) 2024.

Clause 7.19(2)(b): amended, on 1 March 2024, by clause 24(3) of the Electricity Industry Participation Code Amendment (Code Review Programme) 2024.

7.20 Consultation on proposed amendments

- (1) The **system operator** must consult on any proposed amendment of a **system operation document** with affected **participants** or persons that represent the interests of those persons likely to be affected by the proposed amendment.
- (2) The **system operator** must, at least, carry out the following steps as part of consultation on a proposed amendment:
- (a) make the following information available to the persons it is consulting with:
 - (i) a draft of the proposed amendment:
 - (ii) a statement of the objectives of the proposed amendment:
 - (iii) an evaluation of the costs and benefits of the proposed amendment:
 - (iv) an evaluation of alternative means of achieving the objectives of the proposed amendment (if any):
 - (b) provide a reasonable period of time to the persons it is consulting with to consider the information provided under paragraph (a) and to make submissions:
 - (c) consider any submissions.
- (3) In evaluating the costs and benefits of a proposed amendment under subclause (2)(a)(iii), the **system operator** must undertake a quantitative assessment, if reasonably possible.
- (4) The **system operator** must provide a copy of each submission received under subclause (2) to the **Authority**.
- (5) Despite subclause (1), consultation is not required if the **system operator** satisfies the **Authority**, on reasonable grounds, that—
- (a) the nature of the amendment is technical and non-controversial; or
 - (b) there is widespread support for the amendment among the persons likely to be affected by it; or
 - (c) there has been adequate prior consultation so that all relevant views have been considered; or
 - (d) it is necessary or desirable in the public interest that the proposed amendment be made urgently.

Clause 7.20: inserted, on 1 August 2023, by clause 9 of the Electricity Industry Participation Code Amendment (System Operation Documents) 2023.

7.21 Approval of system operation documents

- (1) Following consultation, or if clause 7.20(5) applies, the **system operator** must provide the **Authority** with a report that sets out the following:
- (a) the information required by clause 7.20(2)(a), regardless of whether or not consultation was carried out, but incorporating any changes made following consultation:

- (b) a summary of any submissions received and the **system operator's** response to each;
 - (c) a list of any changes made to the proposed amendments to the **system operation document** after consultation and the reasons for the changes;
 - (d) if clause 7.20(5) applies, the reasons why the **system operator** considered that consultation was not required;
 - (e) a final draft of the proposed amendments to the **system operation document** (either as amendments to the **system operation document** or a replacement **system operation document**).
- (2) After receipt of the report, the **Authority** may—
- (a) approve the proposed amendments to the **system operation document**; or
 - (b) require the **system operator** to conduct further consultation before re-submitting the proposed amendments to the **system operation document** to the **Authority** for approval; or
 - (c) decline to approve the proposed amendments to the **system operation document**.
- (3) The approval by the **Authority** of proposed amendments to a **system operation document**—
- (a) does not remove the requirement for the **Authority** to comply with either section 38 or section 131B of the **Act** in order to give legal effect to the amendments as part of the **Code**; and
 - (b) does not affect, pre-determine or otherwise override any decision by the **Authority** under section 38 or section 131B of the **Act**.
- (4) To avoid doubt, an approved **system operation document** is not invalid only because the **Authority** and the **system operator** did all or any of the things referred to in clauses 7.16 to 7.20 before those clauses came into force.

Clause 7.21: inserted, on 1 August 2023, by clause 9 of the Electricity Industry Participation Code Amendment (System Operation Documents) 2023.

Clause 7.21(1) and (1)(d): amended, on 1 March 2024, by clause 25 of the Electricity Industry Participation Code Amendment (Code Review Programme) 2024.

7.22 Authority may prescribe timeframes

From time to time the **Authority** may prescribe reasonable timeframes that the **system operator** must comply with in completing any steps in clauses 7.16 to 7.21.

Clause 7.22: inserted, on 1 August 2023, by clause 9 of the Electricity Industry Participation Code Amendment (System Operation Documents) 2023.

Electricity Industry Participation Code 2010

Part 8 Common quality

Contents

- 8.1 Contents of this Part
- 8.1A *[Revoked]*
 - Subpart 1—Performance obligations of the system operator
- 8.2 Contents of this subpart
- 8.3 Recovery of costs from causers of voltage non-compliance
- 8.4 System operator may rely on information provided
- 8.5 Restoration
- 8.6 System operator may contract for higher levels of common quality
- 8.7 System operator must not contract contrary to this arrangement
- Policy statement*
- 8.8 System operator to comply with policy statement
- 8.9 *[Revoked]*
- 8.10 Incorporation of policy statement by reference
- 8.10A *[Revoked]*
- 8.10B *[Revoked]*
- 8.10C *[Revoked]*
- 8.11 Content of policy statement
- 8.11A *[Revoked]*
- 8.12 *[Revoked]*
- 8.12A *[Revoked]*
- 8.12B *[Revoked]*
- 8.13 *[Revoked]*
- 8.14 Departure from policy statement
- System security forecast*
- 8.15 System operator to prepare and review system security forecast
 - Subpart 2—Asset owner performance obligations and technical standards
- 8.16 Contents of this subpart
 - Asset owner performance obligations and technical standards concerning frequency*
 - 8.17 Contribution by injections to overall frequency management
 - 8.18 Contributions by purchasers to overall frequency management
 - 8.19 Contributions to frequency support in under-frequency events
 - 8.20 Contributions by grid owners to frequency support
 - 8.21 Excluded generating stations
 - Asset owner performance obligations and technical standards concerning voltage*
 - 8.22 Voltage range AOPOs
 - 8.23 Voltage support AOPOs
 - 8.24 Load shedding obligations to support voltage
 - 8.25 Other asset owner performance obligations and technical standards
 - 8.25A Fault ride through
 - 8.25B Reactive current and active power output

- 8.25C Use of additional equipment
- 8.25D Application
- 8.26 Asset owners must co-operate

Compliance

- 8.27 System operator to monitor compliance
- 8.28 Responsibility for compliance

Equivalence arrangements and dispensations

- 8.29 Right to apply for approval of equivalence arrangement or grant of dispensation
- 8.30 Approval of equivalence arrangements
- 8.31 Grant of dispensations
- 8.32 Liability of asset owner pending decision
- 8.33 Modification of equivalence arrangement or dispensation
- 8.34 Cancellation of equivalence arrangement or dispensation
- 8.35 Revocation of equivalence arrangement and revocation or variation of dispensation
- 8.36 Appeal against decisions
- 8.37 Other provisions relating to equivalence arrangements and dispensations
- 8.38 Authority may require excluded generating stations to comply with certain clauses

Subpart 3—Arrangements concerning ancillary services

- 8.39 Contents of this subpart

Procurement plan

- 8.40 System operator to use reasonable endeavours to implement and comply with procurement plan
- 8.41 *[Revoked]*
- 8.42 Incorporation of procurement plan by reference
- 8.42A *[Revoked]*
- 8.42B *[Revoked]*
- 8.42C *[Revoked]*
- 8.43 Content of procurement plan
- 8.43A *[Revoked]*
- 8.44 *[Revoked]*
- 8.44A *[Revoked]*
- 8.44B *[Revoked]*
- 8.45 Contracts with ancillary service agents
- 8.45A Methodology to assess net purchase quantity
- 8.46 *[Revoked]*
- 8.47 Departure from procurement plan

Alternative ancillary service arrangements

- 8.48 Alternative ancillary service arrangements
- 8.49 Suspension of alternative ancillary service arrangement
- 8.50 Modification of alternative ancillary service arrangement
- 8.51 Cancellation of alternative ancillary service arrangement
- 8.52 Revocation of alternative ancillary service arrangements
- 8.53 Appeal of system operator decisions
- 8.54 Other provisions relating to alternative ancillary service arrangements

Subpart 4—Interruptible load

- 8.54A Contents of this subpart

- 8.54AA System operator to maintain and publish register
- 8.54B Ancillary service agents to provide information about interruptible load

Subpart 5—*[Revoked]*

- 8.54C *[Revoked]*
- 8.54D *[Revoked]*
- 8.54E *[Revoked]*
- 8.54F *[Revoked]*
- 8.54G *[Revoked]*
- 8.54H *[Revoked]*
- 8.54I *[Revoked]*
- 8.54J *[Revoked]*
- 8.54K *[Revoked]*
- 8.54L *[Revoked]*
- 8.54M *[Revoked]*
- 8.54N *[Revoked]*
- 8.54O *[Revoked]*
- 8.54P *[Revoked]*
- 8.54Q *[Revoked]*
- 8.54R *[Revoked]*
- 8.54S *[Revoked]*
- 8.54T *[Revoked]*
- 8.54TA *[Revoked]*
- 8.54TB *[Revoked]*
- 8.54TC *[Revoked]*
- 8.54TD *[Revoked]*
- 8.54TE *[Revoked]*
- 8.54TF *[Revoked]*

Subpart 6—Allocating costs

- 8.54U Contents of this subpart

Allocating costs for ancillary services

- 8.55 Identifying costs associated with ancillary services
- 8.56 Black start costs allocated to grid owner
- 8.57 Over frequency reserve costs allocated to HVDC owner
- 8.58 Frequency keeping costs are allocated to purchasers
- 8.59 Availability costs allocated to generators and HVDC owner
- 8.60 System operator must investigate causer of under-frequency event
- 8.61 Authority to determine causer of under-frequency event
- 8.62 Disputes regarding Authority determinations
- 8.63 Decision of the Rulings Panel
- 8.64 Event costs allocated to event causers
- 8.65 Rebates paid for under-frequency events
- 8.66 Payments and rebates
- 8.67 Voltage support costs allocated in 3 parts – nominated peak, monthly peak and residual charges
- 8.67A *[Revoked]*
- 8.68 Clearing manager to determine amounts owing

- 8.69 Clearing manager to determine wash up amounts payable and receivable
8.70 System operator pays ancillary service agents

Schedule 8.1

Approval of equivalence arrangement or grant of dispensation

Schedule 8.2

Approval of alternative ancillary service arrangement

Schedule 8.3

Technical codes

Technical Code A – Assets

Appendix A: Main protection system requirements

Appendix B: Routine testing of assets and automatic under-frequency load shedding systems

Technical Code B – Emergencies

Technical Code C – Operational communications

Appendix A: Indications and Measurements

Technical Code D – Co-ordination of outages affecting common quality

Schedule 8.4

[Revoked]

Schedule 8.5

[Revoked]

Schedule 8.6

AUFLS technical requirements report incorporated by reference

8.1 Contents of this Part

This Part relates to **common quality**. In particular, this Part concerns the performance obligations of the **system operator**, the performance obligations of **asset owners**, arrangements concerning **ancillary services**, and **technical codes**.

Compare: Electricity Governance Rules 2003 rule 1 section I part C

Clause 8.1: amended, on 7 August 2014, by clause 5 of the Electricity Industry Participation Code Amendment (Extended Reserve) 2014.

Clause 8.1: amended, on 21 December 2021, by clause 6 of the Electricity Industry Participation Code Amendment (Automatic Under-Frequency Load Shedding Systems) 2021.

8.1A [Revoked]

Clause 8.1A: inserted, on 19 January 2017, by clause 4 of the Electricity Industry Participation Code Amendment (Extended Reserve) 2016.

Clause 8.1A: revoked, on 21 December 2021, by clause 7 of the Electricity Industry Participation Code Amendment (Automatic Under-Frequency Load Shedding Systems) 2021.

Subpart 1—Performance obligations of the system operator

8.2 Contents of this subpart

This subpart provides for—

- (a) general performance obligations of the **system operator**
- (b) a **policy statement** relating to the **principal performance obligations** of the **system operator**; and

- (c) the review of the **policy statement**.

Compare: Electricity Governance Rules 2003 rule 1 section II part C

8.3 Recovery of costs from causers of harmonic and voltage non-compliance

- (1) If the **system operator** is able to establish who is causing any departure from the standards referred to in clause 7.2(D), the **system operator** must endeavour to recover its reasonable identification and testing costs from that person. If the causer is a **participant**, the **participant** must pay those costs to the **system operator**.
- (2) If the **system operator** is unable to recover its reasonable identification and testing costs, or the causer is not able to be identified, then those costs will form part of the **system operator's identification costs**.

Compare: Electricity Governance Rules 2003 rule 2.3.2 section II part C

Clause 8.3 Heading: amended, on 19 May 2016, by clause 16(1) of the Electricity Industry Participation Code Amendment (System Operator and Alignment with Statutory Objective) 2016.

Clause 8.3(1): amended, on 19 May 2016, by clause 16(2) of the Electricity Industry Participation Code Amendment (System Operator and Alignment with Statutory Objective) 2016.

8.4 System operator may rely on information provided

For the purposes of this Code, the **system operator** may—

- (a) rely on the **assets** and information about the **assets** made available to the **system operator** by **asset owners**; and
- (b) assume that **asset owners** are complying with the **asset owner performance obligations** and the **technical codes**, or complying with a valid **dispensation** or **equivalence arrangement**
- (c) *[Revoked]*

Compare: Electricity Governance Rules 2003 rule 4 section II part C

Clause 8.4: replaced, on 19 January 2017, by clause 5 of the Electricity Industry Participation Code Amendment (Extended Reserve) 2016.

Clause 8.4(b): amended, on 21 December 2021, by clause 8(1) of the Electricity Industry Participation Code Amendment (Automatic Under-Frequency Load Shedding Systems) 2021.

Clause 8.4(c): revoked, on 21 December 2021, by clause 8(2) of the Electricity Industry Participation Code Amendment (Automatic Under-Frequency Load Shedding Systems) 2021.

8.5 Restoration

- (1) If an event disrupts the **system operator's** ability to comply with the **principal performance obligations**, the **system operator** must re-establish normal operation of the power system as soon as possible, given—
- (a) the capability of **generation**, and **ancillary services**; and
- (b) the configuration and capacity of the **grid**; and
- (c) the information made available by **asset owners**.
- (2) When re-establishing normal operation of the power system under subclause (1), the **system operator** must have regard to the following priorities:
- (a) first, the safety of natural persons:
- (b) second, the avoidance of damage to **assets**:
- (c) third, the restoration of **offtake**:
- (d) fourth, conformance with the **principal performance obligations**:
- (e) fifth, full conformance with the **dispatch objective**.

Compare: Electricity Governance Rules 2003 rule 5 section II part C

Clause 8.5(1): amended, on 19 May 2016, by clause 17 of the Electricity Industry Participation Code Amendment (System Operator and Alignment with Statutory Objective) 2016.

Clause 8.5(1)(a): amended, on 7 August 2014, by clause 6 of the Electricity Industry Participation Code Amendment (Extended Reserve) 2014.

Clause 8.5(1)(a): amended, on 21 December 2021, by clause 9 of the Electricity Industry Participation Code Amendment (Automatic Under-Frequency Load Shedding Systems) 2021.

8.6 System operator may contract for higher levels of common quality

Subject to clause 17.29, nothing in this Code prevents the **system operator** from entering into contracts or arrangements in which levels of quality more stringent than those specified in the **principal performance obligations** are agreed, if the **system operator** can identify the incremental costs of those more stringent levels, and can ensure that those incremental costs are paid to the **system operator** by the persons wishing to enter into that contract or arrangement with the **system operator**.

Compare: Electricity Governance Rules 2003 rule 6 section II part C

8.7 System operator must not contract contrary to this arrangement

Subject to clauses 8.6 and 17.29, the **system operator** must not enter into a contract with another person that is inconsistent with the **system operator's** obligations under this Code and the **technical codes**.

Compare: Electricity Governance Rules 2003 rule 7 section II part C

Policy statement

8.8 System operator to comply with policy statement

Subject to clause 8.14, the **system operator** must comply with the **policy statement**.

Compare: Electricity Governance Rules 2003 rule 8 section II part C

Clause 8.8: amended, on 19 May 2016, by clause 18 of the Electricity Industry Participation Code Amendment (System Operator and Alignment with Statutory Objective) 2016.

8.9 *[Revoked]*

Clause 8.9: revoked, on 10 January 2013, by clause 6 of the Electricity Industry Participation (Policy Statement and Procurement Plan Review Process) Code Amendment 2012.

8.10 Incorporation of policy statement by reference

(1) The **policy statement** is incorporated by reference in this Code.

(2) Clauses 7.13 to 7.22 apply to any amendment or replacement of the **policy statement**.

Compare: Electricity Governance Rules 2003 rule 9 section II part C

Clause 8.10(1): amended, on 10 January 2013, by clause 7 of the Electricity Industry Participation (Policy Statement and Procurement Plan Review Process) Code Amendment 2012.

Clause 8.10(1): amended, on 1 August 2023, by clause 10(1) of the Electricity Industry Participation Code Amendment (System Operation Documents) 2023.

Clause 8.10(2): amended, on 1 August 2023, by clause 10(2) of the Electricity Industry Participation Code Amendment (System Operation Documents) 2023.

Clause 8.10(2): amended, on 1 March 2024, by clause 26 of the Electricity Industry Participation Code Amendment (Code Review Programme) 2024.

8.10A *[Revoked]*

Clause 8.10A: inserted, on 10 January 2013, by clause 8 of the Electricity Industry Participation (Policy Statement and Procurement Plan Review Process) Code Amendment 2012.

Clause 8.10A(1): amended, on 5 October 2017, by clause 82 of the Electricity Industry Participation Code Amendment (Code Review Programme) 2017.

Clause 8.10A: revoked, on 1 August 2023, by clause 11 of the Electricity Industry Participation Code Amendment (System Operation Documents) 2023.

8.10B *[Revoked]*

Clause 8.10B: inserted, on 10 January 2013, by clause 8 of the Electricity Industry Participation (Policy Statement and Procurement Plan Review Process) Code Amendment 2012.

Clause 8.10B: revoked, on 1 August 2023, by clause 12 of the Electricity Industry Participation Code Amendment (System Operation Documents) 2023.

8.10C *[Revoked]*

Clause 8.10C: inserted, on 10 January 2013, by clause 8 of the Electricity Industry Participation (Policy Statement and Procurement Plan Review Process) Code Amendment 2012.

Clause 8.10C(3): amended, on 5 October 2017, by clause 83 of the Electricity Industry Participation Code Amendment (Code Review Programme) 2017.

Clause 8.10C: revoked, on 1 August 2023, by clause 13 of the Electricity Industry Participation Code Amendment (System Operation Documents) 2023.

8.11 Content of policy statement

(1) *[Revoked]*

(2) *[Revoked]*

(3) **A policy statement must include—**

- (a) the policies and means that the **system operator** considers appropriate for the **system operator** to observe in complying with its **principal performance obligations**; and
- (b) the policies and means by which scheduling and **dispatch** are adjusted to meet the **dispatch objective**, and must include the provision of a **dispatch** process statement. The **dispatch** process statement must contain the details of the processes that enable the **system operator** to meet the **dispatch objective**, including the methodologies to be used by the **system operator** for planning to meet the **dispatch objective** during the period leading up to real time and meeting the **dispatch objective** in real time; and
- (c) a policy setting out how the **system operator** will manage any conflict of interest that arises in the performance of its obligations under this Code; and
- (d) a statement of the reasons for adopting the policies and means set out in the **policy statement** (which statement must be regarded as an explanatory note only and does not form part of the policies itself); and
- (e) a statement of how future policies and means might be formulated and implemented.

Compare: Electricity Governance Rules 2003 rule 10 section II part C

Clause 8.11 Heading: substituted, on 10 January 2013, by clause 9(a) of the Electricity Industry Participation (Policy Statement and Procurement Plan Review Process) Code Amendment 2012.

Clause 8.11 Heading: amended, on 1 August 2023, by clause 14(1) of the Electricity Industry Participation Code Amendment (System Operation Documents) 2023.

Clause 8.11(1): revoked, on 10 January 2013, by clause 9(b) of the Electricity Industry Participation (Policy Statement and Procurement Plan Review Process) Code Amendment 2012.

Clause 8.11(2): revoked, on 10 January 2013, by clause 9(c) of the Electricity Industry Participation (Policy Statement and Procurement Plan Review Process) Code Amendment 2012.

Clause 8.11(3): amended, on 10 January 2013, by clause 9(d) of the Electricity Industry Participation (Policy Statement and Procurement Plan Review Process) Code Amendment 2012.

Clause 8.11(3): amended, on 19 May 2016, by clause 19(1) of the Electricity Industry Participation Code Amendment (System Operator and Alignment with Statutory Objective) 2016.

Clause 8.11(3)(c): amended, on 19 May 2016, by clause 19(2) of the Electricity Industry Participation Code Amendment (System Operator and Alignment with Statutory Objective) 2016.

Clause 8.11(3): amended, on 1 August 2023, by clause 14(2) of the Electricity Industry Participation Code Amendment (System Operation Documents) 2023.

8.11A *[Revoked]*

Clause 8.11A: inserted, on 10 January 2013, by clause 10 of the Electricity Industry Participation (Policy Statement and Procurement Plan Review Process) Code Amendment 2012.

Clause 8.11A(3)(b): amended, on 5 October 2017, by clause 84 of the Electricity Industry Participation Code Amendment (Code Review Programme) 2017.

Clause 8.11A: revoked, on 1 August 2023, by clause 15 of the Electricity Industry Participation Code Amendment (System Operation Documents) 2023.

8.12 *[Revoked]*

Compare: Electricity Governance Rules 2003 rule 11 section II part C

Clause 8.12: substituted, on 10 January 2013, by clause 11 of the Electricity Industry Participation (Policy Statement and Procurement Plan Review Process) Code Amendment 2012.

Clause 8.12(1), (2), (4) and (6): amended, on 5 October 2017, by clause 85(1) and (2) of the Electricity Industry Participation Code Amendment (Code Review Programme) 2017.

Clause 8.12: revoked, on 1 August 2023, by clause 16 of the Electricity Industry Participation Code Amendment (System Operation Documents) 2023.

8.12A *[Revoked]*

Clause 8.12A: inserted, on 10 January 2013, by clause 12 of the Electricity Industry Participation (Policy Statement and Procurement Plan Review Process) Code Amendment 2012.

Clause 8.12A(4)(a) and (6): amended, on 5 October 2017, by clause 86 of the Electricity Industry Participation Code Amendment (Code Review Programme) 2017.

Clause 8.12A: revoked, on 1 August 2023, by clause 17 of the Electricity Industry Participation Code Amendment (System Operation Documents) 2023.

8.12B *[Revoked]*

Clause 8.12B: inserted, on 10 January 2013, by clause 12 of the Electricity Industry Participation (Policy Statement and Procurement Plan Review Process) Code Amendment 2012.

Clause 8.12B(b): amended, on 5 October 2017, by clause 87 of the Electricity Industry Participation Code Amendment (Code Review Programme) 2017.

Clause 8.12B: revoked, on 1 August 2023, by clause 18 of the Electricity Industry Participation Code Amendment (System Operation Documents) 2023.

8.13 *[Revoked]*

Compare: Electricity Governance Rules 2003 rule 12 section II part C

Clause 8.13: revoked, on 10 January 2013, by clause 13 of the Electricity Industry Participation (Policy Statement and Procurement Plan Review Process) Code Amendment 2012.

8.14 Departure from policy statement

- (1) The **system operator** may depart from the policies set out in a **policy statement** when a **system security situation** arises and such departure is required for the **system operator** to comply with clause 7.1A(1).
- (2) If the **system operator** departs from a **policy statement** under subclause (1), the **system operator** must provide a report to the **Authority** setting out the circumstances of the **system security situation** and the actions taken to deal with it.
- (3) The **Authority** must **publish** the report within a reasonable time after receiving it.

Compare: Electricity Governance Rules 2003 rule 13 section II part C

Clause 8.14(1): amended, on 19 May 2016, by clause 20(1) of the Electricity Industry Participation Code Amendment (System Operator and Alignment with Statutory Objective) 2016.

Clause 8.14(2): amended, on 19 May 2016, by clause 20(2) of the Electricity Industry Participation Code Amendment (System Operator and Alignment with Statutory Objective) 2016.

Clause 8.14(3): substituted, on 10 January 2013, by clause 14 of the Electricity Industry Participation (Policy Statement and Procurement Plan Review Process) Code Amendment 2012.

Clause 8.14(3): amended, on 5 October 2017, by clause 88 of the Electricity Industry Participation Code Amendment (Code Review Programme) 2017.

System security forecast

8.15 System operator to prepare and review system security forecast

- (1) Every 2 years, the **system operator** must prepare, **publish**, and provide to the **Authority** a **system security forecast**.
- (1A) The **system security forecast** must—
 - (a) identify risks to the **system operator's** ability to meet the **principal performance obligations** over the ensuing period of not less than 36 months, and indicate how those risks can be managed; and
 - (b) take into account the capabilities of the **grid** and connected **assets** based on information known to, and able to be disclosed by, the **system operator**.
- (2) The date by which the **system operator** must **publish** the **system security forecast** and provide it to the **Authority** in each year in which the **system operator** is required to do so, is the date established for that purpose under rule 15 of section II of part C of the **rules**.
- (3) The **system operator** must review the most recent **system security forecast** prepared in accordance with subclause (1) at 6 monthly intervals until a new forecast or update is prepared. If, in the reasonable opinion of the **system operator**, a change has been made to the power system that would materially affect the most recent forecast or update, the **system operator** must amend the **system security forecast**, **publish** it and provide it to the **Authority**.

Compare: Electricity Governance Rules 2003 rule 15 section II part C

Clause 8.15(1): substituted, on 21 September 2012, by clause 8 of the Electricity Industry Participation (Minor Amendments) Code Amendment 2012.

Clause 8.15(1A): inserted, on 21 September 2012, by clause 8 of the Electricity Industry Participation (Minor Amendments) Code Amendment 2012.

Clause 8.15(1A)(b): amended, on 23 February 2015, by clause 75 of the Electricity Industry Participation Code Amendment (Distributed Generation) 2014.

Clause 8.15(1A)(b): amended, on 5 October 2017, by clause 89 of the Electricity Industry Participation Code Amendment (Code Review Programme) 2017.

Subpart 2—Asset owner performance obligations and technical standards

8.16 Contents of this subpart

This subpart provides for—

- (a) the establishment of performance obligations and technical standards for **asset owners** to assist the **system operator** in complying with the **principal performance obligations**; and
- (b) **asset owners** to obtain an assessment of their **assets** from the **system operator**; and
- (c) a process for the **system operator** to approve applications for **equivalence arrangements** and **dispensations** (if necessary).

Compare: Electricity Governance Rules 2003 rule 1 section III part C

Asset owner performance obligations and technical standards concerning frequency

8.17 Contribution by injections to overall frequency management

Each **generator** (while **synchronised**) and the **HVDC owner** must at all times ensure that its **assets**, other than any **generating units** within an **excluded generating station**, make the maximum possible **injection** contribution to maintain frequency within the **normal band** (and to restore frequency to the **normal band**). Any such contribution must be assessed against the **technical codes**.

Compare: Electricity Governance Rules 2003 rule 2.1 section III part C

8.18 Contributions by purchasers to overall frequency management

Each **purchaser** must limit the magnitude of any instantaneous change in the **offtake** of **electricity** and net rate of change in **offtake** to the levels the **system operator** reasonably requires. In setting those requirements, the **system operator** must have regard to the impact of the **offtake** on the **system operator's** ability to comply with the **principal performance obligations** concerning frequency (as set out in clause 7.2A to 7.2C) and the **dispatch objective**.

Compare: Electricity Governance Rules 2003 rule 2.2 section III part C

Clause 8.18: amended, on 19 May 2016, by clause 21 of the Electricity Industry Participation Code Amendment (System Operator and Alignment with Statutory Objective) 2016.

8.19 Contributions to frequency support in under-frequency events

- (1) Subject to subclause (3), each **generator** must at all times ensure that, while **electrically connected**, its **assets**, other than any **excluded generating stations**, contribute to supporting frequency by remaining **synchronised**, ensuring that each of its **generating units** can and does, at a minimum, sustain pre-event output—
 - (a) at all times when the frequency is above 47.5 Hertz; and
 - (b) for at least 120 seconds when the frequency is 47.5 Hertz; and
 - (c) for at least 20 seconds when the frequency is 47.3 Hertz; and
 - (d) for at least 5 seconds when the frequency is 47.1 Hertz; and
 - (e) for at least 0.1 seconds when the frequency is 47.0 Hertz; and
 - (f) at any frequencies between those specified in paragraphs (b) to (e) for times derived by linear interpolation.
- (2) If the **inherent characteristics** and design of a **generator's generating unit** are such that it is reasonably able to operate beyond the above requirements, the **generator** must declare such capabilities in accordance with clause 2(5) of **Technical Code A** of Schedule 8.3.
- (3) Each South Island **generator** must ensure that each of its **assets**, other than **excluded generating units**, remains **synchronised**, and can and do, at a minimum, sustain pre-event output—
 - (a) at all times when the frequency is above 47 Hertz; and
 - (b) for 30 seconds if the frequency falls below 47 Hertz but not below 45 Hertz.
- (4) The **HVDC owner** must at all times ensure that, while **electrically connected**, its **assets** contribute to supporting frequency during an **under-frequency event** in either **island**

by—

- (a) remaining **electrically connected** to those **assets** making up the **grid** in the North Island and South Island while the frequency in both **islands** remains above 48 Hertz; and
 - (b) remaining **electrically connected** to those **assets** making up the **grid** in the North Island and South Island while the frequency in both **islands** remains below 48 Hertz and above 47 Hertz for 90 seconds; and
 - (c) remaining **electrically connected** to those **assets** making up the **grid** in the North Island and South Island while the frequency in both **islands** remains above 45 Hertz for 35 seconds, unless the frequency in either **island** is less than 46.5 Hertz and the frequency is falling at a rate of 7 Hertz per second or greater; and
 - (d) subject to the level of transfer and the **HVDC link configuration** at the beginning of the **under-frequency event**, if the **HVDC link** itself is not the cause of the **under-frequency event**, modifying the instantaneous transfer on the **HVDC link** by up to 250 MW with the objective of limiting the difference between the North Island and South Island frequencies to no greater than 0.2 Hertz.
- (5) Each North Island **connected asset owner** and each South Island **grid owner** must ensure that it has established and maintained **automatic under-frequency load shedding** in block sizes and with relay settings in accordance with the **technical codes**.

Compare: Electricity Governance Rules 2003 rule 2.3 section III part C

Clause 8.19(5): substituted, on 7 August 2014, by clause 7 of the Electricity Industry Participation Code Amendment (Extended Reserve) 2014.

Clause 8.19(1) and (4): amended, on 23 February 2015, by clause 75 of the Electricity Industry Participation Code Amendment (Distributed Generation) 2014.

Clause 8.19(1) and (4): amended, on 5 October 2017, by clause 90 of the Electricity Industry Participation Code Amendment (Code Review Programme) 2017.

Clause 8.19(5): amended, on 21 December 2021, by clause 10 of the Electricity Industry Participation Code Amendment (Automatic Under-Frequency Load Shedding Systems) 2021.

Clause 8.19(4)(d): amended, on 1 March 2024, by clause 27 of the Electricity Industry Participation Code Amendment (Code Review Programme) 2024.

8.20 Contributions by grid owners to frequency support

Each **grid owner** must ensure that its **assets** are capable of being operated, and operate, within the frequency targets set out in clause 7.2A.

Compare: Electricity Governance Rules 2003 rule 2.4 section III part C

Clause 8.20: amended, on 19 May 2016, by clause 22 of the Electricity Industry Participation Code Amendment (System Operator and Alignment with Statutory Objective) 2016.

8.21 Excluded generating stations

- (1) For the purposes of clauses 8.17, 8.19, 8.25D, and the provisions in **Technical Code A** of Schedule 8.3 relating to the obligations of **asset owners** in respect of frequency, an **excluded generating station** means a **generating station** that exports less than 30 MW to a **local network** or the **grid**, unless the **Authority** has issued a direction under clause 8.38 that the **generating station** must comply with clauses 8.17, 8.19, 8.25A, and 8.25B and the relevant provisions in **Technical Code A** of Schedule 8.3.
- (2) Whether likely to be an **excluded generation station** or not, a **generator** who is planning to connect to the **grid** or a **local network** a **generating unit** with rated net maximum capacity equal to or greater than 1 MW must provide the **system operator** with written advice of its intention to connect together with other information relating to

that **generating unit** in accordance with clause 8.25(4).

Compare: Electricity Governance Rules 2003 rules 2.5 and 2.6 section III part C

Clause 8.21(1): amended, on 24 November 2016, by clause 5(1) and (2) of the Electricity Industry Participation Code Amendment (Generation Fault Ride Through) 2016.

Clause 8.21(2): amended, on 23 February 2015, by clause 75 of the Electricity Industry Participation Code Amendment (Distributed Generation) 2014.

Clause 8.21(2): amended, on 5 October 2017, by clause 91 of the Electricity Industry Participation Code Amendment (Code Review Programme) 2017.

Asset owner performance obligations and technical standards concerning voltage

8.22 Voltage range AOPOs

- (1) Each **grid owner** must ensure that its **assets** at and in between—
- (a) the **high voltage terminals** of the **grid owner's** transformers at each **grid injection point** and **grid exit point**; or
 - (b) if no transformer exists, the relevant **grid injection point** or **grid exit point**—
- are capable of being operated within the following range of voltages:

Nominal grid voltage (kV)	Voltage limits			
	Minimum (kV)		Maximum (kV)	
220	198	-10.0%	242	10.0%
110	99	-10.0%	121	10.0%
66	62.7	-5.0%	69.3	5.0%
50	47.5	-5.0%	52.5	5.0%

- (2) Each **generator** with a **point of connection** to the **grid** must at all times ensure that its **assets** are capable of being operated, and do operate, when the **grid** is operated within the range of voltages set out in subclause (1).
- (3) Each **connected asset owner** must ensure that its **local network** is capable of being operated, and does operate, when the **grid** is operated over the range of voltages set out in subclause (1).

Compare: Electricity Governance Rules 2003 rule 3.1 section III part C

Clause 8.22(3): amended, on 1 February 2016, by clause 8 of the Electricity Industry Participation Code Amendment (Code Review Programme) 2015.

8.23 Voltage support AOPOs

Each **generator** with a **point of connection** to the **grid** must at all times ensure that its **assets**—

- (a) when the voltage at its **grid injection point** is within the applicable range of nominal voltage, are capable of exporting (over excited) when **synchronised** and made available for **dispatch** by the **system operator**, a minimum net **reactive power** which is 50% of the maximum continuous **MW** output power as measured at the following **generating unit** terminals:

Nominal grid voltage (kV)	Voltage range for which reactive power is required			
	Minimum (kV)		Maximum (kV)	
220	198	-10.0%	242	10.0%
110	99	-10.0%	121	10.0%
66	62.7	-5.0%	69.3	5.0%
50	47.5	-5.0%	52.5	5.0%
33	31.35	-5.0%	34.65	5.0%
22	21.45	-2.5%	22.55	2.5%
11	10.725	-2.5%	11.275	2.5%

- (b) when the voltage at its **grid injection point** is within the applicable range of nominal voltage, are capable of importing (under excited) when **synchronised** and made available for **dispatch** by the **system operator**, a minimum net **reactive power** which is 33% of the maximum continuous **MW** output power as measured at the **generating unit** terminals as set out below:

Nominal grid voltage (kV)	Voltage range for which reactive power is required			
	Minimum (kV)		Maximum (kV)	
220	209	-5.0%	242	10.0%
110	104.5	-5.0%	121	10.0%
66	62.7	-5.0%	69.3	5.0%
50	47.5	-5.0%	52.5	5.0%
33	31.35	-5.0%	34.65	5.0%
22	21.45	-2.5%	22.55	2.5%
11	10.725	-2.5%	11.275	2.5%

- (c) when **synchronised**, continuously operate in a manner that supports voltage and voltage stability on the **grid** in compliance with the **technical codes**.

Compare: Electricity Governance Rules 2003 rule 3.2 section III part C
Clause 8.23: amended, on 21 September 2012, by clause 9 of the Electricity Industry Participation (Minor Amendments) Code Amendment 2012.

8.24 Load shedding obligations to support voltage

- (1) If it is not possible for a **connected asset owner** to comply with subclause (2), the **grid owner** must, if possible, establish load shedding in block sizes and at voltage levels (and, if automatic systems are established, with relay settings) set out in the **technical codes** or otherwise as the **system operator** reasonably requires.
- (2) In order to prevent the collapse of the **network** voltage, each **connected asset owner** must ensure that, if possible, it has established load shedding in block sizes and at voltage levels (and, if automatic systems are established, with relay settings) in accordance with the **technical codes** or otherwise as the **system operator** reasonably requires.

Compare: Electricity Governance Rules 2003 rule 3.3 section III part C

Clause 8.24(1): amended, on 1 February 2016, by clause 9 of the Electricity Industry Participation Code Amendment (Code Review Programme) 2015.

Clause 8.24(2): amended, on 1 May 2016, by clause 4 of the Electricity Industry Participation Code Amendment (Minor Code Amendments) 2016.

8.25 Other asset owner performance obligations and technical standards

- (1) Each **grid owner** must ensure that the design and configuration of its **assets** (including its connections to other persons) and associated protection arrangements are consistent with the **technical codes** and, in the reasonable opinion of the **system operator**, with maintaining the **system operator's** ability to comply with the **principal performance obligations**. In reaching this opinion, the **system operator** must have regard to the potential impact of the design or configuration of those **assets** or associated protection arrangements on its compliance with the **principal performance obligations** and achievement of the **dispatch objective**.
- (2) Each **grid owner** and each **connected asset owner** must use reasonable endeavours to ensure that a **generator** who meets the following criteria provides the **system operator** with written advice of the existence of its **generating unit** and the **generator's** name and address:
 - (a) the **generator** is directly connected to the **grid owner's grid** or directly or indirectly connected to the **local network** (as the case may be):
 - (b) the **generator** has a **generating unit** with a rated net maximum capacity equal to or greater than 1 **MW**.
- (3) Each **asset owner** and each **purchaser** must provide communication facilities that comply with the **technical codes** or otherwise, as the **system operator** reasonably requires, which must assist the **system operator** in planning to comply, and complying, with its **principal performance obligations** and achieving the **dispatch objective**.
- (4) Each **asset owner** and each **purchaser** must provide information that complies with the **technical codes** or otherwise as the **system operator** reasonably requests, to assist the **system operator** in planning to comply, and complying, with its **principal performance obligations** and achieving the **dispatch objective**.
- (5) If the **system operator** reasonably considers it necessary to assist the **system operator** in planning to comply, and complying, with the **principal performance obligations** and achieving the **dispatch objective**, the **system operator**—
 - (a) may require that an **embedded generator** provide information regarding the intended output of each **embedded generating station** greater than 10 **MW** in capacity, that must be either—
 - (i) submitted as an **offer** in accordance with subpart 1 of Part 13; or
 - (ii) provided in a form and manner agreed between the **system operator** and the **embedded generator**; and
 - (b) must advise the **embedded generator** of its requirement at least 20 **business days** in advance of the requirement coming into effect.
- (6) If the **system operator** reasonably considers it necessary to assist it in planning to comply, and complying, with the **principal performance obligations** and achieving the **dispatch objective**, the **system operator** may apply to the **Authority** to require an **embedded generator** to provide information regarding the intended output of a group of **embedded generating stations** that total greater than 10 **MW** in capacity and that

are connected to the same **grid exit point**. If the **Authority** approves the **system operator's** request, the information must be provided to the **system operator** by the relevant **embedded generator** in a form and manner determined by the **Authority**.

Compare: Electricity Governance Rules 2003 rule 4.1 to 4.6 section III part C

Clause 8.25(1), (2) and (6): amended, on 23 February 2015, by clause 75 of the Electricity Industry Participation Code Amendment (Distributed Generation) 2014.

Clause 8.25(1), (2) and (6): amended, on 5 October 2017, by clause 92(1) and (2) of the Electricity Industry Participation Code Amendment (Code Review Programme) 2017.

Clause 8.25(2): amended, on 1 February 2016, by clause 10 of the Electricity Industry Participation Code Amendment (Code Review Programme) 2015.

Clause 8.25(2): amended, on 20 December 2021, by clause 10 of the Electricity Industry Participation Code Amendment (Code Review Programme) 2019.

Clause 8.25(5)(b): amended, on 5 October 2017, by clause 92(3) of the Electricity Industry Participation Code Amendment (Code Review Programme) 2017.

Clause 8.25(5)(b): amended, on 1 November 2018, by clause 11 of the Electricity Industry Participation Code Amendment (Code Review Programme) 2018.

8.25A Fault ride through

- (1) Each **generator** must ensure that each of its **assets**, when **electrically connected** to a **network**, is capable of remaining stable and **electrically connected** when the **grid's** lowest **line-to-line** voltage is within the no-trip zone shaded and marked "No-trip zone" in Figure 8.1 (for an **asset** in the North Island) or Figure 8.2 (for an **asset** in the South Island) for the period of 6 seconds immediately following the commencement of a zero impedance three-phase short circuit fault, or an unbalanced short circuit fault, on any part of the **grid** at 110 kV or 220 kV in the **island** in which the **asset** is connected.
- (2) Each **generator** must ensure that each of its **assets**, when **electrically connected** to a **network**, is capable of remaining stable and **electrically connected** when the highest **line-to-line** voltage at Haywards 220 kV bus (for an **asset** in the North Island) or Benmore 220 kV bus (for an **asset** in the South Island) is within the no-trip zone shaded and marked "No-trip zone" in Figure 8.3 for the period of 1 second immediately following the commencement of a trip of the **HVDC link**.
- (3) Whether a **generator** is complying with subclause (2) must be determined using power system analysis that uses—
 - (a) study cases provided by the relevant **grid owner**; and
 - (b) relevant system assumptions provided by the **system operator**.
- (4) A **generator** is not required to comply with subclause (1) in respect of an **asset** in the event of a fault of a type described in subclause (1) if the **asset** becomes isolated from the **grid** as a result of the fault.
- (5) A **generating unit** need not comply with subclause (1) to the extent that it is complying with a **special protection scheme** approved by the **system operator**.
- (6) The absolute **grid** voltage (per unit) shown on the Y axis of Figure 8.1 and Figure 8.2 is the ratio of **grid** lowest **line-to-line** voltage on a **line** to the nominal operating voltage of the **line** (that is, 110 kV or 220 kV).

Figure 8.1: North Island no-trip zone during 110 kV or 220 kV faults

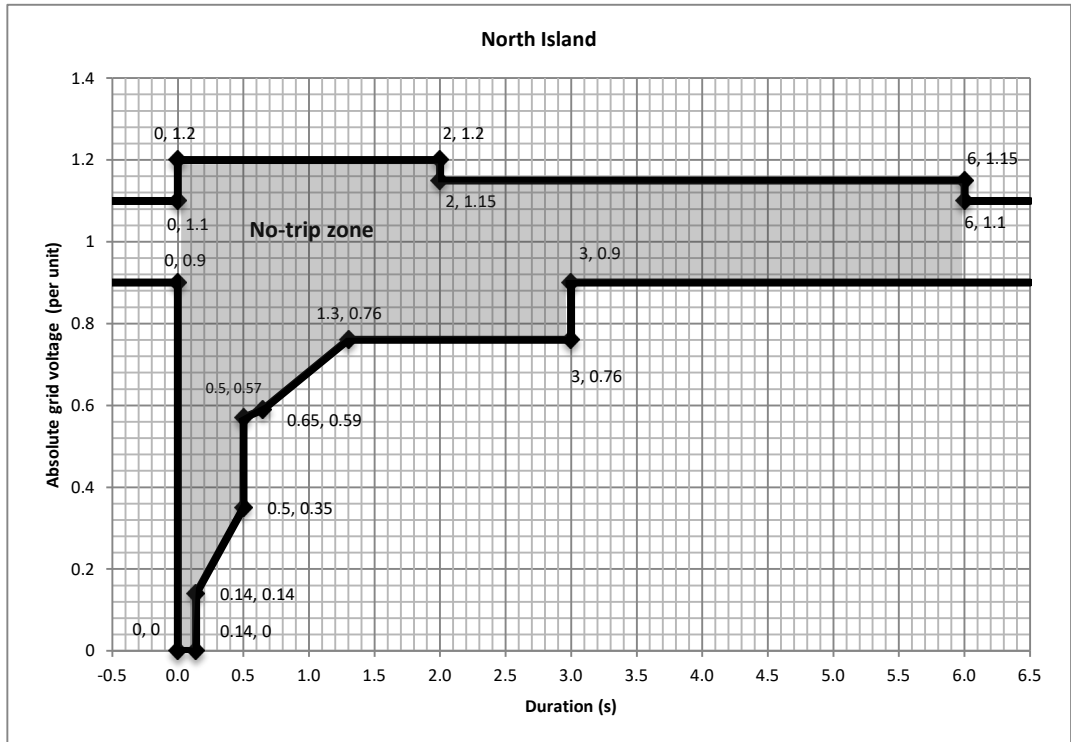

Figure 8.2: South Island no-trip zone during 110 kV or 220 kV faults

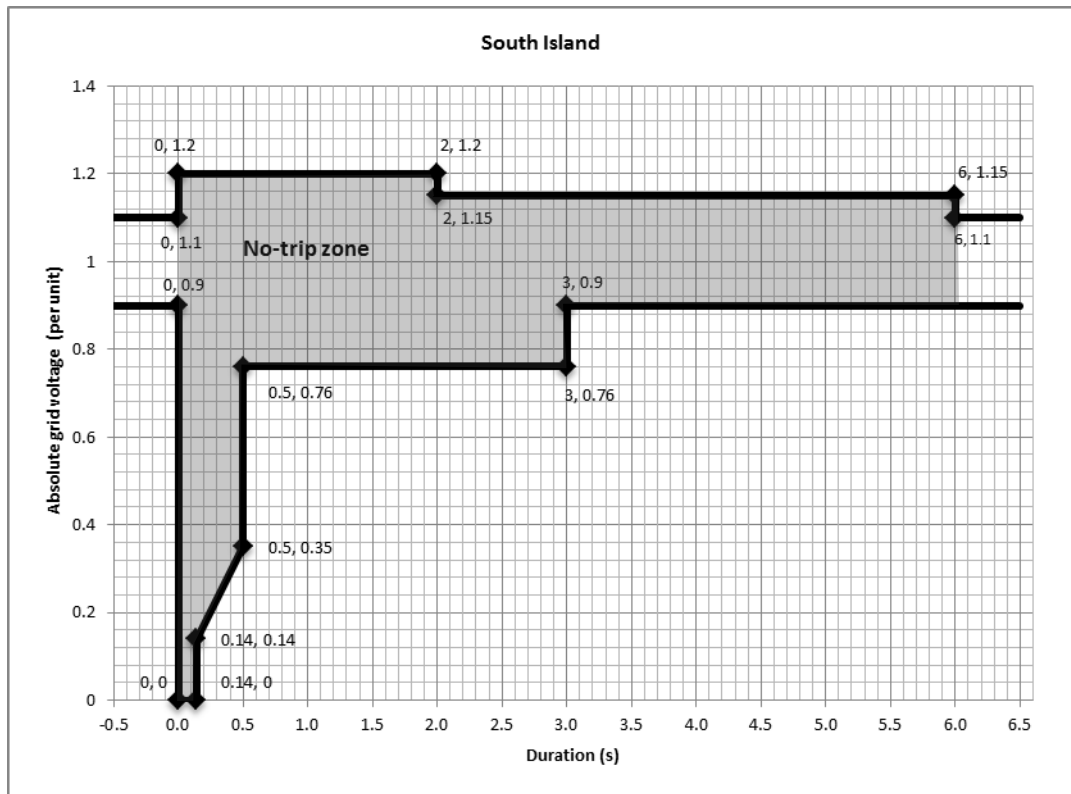
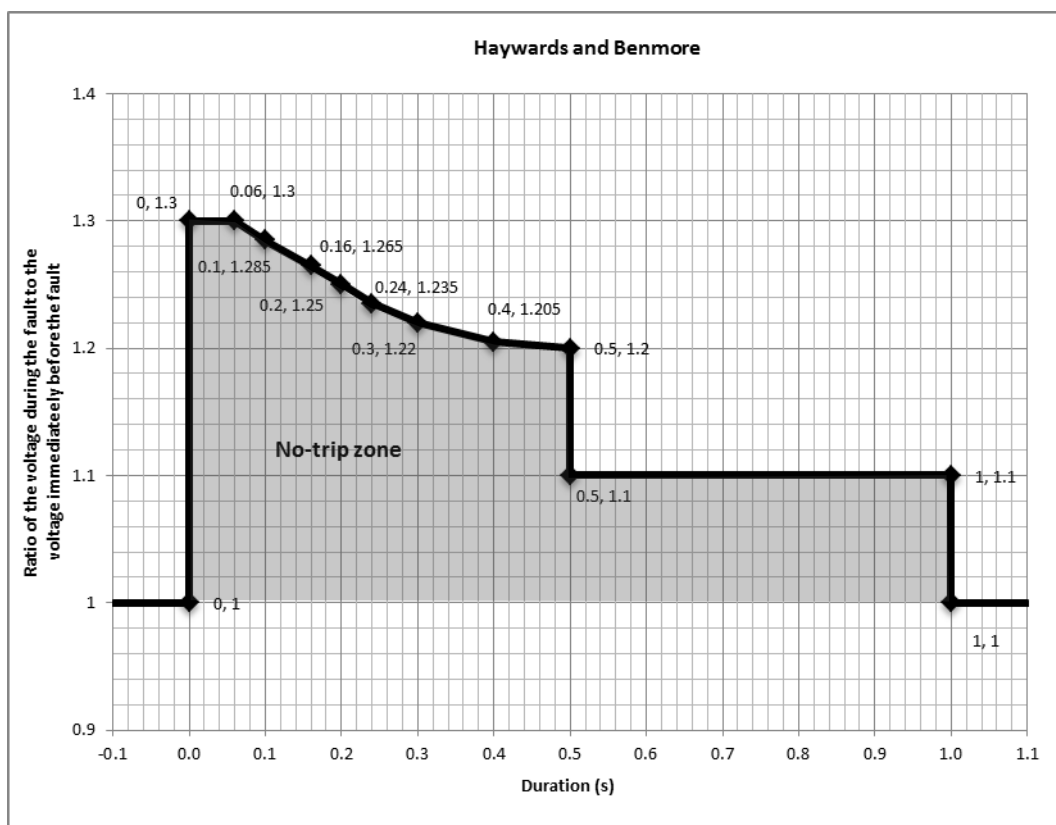

Figure 8.3: Haywards and Benmore no-trip zone during permanent loss of the HVDC link



Clause 8.25A Figure 8.1, Figure 8.2 and Figure 8.3: inserted, on 24 November 2016, by clause 6 of the Electricity Industry Participation Code Amendment (Generation Fault Ride Through) 2016.

Clause 8.25A(1): amended, on 5 October 2017, by clause 93(1) of the Electricity Industry Participation Code Amendment (Code Review Programme) 2017.

Clause 8.25A(2): amended, on 5 October 2017, by clause 93(2) of the Electricity Industry Participation Code Amendment (Code Review Programme) 2017.

8.25B Reactive current and active power output

- (1) Each **generator** must ensure that each of its **generating units** generates **reactive current** to oppose the change in its terminal voltage without exceeding the maximum transient **reactive current** specified in the **generator's asset capability statement** for the period of 6 seconds immediately following the commencement of a fault on the **grid** of a type described in clause 8.25A(1).
- (2) Each **generator** must ensure that each of its **generating units** provides **active power** output relative to pre-fault **active power** output at least in proportion to the **grid** voltage at the **grid injection point** for the period of 6 seconds immediately following the clearance of a fault on the **grid** of a type described in clause 8.25A(1).
- (3) Subclause (2) does not apply to a **wind generating station** if there has been a reduction in the intermittent wind power source during the 6 seconds following the commencement of the fault.

Clause 8.25B: inserted, on 24 November 2016, by clause 6 of the Electricity Industry Participation Code Amendment (Generation Fault Ride Through) 2016.

8.25C Use of additional equipment

A **generator** may comply with clause 8.25A in relation to a **generating station** by—

- (a) ensuring that the performance of **generating units** that comprise the **generating station** comply; or

- (b) installing additional equipment within the **generating station**; or
- (c) a combination of the methods described in paragraphs (a) and (b).

Clause 8.25C: inserted, on 24 November 2016, by clause 6 of the Electricity Industry Participation Code Amendment (Generation Fault Ride Through) 2016.

8.25D Application

Clauses 8.25A and 8.25B do not apply—

- (a) to a **wind generating station** when it operates at less than 5% of rated **MW**; or
- (b) to any **asset** at an **excluded generating station**.

Clause 8.25D: inserted, on 24 November 2016, by clause 6 of the Electricity Industry Participation Code Amendment (Generation Fault Ride Through) 2016.

8.26 Asset owners must co-operate

Each **asset owner** and each **purchaser** must co-operate with the **system operator** as may reasonably be required by the **system operator** in carrying out its functions.

Compare: Electricity Governance Rules 2003 rule 4.7 section III part C

Compliance

8.27 System operator to monitor compliance

- (1) To the extent possible, given the information made available by **asset owners**, the **system operator** must monitor, in the manner set out in the **policy statement**, the ongoing compliance of **asset owners** with the **asset owner performance obligations** and the **technical codes**. To avoid doubt, the **system operator** has no monitoring obligations under this subpart other than those set out in the **policy statement**.
- (2) The **system operator** has a discretion to not **dispatch** an **asset** or configuration of **assets**, if it is not satisfied that the **assets** or configuration of **assets** comply with the relevant **asset owner performance obligations** or provisions of the **technical codes**, or that the **asset owner** has and is complying with a valid **equivalence arrangement** or **dispensation** from the relevant **asset owner performance obligations** or provisions of the **technical codes**.
- (3) The **system operator** must immediately advise an **asset owner** if the **system operator** has reasonable grounds to believe that the **asset owner** is not complying with an **asset owner performance obligation**, **equivalence arrangement** or **dispensation**, and that the **asset owner**—
 - (a) does not have a valid **equivalence arrangement** or **dispensation** from the relevant **asset owner performance obligations** or provisions of the **technical codes**: or
 - (b) is not complying with a valid **equivalence arrangement** or **dispensation** from the relevant **asset owner performance obligations** or provisions of the **technical codes**.

Compare: Electricity Governance Rules 2003 rule 5 section III part C

Clause 8.27(2): amended, on 19 May 2016, by clause 23 of the Electricity Industry Participation Code Amendment (System Operator and Alignment with Statutory Objective) 2016.

8.28 Responsibility for compliance

- (1) Each **asset owner** must comply with the **asset owner performance obligations** and **technical codes** at all times and must satisfy the **system operator**, whenever requested by the **system operator** acting reasonably, that each of its **assets** or configuration of **assets** complies with the **asset owner performance obligations** and **technical codes** that apply to that **asset** or configuration of **assets**.
- (2) If the **system operator** advises an **asset owner** under clause 8.27(3), the **asset owner** must co-operate with the **system operator** and use reasonable endeavours to restore compliance as soon as practicable.
- (3) During a period of **commissioning** or testing of **assets**, the **asset owner performance obligations** and **technical codes** do not apply to the **asset owner** in respect of the **assets**, if—
 - (a) the obligations that do not apply to the **asset owner** are specified in the agreed **commissioning** plan or testing plan; and
 - (b) during the period of non-compliance the **asset owner** complies with a **commissioning** plan or testing plan (as appropriate) agreed with the **system operator**; and
 - (c) the period of non-compliance is no longer than the agreed **commissioning** plan or testing plan; and
 - (d) subject to subclause (4), if an **asset owner** during a period of non-compliance meets the requirements of paragraphs (a) to (c), neither the **asset owner** nor the **system operator** is liable under this Code in relation to the non-compliance, except that the **asset owner** is not relieved of liability in the case of a negligent act or omission by the **asset owner**.
- (4) During any period of non-compliance, the non-compliant **asset owner** must pay the readily identifiable and quantifiable costs associated with its non-compliance, including the costs of the **system operator** purchasing additional **ancillary services** required as a consequence of its non-compliance.

Compare: Electricity Governance Rules 2003 rule 6 section III part C

Clause 8.28(2): amended, on 1 November 2018, by clause 12 of the Electricity Industry Participation Code Amendment (Code Review Programme) 2018

Clause 8.28(3): amended, on 5 October 2017, by clause 94 of the Electricity Industry Participation Code Amendment (Code Review Programme) 2017.

Equivalence arrangements and dispensations

8.29 Right to apply for approval of equivalence arrangement or grant of dispensation

- (1) Subject to subclause (2), if an **asset owner** cannot comply with an **AOPO** or a **technical code** obligation in respect of a particular **asset** or configuration of **assets**, being an existing, new or proposed **asset**, the **asset owner** may apply for an **equivalence arrangement** to be approved or **dispensation** to be granted in accordance with Schedule 8.1.
- (2) The **system operator** may not grant a dispensation in relation to an obligation to provide **automatic under-frequency load shedding** under clause 8.19(5) or Schedule 8.3, Technical Code B, clause 7.

Compare: Electricity Governance Rules 2003 rule 7.1 section III part C
Clause 8.29(1): amended, on 7 August 2014, by clause 8(1) of the Electricity Industry Participation Code Amendment (Extended Reserve) 2014.
Clause 8.29(2): inserted, on 7 August 2014, by clause 8(2) of the Electricity Industry Participation Code Amendment (Extended Reserve) 2014.
Clause 8.29(2): amended, on 21 December 2021, by clause 11 of the Electricity Industry Participation Code Amendment (Automatic Under-Frequency Load Shedding Systems) 2021.

8.30 Approval of equivalence arrangements

The **system operator** must approve an **equivalence arrangement** if it has received satisfactory evidence that the **asset owner** will put in place on the agreed date technical or commercial arrangements that will, in the reasonable opinion of the **system operator**, achieve compliance with the **AOPO** or **technical code** for which the **equivalence arrangement** is sought, even if the **assets** or configuration of **assets** do not strictly comply.

Compare: Electricity Governance Rules 2003 rule 7.2 section III part C

8.31 Grant of dispensations

- (1) Subject to subclause (1A), the **system operator** must grant a **dispensation** to an **asset owner** who has or will have **assets** or a configuration of **assets** that do not comply with either an **AOPO** or **technical code** if the **system operator** has a reasonable expectation that it can continue to operate the existing system and meet its **principal performance obligations** and if the **system operator** can readily quantify the costs on other persons of that **dispensation**, despite the non-compliance of the **assets**, but—
- (a) if the approval of a **dispensation** could impose readily identifiable and quantifiable costs on other persons, a condition of the **dispensation** must be that the **asset owner** is liable to pay the **system operator** for those costs, including the costs of the **system operator** purchasing any other **ancillary services** required as a consequence of its **dispensation**; and
 - (b) the **asset owner** must acknowledge that the granting of a **dispensation** does not guarantee that the **system operator** will **dispatch** that **asset** for which the **dispensation** was granted, as **dispatch** will only occur in accordance with the **dispatch objective**; and
 - (c) if the **dispensation** is a **generating unit dispensation** from clause 8.19(1) or (3), the **generator** must be allocated the following costs in a relevant **trading period** with respect to paragraph (a) for each of **fast instantaneous reserves** or **sustained instantaneous reserves**:

$$\text{DispCost}_{\text{GENxt}} = 0.5 * Q_{\text{GENxt}} * P_{\text{IRt}}$$

where

DispCost_{GENxt} is the cost payable by a **generator** for **generating unit x** in any **trading period t** in which a class of **instantaneous reserves** is procured as a direct result of that **generating unit's dispensation** to ensure that the frequency does not fall below 47 Hertz or, in the South Island, below the **minimum South Island frequency**

- Q_{GENxt}** is the **MW** amount by which **generating unit x** is unable to sustain pre-event output in **trading period t** with reference to clause 8.19(1) or (3) (as the case may be) as determined from the capabilities specified in that **generating unit's dispensation** (different amounts may be specified with respect to each class of **instantaneous reserves**)
- P_{IRt}** is the **final reserve price** for **fast instantaneous reserves** or **sustained instantaneous reserves** (as the case may be) in **trading period t** in the relevant **island**.

- (1A) If the **system operator** grants a **dispensation** from clause 8.25A or clause 8.25B to an **asset owner** under subclause (1), and the granting of the **dispensation** could impose readily identifiable and quantifiable costs on any other person, the **system operator** must not impose a condition on the **asset owner** in accordance with subclause (1)(a) that has effect earlier than 24 November 2018.
- (2) The **system operator** may impose other reasonable conditions on the grant of a **dispensation** under subclause (1), including conditions as to duration of the **dispensation**.

Compare: Electricity Governance Rules 2003 rules 7.3 and 7.4 section III part C

Clause 8.31(1): amended, on 15 May 2014, by clause 7 of the Electricity Industry Participation (Minor Code Amendments) Code Amendment 2014.

Clause 8.31(1): amended, on 24 November 2016, by clause 7(1) of the Electricity Industry Participation Code Amendment (Generation Fault Ride Through) 2016.

Clause 8.31(1)(c): amended, on 19 May 2016, by clause 24 of the Electricity Industry Participation Code Amendment (System Operator and Alignment with Statutory Objective) 2016.

Clause 8.31(1A): inserted, on 24 November 2016, by clause 7(2) of the Electricity Industry Participation Code Amendment (Generation Fault Ride Through) 2016.

8.32 Liability of asset owner pending decision

Pending determination of an **asset owner's** application for a **dispensation** or an **equivalence arrangement**, if the **asset** does not comply with the **AOPOs** or the **technical codes**, the **asset owner** is liable for the non-compliance and is responsible for additional costs incurred by the **system operator** or **asset owners** as a result of the non-compliance, including the costs of the **system operator** purchasing other **ancillary services** as a consequence of the non-compliance.

Compare: Electricity Governance Rules 2003 rule 8 section III part C

Clause 8.32: amended, on 15 May 2014, by clause 8 of the Electricity Industry Participation (Minor Code Amendments) Code Amendment 2014.

8.33 Modification of equivalence arrangement or dispensation

An **asset owner** may apply to the **system operator** for a modification to an **equivalence arrangement** or **dispensation**, in which case clauses 8.34 to 8.36 and Schedule 8.1 apply.

Compare: Electricity Governance Rules 2003 rule 8.1 section III part C

8.34 Cancellation of equivalence arrangement or dispensation

- (1) An **asset owner** may at any time give written notice to the **system operator** for an

equivalence arrangement or a **dispensation** to be cancelled on the grounds that the **asset** or configuration of **assets** subject to the **equivalence arrangement** or **dispensation** complies with **AOPOs** or **technical codes**.

- (2) A cancellation takes effect on the date specified in the notice as being the date the **system operator** accepted the cancellation.
- (3) The **system operator** must record the cancellation in the **system operator register** no later than 5 days after receiving the notice.

Compare: Electricity Governance Rules 2003 rule 8.2 section III part C

8.35 Revocation of equivalence arrangement and revocation or variation of dispensation

- (1) The **system operator** may revoke approval of an **equivalence arrangement** or revoke or vary the grant of a **dispensation** as the **system operator** reasonably considers appropriate if, at any time after the **system operator** has approved an **equivalence arrangement** or granted a **dispensation**, the **system operator** is satisfied that 1 or more of the following apply:
 - (a) the **dispensation** or **equivalence arrangement** was approved on information that was false or materially misleading;
 - (b) a prerequisite of the **dispensation** or **equivalence arrangement** has changed;
 - (c) a condition on which the **dispensation** or **equivalence arrangement** was approved has not been complied with;
 - (d) withdrawal is **provided** for under the terms of the **dispensation** granted;
 - (e) a change to this Code has occurred that affects the **dispensation** or **equivalence arrangement**;
 - (f) a decision has been reconsidered at the direction of the **Rulings Panel** under clause 8.36(4).
- (2) The **system operator** must not revoke or amend a **dispensation** or grant a further **dispensation** or revoke its approval of an **equivalence arrangement** under subclause (1), unless—
 - (a) the **asset owner** to whom the **dispensation** was granted, or for whom an **equivalence arrangement** was approved, and any other person who in the opinion of the **system operator** is likely to have an interest in the matter, is given reasonable notice of the **system operator**'s intentions and a reasonable opportunity to make submissions to the **system operator** on the issue; and
 - (b) the **system operator** has had regard to the submissions.

Compare: Electricity Governance Rules 2003 rule 8.3 section III part C

8.36 Appeal against decisions

- (1) A **participant** may appeal a decision of the **system operator** in relation to an application for **dispensation** or **equivalence arrangements** on the grounds set out in subclause (3).
- (2) An appeal must be made to the **Rulings Panel** by giving written notice to the **Authority** specifying the grounds of appeal. A notice must be given no later than 10 **business days** after publication of the relevant decision in the **system operator register** under clause 8 of Schedule 8.1.

- (3) For the purposes of subclause (2), an appeal may be made on the grounds that—
 - (a) the **system operator** made an error of fact or failed to take into account all relevant information or took into account irrelevant information and such error, failure or irrelevancy was material to the decision; or
 - (b) the conditions imposed on the **dispensation** or **equivalence arrangement** are unjustifiably onerous, unnecessary or impose extra costs if appropriate alternatives exist.
- (4) The **Rulings Panel**, in determining an appeal, must approve the decision of the **system operator** or direct the **system operator** to reconsider the decision in full or by reference to specified matters.
- (5) Pending the outcome of an appeal, the decision of the **system operator** in relation to the grant of a **dispensation** or approval of an **equivalence arrangement** remains valid and may be relied upon by the relevant **asset owner**.

Compare: Electricity Governance Rules 2003 rule 8.4 section III part C
Clause 8.36(1): amended, on 1 November 2018, by clause 13 of the Electricity Industry Participation Code Amendment (Code Review Programme) 2018.

8.37 Other provisions relating to equivalence arrangements and dispensations

- (1) An **asset owner** who obtains approval for an **equivalence arrangement** must comply with its obligations under that arrangement.
- (1A) An **asset owner** who is granted a **dispensation** must comply with its obligations under that **dispensation**.
- (2) An **equivalence arrangement** and a **dispensation** are specific to an **asset owner**, and no approval of an **equivalence arrangement** or granting of a **dispensation** creates a precedent for the approval of other **equivalence arrangements** or **dispensations**.
- (3) The owner or operator of an **asset** or configuration of **assets** must advise the **system operator** if the owner or operator believes that it is in breach of a condition of its **dispensation** or **equivalence arrangement** or that the **asset** or configuration of **assets**, including any **equivalence arrangement**, does not, or is likely not to, comply with the **asset owner performance obligations** and **technical codes**.
- (4) If an **asset owner** fails to put in place, maintain and meet all requirements of an approved **equivalence arrangement** or **dispensation**, the **asset owner** is in breach of this Code.

Compare: Electricity Governance Rules 2003 rule 9 section III part C
Clause 8.37(1A): inserted, on 15 May 2014, by clause 9 of the Electricity Industry Participation (Minor Code Amendments) Code Amendment 2014.

8.38 Authority may require excluded generating stations to comply with certain clauses

- (1) Despite clauses 8.17, 8.19, and 8.25D, the **system operator** may, at any time, apply to the **Authority** for the **Authority** to issue a directive that an **excluded generating station asset** must comply with clauses 8.17, 8.19, 8.25A, and 8.25B, and the provisions of the **technical codes** (or parts thereof).
- (2) The **Authority** must issue the directive referred to in subclause (1) if the **Authority** is satisfied that there is a **benefit to the public** in obtaining compliance.
- (3) If a directive is issued under subclause (2), the owner of the **excluded generating station asset** must comply with the directive with effect from the date specified in the

directive.

Compare: Electricity Governance Rules 2003 rule 10 section III part C

Clause 8.38(1): amended, on 24 November 2016, by clause 8(1) and (2) of the Electricity Industry Participation Code Amendment (Generation Fault Ride Through) 2016.

Subpart 3—Arrangements concerning ancillary services

8.39 Contents of this subpart

This subpart provides for—

- (a) a **procurement plan** that the **system operator** must use reasonable endeavours to implement and comply with; and
- (b) the review of the **procurement plan**; and
- (c) **alternative ancillary service arrangements**; and
- (d) how **ancillary services** are to be priced and measured; and
- (e) identifying the **allocable costs** for **ancillary services** and the regime by which those costs are allocated to affected parties.

Compare: Electricity Governance Rules 2003 rule 1 section IV part C

Procurement plan

8.40 System operator to use reasonable endeavours to implement and comply with procurement plan

The **system operator** must use reasonable endeavours to both implement and comply with the **procurement plan**.

Compare: Electricity Governance Rules 2003 rule 2 section IV part C

8.41 *[Revoked]*

Clause 8.41: revoked, on 10 January 2013, by clause 15 of the Electricity Industry Participation (Policy Statement and Procurement Plan Review Process) Code Amendment 2012.

8.42 Incorporation of procurement plan by reference

- (1) The **procurement plan** is incorporated by reference in this Code.
- (2) Clauses 7.13 to 7.22 apply to any amendment or replacement of the **procurement plan**.

Compare: Electricity Governance Rules 2003 rule 3 section IV part C

Clause 8.42(1): amended, on 10 January 2013, by clause 16 of the Electricity Industry Participation (Policy Statement and Procurement Plan Review Process) Code Amendment 2012.

Clause 8.42(1): amended, on 1 August 2023, by clause 19(1) of the Electricity Industry Participation Code Amendment (System Operation Documents) 2023.

Clause 8.42(2): amended, on 1 August 2023, by clause 19(2) of the Electricity Industry Participation Code Amendment (System Operation Documents) 2023.

Clause 8.42(2): amended, on 1 March 2024, by clause 28 of the Electricity Industry Participation Code Amendment (Code Review Programme) 2024.

8.42A *[Revoked]*

Clause 8.42A: inserted, on 10 January 2013, by clause 17 of the Electricity Industry Participation (Policy Statement and Procurement Plan Review Process) Code Amendment 2012.

Clause 8.42A(1): amended, on 5 October 2017, by clause 95 of the Electricity Industry Participation Code Amendment (Code Review Programme) 2017.

Clause 8.42A: revoked, on 1 August 2023, by clause 20 of the Electricity Industry Participation Code Amendment (System Operation Documents) 2023.

8.42B *[Revoked]*

Clause 8.42B: inserted, on 10 January 2013, by clause 17 of the Electricity Industry Participation (Policy Statement and Procurement Plan Review Process) Code Amendment 2012.

Clause 8.42B: revoked, on 1 August 2023, by clause 21 of the Electricity Industry Participation Code Amendment (System Operation Documents) 2023.

8.42C *[Revoked]*

Clause 8.42C: inserted, on 10 January 2013, by clause 17 of the Electricity Industry Participation (Policy Statement and Procurement Plan Review Process) Code Amendment 2012.

Clause 8.42C(3): amended, on 5 October 2017, by clause 96 of the Electricity Industry Participation Code Amendment (Code Review Programme) 2017.

Clause 8.42C: revoked, on 1 August 2023, by clause 22 of the Electricity Industry Participation Code Amendment (System Operation Documents) 2023.

8.43 Content of procurement plan

A **procurement plan** must, for each **ancillary service**—

- (a) specify the principles that the **system operator** must apply in making a **net purchase quantity assessment**, which must include—
 - (i) determining the requirements for complying with the **principal performance obligations**; and
 - (ii) determining the requirements for achieving the **dispatch objective**; and
 - (iii) assessing the contribution that compliance by **asset owners** with the **asset owner performance obligations** will make towards the **system operator's** compliance with the **principal performance obligations**; and
 - (iv) assessing the impact that **dispensations** and **alternative ancillary services arrangements** held by **asset owners** will have on the quantity of **ancillary services** required to enable the **system operator** to comply with the **principal performance obligations**; and
- (b) contain a methodology for conducting a **net purchase quantity assessment** for each relevant **ancillary service**; and
- (c) outline the process that the **system operator** must use to procure that **ancillary service**, taking into account that the **system operator** must use—
 - (i) market mechanisms to procure **ancillary services** wherever technology and transaction costs make this practicable and efficient; and
 - (ii) transparent processes that encourage all potential providers to compete to supply **ancillary services** required to meet **common quality** standards at the best economic cost; and
- (d) specify the **administrative costs** for that **ancillary service** as proposed in the **procurement plan**; and
- (e) outline the **system operator's** technical requirements and key contract terms to support the **procurement plan**; and
- (f) outline the rights and obligations of the **system operator** in relation to procurement of that **ancillary service** in circumstances not anticipated by the **procurement plan**, and if the assumptions made by the **system operator** in the **procurement plan** cannot be met; and
- (g) outline how the **system operator** will report on progress in implementing the **procurement plan**.

Compare: Electricity Governance Rules 2003 rule 4 section IV part C

Clause 8.43 Heading: amended, on 1 August 2023, by clause 23(1) of the Electricity Industry Participation Code Amendment (System Operation Documents) 2023.

Clause 8.43: substituted, on 10 January 2013, by clause 18 of the Electricity Industry Participation (Policy Statement and Procurement Plan Review Process) Code Amendment 2012.

Clause 8.43: amended, on 19 December 2014, by clause 9 of the Electricity Industry Participation Code Amendment (Minor Code Amendments) (No 3) 2014.

Clause 8.43: amended, on 1 August 2023, by clause 23(2) of the Electricity Industry Participation Code Amendment (System Operation Documents) 2023.

Clause 8.43(d): amended, on 1 August 2023, by clause 23(3) of the Electricity Industry Participation Code Amendment (System Operation Documents) 2023.

Clause 8.43(f): amended, on 1 August 2023, by clause 23(4) of the Electricity Industry Participation Code Amendment (System Operation Documents) 2023.

8.43A *[Revoked]*

Clause 8.43A: inserted, on 10 January 2013, by clause 19 of the Electricity Industry Participation (Policy Statement and Procurement Plan Review Process) Code Amendment 2012.

Clause 8.43A(3)(b): amended, on 5 October 2017, by clause 97 of the Electricity Industry Participation Code Amendment (Code Review Programme) 2017.

Clause 8.43A: revoked, on 1 August 2023, by clause 24 of the Electricity Industry Participation Code Amendment (System Operation Documents) 2023.

8.44 *[Revoked]*

Compare: Electricity Governance Rules 2003 rule 5 section IV part C

Clause 8.44: substituted, on 10 January 2013, by clause 20 of the Electricity Industry Participation (Policy Statement and Procurement Plan Review Process) Code Amendment 2012.

Clause 8.44(1), (4) and (6): amended, on 5 October 2017, by clause 98(1) of the Electricity Industry Participation Code Amendment (Code Review Programme) 2017.

Clause 8.44(2): amended, on 5 October 2017, by clause 98(2) of the Electricity Industry Participation Code Amendment (Code Review Programme) 2017.

Clause 8.44: revoked, on 1 August 2023, by clause 25 of the Electricity Industry Participation Code Amendment (System Operation Documents) 2023.

8.44A *[Revoked]*

Clause 8.44A: inserted, on 10 January 2013, by clause 21 of the Electricity Industry Participation (Policy Statement and Procurement Plan Review Process) Code Amendment 2012.

Clause 8.44A(4)(a) and (6): amended, on 5 October 2017, by clause 99 of the Electricity Industry Participation Code Amendment (Code Review Programme) 2017.

Clause 8.44A: revoked, on 1 August 2023, by clause 26 of the Electricity Industry Participation Code Amendment (System Operation Documents) 2023

8.44B *[Revoked]*

Clause 8.44B: inserted, on 10 January 2013, by clause 21 of the Electricity Industry Participation (Policy Statement and Procurement Plan Review Process) Code Amendment 2012.

Clause 8.44B(b): amended, on 5 October 2017, by clause 100 of the Electricity Industry Participation Code Amendment (Code Review Programme) 2017.

Clause 8.44B: revoked, on 1 August 2023, by clause 27 of the Electricity Industry Participation Code Amendment (System Operation Documents) 2023

8.45 Contracts with ancillary service agents

- (1) The **system operator** must use reasonable endeavours to implement the **procurement plan** for each **ancillary service** by entering into contracts with the **ancillary service agents** in the manner specified in the **procurement plan**.
- (2) The **system operator** is the principal in any contract it enters into with an **ancillary service agent**.
- (3) If the **system operator** has entered into a contract, the **system operator** must use reasonable endeavours to ensure that the **ancillary service agent** complies with its contractual obligations, but the **system operator** is not otherwise liable in respect of

any failure by an **ancillary service agent** to comply with such obligations.

Compare: Electricity Governance Rules 2003 rule 6 section IV part C

8.45A Methodology to assess net purchase quantity

The **system operator** must make the **net purchase quantity assessment** for each relevant **ancillary service** using the methodology in the **procurement plan** and **publish** the results of the assessment as soon as practicable.

Clause 8.45A: inserted, on 10 January 2013, by clause 22 of the Electricity Industry Participation (Policy Statement and Procurement Plan Review Process) Code Amendment 2012.

Clause 8.45A: amended, on 5 October 2017, by clause 101 of the Electricity Industry Participation Code Amendment (Code Review Programme) 2017.

8.46 [Revoked]

Compare: Electricity Governance Rules 2003 rule 7 section IV part C

Clause 8.46: revoked, on 10 January 2013, by clause 23 of the Electricity Industry Participation (Policy Statement and Procurement Plan Review Process) Code Amendment 2012.

8.47 Departure from procurement plan

- (1) The **system operator** may depart from the processes and arrangements set out in the **procurement plan** if the **system operator** reasonably considers it necessary to do so to comply with the **principal performance obligations**.
- (2) When the **system operator** makes a departure under subclause (1), the **system operator** must provide a report to the **Authority** setting out the circumstances of the departure and the actions taken to deal with it.
- (3) The **Authority** must **publish** the report within a reasonable time after receiving it.

Compare: Electricity Governance Rules 2003 rule 8 section IV part C

Clause 8.47(2): amended, on 10 January 2013, by clause 24(a) of the Electricity Industry Participation (Policy Statement and Procurement Plan Review Process) Code Amendment 2012.

Clause 8.47(3): inserted, on 10 January 2013, by clause 24(b) of the Electricity Industry Participation (Policy Statement and Procurement Plan Review Process) Code Amendment 2012.

Clause 8.47(3): amended, on 5 October 2017, by clause 102 of the Electricity Industry Participation Code Amendment (Code Review Programme) 2017.

Alternative ancillary service arrangements

8.48 Alternative ancillary service arrangements

- (1) If an **asset owner** wishes to have an **alternative ancillary service arrangement** authorised by the **system operator**, that **asset owner** (or, if more than 1 **asset owner** wishes to have an authorisation, those **asset owners** jointly) may apply to the **system operator** to have that arrangement authorised as an **alternative ancillary service arrangement** using the process set out in Schedule 8.2.
- (2) The **system operator** must authorise the arrangement as an **alternative ancillary service arrangement** if—
 - (a) the proposed arrangement complies with the technical requirements for that **ancillary service** as set out in the current **procurement plan**; and
 - (b) the implementation of the proposed arrangement will make the **ancillary service** available for **dispatch** by the **system operator** in substantially the same manner as if the **ancillary service** had been procured in accordance with the **procurement plan**.

- (3) As a condition of authorising an **alternative ancillary service arrangement** under subclause (2), the **system operator** may do 1 or more of the following:
- (a) require the **asset owner** to enter into arrangements with the **system operator** to ensure that the **system operator** can continue to meet the **principal performance obligations**;
 - (b) specify the date on which the **alternative ancillary service arrangement** commences;
 - (c) impose any other condition it reasonably believes is necessary, including conditions necessary for the **system operator** to meet its **principal performance obligations** and conditions necessary for the orderly reconciliation and settlement of **ancillary services**.

Compare: Electricity Governance Rules 2003 rules 9.1 to 9.3 section IV part C

8.49 Suspension of alternative ancillary service arrangement

- (1) An **asset owner** may at any time give written reasonable notice to the **system operator** of suspension of the **alternative ancillary service arrangement** for a period specified in the notice.
- (2) The **system operator** may suspend an **alternative ancillary service arrangement** in a **system security situation**.

Compare: Electricity Governance Rules 2003 rule 9.4 section IV part C

8.50 Modification of alternative ancillary service arrangement

An **asset owner** may apply to the **system operator** for a modification to an **alternative ancillary service arrangement** in which case clauses 8.51 to 8.53 and Schedule 8.2 apply.

Compare: Electricity Governance Rules 2003 rule 9.5 section IV part C

8.51 Cancellation of alternative ancillary service arrangement

An **asset owner** may at any time give reasonable notice in writing to the **system operator** of cancellation of the **alternative ancillary service arrangement**, which comes into effect on the date specified in the notice.

Compare: Electricity Governance Rules 2003 rule 9.6 section IV part C

8.52 Revocation of alternative ancillary service arrangements

- (1) The **system operator** may revoke authorisation of the **alternative ancillary service arrangement** as the **system operator** reasonably considers appropriate, if at any time after the **system operator** has authorised an **alternative ancillary service arrangement**, the **system operator** is satisfied that 1 or more of the following factors apply:
 - (a) the **alternative ancillary service arrangement** was authorised on information that was false or materially misleading;
 - (b) a prerequisite of the **alternative ancillary service arrangement** has changed;
 - (c) a condition upon which the authorisation was granted has not been complied with;
 - (d) such revocation is provided for under the terms of the authorisation.
- (2) Subject to clause 8.49(2), the **system operator** must not revoke or amend an

alternative ancillary service arrangement unless—

- (a) the person to whom the authorisation was granted and any other person who, in the opinion of the **system operator**, is likely to have an interest in the matter, is given reasonable notice of the **system operator's** intentions and a reasonable opportunity to make submissions to the **system operator**; and
- (b) the **system operator** has had regard to those submissions.

Compare: Electricity Governance Rules 2003 rule 9.7 section IV part C

8.53 Appeal of system operator decisions

- (1) An applicant may appeal any decision of the **system operator** in relation to any **alternative ancillary service arrangement**.
- (2) A **participant** may appeal any decision of the **system operator** in relation to an **alternative ancillary service arrangement** on the grounds set out in subclause (4).
- (3) An appeal must be commenced with the **Rulings Panel** by giving written notice to the **Authority**, specifying the grounds of appeal. A notice must be given within 10 **business days** of **publication** of the decision in the **system operator register** under clause 4 of Schedule 8.2.
- (4) For the purpose of subclause (2), an appeal may be made on the grounds that—
 - (a) the **system operator** made an error of fact, or failed to take properly into account all relevant information or took into account irrelevant information, and such error, failure or irrelevancy was material to the decision; or
 - (b) the conditions imposed on the **alternative ancillary service arrangement** are onerous, unnecessary or impose extra costs if appropriate alternatives exist.
- (5) The **Rulings Panel**, in determining an appeal, must either approve the decision of the **system operator** or direct the **system operator** to reconsider the decision in full or by reference to specified matters.
- (6) Pending the outcome of an appeal, the decision of the **system operator** in relation to the authorisation of an **alternative ancillary service arrangement** remains valid and can be acted upon by the relevant **asset owner**.

Compare: Electricity Governance Rules 2003 rule 9.8 section IV part C

8.54 Other provisions relating to alternative ancillary service arrangements

- (1) The **system operator** must monitor the performance of **alternative ancillary service arrangements** in accordance with the **procurement plan** and the monitoring regimes specified in the respective **alternative ancillary service arrangements**. If the **system operator** considers, on reasonable grounds, that an **alternative ancillary service arrangement** is not being, or likely not to be, complied with, the **system operator** must immediately advise the **asset owner**.
- (2) An **asset owner** who obtains an authorisation of an **alternative ancillary service arrangement** must comply with its obligations under the arrangement. If the **system operator** advises an **asset owner** under subclause (1), the **asset owner** must co-operate with the **system operator** and must immediately use reasonable endeavours to restore compliance as soon as possible.
- (3) An **asset owner** who holds an **alternative ancillary service arrangement** is relieved of

an obligation to pay costs for **ancillary service** in the manner provided for in clauses 8.55 to 8.59 and 8.64 to 8.70 to the extent provided for in the **alternative ancillary service arrangement**.

- (4) The holder of an **alternative ancillary service arrangement** breaches this Code if **ancillary services** are not made available to the **system operator** in accordance with the **alternative ancillary service arrangement**, or if an **alternative ancillary service arrangement** fails. From the date a breach of an **alternative ancillary service arrangement** becomes known, the holder of the **alternative ancillary service arrangement** must meet its share of the ancillary costs as if the **alternative ancillary service arrangement** had not been authorised.

Compare: Electricity Governance Rules 2003 rule 10 section IV part C

Clause 8.54(2): amended, on 1 November 2018, by clause 14 of the Electricity Industry Participation Code Amendment (Code Review Programme) 2018.

Subpart 4—Interruptible load

Heading: inserted, on 7 August 2014, by clause 9 of the Electricity Industry Participation Code Amendment (Extended Reserve) 2014.

8.54A Contents of this subpart

This subpart provides for the provision of information relating to **interruptible load**.

Clause 8.54A: inserted, on 7 August 2014, by clause 9 of the Electricity Industry Participation Code Amendment (Extended Reserve) 2014.

8.54AA System operator to maintain and publish register

- (1) The **system operator** must maintain and **publish** an up to date copy of the **system operator register**.
- (2) The up to date copy of the **system operator register published** under subclause (1) must be available to the public at all times up until a new up to date copy is **published**.

Clause 8.54AA: inserted, on 20 December 2021, by clause 11 of the Electricity Industry Participation Code Amendment (Code Review Programme) 2019.

8.54B Ancillary service agents to provide information about interruptible load

- (1) Each **ancillary service agent** that contracts for **interruptible load** in a **network** must, within 10 **business days** of entering into the contract, give the following **participants** the information in subclause (2):
- (a) if the **interruptible load** is contracted on a **local network**, the **connected asset owner** that operates the **local network**;
 - (b) if the **interruptible load** is contracted on an **embedded network**, the **connected asset owner** that operates the **local network** to which the **embedded network** is **connected**;
 - (c) if the **interruptible load** is contracted on the **grid**, the **grid owner** that owns or operates the part of the **grid** on which the **interruptible load** is contracted.
- (2) The information required is—
- (a) a list of the **ICPs** to which the contract relates; and
 - (b) the maximum **MW** that can be interrupted under the contract; and
 - (c) the commencement and expiry dates of the contract.

- (3) If an **ancillary service agent** has given a **connected asset owner** or **grid owner** information under subclause (1), the **connected asset owner** or **grid owner** may require the **ancillary service agent** to provide further information about the **interruptible load** to which the contract relates.
- (4) An **ancillary service agent** must comply with a requirement under subclause (3).
Clause 8.54B: inserted, on 7 August 2014, by clause 9 of the Electricity Industry Participation Code Amendment (Extended Reserve) 2014.
Clause 8.54B(1)(b): amended, on 23 February 2015, by clause 75 of the Electricity Industry Participation Code Amendment (Distributed Generation) 2014.
Clause 8.54B(1) and (3): amended, on 1 February 2016, by clause 11 of the Electricity Industry Participation Code Amendment (Code Review Programme) 2015.

Subpart 5—[Revoked]

Heading: inserted, on 7 August 2014, by clause 9 of the Electricity Industry Participation Code Amendment (Extended Reserve) 2014.
Heading: revoked, on 21 December 2021, by clause 12 of the Electricity Industry Participation Code Amendment (Automatic Under-Frequency Load Shedding Systems) 2021.

8.54C [Revoked]

Clause 8.54C: inserted, on 7 August 2014, by clause 9 of the Electricity Industry Participation Code Amendment (Extended Reserve) 2014.
Clause 8.54C: revoked, on 21 December 2021, by clause 12 of the Electricity Industry Participation Code Amendment (Automatic Under-Frequency Load Shedding Systems) 2021.

8.54D [Revoked]

Clause 8.54D: inserted, on 7 August 2014, by clause 9 of the Electricity Industry Participation Code Amendment (Extended Reserve) 2014.
Clause 8.54D: revoked, on 21 December 2021, by clause 12 of the Electricity Industry Participation Code Amendment (Automatic Under-Frequency Load Shedding Systems) 2021.

8.54E [Revoked]

Clause 8.54E: inserted, on 7 August 2014, by clause 9 of the Electricity Industry Participation Code Amendment (Extended Reserve) 2014.
Clause 8.54E(2): amended, on 19 December 2014, by clause 10 of the Electricity Industry Participation Code Amendment (Minor Code Amendments) (No 3) 2014.
Clause 8.54E: revoked, on 21 December 2021, by clause 12 of the Electricity Industry Participation Code Amendment (Automatic Under-Frequency Load Shedding Systems) 2021.

8.54F [Revoked]

Clause 8.54F: inserted, on 7 August 2014, by clause 9 of the Electricity Industry Participation Code Amendment (Extended Reserve) 2014.
Clause 8.54F(3): amended, on 5 October 2017, by clause 103 of the Electricity Industry Participation Code Amendment (Code Review Programme) 2017.
Clause 8.54F: revoked, on 21 December 2021, by clause 12 of the Electricity Industry Participation Code Amendment (Automatic Under-Frequency Load Shedding Systems) 2021.

8.54G [Revoked]

Clause 8.54G: inserted, on 7 August 2014, by clause 9 of the Electricity Industry Participation Code Amendment (Extended Reserve) 2014.
Clause 8.54G(3)(g): amended, on 5 October 2017, by clause 104(1) of the Electricity Industry Participation Code Amendment (Code Review Programme) 2017.
Clause 8.54G(3)(h): revoked, on 5 October 2017, by clause 104(2) of the Electricity Industry Participation Code Amendment (Code Review Programme) 2017.
Clause 8.54G(3A): inserted, on 5 October 2017, by clause 104(3) of the Electricity Industry Participation Code Amendment (Code Review Programme) 2017.

Electricity Industry Participation Code 2010
Part 8

Clause 8.54G: revoked, on 21 December 2021, by clause 12 of the Electricity Industry Participation Code Amendment (Automatic Under-Frequency Load Shedding Systems) 2021.

8.54H *[Revoked]*

Clause 8.54H: inserted, on 7 August 2014, by clause 9 of the Electricity Industry Participation Code Amendment (Extended Reserve) 2014.

Clause 8.54H: revoked, on 21 December 2021, by clause 12 of the Electricity Industry Participation Code Amendment (Automatic Under-Frequency Load Shedding Systems) 2021.

8.54I *[Revoked]*

Clause 8.54I: inserted, on 7 August 2014, by clause 9 of the Electricity Industry Participation Code Amendment (Extended Reserve) 2014.

Clause 8.54I: revoked, on 21 December 2021, by clause 12 of the Electricity Industry Participation Code Amendment (Automatic Under-Frequency Load Shedding Systems) 2021.

8.54J *[Revoked]*

Clause 8.54J: inserted, on 7 August 2014, by clause 9 of the Electricity Industry Participation Code Amendment (Extended Reserve) 2014.

Clause 8.54J(2): amended, on 19 December 2014, by clause 11 of the Electricity Industry Participation Code Amendment (Minor Code Amendments) (No 3) 2014.

Clause 8.54J(12): inserted, on 19 January 2017, by clause 6 of the Electricity Industry Participation Code Amendment (Extended Reserve) 2016.

Clause 8.54J: revoked, on 21 December 2021, by clause 12 of the Electricity Industry Participation Code Amendment (Automatic Under-Frequency Load Shedding Systems) 2021.

8.54K *[Revoked]*

Clause 8.54K: inserted, on 7 August 2014, by clause 9 of the Electricity Industry Participation Code Amendment (Extended Reserve) 2014.

Clause 8.54K(1): amended, on 19 January 2017, by clause 7(1) of the Electricity Industry Participation Code Amendment (Extended Reserve) 2016.

Clause 8.54K(2): replaced, on 19 January 2017, by clause 7(2) of the Electricity Industry Participation Code Amendment (Extended Reserve) 2016.

Clause 8.54K: revoked, on 21 December 2021, by clause 12 of the Electricity Industry Participation Code Amendment (Automatic Under-Frequency Load Shedding Systems) 2021.

8.54L *[Revoked]*

Clause 8.54L: inserted, on 7 August 2014, by clause 9 of the Electricity Industry Participation Code Amendment (Extended Reserve) 2014.

Clause 8.54L: revoked, on 21 December 2021, by clause 12 of the Electricity Industry Participation Code Amendment (Automatic Under-Frequency Load Shedding Systems) 2021.

8.54M *[Revoked]*

Clause 8.54M: inserted, on 7 August 2014, by clause 9 of the Electricity Industry Participation Code Amendment (Extended Reserve) 2014.

Clause 8.54M: revoked, on 21 December 2021, by clause 12 of the Electricity Industry Participation Code Amendment (Automatic Under-Frequency Load Shedding Systems) 2021.

8.54N *[Revoked]*

Clause 8.54N: inserted, on 7 August 2014, by clause 9 of the Electricity Industry Participation Code Amendment (Extended Reserve) 2014.

Clause 8.54N: amended, on 19 January 2017, by clause 8 of the Electricity Industry Participation Code Amendment (Extended Reserve) 2016.

Clause 8.54N: revoked, on 21 December 2021, by clause 12 of the Electricity Industry Participation Code Amendment (Automatic Under-Frequency Load Shedding Systems) 2021.

8.54O *[Revoked]*

Clause 8.54O: inserted, on 7 August 2014, by clause 9 of the Electricity Industry Participation Code Amendment (Extended Reserve) 2014.

Clause 8.54O(3)(c): amended, on 19 January 2017, by clause 9(1) of the Electricity Industry Participation Code Amendment (Extended Reserve) 2016.

Clause 8.54O(5): inserted, on 19 January 2017, by clause 9(2) of the Electricity Industry Participation Code Amendment (Extended Reserve) 2016.

Clause 8.54O: revoked, on 21 December 2021, by clause 12 of the Electricity Industry Participation Code Amendment (Automatic Under-Frequency Load Shedding Systems) 2021.

8.54P *[Revoked]*

Clause 8.54P: inserted, on 7 August 2014, by clause 9 of the Electricity Industry Participation Code Amendment (Extended Reserve) 2014.

Clause 8.54P: revoked, on 21 December 2021, by clause 12 of the Electricity Industry Participation Code Amendment (Automatic Under-Frequency Load Shedding Systems) 2021.

8.54Q *[Revoked]*

Clause 8.54Q: inserted, on 7 August 2014, by clause 9 of the Electricity Industry Participation Code Amendment (Extended Reserve) 2014.

Clause 8.54Q heading: amended, on 19 December 2014, by clause 12(1) of the Electricity Industry Participation Code Amendment (Minor Code Amendments) (No 3) 2014.

Clause 8.54Q heading: amended, on 19 January 2017, by clause 10(1) of the Electricity Industry Participation Code Amendment (Extended Reserve) 2016.

Clause 8.54Q heading: amended, on 5 October 2017, by clause 105(1) of the Electricity Industry Participation Code Amendment (Code Review Programme) 2017.

Clause 8.54Q(1) and (2)(b): amended, on 19 December 2014, by clause 12(2) of the Electricity Industry Participation Code Amendment (Minor Code Amendments) (No 3) 2014.

Clause 8.54Q(1) and (2)(b): amended, on 19 January 2017, by clause 10(2) of the Electricity Industry Participation Code Amendment (Extended Reserve) 2016.

Clause 8.54Q(1) and (2)(b): amended, on 5 October 2017, by clause 105(2) of the Electricity Industry Participation Code Amendment (Code Review Programme) 2017.

Clause 8.54Q: revoked, on 21 December 2021, by clause 12 of the Electricity Industry Participation Code Amendment (Automatic Under-Frequency Load Shedding Systems) 2021.

8.54R *[Revoked]*

Clause 8.54R: inserted, on 7 August 2014, by clause 9 of the Electricity Industry Participation Code Amendment (Extended Reserve) 2014.

Clause 8.54R heading: amended, on 19 December 2014, by clause 13 of the Electricity Industry Participation Code Amendment (Minor Code Amendments) (No 3) 2014.

Clause 8.54R: revoked, on 21 December 2021, by clause 12 of the Electricity Industry Participation Code Amendment (Automatic Under-Frequency Load Shedding Systems) 2021.

8.54S *[Revoked]*

Clause 8.54S: inserted, on 7 August 2014, by clause 9 of the Electricity Industry Participation Code Amendment (Extended Reserve) 2014.

Clause 8.54S Heading: amended, on 1 February 2016, by clause 12(1) of the Electricity Industry Participation Code Amendment (Code Review Programme) 2015.

Clause 8.54S(1) & (2): amended, on 1 February 2016, by clause 12(2) of the Electricity Industry Participation Code Amendment (Code Review Programme) 2015.

Clause 8.54S: revoked, on 21 December 2021, by clause 12 of the Electricity Industry Participation Code Amendment (Automatic Under-Frequency Load Shedding Systems) 2021.

8.54T *[Revoked]*

Clause 8.54T: inserted, on 7 August 2014, by clause 9 of the Electricity Industry Participation Code Amendment (Extended Reserve) 2014.

Clause 8.54T(4): amended, on 19 December 2014, by clause 14 of the Electricity Industry Participation Code Amendment (Minor Code Amendments) (No 3) 2014.

Clause 8.54T(4): amended, on 5 October 2017, by clause 106 of the Electricity Industry Participation Code Amendment (Code Review Programme) 2017.

Clause 8.54T: revoked, on 21 December 2021, by clause 12 of the Electricity Industry Participation Code Amendment (Automatic Under-Frequency Load Shedding Systems) 2021.

8.54TA *[Revoked]*

Clause 8.54TA: inserted, on 19 January 2017, by clause 11 of the Electricity Industry Participation Code Amendment (Extended Reserve) 2016.

Clause 8.54TA: revoked, on 21 December 2021, by clause 12 of the Electricity Industry Participation Code Amendment (Automatic Under-Frequency Load Shedding Systems) 2021.

8.54TB *[Revoked]*

Clause 8.54TB: inserted, on 19 January 2017, by clause 11 of the Electricity Industry Participation Code Amendment (Extended Reserve) 2016.

Clause 8.54TB: revoked, on 21 December 2021, by clause 12 of the Electricity Industry Participation Code Amendment (Automatic Under-Frequency Load Shedding Systems) 2021.

8.54TC *[Revoked]*

Clause 8.54TC: inserted, on 19 January 2017, by clause 11 of the Electricity Industry Participation Code Amendment (Extended Reserve) 2016.

Clause 8.54TC: revoked, on 21 December 2021, by clause 12 of the Electricity Industry Participation Code Amendment (Automatic Under-Frequency Load Shedding Systems) 2021.

8.54TD *[Revoked]*

Clause 8.54TD: inserted, on 19 January 2017, by clause 11 of the Electricity Industry Participation Code Amendment (Extended Reserve) 2016.

Clause 8.54TD: revoked, on 21 December 2021, by clause 12 of the Electricity Industry Participation Code Amendment (Automatic Under-Frequency Load Shedding Systems) 2021.

8.54TE *[Revoked]*

Clause 8.54TE: inserted, on 5 October 2017, by clause 107 of the Electricity Industry Participation Code Amendment (Code Review Programme) 2017.

Clause 8.54TE: revoked, on 21 December 2021, by clause 12 of the Electricity Industry Participation Code Amendment (Automatic Under-Frequency Load Shedding Systems) 2021.

8.54TF *[Revoked]*

Clause 8.54TF: inserted, on 5 October 2017, by clause 107 of the Electricity Industry Participation Code Amendment (Code Review Programme) 2017.

Clause 8.54TF: revoked, on 21 December 2021, by clause 12 of the Electricity Industry Participation Code Amendment (Automatic Under-Frequency Load Shedding Systems) 2021.

Subpart 6—Allocating costs

Heading: inserted, on 24 March 2015, by clause 10 of the Electricity Industry Participation Code Amendment (Extended Reserve) 2014.

8.54U Contents of this subpart

This subpart provides for the allocation of costs relating to **ancillary services**.

Clause 8.54U: inserted, on 24 March 2015, by clause 10 of the Electricity Industry Participation Code Amendment (Extended Reserve) 2014.

Clause 8.54U: amended, on 21 December 2021, by clause 13 of the Electricity Industry Participation Code Amendment (Automatic Under-Frequency Load Shedding Systems) 2021.

Allocating costs for ancillary services

Cross heading: amended, on 24 March 2015, by clause 11 of the Electricity Industry Participation Code Amendment (Extended Reserve) 2014.

Cross heading: amended, on 21 December 2021, by clause 14 of the Electricity Industry Participation Code Amendment (Automatic Under-Frequency Load Shedding Systems) 2021.

8.55 Identifying costs associated with ancillary services

(1) The **allocable costs** for each **ancillary service** are—

- (a) the actual amounts that the **ancillary service agents** are entitled to receive for that **ancillary service** under contracts entered into by the **system operator** in implementing the **procurement plan**; plus
- (b) the actual **administrative costs** of the **system operator** (as approved by the **Authority**) incurred in administering the **procurement plan** in respect of that **ancillary service**; less
- (c) any readily identifiable and quantifiable costs to be paid by **asset owners** in respect of that **ancillary service** as a condition of any **dispensations** stipulated in accordance with clause 8.31(1)(a); less
- (d) any identifiable costs to be paid by any person in respect of that **ancillary service**, as a condition of any agreement reached by the **system operator**, in accordance with clause 8.6.

(2) *[Revoked]*

Compare: Electricity Governance Rules 2003 rule 11.1 section IV part C

Clause 8.55 heading: amended, on 24 March 2015, by clause 12(1) of the Electricity Industry Participation Code Amendment (Extended Reserve) 2014.

Clause 8.55 heading: amended, on 21 December 2021, by clause 15(1) of the Electricity Industry Participation Code Amendment (Automatic Under-Frequency Load Shedding Systems) 2021.

Clause 8.55(2): inserted, on 24 March 2015, by clause 12(2) of the Electricity Industry Participation Code Amendment (Extended Reserve) 2014.

Clause 8.55(2): revoked, on 21 December 2021, by clause 15(2) of the Electricity Industry Participation Code Amendment (Automatic Under-Frequency Load Shedding Systems) 2021.

8.56 Black start costs allocated to grid owner

The **allocable cost** of **black start** must be paid by the **registered participants** who are **grid owners** to the **system operator** in accordance with the process described in clause 8.68. If there are multiple **grid owners**, those costs must be allocated between them in proportion to their respective ODV valuations.

Compare: Electricity Governance Rules 2003 rule 11.2 section IV part C

8.57 Over frequency reserve costs allocated to HVDC owner

The **allocable cost** of **over frequency reserve** must be paid by the **HVDC owner** to the **system operator** in accordance with the process described in clause 8.68.

Compare: Electricity Governance Rules 2003 rule 11.3 section IV part C

8.58 Frequency keeping costs are allocated to purchasers

The **allocable cost** of **frequency keeping** must be paid by **purchasers** to the **system operator** in accordance with the process in clause 8.68. Those costs must be calculated in accordance with the following formula:

$$\text{Share}_{\text{PURx}} = \frac{F_c * \max(0, \sum_t (\text{Offtake}_{\text{PURxt}} - E_{\text{PURxt}}^{\text{FK}}))}{\sum_x \max(0, \sum_t (\text{Offtake}_{\text{PURxt}} - E_{\text{PURxt}}^{\text{FK}}))}$$

where

$\text{Share}_{\text{PURx}}$ is **purchaser x's share of allocable cost** in relation to **frequency keeping**

F_c is the **allocable cost of frequency keeping services** in the **billing period**

$Offtake_{PURxt}$ is the total **reconciled quantity** in **kWh** for **purchaser x** across all **grid exit points** in **trading period t** in the **billing period**

E_{PURxt}^{FK} is the quantity of any **frequency keeping** provided under any **alternative ancillary service arrangement** for **frequency keeping** authorised by the **system operator** for **purchaser x** in **trading period t**.

Compare: Electricity Governance Rules 2003 rule 11.4 section IV part C

8.59 Availability costs allocated to generators and HVDC owner

The **availability costs** in a **billing period** must be allocated separately to persons in the North Island and South Island in accordance with the following formula:

$$Share_t = \frac{Ac_t * m_t}{M_t}$$

where

$Share_t$ is the **availability cost** allocated to a **generator** who owns **generating unit x** or to the **HVDC link** for **trading period t** for the North Island or South Island as appropriate

Ac_t is the **availability cost** for the North Island or South Island as appropriate incurred in respect of **trading period t**

m_t $\left\{ \begin{array}{l} \text{is } \max(0, INJ_{GENxt} - (h * INJ_D) - E_{GENxt}^{IR}) = m_{xt} \text{ for any } \mathbf{generating\ unit} \\ \text{is } \max(0, HVDC_{Riskt} - (h * INJ_D) - E_{HVDCt}^{IR}) = m_{ht} \text{ for the } \mathbf{HVDC\ link} \end{array} \right.$

M_t is $\sum_x m_{xt} + m_{ht}$

h is **0.5 MWh/MW**

INJ_{GENxt} is the **electricity injected** (expressed in **MWh**) by **generating unit x** in **trading period t** into the North Island or South Island as appropriate

E_{GENxt}^{IR} is the quantity of any **instantaneous reserve** provided under any **alternative ancillary service arrangements** for **instantaneous reserve** authorised by the **system operator** for **generating unit x** in **trading period t**

$HVDC_{Riskt}$ is the **at risk HVDC transfer** (expressed in **MWh**) in **trading period t** into the North Island or South Island as appropriate

E_{HVDCt}^{IR} is the quantity of any **instantaneous reserve** provided under any **alternative ancillary service arrangement** for **instantaneous reserve** authorised by the **system operator** for **at risk HVDC transfer** in **trading period t**

INJ_D is **60 MW**.

Compare: Electricity Governance Rules 2003 rule 11.5.1 section IV part C

8.60 System operator must investigate causer of under-frequency event

- (1) The **system operator** must promptly advise the **Authority**, every **generator**, **grid owner** and any other **participant** substantially affected by an **under-frequency event**, that an **under-frequency event** has occurred.
- (2) The **system operator** may, by notice in writing to a **participant**, require a **participant** to provide information required by the **system operator** for the purposes of this clause.
- (3) A notice given under subclause (2) must specify the information required by the **system operator** and the date by which the information must be provided (which must not be earlier than 20 **business days** after the notice is given).
- (4) A **participant** who has received a notice under subclause (2) must provide the information required by the **system operator** by the date specified by the **system operator** in the notice.
- (5) Within 40 **business days** of receiving the information, or such longer period as may be agreed by the **Authority**, the **system operator** must provide a report to the **Authority** that includes the following:
 - (a) whether, in the **system operator's** view, the **under-frequency event** was caused by a **generator** or **grid owner**, and if so, the identity of the **causer**;
 - (b) the reasons for the **system operator's** view;
 - (c) all of the information the **system operator** considered in reaching its view.

Compare: Electricity Governance Rules 2003 rule 11.5.1A section IV part C

Clause 8.60 Heading: amended, on 19 May 2016, by clause 25(1) of the Electricity Industry Participation Code Amendment (System Operator and Alignment with Statutory Objective) 2016.

Clause 8.60(1): amended, on 19 May 2016, by clause 25(2) of the Electricity Industry Participation Code Amendment (System Operator and Alignment with Statutory Objective) 2016.

Clause 8.60(1): amended, on 1 November 2018, by clause 15 of the Electricity Industry Participation Code Amendment (Code Review Programme) 2018.

Clause 8.60(2): amended, on 19 May 2016, by clause 25(3)(a), (b) and (c) of the Electricity Industry Participation Code Amendment (System Operator and Alignment with Statutory Objective) 2016.

Clause 8.60(3): amended, on 19 May 2016, by clause 25(4)(a) and (b) of the Electricity Industry Participation Code Amendment (System Operator and Alignment with Statutory Objective) 2016.

Clause 8.60(5): inserted, on 19 May 2016, by clause 25(5) of the Electricity Industry Participation Code Amendment (System Operator and Alignment with Statutory Objective) 2016.

8.61 Authority to determine causer of under-frequency event

- (1) The **Authority** must determine whether an **under-frequency event** has been caused by a **generator** or **grid owner** and, if so, the identity of the **causer**.
- (2) The **Authority** must **publish** a draft determination that states whether the **under-frequency event** was caused by a **generator** or **grid owner** and, if so, the identity of the **causer**.
- (3) The **Authority** must give reasons for its findings in the draft determination.
- (4) The **Authority** must consult every **generator**, **grid owner** and other **participant** substantially affected by an **under-frequency event** in relation to the draft determination.
- (5) When the **Authority publishes** the draft determination under subclause (2), the **Authority** must give notice to **generators**, **grid owners**, and other **participants** substantially affected by the **under-frequency event** of the closing date for submissions on the draft determination.

- (6) The date referred to in subclause (5) must be no earlier than 10 **business days** after the date of **publication** of the draft determination.
- (7) The **Authority** must **publish** submissions received under subclause (4) unless there is good reason for withholding information in a submission.
- (8) For the purposes of subclause (7), good reason for withholding information exists if there is good reason for withholding the information under the Official Information Act 1982.
- (9) Following the consultation under subclause (4), the **Authority** must **publish** a final determination.

Compare: Electricity Governance Rules 2003 rule 11.5.1B section IV part C

Clause 8.61 Heading: amended, on 19 May 2016, by clause 26(1) of the Electricity Industry Participation Code Amendment (System Operator and Alignment with Statutory Objective) 2016.

Clause 8.61: amended, on 19 May 2016, by clause 26(2) of the Electricity Industry Participation Code Amendment (System Operator and Alignment with Statutory Objective) 2016.

Clause 8.61(1): amended, on 19 May 2016, by clause 26(3) of the Electricity Industry Participation Code Amendment (System Operator and Alignment with Statutory Objective) 2016.

Clause 8.61(5): amended, on 19 May 2016, by clause 26(4)(a) and (b) of the Electricity Industry Participation Code Amendment (System Operator and Alignment with Statutory Objective) 2016.

8.62 Disputes regarding Authority determinations

- (1) A **participant** who is substantially affected by a determination may dispute the determination by referring the matter to the **Rulings Panel**.
- (2) A dispute is commenced by giving written notice to the **Rulings Panel** specifying the grounds of the dispute.
- (3) A notice under subclause (2) must be given within 10 **business days** after the determination is **published**.
- (4) The **Authority's** determination is suspended if a dispute is referred to the **Rulings Panel** within that time.
- (5) If a dispute is not referred to the **Rulings Panel** within that time, the determination is final.
- (6) If a dispute is referred to the **Rulings Panel**, the **Authority** must provide the **Rulings Panel** with all information considered by the **Authority** in making the determination.

Compare: Electricity Governance Rules 2003 rule 11.5.1C section IV part C

Clause 8.62 Heading: amended, on 19 May 2016, by clause 27(1) of the Electricity Industry Participation Code Amendment (System Operator and Alignment with Statutory Objective) 2016.

Clause 8.62(1): amended, on 19 May 2016, by clause 27(2) of the Electricity Industry Participation Code Amendment (System Operator and Alignment with Statutory Objective) 2016.

Clause 8.62(3): amended, on 5 October 2017, by clause 108 of the Electricity Industry Participation Code Amendment (Code Review Programme) 2017.

Clause 8.62 (4): amended, on 19 May 2016, by clause 27(3) of the Electricity Industry Participation Code Amendment (System Operator and Alignment with Statutory Objective) 2016.

Clause 8.62(6): amended, on 19 May 2016, by clause 27(4) of the Electricity Industry Participation Code Amendment (System Operator and Alignment with Statutory Objective) 2016.

8.63 Decision of the Rulings Panel

- (1) The **Rulings Panel** may—
 - (a) confirm the determination; or
 - (b) amend the determination; or
 - (c) substitute its own determination; or
 - (d) refer the determination back to the **Authority** with directions as to the particular matters that require reconsideration or amendment.

- (2) The **Authority's** determination has effect as confirmed, amended, or substituted by the **Rulings Panel** from the date of the **Rulings Panel's** decision.
- (3) The **Rulings Panel** must give a copy of its decision to the **Authority** as soon as reasonably practicable.
- (4) The **Authority** must **publish** the **Rulings Panel's** decision as soon as reasonably practicable.
- (5) If the **Rulings Panel** refers the matter back to the **Authority**, the **Authority** must have regard to the **Rulings Panel's** directions under subclause (1)(d).

Compare: Electricity Governance Rules 2003 rule 11.5.1D section IV part C

Clause 8.63: amended, on 19 May 2016, by clause 28(1) of the Electricity Industry Participation Code Amendment (System Operator and Alignment with Statutory Objective) 2016.

Clause 8.63(3): amended, on 19 May 2016, by clause 28(2) of the Electricity Industry Participation Code Amendment (System Operator and Alignment with Statutory Objective) 2016.

8.64 Event costs allocated to event causers

The **event charge** payable by the **causer** of an **under-frequency event** (referred to as "Event e" below) must be calculated in accordance with the following formula:

$$EC = ECR * (\sum_y (INT_{ye} \text{ for all } y) - INJ_D)$$

where

EC is the **event charge** payable by the **causer**

ECR is \$1,250 per **MW**

INJ_D is 60 **MW**

INT_{ye} is the electric power (expressed in **MW**) lost at point y by reason of Event e (being the net reduction in the **injection of electricity** (expressed in **MW**) experienced at point y by reason of Event e) excluding any loss at point y by reason of secondary Event e

y is a **point of connection** or the **HVDC injection point** at which the **injection of electricity** was interrupted or reduced by reason of Event e.

Compare: Electricity Governance Rules 2003 rule 11.5.2 section IV part C

Clause 8.64: amended, on 21 September 2012, by clause 10 of the Electricity Industry Participation (Minor Amendments) Code Amendment 2012.

8.65 Rebates paid for under-frequency events

An **event charge** that has been paid for an **under-frequency event** (referred to as "Event e") under clause 8.64 must be rebated in accordance with the following formula to persons who are allocated **availability costs** in accordance with clause 8.59:

$$\text{Rebate}_{xe} = EC_e * Z_{xe}/Z_{tote}$$

where

Rebate_{xe} is the rebate of the **event charge** paid for Event e to person "x", who

has been allocated **availability costs** in accordance with clause 8.59

EC_e is the **event charge** paid for Event e

Z_{xe} is the sum of all **availability costs** paid by x during the **billing period** in which Event e occurred and the 2 preceding **billing periods**

Z_{tote} is the sum of all **availability costs** paid for all **trading periods** during the **billing period** in which Event e occurred and the two preceding **billing periods**.

Compare: Electricity Governance Rules 2003 rule 11.5.3 section IV part C

8.66 Payments and rebates

All costs calculated in accordance with clauses 8.59 and 8.64 are payable by the relevant **participants** to the **system operator**, and all **event charge** rebates calculated in accordance with clause 8.65 are payable by the **system operator** to the relevant **participants**, in accordance with clause 8.69.

Compare: Electricity Governance Rules 2003 rule 11.5.4 section IV part C

8.67 Voltage support costs allocated in 3 parts – nominated peak, monthly peak and residual charges

- (1) Each **connected asset owner** must pay the **allocable cost of voltage support** in each **zone** to the **system operator** in accordance with clause 8.68. The costs must be calculated in accordance with this clause.
- (2) Each **connected asset owner** must pay a nominated peak kvar charge calculated in accordance with the following formula:

$$\text{NomCharge}_{xz} = \text{PeakRate}_z * \sum_j Q_{xjz}$$

where

NomCharge_{xz} is the total nominated peak charges for **connected asset owner x** in **zone z**

Peak Rate_z is the fixed \$/kvar set annually in advance by **system operator** for **zone z**

Q_{xjz} is $\text{Nom Peak}_{\text{LINES}_{xjz}}$, which is the peak demand in kvar (in **zone z**) nominated to the **system operator** in advance of, and having effect from, 1 March each year by **connected asset owner x** at its **connected asset owner kvar reference node j**

\sum_j is the sum across all **connected asset owner kvar reference nodes j** of **connected asset owner x** in **zone z**

- (3) Each **connected asset owner** must pay a monthly peak penalty charge calculated in accordance with the following formula:

$$\text{PeakPenaltyCharge}_{\text{LINE}_{xz}} = \text{PenaltyRate}_z * \sum_j \text{PenaltyQuantity}_{\text{LINE}_{xjz}}$$

where

$\text{PeakPenaltyCharge}_{\text{LINE}_{xz}}$ is the total peak penalty charges for **connected asset owner x** across all **connected asset owner kvar reference nodes j** for **connected asset owner x** in **zone z**

PenaltyRate_z is the fixed \$/kvar penalty charge for “kvar above nominated kvar” set annually in advance by the **system operator** in **zone z**

\sum_j is the sum across all **connected asset owner kvar reference nodes j** of **connected asset owner x** in **zone z**

$\text{PenaltyQuantity}_{\text{LINE}_{xjz}}$ is the “kvar above nominated kvar” quantity for **connected asset owner x** at its **connected asset owner kvar reference node j** in **zone z**

- (4) For the purpose of calculating the “kvar above nominated kvar” quantity, the kvar taken by the **connected asset owner**—
- (a) includes only kvar demands on weekdays (Monday to Friday but excluding **national holidays**) between the hours of 0700 to 2100 inclusive; and
 - (b) includes no more than 2 kvar peaks in any 1 day; and
 - (c) is the average of the 6 largest kvar peaks for the **connected asset owner** in each month measured at the **connected asset owner kvar reference node j** within the **zone z**,—

and “kvar above nominated kvar” is the difference between the kvar taken by the **connected asset owners** as determined in accordance with paragraphs (a) to (c) and the nominated kvar specified by the **connected asset owner**.

- (5) Each **connected asset owner** must pay a residual charge or receive a residual payment calculated in accordance with the following formulae:

$$\text{Residual}_{\text{ALL}z} = \text{Vcost}_z - \text{Nom Charge}_{\text{ALL}z} - \text{PeakPenaltyCharge}_{\text{ALL}z}$$

$$\text{Residual}_{\text{LINE}_{allz}} = \text{Residual}_{\text{ALL}z} * (\sum_{xj} \text{NomPeak}_{\text{LINE}_{xjz}} / \sum_{xj} Q_{xjz})$$

$$\text{Residual}_{\text{LINE}_{xz}} = \text{Residual}_{\text{LINE}_{allz}} * (\text{BillingPeriodOfftake}_{\text{LINE}_{xz}} / \text{BillingPeriodOfftake}_{\text{ALL}z})$$

where

Vcost_z is the total **allocable costs** for **voltage support** in **zone z** in the **billing period**

$\text{Nom Charge}_{\text{ALL}z}$ is the sum of all Nom Charge_{xz} for **zone z**

PeakPenaltyCharge _{ALLz}	is the sum of all connected asset owners' PeakPenaltyCharge _{LINExz} for zone z
Residual _{ALLz}	is the total residual to be recovered from or paid to connected asset owners in zone z
Residual _{LINeallz}	is the portion of Residual _{ALLz} to be recovered from or paid to connected asset owners in zone z
Residual _{LINExz}	is the portion of Residual _{LINeallz} to be recovered from or paid to connected asset owner x in zone z
BillingPeriodOfftake _{LINExz}	is the sum of metering information for connected asset owner x across all connected asset owner kvar reference nodes in zone z for the billing period for all trading periods
BillingPeriodOfftake _{ALLz}	is the sum of metering information for all connected asset owners across all connected asset owner kvar reference nodes in zone z for the billing period for all trading periods
Σ_{xj}	is the sum across all connected asset owner kvar reference nodes j for all connected asset owners x in zone z
Σ_j	is the sum across all connected asset owner kvar reference nodes j of connected asset owner x in zone z
Q_{xjz}	is Nom Peak _{LINExjz} , which is the peak demand in kvar (in zone z) nominated to the system operator in advance of, and having effect from, 1 March each year by connected asset owner x at its connected asset owner kvar reference node j

- (6) For the purposes of this clause, a **connected asset owner** does not include a **generator** who is supplied **electricity** for consumption at a **point of connection** with the **grid**.

Compare: Electricity Governance Rules 2003 rule 11.6 section IV part C

Clause 8.67: amended, on 1 February 2016, by clause 13 of the Electricity Industry Participation Code Amendment (Code Review Programme) 2015.

Clause 8.67(5): amended, on 15 May 2014, by clause 10 of the Electricity Industry Participation (Minor Code Amendments) Code Amendment 2014.

8.67A [Revoked]

Clause 8.67A: inserted, on 24 March 2015, by clause 13 of the Electricity Industry Participation Code Amendment (Extended Reserve) 2014.

Clause 8.67A Heading: amended, on 1 February 2016, by clause 14(1) of the Electricity Industry Participation Code Amendment (Code Review Programme) 2015.

Clause 8.67A: amended, on 1 February 2016, by clause 14(2) of the Electricity Industry Participation Code Amendment (Code Review Programme) 2015.

Clause 8.67A: amended, on 19 January 2017, by clause 12 of the Electricity Industry Participation Code Amendment (Extended Reserve) 2016.

Clause 8.67A: revoked, on 21 December 2021, by clause 16 of the Electricity Industry Participation Code Amendment (Automatic Under-Frequency Load Shedding Systems) 2021.

8.68 Clearing manager to determine amounts owing

- (1) The **clearing manager** must determine the amount owing to the **system operator** by each **grid owner, purchaser, generator and connected asset owner** for **ancillary services** under clauses 8.55 to 8.67. On behalf of the **system operator**, the **clearing manager** must collect those amounts, and any amounts advised by the **system operator** as owing to it under clauses 8.6 and 8.31(1)(a), by including the relevant amounts in the amounts advised by the **clearing manager** as owing under Part 14.
- (2) To enable the **clearing manager** to determine those amounts, the **system operator** must provide to the **clearing manager** the total **allocable cost** for each **ancillary service** and any additional information required to carry out the calculations under clauses 8.55 to 8.67 that is not otherwise provided by the **reconciliation manager** under Part 13.
- (3) *[Revoked]*
- (4) *[Revoked]*
- (5) *[Revoked]*
- (6) All amounts owing under this clause are subject to the priority order of payments set out in clause 14.56.

Compare: Electricity Governance Rules 2003 rule 11.7 section IV part C

Clause 8.68 heading: amended, on 24 March 2015, by clause 7(1) of the Electricity Industry Participation (Settlement and Prudential Security) Code Amendment 2013.

Clause 8.68(1): amended, on 24 March 2015, by clause 7(2) of the Electricity Industry Participation (Settlement and Prudential Security) Code Amendment 2013.

Clause 8.68(1): amended, on 24 March 2015, by clause 14(1) of the Electricity Industry Participation Code Amendment (Extended Reserve) 2014.

Clause 8.68(1): amended, on 1 February 2016, by clause 15 of the Electricity Industry Participation Code Amendment (Code Review Programme) 2015.

Clause 8.68(3), (4), (5) and (6): inserted, on 24 March 2015, by clause 14(2) of the Electricity Industry Participation Code Amendment (Extended Reserve) 2014.

Clause 8.68(3): amended, on 1 February 2016, by clause 15 of the Electricity Industry Participation Code Amendment (Code Review Programme) 2015.

Clause 8.68(3): amended, on 19 January 2017, by clause 13 of the Electricity Industry Participation Code Amendment (Extended Reserve) 2016.

Clause 8.68(3), (4) and (5): revoked, on 21 December 2021, by clause 17 of the Electricity Industry Participation Code Amendment (Automatic Under-Frequency Load Shedding Systems) 2021.

Clause 8.68(2): amended, on 1 November 2022, by clause 6 of the Electricity Industry Participation Code Amendment (Real Time Pricing) 2022.

8.69 Clearing manager to determine wash up amounts payable and receivable

- (1) The **clearing manager** must determine the following amounts owing as a result of **washups** under subpart 6 of Part 14:
 - (a) the amount owing to the **system operator** by each **grid owner, purchaser, generator and connected asset owner** for **ancillary services** under clauses 8.55 to 8.67:
 - (b) the amount owing to each **grid owner, purchaser, generator and connected asset owner** by the **system operator** for **ancillary services** under clauses 8.55 to 8.67:
 - (c) *[Revoked]*:
 - (d) *[Revoked]*.
- (2) On behalf of the **system operator** the **clearing manager** must collect or pay the

amounts owing for **ancillary services**, and any amounts advised by the **system operator** as payable to it under clauses 8.6 and 8.31(1)(a) by including the relevant amounts advised by the **clearing manager** as owing under Part 14.

- (3) To enable the **clearing manager** to determine the amounts payable for **ancillary services**, the **system operator** must provide to the **clearing manager** the **allocable cost** for each **ancillary service** and any additional information required to carry out the recalculations under clauses 8.55 to 8.67 that is not otherwise provided by the **reconciliation manager** under Part 13.
- (4) All amounts owing under this clause are subject to the priority order of payments set out in clause 14.56.

Compare: Electricity Governance Rules 2003 rule 11.8 section IV part C

Clause 8.69 heading: amended, on 24 March 2015, by clause 8(1) of the Electricity Industry Participation (Settlement and Prudential Security) Code Amendment 2013.

Clause 8.69: substituted, on 24 March 2015, by clause 15 of the Electricity Industry Participation Code Amendment (Extended Reserve) 2014.

Clause 8.69(1): amended, on 24 March 2015, by clause 8(2) of the Electricity Industry Participation (Settlement and Prudential Security) Code Amendment 2013.

Clause 8.69(1)(a) & (b): amended, on 1 February 2016, by clause 16(1) of the Electricity Industry Participation Code Amendment (Code Review Programme) 2015.

Clause 8.69(1)(c) and (d): revoked, on 21 December 2021, by clause 18 of the Electricity Industry Participation Code Amendment (Automatic Under-Frequency Load Shedding Systems) 2021.

Clause 8.69(4): amended, on 1 February 2016, by clause 16(2) of the Electricity Industry Participation Code Amendment (Code Review Programme) 2015.

Clause 8.69(3): amended, on 1 November 2022, by clause 7 of the Electricity Industry Participation Code Amendment (Real Time Pricing) 2022.

8.70 System operator pays ancillary service agents

- (1) The **system operator** must pay each **ancillary service agent** the amounts that each **ancillary service agent** is entitled to receive for **ancillary services** under contracts entered into by the **system operator** in implementing the **procurement plan**.
- (2) The **system operator** must use the **clearing manager** as its agent to pay **participants**.

Compare: Electricity Governance Rules 2003 rule 11.9 section IV part C

Schedule 8.1

cls 8.29 and 8.33

Approval of equivalence arrangement or grant of dispensation

1 Contents of this Schedule

This Schedule sets out the process for an **asset owner** who wishes to apply for—

- (a) approval of an **equivalence arrangement**; or
- (b) the grant of a **dispensation**.

Compare: Electricity Governance Rules 2003 clause 1 schedule C1 part C

2 Application and supporting information

Each application for an **equivalence arrangement** or a **dispensation** must—

- (a) be in writing; and
- (b) specify the **AOPO** or **technical code** from which approval for an **equivalence arrangement** or the grant of **dispensation** is sought; and
- (c) provide supporting information for the application, including sufficient information about the actual capability of the **asset** or configuration of **assets**; and
- (d) describe any remedial action planned to return the **asset** or configuration of **assets** to a compliant state; and
- (e) specify the required term of the **equivalence arrangement** or **dispensation**; and
- (f) indicate any information for which confidentiality is sought on the grounds that it would, if disclosed, unreasonably prejudice the commercial position of the person who supplied the information (or of the person who is the subject of that information), or would disclose a trade secret, or on the ground that it is necessary to protect information which is itself subject to an obligation of confidence, and the duration of the requirement for confidentiality.

Compare: Electricity Governance Rules 2003 clause 2 schedule C1 part C

3 System operator obligations on receipt of application

No later than **5 business days** after receiving the application made under clause 2, the **system operator** must—

- (a) record the name of the **asset owner** making the application, the date and the subject matter of the application in the **system operator register**; and
- (b) give written notice to the **Authority** of the application; and
- (c) provide the **asset owner** with an estimate of the likely time that it will take to consider the application and the likely costs associated with processing the application.

Compare: Electricity Governance Rules 2003 clause 3 schedule C1 part C

Clause 3: amended, on 20 December 2021, by clause 12 of the Electricity Industry Participation Code Amendment (Code Review Programme) 2019.

Clause 3(b): amended, on 5 October 2017, by clause 109 of the Electricity Industry Participation Code Amendment (Code Review Programme) 2017.

4 Rights and obligations while processing applications

- (1) The **system operator** must use reasonable endeavours to process an application for approval of an **equivalence arrangement** or grant of a **dispensation** within the

- timeframe and costs estimated in accordance with clause 3(c).
- (2) If the **system operator** cannot process the application within the timeframe or costs originally estimated, it must give notice of this fact and its amended estimates of timeframe or costs to the **asset owner**, and clause 5 applies in respect of those costs.
 - (3) The **system operator** may require the provision of additional information at any stage during the application process and, provided the **system operator's** requirements are reasonable, that information must be provided by the **asset owner** if the application is to be processed.
 - (4) The **asset owner** may withdraw an application at any time, provided that it meets all costs incurred by the **system operator** as at the date of the withdrawal of the application. If any costs have been paid in advance, those monies outstanding to the credit of the **asset owner** must immediately be returned to the **asset owner**.
 - (5) An applicant may amend an application being considered by the **system operator** at any time. All amendments must be in writing and submitted to the **system operator** and take effect from the date of receipt.

Compare: Electricity Governance Rules 2003 clause 4 schedule C1 part C

5 **Obligation of asset owner to pay costs**

- (1) The **system operator** and the **asset owner** must agree on the costs involved in processing an application for approval of an **equivalence arrangement** or grant of a **dispensation** and the method for payment to the **system operator** by the **asset owner** of those costs—
 - (a) before the **system operator** proceeds with the application; and
 - (b) at any time during the processing of the application when either—
 - (i) the **system operator** gives written notice to the **asset owner** that it considers the estimate of the likely timeframe involved in processing the application will exceed the estimate given under clause 3(c) or any revised estimate given under clause 4; or
 - (ii) an **asset owner** varies its application and the **system operator**, acting reasonably, considers this variation will change the cost of processing the application.
- (2) The **system operator** is entitled not to proceed until agreement on costs is reached at any of these stages.

Compare: Electricity Governance Rules 2003 clause 5 schedule C1 part C

Clause 5(1)(b)(i): amended, on 5 October 2017, by clause 110 of the Electricity Industry Participation Code Amendment (Code Review Programme) 2017.

6 **Special provisions relating to the grant of dispensations**

- (1) Before granting a **dispensation**, the **system operator** must issue a draft decision on the application. The draft decision must be published on the **system operator register** and must include—
 - (a) an assessment by the **system operator** of the technical issues; and
 - (b) advice from the **system operator** about any changes required to **ancillary services** procurement as a result of the proposed **dispensation**.
- (2) If changes are required to the **procurement plan**, the draft decision must be conditional

on the **procurement plan** being amended appropriately in accordance with clauses 7.13 to 7.22.

- (3) A **participant** may make a submission to the **system operator** on the application that resulted in the publication of the draft decision no later than 10 **business days** after the draft decision is recorded on the **system operator register**.
- (4) The **system operator** must—
 - (a) consider all submissions; and
 - (b) give written notice of its decision on an application to the **participant** who made the application.

Compare: Electricity Governance Rules 2003 clause 6 schedule C1 part C

Clause 6(2): amended, on 1 August 2023, by clause 28 of the Electricity Industry Participation Code Amendment (System Operation Documents) 2023.

Clause 6(4): replaced, on 5 October 2017, by clause 111 of the Electricity Industry Participation Code Amendment (Code Review Programme) 2017.

Clause 6(2): amended, on 1 March 2024, by clause 29 of the Electricity Industry Participation Code Amendment (Code Review Programme) 2024.

7 Decision of the system operator

The **system operator** must advise all applicants for approval of an **equivalence arrangement** or grant of a **dispensation** of—

- (a) its decision as soon as it is made in writing; and
- (b) the reason for its decision.

Compare: Electricity Governance Rules 2003 clause 7 schedule C1 part C

8 Decisions must be recorded

- (1) An approval of an **equivalence arrangement** or grant of a **dispensation** by the **system operator** must be recorded in the **system operator register**.
- (2) The approval must state the name of the **asset owner**, the date, duration and nature of the **equivalence arrangement** or **dispensation**, including any conditions.
- (3) On request, and at the cost of the person making the request, the **system operator** must supply all background information in relation to its decision to that person, other than information designated as commercially sensitive by the relevant **asset owner**.

Compare: Electricity Governance Rules 2003 clause 8 schedule C1 part C

Schedule 8.2

cls 8.48 and 8.50

Approval of alternative ancillary service arrangement

1 Process for approval of alternative ancillary service arrangement

- (1) An application for an **alternative ancillary service arrangement** must—
 - (a) be in writing; and
 - (b) specify the **ancillary service** for which approval for an **alternative ancillary service arrangement** is sought; and
 - (c) provide supporting information for the application, including sufficient information about the actual capability of the **asset** or configuration of **assets**; and
 - (d) describe any remedial action planned to return the **asset** or configuration of **assets** to a compliant state; and
 - (e) specify the required term of the **alternative ancillary service arrangement**; and
 - (f) indicate any information for which confidentiality is sought on the grounds that it would, if disclosed, unreasonably prejudice the commercial position of the person who supplied the information (or the person who is the subject of that information), or would disclose a trade secret, or on the ground that it is necessary to protect information which is itself subject to an obligation of confidence.
- (2) No later than 5 **business days** after receiving the application under subclause (1), the **system operator** must—
 - (a) record the name of the **asset owner** making the application, the date and the subject matter of the application in the **system operator register**; and
 - (b) give written notice to the **Authority** of the application; and
 - (c) provide the **asset owner** with an estimate of the likely time it will take to consider the application and the likely costs associated with processing the application.
- (3) The **system operator** and the **asset owner** must agree on the costs involved in processing an application for authorisation of an **alternative ancillary service arrangement** and the method for payment to the **system operator** by the **asset owner** of those costs—
 - (a) before the **system operator** proceeds with the application; and
 - (b) at any time during the processing of the application, the **system operator** is entitled not to proceed until agreement is reached if either—
 - (i) the **system operator** gives written notice to the **asset owner** that it considers the estimate of the likely timeframe and costs involved in processing the application will exceed the estimate given under subclause (2)(c); or
 - (ii) an **asset owner** varies its application and the **system operator**, acting reasonably, considers this variation will change the costs in processing the application.

Compare: Electricity Governance Rules 2003 clauses 1.1 to 1.3 schedule C2 part C

Clause 1(2): amended, on 20 December 2021, by clause 13 of the Electricity Industry Participation Code Amendment (Code Review Programme) 2019.

Clause 1(2)(b) and (3)(b)(i): amended, on 5 October 2017, by clause 112(1) and (2) of the Electricity Industry Participation Code Amendment (Code Review Programme) 2017.

2 Obligations in processing applications

- (1) The **system operator** must use reasonable endeavours to process an application for authorisation of an **alternative ancillary service arrangement** within the timeframe and costs estimated in accordance with clause 1(2)(c).
- (2) If the **system operator** cannot process an application within the timeframe and costs originally estimated, it must give notice of this fact and its amended estimates of timeframe and costs to the **asset owner** and the provisions of clause 1(3) must apply in respect of those costs.
- (3) The **system operator** may require the provision of additional information at any stage during the application process and, provided the **system operator's** requirements are reasonable, that information must be provided by the **asset owner** if the application is to be processed.
- (4) The **asset owner** may withdraw an application at any time provided that it meets all costs incurred by the **system operator** as at the date of withdrawal of the application. If those costs have been paid in advance, those monies outstanding to the credit of the **asset owner** must immediately be returned to the **asset owner**.
- (5) An applicant may amend an application being considered by the **system operator** at any time. All amendments must be in writing and submitted to the **system operator** and must take effect from the date of receipt.

Compare: Electricity Governance Rules 2003 clause 1.4 schedule C2 part C

3 Decision of the system operator

The **system operator** must advise all applicants for authorisation of an **alternative ancillary service arrangement** of its decision as soon as it is made in writing, and advise such applicants of the reason for that decision.

Compare: Electricity Governance Rules 2003 clause 1.5 schedule C2 part C

4 Decisions must be recorded

An authorisation of an **alternative ancillary service arrangement** by the **system operator** must be recorded in the **system operator register**. Except for information that the **system operator** agreed was commercially sensitive, the authorisation must state the name of the **asset owner**, the date, duration and nature of the **alternative ancillary service arrangement**, including any conditions. On request, and at the cost of the person making the request, the **system operator** must supply all background information in relation to its decision to that person, other than information designated as commercially sensitive by the relevant **asset owner**.

Compare: Electricity Governance Rules 2003 clause 1.6 schedule C2 part C

Schedule 8.3 Technical codes

cl 1.1

Technical Code A – Assets

1 Purpose

The purpose of this **technical code** is to define obligations for **asset owners** and technical standards for **assets** that are supportive of, or more detailed than, those set out in subpart 2 of Part 8, in order to enable the **system operator** to plan to comply, and to comply, with the **principal performance obligations**.

Compare: Electricity Governance Rules 2003 clause 1 technical code A schedule C3 part C

2 General requirements

- (1) Each **asset owner** must ensure that—
 - (a) its **assets** at **grid exit points** and at **grid injection points**, and, in the case of **connected asset owners**, the **assets** of any **embedded generator** connected to it, are identified and referred to by a **system number**; and
 - (b) its **assets**, both in the manner in which they are designed and operated, are capable of being operated, and operate, within the limits stated in the **asset capability statement** provided by the **asset owner** for that **asset**; and
 - (c) it meets any other reasonable requirements of the **system operator**, identified during planning studies, which are required for the **system operator** to plan to comply, or to comply, with its **principal performance obligations**.
- (2) Each **asset owner** must provide the **system operator** with an **asset capability statement**, and any other information reasonably required by the **system operator**, to allow the **system operator** to assess compliance of its **asset** or any configuration of **assets** with the requirements of the **asset owner performance obligations** and **technical codes** at each of the following times:
 - (a) before the completion of planning for the construction of that **asset** or configuration of **assets**;
 - (b) at, or before, the completion of construction but before the **commissioning** of that **asset** or configuration of **assets**, except that the **asset owner** must put in place a **commissioning** plan in accordance with subclauses (6) to (8) to minimise the impact of **commissioning** tests on the **system operator's** ability to comply with its **principal performance obligations**, and adhere to this plan during **commissioning**, unless otherwise agreed to by the **system operator**.
- (3) On, or before, completion of **commissioning** of an **asset** or configuration of **assets**, the **asset owner** must obtain a final assessment in writing from the **system operator** that the **asset** or configuration of **assets** meets the requirements of the **asset owner performance obligations** and **technical codes**. This final assessment must be based on the information supplied by the **asset owner** and, if necessary, the result of **system tests** at **commissioning**.
- (4) The **system operator** must give the assessment referred to in subclause (2)(b) within a

- reasonable time frame of the request and supply the **asset owner** with all information that supports its assessment. Any permission granted by the **system operator** to an **asset owner** to conduct **commissioning** of any **asset** or configuration of **assets** must permit connection of the **asset** (or configuration of **assets**) solely for the purposes of **commissioning**.
- (5) Each **asset owner** must provide the **system operator** with an **asset capability statement** in the form from time to time **published** by the **system operator** for each **asset** that is proposed to be connected, or is connected to, or forms part of the **grid**. The **asset capability statement** must—
- (a) include all information reasonably requested by the **system operator** so as to allow the **system operator** to determine the limitations in the operation of the **asset** that the **system operator** needs to know for the safe and efficient operation of the **grid**; and
 - (b) include any modelling data for the planning studies, as reasonably requested by the **system operator**; and
 - (c) be updated and reissued to the **system operator** as information and design development progresses through the study, design, manufacture, testing and **commissioning** phases; and
 - (d) be complete and up to date before the **commissioning** of the **asset**; and
 - (e) be complete and up to date at all times while the **asset** is connected to, or forms part of, the **grid**.
- (6) Each **asset owner** must provide a **commissioning** plan or test plan in accordance with subclauses (7) or (8) (as the case may be) in the following situations:
- (a) when changes are made to **assets** that alter any of the following at the **grid interface**:
 - (i) the **single-line diagram**;
 - (ii) a protection system, other than a change to a protection system setting;
 - (iii) a **control system**, including a change to a **control system** setting;
 - (iv) any rating of **assets**;
 - (b) when **assets** are to be connected to, or are to form part of, the **grid**;
 - (c) if it is necessary for an **asset owner** to perform a **system test** or other test to ascertain or confirm **asset** capabilities, and if the **commissioning** or testing or connection of those **assets** may affect the **system operator**'s ability to plan to comply, or to comply with, its **principal performance obligations**. If an **asset owner** is unsure whether the **commissioning** or connection of an **asset** may impact on the **system operator**'s ability to plan to comply, and to comply, with the **principal performance obligations** it must contact the **system operator** for advice.
- (7) The **commissioning** plan prepared by an **asset owner** and agreed by the **system operator** must—
- (a) include a timetable containing the sequence of events necessary to connect the **assets** to the **grid** and conduct any proposed **system test**; and
 - (b) contain the protection and control settings to be applied before the **assets** are made live (where live has the meaning given to it in the Electricity (Safety)

- Regulations 2010); and
- (c) contain the procedures for **commissioning** the plant with minimum risk to personnel and plant and to the ability of the **system operator** to plan to comply and to comply with its **principal performance obligations**.
 - (8) If a test plan is required under subclause (6), it must be prepared by the **asset owner** in consultation with the **system operator**. The test plan must contain sufficient information to enable the **system operator** to plan to comply, and to comply, with the **principal performance obligations**.
 - (9) Once assessed by the **system operator** acting reasonably, the **asset owner** must follow the **commissioning** plan or test plan at all times, unless otherwise agreed with the **system operator** (such agreement must not be unreasonably withheld if compliance with the **commissioning** plan or testing plan is not practicable and non-compliance does not impact on the **system operator's** ability to comply with its **principal performance obligations** or on other **asset owners**).

Compare: Electricity Governance Rules 2003 clause 2 technical code A schedule C3 part C

Clause 2(1)(a): amended, on 1 February 2016, by clause 17 of the Electricity Industry Participation Code Amendment (Code Review Programme) 2015.

Clause 2(1)(a): amended, on 20 December 2021, by clause 14 of the Electricity Industry Participation Code Amendment (Code Review Programme) 2019.

Clause 2(1) and (4) – (7): amended, on 23 February 2015, by clause 75 of the Electricity Industry Participation Code Amendment (Distributed Generation) 2014.

Clause 2(1) - (7) and (9): amended, on 5 October 2017, by clause 113 of the Electricity Industry Participation Code Amendment (Code Review Programme) 2017.

3 Requirements for asset information

- (1) In accordance with clause 8.25(4), the following information is required by the **system operator** to assist it to plan to comply, and to comply, with its **principal performance obligations**:
 - (a) sufficient information must be exchanged between the **system operator** and the **asset owner** to ensure that both fully understand the implications of any changes to the **asset capability statement** or of any proposed connection of the relevant **assets** to the **grid** or to the **local network**. This information must be exchanged in accordance with a timetable agreed to by the **system operator** and the **asset owner**:
 - (b) if reasonably requested by the **system operator**, the **asset owner** must provide sufficient information to the **system operator** to demonstrate the compliance of the **asset owner's assets** with the **asset owner performance obligations** and the **technical codes**.
- (2) Information about an **asset, supply** or **demand** of other **asset owners** must only be disclosed by the **system operator**—
 - (a) as expressly provided for in this Code; or
 - (b) as reasonably required in a **grid emergency** or to ensure the security of the **grid**;
or
 - (c) as required by law; or
 - (d) otherwise as may be agreed with the relevant **asset owners**.
- (3) Each **asset owner** must provide the **system operator** with—
 - (a) all information reasonably requested by the **system operator** so as to ensure

compliance with clause 8.25(4) and to enable the **system operator** to assess the **grid interface**; and

- (b) details of protection systems, including settings, to ensure that the requirements of clause 8.25(4) are met.
- (4) Each **asset owner** must ensure that all supporting information for the operational control of **assets** is kept up to date.

Compare: Electricity Governance Rules 2003 clause 3 technical code A schedule C3 part C

Clause 3(1)(a): amended, on 23 February 2015, by clause 75 of the Electricity Industry Participation Code Amendment (Distributed Generation) 2014.

Clause 3(1)(a): amended, on 5 October 2017, by clause 114 of the Electricity Industry Participation Code Amendment (Code Review Programme) 2017.

Clause 3(2): amended, on 20 December 2021, by clause 15(a) of the Electricity Industry Participation Code Amendment (Code Review Programme) 2019.

Clause 3(2)(cc): amended, on 20 December 2021, by clause 15(b) of the Electricity Industry Participation Code Amendment (Code Review Programme) 2019.

4 Requirements for grid and grid interface

- (1) Each **asset owner** and **grid owner** must co-operate with the **system operator** to ensure that protection systems on both sides of a **grid interface**, which include **main protection systems** and **back up protection systems**, are co-ordinated so that a faulted **asset** is **electrically disconnected** by the **main protection system** first and the other **assets** are not prematurely **electrically disconnected**.
- (2) A proposed **grid interface**, including the settings of any associated protection system, must be agreed between the relevant **asset owner** and the **system operator** before being implemented.
- (3) Each **asset owner** must ensure that sufficient **circuit breakers** are provided for its **assets** so that each of its **assets** is able to be **electrically disconnected** from the **grid** whenever a fault occurs within the **asset**.
- (4) Each **asset owner** must ensure that it provides protection systems for its **assets** that are connected to, or form part of, the **grid**. Each **asset owner** must also ensure that as a minimum requirement—
- (a) such protection systems support the **system operator** in planning to comply, and complying, with the **principal performance obligations** and are designed, **commissioned** and maintained, and settings are applied, to achieve the following performance in a reliable manner:
- (i) **electrically disconnect** any faulted **asset** in minimum practical time (taking into account selectivity margins and industry best design practice) and minimum disruption to the operation of the **grid** or other **assets**:
- (ii) be selective when operating, so that the minimum amount of **assets** are **electrically disconnected**:
- (iii) as far as reasonably practicable, preserve power system stability; and
- (b) it provides duplicated **main protection systems** for each of its **assets** at voltages of 220 kV a.c. or above, other than busbars; and
- (c) it provides, for each of its 220 kV a.c. busbars—
- (i) a single **main protection system** and a **back up protection system**; or
- (ii) if the performance of its **back up protection system** does not meet the requirements of paragraph (a), a duplicated **main protection system**; and

- (d) it provides duplicated **main protection systems** for each of its busbars at voltages above 220 kV a.c; and
 - (e) it designs, tests and maintains its **main protection systems** at voltages of 220 kV a.c. or above in accordance with the requirements set out in Appendix A; and
 - (f) it provides a **circuit breaker failure protection system**, that need not be duplicated, for each **circuit breaker** at voltages of 220 kV a.c. or above. **Circuit breaker** duplication is not required; and
 - (g) protection system design for a connection of **assets** to the **grid** at lower voltages must be similar to existing design practice in adjacent connections of **assets** to ensure coordination of protection systems.
- (5) At a **point of connection**—
- (a) an **asset owner**, other than a **grid owner**, must provide a means of checking **synchronisation** before the switching of **assets** if it is possible that such switching may result in **electrical connection** of parts of the New Zealand electric power system that are not **synchronised**; and
 - (b) a **grid owner** must provide a means of checking **synchronisation** before the switching of **assets** in locations agreed with the **system operator** so that it is not possible for such switching to result in **electrical connection** of parts of the New Zealand electric power system that are not **synchronised**.
- (6) An auto-reclose facility at the **grid interface**, at which power flows into the **grid** can occur, must include an appropriate **synchronising** check facility.

Compare: Electricity Governance Rules 2003 clause 4 technical code A schedule C3 part C

Clause 4 Heading: amended, on 15 May 2014, by clause 11 of the Electricity Industry Participation (Minor Code Amendments) Code Amendment 2014.

Clause 4(1), (3), (4) and (5): amended, on 5 October 2017, by clause 115 of the Electricity Industry Participation Code Amendment (Code Review Programme) 2017.

Clause 4(4) and (5): amended, on 23 February 2015, by clause 75 of the Electricity Industry Participation Code Amendment (Distributed Generation) 2014.

5 Specific requirements for generators

- (1) Each **generator** must ensure that—
- (a) each of its **generating units**, and its associated **control systems**,—
 - (i) supports the **system operator** to plan to comply, and to comply, with the **principal performance obligations**; and
 - (ii) is able to **synchronise** at a stable frequency within the frequency range stated in the **asset capability statement** for that **asset**; and
 - (b) the rate of change in the output of any of its **generating units** does not adversely affect the **system operator's** ability to plan to comply, and to comply, with the **principal performance obligations**. The rate of change must be adjustable to allow for changes in **grid** conditions; and
 - (c) each of its **generating units** has a speed governor that—
 - (i) provides stable performance with adequate damping; and
 - (ii) has an adjustable droop over the range of 1% to 7%; and
 - (iii) does not adversely affect the operation of the **grid** because of any of its non-linear characteristics; and
 - (d) appropriate speed governor settings to be applied before commencing **system**

- tests for a **generating unit** are agreed between the **system operator** and the **generator**. The performance of the **generating unit** is then assessed by measurements from **system tests** and final settings are then applied to the **generating unit** before making it ready for service after those final settings are agreed between the **system operator** and the **generator**. An **asset owner** must not change speed governor settings without **system operator** approval.
- (2) Each **generator** must ensure that each of its **generating units** connected to the **grid** is equipped with—
- (a) an excitation and voltage control system with a voltage set point that is adjustable over the range of voltage set out in clause 8.23 and operates continuously in the voltage control mode when **synchronised**; and
 - (b) in order to meet the **asset owner performance obligations**, either—
 - (i) a connection transformer with an appropriate range of taps on each transformer together with an on-load tap-changer; or
 - (ii) **assets** to give a dynamic performance equivalent to those required by subparagraph (i).
- (3) If the output of more than 1 **generating unit** is controlled by a common **control system**, the **generator** must ensure that—
- (a) the common **control system** does not adversely affect the ability of the **system operator** to plan to comply, and to comply, with the **principal performance obligations**; and
 - (b) the combined output from the **generating units** performs as though it were from 1 **generating unit**; and
 - (c) the **control system** does not degrade the individual performance of any one **generating unit**.
- (4) Each **generator** and **grid owner** must ensure that each of its **assets** is capable of operating under the voltage imbalance conditions stated in clause 4.9 of the **Connection Code** and, when operated within the limits stated in its **asset capability statement**, does not—
- (a) contribute unbalanced phase currents into the **grid**; or
 - (b) aggravate any current imbalance that may occur on the **grid**.
- (5) At some **points of connection**, a **generator** must ensure that its **generating units** have both **main protection systems** and **back-up protection systems** for nearby faults on the **grid**, if the necessity for, and the method of providing, such protection systems is agreed between the **system operator** and the **generator**.

Compare: Electricity Governance Rules 2003 clause 5 technical code A schedule C3 part C

Clause 5(2): amended, on 23 February 2015, by clause 75 of the Electricity Industry Participation Code Amendment (Distributed Generation) 2014.

Clause 5(2): amended, on 5 October 2017, by clause 116 of the Electricity Industry Participation Code Amendment (Code Review Programme) 2017.

Clause 5(2): amended, on 20 December 2021, by clause 16 of the Electricity Industry Participation Code Amendment (Code Review Programme) 2019.

Clause 5(4): amended, on 19 May 2016, by clause 29 of the Electricity Industry Participation Code Amendment (System Operator and Alignment with Statutory Objective) 2016.

Clause 5(1)(c)(ii): amended, on 1 March 2024, by clause 30 of the Electricity Industry Participation Code Amendment (Code Review Programme) 2024.

6 Specific requirements for connected asset owners

Each **connected asset owner** must agree with the **system operator** any temporary or permanent connection of the **connected asset owner's assets** if those **assets** become simultaneously connected to the **grid** at more than 1 **point of connection**.

Compare: Electricity Governance Rules 2003 clause 6 technical code A schedule C3 part C

Clause 6 Heading: amended, on 1 February 2016, by clause 18(1) of the Electricity Industry Participation Code Amendment (Code Review Programme) 2015.

Clause 6: amended, on 23 February 2015, by clause 75 of the Electricity Industry Participation Code Amendment (Distributed Generation) 2014.

Clause 6: amended, on 1 February 2016, by clause 18(2) of the Electricity Industry Participation Code Amendment (Code Review Programme) 2015.

Clause 6: amended, on 5 October 2017, by clause 117 of the Electricity Industry Participation Code Amendment (Code Review Programme) 2017.

7 Modifications and changes to assets

(1) **Assets** that have been modified, or are proposed to be modified, are deemed to be new **assets** for the purposes of this Code and this **Technical Code** and are subject to the requirements for connection to the **grid** and the requirements for **commissioning assets**. For the purposes of this Schedule, the following are considered to be modifications to **assets**, if the new connection or alteration may affect the capacity of the **assets** or may affect **asset owner performance obligations** or **technical code** requirements:

- (a) a new connection of **assets** to the **grid** or a **local network**;
- (b) a new connection of **assets** to form part of the **grid**;
- (c) a new connection of an **embedded generator** to a **local network** other than an **excluded generator** as defined in clause 8.21(1);
- (d) an alteration to **assets** already connected to the **grid** or, in the case of **embedded generator**, already connected to a **local network**.

(2) The **asset owner** must give written notice to the **system operator** in a timely manner of any **assets** that have been **decommissioned** if the **assets** affect or could affect the **system operator's** ability to comply with its **principal performance obligations**.

Compare: Electricity Governance Rules 2003 clause 7 technical code A schedule C3 part C

Clause 7(1): amended, on 23 February 2015, by clause 75 of the Electricity Industry Participation Code Amendment (Distributed Generation) 2014.

Clause 7(1) and (2): amended, on 5 October 2017, by clause 118 of the Electricity Industry Participation Code Amendment (Code Review Programme) 2017.

8 Records, tests and inspections

(1) Each **asset owner** must arrange for, and retain, records for each of its **assets** to demonstrate that the **assets** comply with the **asset owner performance obligations** and this **technical code**.

(2) In addition to the requirements for **commissioning** or testing in clause 2(6) to (8), each **asset owner** must carry out periodic testing—

- (a) of its **assets**, including **automatic under-frequency load shedding** systems, in accordance with Appendix B
- (b) *[Revoked]*.

(3) If the **system operator** advises an **asset owner** that it reasonably believes that an **asset** may not comply with an **asset owner performance obligation** or this **technical code**, the **asset owner** must—

- (a) as soon as practicable, but no later than 30 days after receiving a written request, advise the **system operator** of its remedial or test plan for the **assets**; and
 - (b) as soon as reasonably practicable undertake any remedial action or testing of its **assets** in accordance with its plan advised to the **system operator** in paragraph (a). The **system operator** may require such testing or remedial action to be undertaken in the presence of a **system operator** representative.
- (4) Each **asset owner** must, at the request of the **system operator**, provide access to records of the performance or testing of an **asset** and access to inspect an **asset**.

Compare: Electricity Governance Rules 2003 clause 8 technical code A schedule C3 part C

Clause 8(2): substituted, on 7 August 2014, by clause 16 of the Electricity Industry Participation Code Amendment (Extended Reserve) 2014.

Clause 8(2): amended, on 5 October 2017, by clause 119 of the Electricity Industry Participation Code Amendment (Code Review Programme) 2017.

Clause 8.2(a): amended, on 21 December 2021, by clause 19(1) of the Electricity Industry Participation Code Amendment (Automatic Under-Frequency Load Shedding Systems) 2021.

Clause 8.2(b): revoked, on 21 December 2021, by clause 19(2) of the Electricity Industry Participation Code Amendment (Automatic Under-Frequency Load Shedding Systems) 2021.

9 Status of system operator approval

A review and approval by the **system operator** under this Code must not be construed as confirming or endorsing the design or warranting the safety, durability or reliability of an **asset**. Such review or approval does not relieve the **asset owner** from its obligations to continue to meet the requirements of this Code. The **system operator** is not, by reason of any such review or lack of review, responsible for strength, adequacy of design or capacity of an **asset**. In undertaking a review, the **system operator** is not responsible for any consequence of a failure of an **asset** due to inadequate design.

Compare: Electricity Governance Rules 2003 clause 9 technical code A schedule C3 part C

Appendix A: Main protection system requirements

1 General requirements

An **asset owner** must design, test and maintain all **main protection systems** at voltages of 220 kV a.c. or above to conform to electricity industry standards and practices as they are reasonably and ordinarily applied by a skilled and experienced **asset owner** to current installations at voltages of 220 kV a.c. or above in the New Zealand context.

Compare: Electricity Governance Rules 2003 clause 1 appendix A technical code A schedule C3 part C

2 Specific requirements for main protection systems

Main protection systems at voltages of 220 kV a.c. or above must meet the requirements set out below:

- (a) either test blocks or both test switches and test terminals must be provided:
- (b) the electrical continuity of fused protection circuits, including d.c. and voltage transformer circuits must be supervised:
- (c) the electrical continuity of **circuit breaker** trip circuits must be supervised.

Compare: Electricity Governance Rules 2003 clause 2 appendix A technical code A schedule C3 part C

3 Specific requirements for duplicated main protection systems

Duplicated **main protection systems** (the 2 components of which are referred to in this appendix as main 1 protection and main 2 protection) at voltages of 220 kV a.c. or above must meet the requirements set out below:

- (a) duplicated **main protection systems** must be designed with sufficient coverage and probability of detection that if any or all parts of 1 **main protection system** fail, the other **main protection system electrically disconnects** a faulted **asset** before a **back up protection system** initiates the **electrical disconnection** of other non-faulted **assets**:
- (b) the d.c. supply to duplicated **main protection systems** must consist of 2 independent station batteries, each with its own charger, supervision, and with a capacity and carry over duty to cover charger failure until repair and restoration. Station batteries may only feed a common primary d.c. busbar provided that the busbar is insulated and isolated from earth:
- (c) the d.c. supply to each duplicated **main protection system** must be independently fused at the primary d.c. busbar:
- (d) the manufacturer of main 1 protection must not be the same as the manufacturer of main 2 protection, unless one protection uses different measurement principles from the other:
- (e) the current transformer core (or an equivalent instrument) and the cabling associated with that current transformer core or equivalent instrument (as the case may be) used for main 1 protection must be independent from that used for main 2 protection:
- (f) if a voltage transformer supply is required for main 1 or main 2 protection—
 - (i) the supply must be fused at the voltage transformer; and
 - (ii) the supply for main 1 protection must use an independent fuse and cable

from those used for main 2 protection:

- (g) main 1 protection must use, in each of the **circuit breakers** tripped by that main 1 protection, an independent trip coil from that used for main 2 protection:
- (h) if protection signalling is used, main 1 protection must use a signal channel over an independent bearer on a different route from that used for main 2 protection:
- (i) main 1 protection cabling must be segregated from main 2 protection cabling in a manner that minimises the risk of common mode failure of main 1 and 2 protection and minimises the number of connections in any protection circuit.

Compare: Electricity Governance Rules 2003 clause 3 appendix A technical code A schedule C3 part C
Clause 3(a) and (i): amended, on 5 October 2017, by clause 120 of the Electricity Industry Participation Code Amendment (Code Review Programme) 2017.
Clause 3(i): amended, on 23 February 2015, by clause 75 of the Electricity Industry Participation Code Amendment (Distributed Generation) 2014.

4 Existing equipment

Despite clauses 1 and 3—

- (a) a current transformer **commissioned** before 31 May 2007 is not required to comply with clause 3(e) until the current transformer is replaced; and
- (b) a **circuit breaker commissioned** before 31 May 2007, if not designed to incorporate a second trip coil, is not required to comply with clause 3(g) until the **circuit breaker** is replaced; and
- (c) cabling **commissioned** before 31 May 2007, if not designed to be segregated, is not required to comply with the segregation requirements of clause 3(i) until the cabling is replaced.

Compare: Electricity Governance Rules 2003 clause 4 appendix A technical code A schedule C3 part C
Clause 4: amended, on 5 October 2017, by clause 121 of the Electricity Industry Participation Code Amendment (Code Review Programme) 2017.

Appendix B: Routine testing of assets and automatic under-frequency load shedding systems

Cross heading: amended, on 7 August 2014, by clause 17 of the Electricity Industry Participation Code Amendment (Extended Reserve) 2014.

Cross heading: amended, on 21 December 2021, by clause 20 of the Electricity Industry Participation Code Amendment (Automatic Under-Frequency Load Shedding Systems) 2021.

1 Periodic tests to be carried out

- (1) This Appendix sets out periodic tests required for the purposes of clause 8(2) of **Technical Code A**.
- (2) Each **asset owner** may be legally required, other than under this Code, to carry out additional tests to ensure that their **assets**, including **automatic under-frequency load shedding** systems, are safe and reliable.
- (3) For the purposes of this Appendix, **generating unit** does not include a **generating unit** for which wind is the primary power source.

Compare: Electricity Governance Rules 2003 clause 1 appendix B technical code A schedule C3 part C

Clause 1: substituted, on 7 August 2014, by clause 18 of the Electricity Industry Participation Code Amendment (Extended Reserve) 2014.

Clause 1(2): amended, on 21 December 2021, by clause 21 of the Electricity Industry Participation Code Amendment (Automatic Under-Frequency Load Shedding Systems) 2021.

2 Generating unit frequency response

Each **generator**, other than **generators** who are owners of **excluded generating stations** that are not subject to a directive issued by the **Authority** under clause 8.38, must—

- (a) test the trip frequencies and trip time delays of each of its **generating units'** analogue over-frequency relays and analogue under-frequency relays at least once every 4 years; and
- (b) test the trip frequencies and trip time delays of each of its **generating units'** non-self monitoring digital over-frequency relays and non-self monitoring digital under-frequency relays at least once every 4 years; and
- (c) test the trip frequencies and trip time delays of each of its **generating units'** self monitoring digital over-frequency relays and self monitoring digital under-frequency relays at least once every 10 years; and
- (d) based on the tests carried out in accordance with paragraphs (a) to (c), provide a verified set of under-frequency trip settings and time delays to the **system operator** in an updated **asset capability statement** within 3 months of the completion date of each such test; and
- (e) based on the tests carried out in accordance with paragraphs (a) to (c), provide a verified set of over-frequency trip settings and time delays to the **system operator** in an updated **asset capability statement** within 3 months of the completion date of each such test.

Compare: Electricity Governance Rules 2003 clause 2 appendix B technical code A schedule C3 part C

3 Generating unit governor and speed control

Each **generator**, other than **generators** who are owners of **excluded generating stations** that are not subject to a directive issued by the **Authority** under clause 8.38 must—

- (a) test the governor system response of each of its **generating units**' mechanical or analogue speed governors at least once every 5 years; and
- (b) test the governor system response of each of its **generating units**' digital or electro-hydraulic speed governors at least once every 10 years; and
- (c) based on the tests carried out in accordance with paragraphs (a) or (b), provide a verified set of modelling parameters and governor system response data to the **system operator** in an updated **asset capability statement** within 3 months of the completion date of each such test, including—
 - (i) a block diagram showing the mathematical representation of the governor; and
 - (ii) a block diagram showing the mathematical representation of the turbine dynamics including non-linearity and the applicable fuel source; and
 - (iii) a parameter list showing gains, time constants and other settings applicable to the block diagrams.

Compare: Electricity Governance Rules 2003 clause 3 appendix B technical code A schedule C3 part C

4 **Generating unit transformer voltage control**

Each **generator** with a **point of connection** to the **grid** must—

- (a) test the operation of each of its **generating unit** transformers' on-load tap changer analogue **control systems** at least once every 4 years; and
- (b) test the operation of each of its **generating unit** transformers' on-load tap changer digital **control systems** at least once every 10 years; and
- (c) based on the tests carried out in accordance with paragraphs (a) or (b), provide a verified set of control parameters including voltage set points, operating dead bands and response times to the **system operator** in an updated **asset capability statement** within 3 months of the completion date of each such test.

Compare: Electricity Governance Rules 2003 clause 4 appendix B technical code A schedule C3 part C

5 **Generating unit voltage response and control**

Each **generator** with a **point of connection** to the **grid** must—

- (a) test the modelling parameters and voltage response of each of its **generating units**' analogue excitation systems at least once every 5 years; and
- (b) test the modelling parameters and voltage response of each of its **generating units**' digital excitation systems at least once every 10 years; and
- (c) based on the tests carried out in accordance with paragraphs (a) or (b), provide a verified set of modelling parameters and voltage response data to the **system operator** in an updated **asset capability statement** within 3 months of the completion date of each such test, including—
 - (i) a block diagram showing the mathematical representation of the automatic voltage regulator; and
 - (ii) a block diagram showing the mathematical representation of the exciter; and
 - (iii) a parameter list showing gains, time constants and other settings applicable to the block diagrams.

Compare: Electricity Governance Rules 2003 clause 5 appendix B technical code A schedule C3 part C

6 North Island connected asset owner automatic under-frequency load shedding systems profiles and trip settings

Each North Island **connected asset owner** must—

- (a) provide the profile information described in clause 7(9) of **Technical Code B** of Schedule 8.3 to the **system operator** in an updated **asset capability statement** at least once every year; and
- (b) test the operation of its analogue **automatic under-frequency load shedding** systems at least once every 4 years; and
- (c) test the operation of its non-self monitoring digital **automatic under-frequency load shedding** systems at least once every 4 years; and
- (d) test the operation of its self monitoring digital **automatic under-frequency load shedding** systems at least once every 10 years; and
- (e) based on the relevant test carried out in accordance with paragraphs (b), (c) or (d), provide a verified set of trip settings and time delays to the **system operator** in an updated **asset capability statement** within 3 months of the completion date of the relevant test.

Compare: Electricity Governance Rules 2003 clause 6 appendix B technical code A schedule C3 part C
Clause 6: revoked, on 7 August 2014, by clause 19 of the Electricity Industry Participation Code Amendment (Extended Reserve) 2014.
Clause 6: replaced, on 21 December 2021, by clause 22 of the Electricity Industry Participation Code Amendment (Automatic Under-Frequency Load Shedding Systems) 2021.

7 South Island grid owner automatic under-frequency load shedding systems profiles and trip settings

Each South Island **grid owner** must—

- (a) provide the profile information described in clause 7(9) of **Technical Code B** of Schedule 8.3 to the **system operator** in an updated **asset capability statement** at least once every year; and
- (b) test the operation of its analogue **automatic under-frequency load shedding** systems at least once every 4 years; and
- (c) test the operation of its non-self monitoring digital **automatic under-frequency load shedding** systems at least once every 4 years; and
- (d) test the operation of its self monitoring digital **automatic under-frequency load shedding** systems at least once every 10 years; and
- (e) based on the relevant test carried out in accordance with paragraphs (b), (c) or (d), provide a verified set of trip settings and time delays to the **system operator** in an updated **asset capability statement** within 3 months of the completion date of the relevant test.

Compare: Electricity Governance Rules 2003 clause 7 appendix B technical code A schedule C3 part C
Clause 7: revoked, on 7 August 2014, by clause 19 of the Electricity Industry Participation Code Amendment (Extended Reserve) 2014.
Clause 7: replaced, on 21 December 2021, by clause 22 of the Electricity Industry Participation Code Amendment (Automatic Under-Frequency Load Shedding Systems) 2021.

8 Grid owner transformer voltage range

Each **grid owner** must—

- (a) test the operation of each of its transformers' on-load tap changer analogue **control systems** at least once every 4 years; and
- (b) test the operation of each of its transformers' on-load tap changer digital **control systems** at least once every 10 years; and
- (c) based on the tests carried out in accordance with paragraphs (a) or (b), provide a verified set of control parameters to the **system operator** in an updated **asset capability statement** within 3 months of the completion date of each such test, including voltage set points, operating dead bands and response times.

Compare: Electricity Governance Rules 2003 clause 8 appendix B technical code A schedule C3 part C

9 Grid owner static var compensator transient response and control

Each **grid owner** must—

- (a) test the transient response, steady state response and a.c. disturbance response of each of its static var compensators at least once every 10 years; and
- (b) test the operation of each of its static var compensators' analogue **control systems** at least once every 4 years; and
- (c) test the operation of each of its static var compensators' digital **control systems** at least once every 10 years; and
- (d) based on the test carried out in accordance with paragraph (a), provide a verified set of modelling parameters, transient response parameters, steady state response parameters, and a.c. disturbance response data to the **system operator** in an updated **asset capability statement** within 3 months of the completion date of each such test including—
 - (i) a block diagram showing the mathematical representation of the static var compensator; and
 - (ii) a parameter list showing gains, time constants, limiters and other settings applicable to the block diagrams; and
 - (iii) a detailed functional description of all of the components of the static var compensator and how they interact in each mode of control; and
 - (iv) step response test results; and
 - (v) a.c. fault recovery disturbance test results; and
- (e) based on tests carried out in accordance with paragraphs (b) or (c), provide a set of **control system** test results to the **system operator** in an updated **asset capability statement** within 3 months of the completion date of each such test.

Compare: Electricity Governance Rules 2003 clause 9 appendix B technical code A schedule C3 part C

10 Grid owner capacitors and reactive power control systems

Each **grid owner** must—

- (a) test the capacitance of each of its capacitors at least once every 8 years; and
- (b) test the operation of each of its reactive power control assets' analogue **control systems** at least once every 4 years; and
- (c) test the operation of each of its reactive power control assets' digital **control systems** at least once every 10 years; and
- (d) based on the test carried out in accordance with paragraph (a), provide a set of test

results to the **system operator** in an updated **asset capability statement** within 3 months of the completion date of each such test; and

- (e) based on tests carried out in accordance with paragraphs (b) or (c), provide a verified set of **control system** test results including voltage set points, operating dead bands and time delays to the **system operator** in an updated **asset capability statement** within 3 months of the completion date of each such test.

Compare: Electricity Governance Rules 2003 clause 10 appendix B technical code A schedule C3 part C

11 Grid owner synchronous compensators

Each **grid owner** must—

- (a) test each of its synchronous compensators' analogue and electromechanical excitation systems at least once every 5 years; and
- (b) test each of its synchronous compensators' digital excitation systems at least once every 10 years; and
- (c) based on the tests carried out in accordance with paragraphs (a) or (b), provide a verified set of modelling parameters and voltage response data to the **system operator** in an updated **asset capability statement** within 3 months of the completion date of each such test including—
 - (i) a block diagram showing the mathematical representation of the automatic voltage regulator; and
 - (ii) a block diagram showing the mathematical representation of the exciter; and
 - (iii) a detailed functional description of the excitation system in all modes of control; and
 - (iv) a parameter list showing gains, time constants, limiters and other settings applicable to the block diagrams.

Compare: Electricity Governance Rules 2003 clause 11 appendix B technical code A schedule C3 part C

12 HVDC link frequency control and protection

The **HVDC owner** must—

- (a) test the operation of each of its **HVDC link's** analogue **control systems** at least once every 4 years; and
- (b) test the operation of each of its **HVDC link's** digital **control systems** at least once every 10 years; and
- (c) test the operation of each of its **HVDC link's** analogue protection systems at least once every 4 years; and
- (d) test the operation of each of its **HVDC link's** digital protection systems at least once every 10 years; and
- (e) test the modulation functions on its **HVDC link** at least once every 10 years; and
- (f) based on the tests carried out in accordance with paragraphs (a) or (b), provide a set of **control system** test results and verified modelling parameters to the **system operator** in an updated **asset capability statement** within 3 months of the completion date of each such test; and
- (g) based on the tests carried out in accordance with paragraphs (c) or (d), provide a set of protection system test results to the **system operator** in an updated **asset**

- capability statement** within 3 months of the completion date of each such test; and
- (h) based on the tests carried out in accordance with paragraph (e), provide a set of modulation function test results to the **system operator** in an updated **asset capability statement** within 3 months of the completion date of each such test including—
- (i) a block diagram showing the mathematical representation of the **HVDC link**; and
 - (ii) a parameter list showing gains, time constants, limiters and other settings applicable to the block diagram; and
 - (iii) a detailed functional description of all of the components of the **HVDC link** and how they interact in each mode of control.

Compare: Electricity Governance Rules 2003 clause 12 appendix B technical code A schedule C3 part C

13 Asset owner a.c. protection systems

Each **asset owner** must—

- (a) test the operation of the analogue protection systems on its a.c. **assets** at least once every 4 years; and
- (b) test the operation of the non-self monitoring digital protection systems on its a.c. **assets** at least once every 4 years; and
- (c) test the operation of the self monitoring digital protection systems on its a.c. **assets** at least once every 10 years; and
- (d) test the operation of the protection system measuring circuits on its a.c. **assets** by secondary injection at least once every 4 years; and
- (e) test the operation of the protection system trip circuits, including circuit breaker trips, on its a.c. **assets** at least once every 4 years; and
- (f) confirm at least once every 4 years that its protection settings are identified, coordinated, applied correctly and meet the requirements of the **AOPOs** and the **technical codes**; and
- (g) based on tests carried out in accordance with paragraphs (a) to (e), provide a verification to the **system operator** in an updated **asset capability statement** that the protection systems meet the requirements of the **AOPOs** and **technical codes** within 3 months of the completion date of each such test; and
- (h) based on the confirmation carried out in accordance with paragraph (f), provide an updated **asset capability statement** to the **system operator** within 3 months of the completion date of each such confirmation.

Compare: Electricity Governance Rules 2003 clause 13 appendix B technical code A schedule C3 part C

14 Representative testing

- (1) Subject to clause 8(3) of **Technical Code A**, each **asset owner** may provide the information required under clauses 3(c), 5(c), and 11(c) to the **system operator**, based on representative modelling parameters and response data instead of based on the tests required under clauses 3(a) and (b), 5(a) and (b), and 11(a) and (b), for any group of identical **assets**, if each of those **assets**—

- (a) was manufactured to the same specification; and
 - (b) is installed at the same location; and
 - (c) is controlled in the same way; and
 - (d) has a similar maintenance history.
- (2) Each **asset owner** providing representative modelling parameters and response data to the **system operator** in accordance with subclause (1) for a group of identical **assets** must—
- (a) complete a full set of tests in accordance with clauses 3(a) or (b), 5(a) or (b), and 11(a) or (b), as applicable, on an **asset** that is representative of that group to derive a verified set of modelling parameters and response data; and
 - (b) complete sufficient testing on the remaining **assets** in that group of identical **assets** in accordance with clauses 3(a) or (b), 5(a) or (b), and 11(a) or (b), as applicable, to verify that the performance of the remaining **assets** in that group is fully consistent with the modelling parameters and response data derived from the tests carried out on the representative **asset**; and
 - (c) certify to the **system operator**, that to the best of the **asset owner's** information, knowledge and belief, the performance of that group of **assets** is fully consistent with the representative modelling parameters and response data provided to the **system operator** for that group of **assets**.

Compare: Electricity Governance Rules 2003 clause 14 appendix B technical code A schedule C3 part C

15 Transitional provisions

- (1) Unless a test interval of less than 60 months is specified in this Appendix, each **asset owner** must complete the first of each test required in this Appendix no later than 5 June 2013.
- (2) A test that is required to be carried out in accordance with this Appendix, but that an **asset owner** carried out before 5 June 2008, is deemed to be the first test of that type required in this Appendix, if—
 - (a) the **asset owner** has submitted the relevant written test results to the **system operator**; and
 - (b) the **system operator** has advised the **asset owner** that the specification of the test is acceptable; and
 - (c) the interval between the actual date of the test and the date on which this Code came into force is less than the maximum test interval specified for the corresponding test in this Appendix.
- (3) If a test has been deemed to be the first test in accordance with subclause (2), the date by which the next such test must be carried out must be calculated using the actual date upon which the first test was carried out, not the date upon which it was deemed to have been carried out.

Compare: Electricity Governance Rules 2003 clause 15 appendix B technical code A schedule C3 part C
Clause 15(1): amended, on 21 September 2012, by clause 11(1) of the Electricity Industry Participation (Minor Amendments) Code Amendment 2012.
Clause 15(2): amended, on 21 September 2012, by clause 11(2) of the Electricity Industry Participation (Minor Amendments) Code Amendment 2012.

Technical Code B – Emergencies

1 Purpose and application

The purpose of this **technical code** is to set out the basis on which the **system operator** and **participants** must plan for, anticipate and respond to emergency events on the **grid** that affect the **system operator’s** ability to plan to comply, and to comply with its **principal performance obligations**.

Compare: Electricity Governance Rules 2003 clause 1.1 technical code B schedule C3 part C
Clause 1: amended, on 21 December 2021, by clause 23 of the Electricity Industry Participation Code Amendment (Automatic Under-Frequency Load Shedding Systems) 2021.

2 Application

This **technical code** applies to all **asset owners** except for **excluded generating stations**. If the **system operator** reasonably considers it necessary to assist the **system operator** in planning to comply and complying with the **principal performance obligations**, the **system operator** may require that an **excluded generating station** comply with some or all of the requirements of this **technical code**.

Compare: Electricity Governance Rules 2003 clause 1.2 technical code B schedule C3 part C

3 Obligations of all parties

The **system operator** and all **participants** must plan individually and, if appropriate, collectively, for a **grid emergency**, and act quickly and safely during a **grid emergency** in accordance with this **technical code**, so that the actual and potential impacts of any **grid emergency** are minimised.

Compare: Electricity Governance Rules 2003 clause 2 technical code B schedule C3 part C

4 Obligations of the system operator

The **system operator** must use reasonable endeavours to ensure that—

- (a) if necessary, each **participant** is advised of any independent action required of it if there is a **grid emergency**; and
- (b) **grid owners** or other **asset owners** specify to the **system operator** the facilities they have in place to manually **electrically disconnect demand** at each **point of connection**.

Compare: Electricity Governance Rules 2003 clause 3 technical code B schedule C3 part C
Clause 4: amended, on 15 May 2014, by clause 12 of the Electricity Industry Participation (Minor Code Amendments) Code Amendment 2014.
Clause 4(b): amended, on 5 October 2017, by clause 122 of the Electricity Industry Participation Code Amendment (Code Review Programme) 2017.
Clause 4(b): amended, on 1 March 2024, by clause 31 of the Electricity Industry Participation Code Amendment (Code Review Programme) 2024.

5 Formal notices and responses

- (1) The **system operator** must issue a notice either orally or in writing to relevant **participants** whenever, or as soon as practicable after, any of the following events has occurred:
 - (a) the ability of the **system operator** to plan to comply, and to comply, with the **principal performance obligations** is at risk or is compromised (as set out in the

policy statement):

- (b) public safety is at risk:
 - (c) there is a risk of significant damage to **assets**:
 - (d) independent action has been taken in accordance with this **technical code** to restore the **system operator's principal performance obligations**:
 - (e) an **unsupplied demand situation**.
- (1A) *[Revoked]*
- (1B) *[Revoked]*
- (1C) *[Revoked]*
- (2) The **system operator** must ensure that a **formal notice** issued in accordance with subclause (1) includes the following:
- (a) the electrical or geographical region affected by the notice:
 - (b) the potential consequences of the situation:
 - (c) the responses requested of **participants**:
 - (d) the start time and end time of the situation to which the notice applies.
- (3) The **system operator** must record the issue of a **formal notice**, and each **participant** must record receipt of a **formal notice**.
- (4) If the **system operator** issues a request in accordance with this **technical code** to a **participant**, the **participant** must use reasonable endeavours to respond to the request.

Compare: Electricity Governance Rules 2003 clause 4 technical code B schedule C3 part C

Clause 5(1)(d): inserted, on 1 November 2022, by clause 8(1) of the Electricity Industry Participation Code Amendment (Real Time Pricing) 2022.

Clause 5(1A): inserted, on 1 June 2013, by clause 5(a) of the Electricity Industry Participation (Scarcity Pricing) Code Amendment 2011.

Clause 5(1A): amended, on 5 October 2017, by clause 123 of the Electricity Industry Participation Code Amendment (Code Review Programme) 2017.

Clause 5(1A): amended, on 20 December 2021, by clause 17 of the Electricity Industry Participation Code Amendment (Code Review Programme) 2019. Clause 5(1B): inserted, on 1 June 2013, by clause 5(a) of the Electricity Industry Participation (Scarcity Pricing) Code Amendment 2011. Clause 5(1C): inserted, on 1 June 2013, by clause 5(a) of the Electricity Industry Participation (Scarcity Pricing) Code Amendment 2011.

Clause 5(1A), (1B) and (1C): revoked, on 1 November 2022, by clause 8(2) of the Electricity Industry Participation Code Amendment (Real Time Pricing) 2022. Clause 5(2): amended, on 1 June 2013, by clause 5(b) of the Electricity Industry Participation (Scarcity Pricing) Code Amendment 2011.

Clause 5(2): amended, on 1 November 2022, by clause 8(3) of the Electricity Industry Participation Code Amendment (Real Time Pricing) 2022. Clause 5(2)(d): amended, on 19 January 2017, by clause 4 of the Electricity Industry Participation Code Amendment (Scarcity Pricing) 2016.

5A Request to inform the system operator of available discretionary demand

- (1) A **connected asset owner** must, as soon as reasonably practicable following a request by the **system operator**, inform the **system operator** of their available **discretionary demand** using a method or form agreed with the **system operator**. The **connected asset owner** must agree a method or form for providing such information with the **system operator** by 31 May 2023. Failing such agreement, the **connected asset owner** will be required to provide this information to the **system operator** by submitting **difference bids**.
- (2) For the purposes of subclauses (3) and (4), a **connected asset owner** who submits **difference bids** to the **system operator** under subclause (1) is deemed to be a **purchaser** who purchases **non-dispatch-capable load** at a **conforming GXP** for the purposes of clauses 13.7AA, 13.7AC, 13.7AD, 13.13(2), 13.15, 13.16 and 13.19A.

- (3) If the **system operator** requests information regarding available **discretionary demand** under subclause (1), a **connected asset owner** who submits **difference bids** must, as soon as reasonably practicable following a request by the **system operator**—
- (a) submit to the **system operator** for each **trading period** notified by the **system operator** a **difference bid** that represents a reasonable estimate of the available **discretionary demand** which the **connected asset owner** can use to decrease its **demand**—
 - (i) at each **conforming GXP** in the **connected asset owner's** network or at a **conforming GXP** nominated by the **system operator** and agreed with the **connected asset owner**; and
 - (ii) for the **trading period**; and
 - (iii) at a single price band of \$9000 per **MWh**; and
 - (b) following any **difference bids** submitted under paragraph (a), submit revised **difference bids** to reflect any changes in the **connected asset owner's** estimate of available **discretionary demand**, as soon as reasonably practicable following such changes.
- (4) No later than 5 **business days** following a request or requirement from the **system operator** under this **technical code** to reduce or disconnect **discretionary demand**, a **connected asset owner** who submits **difference bids** to the **system operator** must provide data as reasonably requested by the **system operator** to enable it to confirm the **connected asset owner's** compliance with subclause (3).
- (5) For the purposes of this clause 5A and the definition of **discretionary demand** in Part 1, a **connected asset owner** means a **distributor** in its capacity as the owner or operator of a **local network**, but excludes—
- (a) an **embedded generator**; and
 - (b) an owner or operator of an **embedded network**.
- Clause 5A: inserted, on 3 May 2023, by clause 5 of the Electricity Industry Participation Code Amendment (Discretionary Demand Control) 2023.

6 Actions to be taken by the system operator in a grid emergency

- (1) If an **unsupplied demand situation**, or insufficient generation and **frequency keeping** gives rise to a **grid emergency**, the **system operator** may, having regard to the priority below, if practicable, and regardless of whether a **formal notice** has been issued, do 1 or more of the following:
- (a) request that a **generator** varies its **offer** and **dispatch** the **generator** in accordance with that **offer**, to ensure there is sufficient generation and **frequency keeping**;
 - (b) request that a **purchaser** or a **connected asset owner** reduce **demand**;
 - (c) require a **grid owner** to reconfigure the **grid**;
 - (d) require the **electrical disconnection** of **demand** in accordance with clause 7(20);
 - (e) take any other reasonable action to alleviate the **grid emergency**.
- (2) If insufficient transmission capacity gives rise to a **grid emergency**, the **system**

operator may, having regard to the priority below, if practicable, and regardless of whether a **formal notice** has been issued, do 1 or more of the following:

- (a) request that a **generator** varies its **offer** and **dispatch** the **generator** in accordance with that **offer**, to ensure that the available transmission capacity within the **grid** is sufficient to transmit the remaining level of **demand**;
 - (b) request that an **asset owner** restores its **assets** that are not in service;
 - (c) request that a **purchaser** or **connected asset owner** reduces its **demand**;
 - (d) require the **electrical disconnection of demand** in accordance with clause 7(20);
 - (e) take any other reasonable action to alleviate the **grid emergency**.
- (3) If frequency is outside the **normal band** and all available **injection** has been **dispatched**, the **system operator** may require the **electrical disconnection of demand** in accordance with clause 7(20) in appropriate block sizes until frequency is restored to the **normal band**.
- (4) If any **grid** voltage reaches the minimum voltage limit set out in the table contained in clause 8.22(1), and is sustained at or below that limit, the **system operator** may require the **electrical disconnection of demand** in accordance with clause 7(20) in appropriate block sizes until the voltage is restored to above the minimum voltage limit.
- (5) The **system operator** may, if an unexpected event occurs giving rise to a **grid emergency**, take any reasonable action to alleviate the **grid emergency**.

Compare: Electricity Governance Rules 2003 clause 5 technical code B schedule C3 part C

Clause 6: amended, on 5 October 2017, by clause 124 of the Electricity Industry Participation Code Amendment (Code Review Programme) 2017.

Clause 6(1)(b): amended, on 1 February 2016, by clause 19 of the Electricity Industry Participation Code Amendment (Code Review Programme) 2015.

Clause 6(1)(d), amended, on 7 August 2014, by clause 20(1) of the Electricity Industry Participation Code Amendment (Extended Reserve) 2014.

Clause 6(2)(c): amended, on 1 February 2016, by clause 19 of the Electricity Industry Participation Code Amendment (Code Review Programme) 2015.

Clause 6(2)(d): amended, on 7 August 2014, by clause 20(1) of the Electricity Industry Participation Code Amendment (Extended Reserve) 2014.

Clause 6(3): amended, on 7 August 2014, by clause 20(2) of the Electricity Industry Participation Code Amendment (Extended Reserve) 2014.

Clause 6(4): amended, on 7 August 2014, by clause 20(1) of the Electricity Industry Participation Code Amendment (Extended Reserve) 2014.

Clause 6(1)(d), (2)(d), 3 and 4: amended, on 21 December 2021, by clause 24 of the Electricity Industry Participation Code Amendment (Automatic Under-Frequency Load Shedding Systems) 2021

Clause 6(1): amended, on 1 November 2022, by clause 9 of the Electricity Industry Participation Code Amendment (Real Time Pricing) 2022.

7 Load shedding systems

- (1) Each North Island **connected asset owner** must ensure, at all times, that an **automatic under-frequency load shedding** system is installed in accordance with subclauses (6) and (6AA).
- (2) Every South Island **grid owner** must ensure, at all times, that an **automatic under-frequency load shedding system** is installed in accordance with subclause (6A) for each **grid exit point** in the South Island.
- (3) Subject to subclause (8), each **connected asset owner** and **grid owner** must use reasonable endeavours to ensure that at all times its **automatic under-frequency load shedding** systems are maintained in accordance with subclauses (6) and (6AA) or (6A) as applicable.

- (4) If, at any time, a North Island **connected asset owner** believes that an **automatic under-frequency load shedding** system may not be capable of meeting the requirements of subclauses (6) or (6AA) or a South Island **grid owner** believes that an **automatic under-frequency load shedding** system may not be capable of meeting the requirements of subclause (6A), the relevant **connected asset owner** or **grid owner** must notify the **system operator** as soon as practicable and provide any information that the **system operator** reasonably requests.
- (5) Each South Island **connected asset owner** must co-operate fully with any **grid owner** in relation to an **automatic under frequency load shedding** system installed at any **grid exit points** at which the **connected asset owner** is connected to the **grid**. Each South Island **connected asset owner** must also provide the **grid owner** with any information relating to **automatic under-frequency load shedding** that the **grid owner** reasonably requests.
- (6) An **automatic under-frequency load shedding** system required to be provided in accordance with subclause (1) must enable, at all times, automatic **electrical disconnection of demand** either—
- (a) as 2 blocks of **demand** (each block being a minimum of 16% of the **connected asset owner's** total pre-event **demand**), with—
 - (i) block 1 **electrically disconnecting demand** within 0.4 seconds after the frequency reduces to, and remains at or below, 47.8 Hertz; and
 - (ii) block 2 **electrically disconnecting demand**—
 - (A) 15 seconds after the frequency reduces to, and remains at or below, 47.8 Hertz; and
 - (B) within 0.4 seconds after the frequency reduces to, and remains at or below, 47.5 Hertz; or
 - (b) in accordance with the **system operator's AUFLS technical requirements report**, as agreed with the **system operator** and subject to subclause (6AA).
- (6AA) Each North Island **connected asset owner** must transition as soon as reasonably practicable, and must be proactively engaging with the **system operator** to transition as soon as reasonably practicable, to an **automatic under-frequency load shedding** system that complies with the **system operator's AUFLS technical requirements report**. The transition must be completed before 30 June 2025.
- (6A) An **automatic under-frequency load shedding** system required to be provided in accordance with subclause (2) must enable, at all times, automatic **electrical disconnection** of 2 blocks of **demand** (each block being a minimum of 16% of the **grid owner's** total pre-event **demand**) subject to subclause (8), with—
- (a) block 1 **electrically disconnecting demand** within 0.4 seconds after the frequency reduces to, and remains at or below, 47.5 Hertz; and
 - (b) block 2 **electrically disconnecting demand**—
 - (i) 15 seconds after the frequency reduces to, and remains at or below, 47.5 Hertz; and
 - (ii) within 0.4 seconds after the frequency reduces to, and remains at or below, 46.5 Hertz.

- (7) To avoid doubt, the **demand** calculated to comprise **automatic under-frequency load shedding** blocks must be net of any **interruptible load** procured by the **system operator**.
- (8) Subject to the **system operator's** agreement, which must not be unreasonably withheld, a **grid owner** may redistribute **automatic under-frequency load shedding** quantities between **grid exit points**, if the overall **automatic under-frequency load shedding** quantity obligations in subclause (6A) are met.
- (9) In addition to their obligations to provide information under clauses 6 and 7 of Appendix B of **Technical Code A**, each North Island **connected asset owner** and each South Island **grid owner** must provide **automatic under-frequency load shedding** block **demand** profile information to the **system operator** if reasonably requested by the **system operator**. For each North Island **connected asset owner** that information must be in the form, and supplied by the date, specified by the **system operator** in the **AUFLS technical requirements report**. For each South Island **grid owner** that information must be in the form specified by the **system operator** in the relevant **asset capability statement**.
- (9A) If requested by the **Authority**, the **system operator** must provide information it obtains under clauses 6 and 7 of Appendix B of **Technical Code A** and subclause (9) of this clause to the **Authority**, supplemented by the **system operator's** assessment, based on its analysis of that information, as to whether the **automatic under-frequency load shedding** scheme is secure.
- (10) Subclauses (12) to (16) apply if a direction under clause 9.15 is in force.
- (11) When subclauses (12) to (16) apply, the **system operator** may give notice to 1 or more of the **participants** specified in subclause (14), specifying modifications to the extent to which subclauses (1) to (4), (6), (6AA) and (6A) apply to the **participant** during any 1 or more periods, or in any 1 or more circumstances, specified in the notice.
- (12) The **system operator** must keep a record of each notice given under subclause (11).
- (13) When a notice under subclause (11) is in force in relation to a **participant**, the requirements of subclauses (1) to (4), (6), (6AA) and (6A) are modified for that **participant** to the extent, and during the periods, or in the circumstances (as the case may be), specified in the notice.
- (14) The participants to whom the **system operator** may issue a notice in accordance with subclause (11) are—
 - (a) **connected asset owners** in the North Island;
 - (b) **grid owners** in the South Island.
- (15) The **system operator** may amend or revoke a notice, or revoke and substitute a new notice.
- (16) A notice under subclause (11) expires on the earlier of—
 - (a) the date (if any) specified in the notice for its expiry;
 - (b) the revocation or expiry of the direction referred to in subclause (10).
- (17) The **system operator**, each **connected asset owner**, each **grid owner** and each relevant **retailer** must, to the extent reasonably practicable, co-operate to ensure that any **interruptible load** contracted by the **system operator** that could affect the size of an **automatic under-frequency load shedding** block is identified to assist the **connected**

- asset owner** or the **grid owner** to meet its obligations in subclauses (1) to (9).
- (18) On the operation of an **automatic under-frequency load shedding** system, the **connected asset owner** or **grid owner**—
- (a) must, as soon as practicable, advise the **system operator** of the operation of the **automatic under-frequency load shedding** system and, if reasonably required by the **system operator** to plan to comply, or to comply, with its **principal performance obligations**, a reasonable estimate of the amount of **demand** that has been **electrically disconnected**; and
 - (b) may **electrically connect** the **demand electrically disconnected** through the **automatic under-frequency load shedding** system only when permitted to do so by the **system operator**; and
 - (c) must ensure **demand electrically connected** in accordance with paragraph (b) complies with subclauses (6), (6AA) and (6A); and
 - (d) must report to the **system operator** if demand is moved between **points of connection**; and
 - (e) may request permission to **electrically connect demand** from the **system operator** if no instruction to **electrically connect demand** is received from the **system operator** within 15 minutes of the frequency returning to the **normal band**; and
 - (f) may cautiously and gradually **electrically connect** the **demand electrically disconnected** through the **automatic under-frequency load shedding** system if there is a **loss of communication**, after 15 minutes of the **loss of communication** occurring. This restoration must be done only while the frequency is within the **normal band** and the voltage is within the required range. Each **connected asset owner** must immediately cease the restoration of **demand** and, to the extent necessary, **electrically disconnect demand**, if the frequency drops below the **normal band** or the voltage moves outside the required range. As soon as practicable after communications are restored, each **connected asset owner** or each **grid owner** must report to the **system operator** on the status of load restoration and the status of re-arming the **automatic under-frequency load shedding** system; and
 - (g) must provide data detailing the **automatic under-frequency load shedding** system operation as detailed in the **AUFLS technical requirements report** or in a format agreed with the **system operator**.
- (19) Each **connected asset owner** must maintain an up-to-date process for the **electrical disconnection of demand** for **points of connection**, including the specification of the **participant** who will effect the **electrical disconnection of demand**. The **connected asset owner** must obtain agreement for the process from the **system operator** and each **grid owner** (such agreement not to be unreasonably withheld). Each **connected asset owner** must advise the **system operator** of the agreed process in addition to any changes to a process previously advised.
- (20) If the **system operator** requires the **electrical disconnection of demand** in accordance with this **Technical Code**, the **system operator** must instruct **connected asset owners** and **grid owners** (as the case may be) in accordance with the agreed process in

subclause (19) to **electrically disconnect demand** for the relevant **point of connection**. If the **system operator** and a **connected asset owner** or **grid owner** (as the case may be) have not agreed on a process for **electrical disconnection of demand** for a **point of connection**, the **system operator** must instruct **grid owners** to **electrically disconnect demand** directly at the relevant **point of connection**. To the extent practicable, the **system operator** must use reasonable endeavours to ensure equity between **connected asset owners** when instructing the **electrical disconnection of demand**.

- (21) Each **connected asset owner** or **grid owner** must act as instructed by the **system operator** operating in accordance with clauses 6 and 7.

Compare: Electricity Governance Rules 2003 clause 6 technical code B schedule C3 part C

Clause 7: substituted, on 7 August 2014, by clause 21 of the Electricity Industry Participation Code Amendment (Extended Reserve) 2014.

Clause 7: replaced, on 21 December 2021, by clause 25 of the Electricity Industry Participation Code Amendment (Automatic Under-Frequency Load Shedding Systems) 2021.

Clause 7(2): amended, on 19 December 2014, by clause 15 of the Electricity Industry Participation Code Amendment (Minor Code Amendments) (No 3) 2014.

Clause 7(2): amended, on 5 October 2017, by clause 125 of the Electricity Industry Participation Code Amendment (Code Review Programme) 2017.

Clause 7(9A) and (9B): inserted, from 3 January 2013 to 2 October 2013, by clause 4(a) of the Electricity Industry Participation (Automatic Under-Frequency Load Shedding Systems) Code Amendment 2012.

Clause 7(9A) and (9B): inserted, on 2 October 2013, by clause 4(a) of the Electricity Industry Participation (Automatic Under-Frequency Load Shedding Systems) Code Amendment 2013.

Clause 7(9A) and (9B): revoked, on 3 April 2014, by clause 5(a) of the Electricity Industry Participation (Automatic Under-Frequency Load Shedding Systems) Code Amendment 2013.

Clause 7(10): revoked, from 3 January 2013 to 2 October 2013, by clause 4(b) of the Electricity Industry Participation (Automatic Under-Frequency Load Shedding Systems) Code Amendment 2012.

Clause 7(10): revoked, on 2 October 2013, by clause 4(b) of the Electricity Industry Participation (Automatic Under-Frequency Load Shedding Systems) Code Amendment 2013.

Clause 7(10): inserted, on 3 April 2014, by clause 5(b) of the Electricity Industry Participation (Automatic Under-Frequency Load Shedding Systems) Code Amendment 2013.

Clause 7(11): amended, from 3 January 2013 to 2 October 2013, by clause 4(c) of the Electricity Industry Participation (Automatic Under-Frequency Load Shedding Systems) Code Amendment 2012.

Clause 7(11): amended, on 2 October 2013, by clause 4(c) of the Electricity Industry Participation (Automatic Under-Frequency Load Shedding Systems) Code Amendment 2013.

Clause 7(11): amended, on 3 April 2014, by clause 5(c) of the Electricity Industry Participation (Automatic Under-Frequency Load Shedding Systems) Code Amendment 2013.

Clause 7(12A) and (12B): inserted, from 3 January 2013 to 2 October 2013, by clause 4(d) of the Electricity Industry Participation (Automatic Under-Frequency Load Shedding Systems) Code Amendment 2012.

Clause 7(12A) and (12B): inserted, on 2 October 2013, by clause 4(d) of the Electricity Industry Participation (Automatic Under-Frequency Load Shedding Systems) Code Amendment 2013.

Clause 7(12A) and (12B): revoked, on 3 April 2014, by clause 5(d) of the Electricity Industry Participation (Automatic Under-Frequency Load Shedding Systems) Code Amendment 2013.

Clause 7(13): amended, from 3 January 2013 to 2 October 2013, by clause 4(e) of the Electricity Industry Participation (Automatic Under-Frequency Load Shedding Systems) Code Amendment 2012.

Clause 7(13): amended, on 2 October 2013, by clause 4(e) of the Electricity Industry Participation (Automatic Under-Frequency Load Shedding Systems) Code Amendment 2013.

Clause 7(13): amended, on 3 April 2014, by clause 5(e) of the Electricity Industry Participation (Automatic Under-Frequency Load Shedding Systems) Code Amendment 2013.

Clause 7(15): amended, from 3 January 2013 to 2 October 2013, by clause 4(f) of the Electricity Industry Participation (Automatic Under-Frequency Load Shedding Systems) Code Amendment 2012.

Clause 7(15): amended, on 2 October 2013, by clause 4(f) of the Electricity Industry Participation (Automatic Under-Frequency Load Shedding Systems) Code Amendment 2013.

Clause 7(15): amended, on 3 April 2014, by clause 5(f) of the Electricity Industry Participation (Automatic Under-Frequency Load Shedding Systems) Code Amendment 2013.

Clause 7(16): substituted, from 3 January 2013 to 2 October 2013, by clause 4(g) of the Electricity Industry Participation (Automatic Under-Frequency Load Shedding Systems) Code Amendment 2012.

Clause 7(16): substituted, on 2 October 2013, by clause 4(g) of the Electricity Industry Participation (Automatic Under-Frequency Load Shedding Systems) Code Amendment 2013.

Clause 7(16): substituted, on 3 April 2014, by clause 5(g) of the Electricity Industry Participation (Automatic Under-Frequency Load Shedding Systems) Code Amendment 2013.

Clause 7(16A) and (16B): inserted, from 3 January 2013 to 2 October 2013, by clause 4(g) of the Electricity Industry Participation (Automatic Under-Frequency Load Shedding Systems) Code Amendment 2012.

Clause 7(16A) and (16B): inserted on 2 October 2013, by clause 4(g) of the Electricity Industry Participation (Automatic Under-Frequency Load Shedding Systems) Code Amendment 2013.

Clause 7(16A) and (16B): revoked on 3 April 2014, by clause 5(g) of the Electricity Industry Participation (Automatic Under-Frequency Load Shedding Systems) Code Amendment 2013.

7A *[Revoked]*

Clause 7A: inserted, on 7 August 2014, by clause 21 of the Electricity Industry Participation Code Amendment (Extended Reserve) 2014.

Clause 7A(1), (2), (5), (6) and (7): amended, on 5 October 2017, by clause 126 of the Electricity Industry Participation Code Amendment (Code Review Programme) 2017.

Clause 7A(1), (3), (4), (5), (6), (7) and (8): amended, on 1 February 2016, by clause 20 of the Electricity Industry Participation Code Amendment (Code Review Programme) 2015.

Clause 7A: revoked, on 21 December 2021, by clause 26 of the Electricity Industry Participation Code Amendment (Automatic Under-Frequency Load Shedding Systems) 2021.

7B *[Revoked]*

Clause 7B: inserted, on 7 August 2014, by clause 21 of the Electricity Industry Participation Code Amendment (Extended Reserve) 2014.

Clause 7B: amended, on 5 October 2017, by clause 127 of the Electricity Industry Participation Code Amendment (Code Review Programme) 2017.

Clause 7B: revoked, on 21 December 2021, by clause 27 of the Electricity Industry Participation Code Amendment (Automatic Under-Frequency Load Shedding Systems) 2021.

7C *[Revoked]*

Clause 7C: inserted, on 7 August 2014, by clause 21 of the Electricity Industry Participation Code Amendment (Extended Reserve) 2014.

Clause 7C(5)(a): amended, on 1 February 2016, by clause 21 of the Electricity Industry Participation Code Amendment (Code Review Programme) 2015.

Clause 7C: revoked, on 21 December 2021, by clause 28 of the Electricity Industry Participation Code Amendment (Automatic Under-Frequency Load Shedding Systems) 2021.

8 Obligations of grid owners

- (1) A **grid owner** must use reasonable endeavours to ensure that appropriate **assets** are installed for the manual **electrical disconnection of demand** at **points of connection**.
- (2) A **grid owner** must take independent action as may be required by the **system operator** in accordance with clause 6(4), to **electrically disconnect demand** at **points of connection** when any **grid** voltage reaches the minimum voltage limit set out in the table contained in clause 8.22(1) and is sustained at or below that level. A **grid owner** must continue to **electrically disconnect demand** at **points of connection** while the voltage remains below that minimum voltage limit, being guided by any arrangements with **connected asset owners** as advised by the **system operator**.

Compare: Electricity Governance Rules 2003 clause 7 technical code B schedule C3 part C

Clause 8(2): amended, on 1 February 2016, by clause 22 of the Electricity Industry Participation Code Amendment (Code Review Programme) 2015.

Clause 8(1) and (2): amended, on 5 October 2017, by clause 128(1) and (2) of the Electricity Industry Participation Code Amendment (Code Review Programme) 2017.

9 Obligations of generators and ancillary service agents to take independent action

The following independent action is required of **generators** and **ancillary service agents** during the occurrence of extreme variations of frequency or voltage at the **points of connection** to which their **assets** are connected (such extreme levels of frequency or voltage are deemed to constitute a **grid emergency** and require a fast and independent

response from each **generator** and each **ancillary service agent**):

- (a) when the **under-frequency limit** is reached and the frequency continues to fall, each **generator** must use reasonable endeavours to take the following immediate independent action to assist in restoring frequency:
 - (i) increase the energy **injection** from each **generating unit** that is physically capable of increasing such **injection**;
 - (ii) attempt to restore **grid** frequency to the **normal band** by **synchronising** and loading each **generating unit** that is not **electrically connected** but is able to be **electrically connected** and operated in this manner;
 - (iii) **re-synchronise** and load each **generating unit** that has tripped and is able to be **electrically connected** and operated in this manner;
 - (iv) report to the **system operator** as soon as practicable after taking action in accordance with subparagraphs (i) to (iii):
- (b) when the **over frequency limit** is reached and the frequency continues to rise, each **generator** must use reasonable endeavours to take the following immediate independent action to assist in restoring frequency:
 - (i) decrease the energy injection from **electrically connected generating units** if the **generator** is physically capable of decreasing such **injection**;
 - (ii) report to the **system operator** as soon as practicable after taking action in accordance with subparagraph (i):
- (c) when either the minimum voltage limit or the maximum voltage limit set out in the table contained in clause 8.22(1) is exceeded at any **point of connection**;
 - (i) **generators** and **ancillary service agents** must use reasonable endeavours to take immediate independent action to return the voltage to, as close as practicable, within such limits;
 - (ii) each **generator** must use reasonable endeavours to **synchronise** and, as necessary, load and adjust all available **generating units** that can assist in restoring the voltage;
 - (iii) **ancillary service agents** must use reasonable endeavours to **electrically connect** to the **grid** and, as necessary, load all available **reactive capability** resources, that can assist in restoring the voltage;
 - (iv) as soon as practicable after taking the actions described in subparagraphs (i) to (iii), each **generator** and **ancillary service agent** must report to the **system operator** on the action taken to correct voltage:
- (d) for a **loss of communication** with the **system operator**, lasting at least 5 minutes, each **generator** must use reasonable endeavours to—
 - (i) for **synchronised generating units**, take independent action to adjust supply to maintain frequency as close as possible to the **normal band**, and maintain voltage as close as possible either to that previously advised by the **system operator**, or as can be best established by the **generator**; and
 - (ii) **synchronise** available **generating units** to the **grid** if the **generating units** currently **electrically connected** do not have the capacity to control the frequency and voltage as required by paragraph (e)(i); and
 - (iii) continue to attempt to maintain the frequency and voltage to meet the requirements of paragraph (e)(i); and

- (iv) as soon as practicable after communications are restored, report to the **system operator** on the action taken:
- (e) for a **loss of communication** with the **system operator** lasting at least 5 minutes, **ancillary service agents** must use reasonable endeavours to—
 - (i) if on load, take independent action to adjust any real or **reactive power** resources to maintain frequency and voltage as close as possible either to that previously advised by the **system operator** or as can be best established by the **ancillary service agent**; and
 - (ii) **electrically connect** available **reactive capability** resources to the **grid** if the currently **electrically connected reactive power** resources do not have the capacity to control the voltage above the minimum limit set out in the table contained in clause 8.22(1); and
 - (iii) continue to attempt to maintain the voltage above the minimum limit set out in the table contained in clause 8.22(1); and
 - (iv) as soon as practicable after communications are restored, report to the **system operator** on the action taken:
- (f) in the event of a failure at the **system operator's** operational centre that disables the main **dispatch** or communication systems, the **system operator** may temporarily transfer its operational activities to an alternative operational centre. If the **system operator** makes such a transfer, the **system operator** must:
 - (i) arrange for communication facilities to transfer to the new location; and
 - (ii) give written notice to **participants** of those arrangements.

Compare: Electricity Governance Rules 2003 clause 8 technical code B schedule C3 part C

Clause 9: amended, on 23 February 2015, by clause 75 of the Electricity Industry Participation Code Amendment (Distributed Generation) 2014.

Clause 9: amended, on 5 October 2017, by clause 129 of the Electricity Industry Participation Code Amendment (Code Review Programme) 2017.

Clause 9(c): replaced, on 20 December 2021, by clause 18(1) of the Electricity Industry Participation Code Amendment (Code Review Programme) 2019.

Clause 9(f): replaced, on 20 December 2021, by clause 18(2) of the Electricity Industry Participation Code Amendment (Code Review Programme) 2019.

Technical Code C – Operational communications

1 Purpose

The purpose of this **technical code** is to state the minimum requirements for the communications required under this Code between **asset owners**, except owners of **excluded generating stations**, and the **system operator**, in order to assist the **system operator** to plan to comply, and to comply, with the **principal performance obligations**. Additional requirements may be set out in other clauses. This **technical code** does not deal with the content of communications, which is dealt with in each **technical code** and in Part 13 where relevant.

Compare: Electricity Governance Rules 2003 clause 1.1 technical code C schedule C3 part C

2 Application

This **technical code** applies to the **system operator** and to all **asset owners** except owners of **excluded generating stations**. If the **system operator** reasonably considers it necessary to assist the **system operator** in planning to comply, and complying, with the **principal performance obligations**, the **system operator** may require that an **excluded generating station** comply with some or all of the requirements of this **technical code**.

Compare: Electricity Governance Rules 2003 clause 1.2 technical code C schedule C3 part C

3 General requirements for operational communications

- (1) Each voice or electronic communication between the **system operator** and an **asset owner** must be logged by the **system operator** and the **asset owner**. Unless otherwise agreed between the **system operator** and the **asset owner**, every voice instruction must be repeated back by the person receiving the instruction and confirmed by the person giving the instruction before the instruction is actioned.
- (2) The **system operator** and each **asset owner** must nominate and advise each other of the preferred points of contact and the alternative points of contact to be used by the **system operator** and the **asset owner**. Each **asset owner** must also nominate and advise the **system operator** of the person to receive instructions and **formal notices** as set out in **Technical Code B**. The preferred points of contact must include those to be used when the **system operator** instructs the **asset owner**, when the **system operator** sends **formal notices** to the **asset owner** and when the **asset owner** contacts the **system operator**. The alternative points of contact must be used only if the preferred points of contact are not available.
- (3) The **grid owner** and each other **asset owner** must nominate and advise each other of the preferred points of contact and the alternative points of contact to be used by the **grid owner** and the other **asset owner** for the purpose of communications regarding the availability of the **grid owner's** data transmission communications. The alternative points of contact must only be used if the preferred points of contact are not available.

Compare: Electricity Governance Rules 2003 clause 2 technical code C schedule C3 part C

4 Specific requirements for voice communication

- (1) Each **asset owner** must have in place a primary means of communicating by voice between the **control room** of the **asset owner** and the **system operator**. The primary means of voice communication must use either—
 - (a) the **grid owner's** speech network; or
 - (b) a widely available public switched telephone network that operates in real time and in full duplex mode.
- (2) Each **asset owner** must have in place a backup means of communicating by voice between the **control room** of the **asset owner** and the **system operator**. The backup means of voice communication—
 - (a) must be approved by the **system operator** (such approval not to be unreasonably withheld); and
 - (b) may include, but is not limited to, satellite phone or cellular phone; and
 - (c) may be used only if the primary means of voice communication described in subclause (1) is unavailable or otherwise with the agreement of the **system operator**.
- (3) An **asset owner** who has a **control room** with, at any time, operational control of more than 299 MW of **injection, offtake**, or power flow must have 2 or more back up means of voice communication between the **control room** of the **asset owner** and the **system operator**, each of which must meet the requirements of subclause (2).

Compare: Electricity Governance Rules 2003 clause 3 technical code C schedule C3 part C

5 Specific requirements for transmitting information

- (1) Each **asset owner** must transmit information between its **control room** and the **system operator** in writing.
- (2) Despite subclause (1), an **asset owner** may request the **system operator** to approve an alternative means of transmitting information (such approval not to be unreasonably withheld).
- (3) Each **asset owner** must have in place a backup means of transmitting information. The backup means of transmitting information—
 - (a) must be approved by the **system operator** (such approval not to be unreasonably withheld); and
 - (b) may include, but is not limited to, voice communication or email; and
 - (c) may only be used if the primary means of transmitting information described in subclause (1) or (2) is unavailable or otherwise with the agreement of the **system operator**.

Compare: Electricity Governance Rules 2003 clause 4 technical code C schedule C3 part C

Heading: amended, on 5 October 2017, by clause 130(1) of the Electricity Industry Participation Code Amendment (Code Review Programme) 2017.

Clause 5(1): replaced, on 5 October 2017, by clause 130(2) of the Electricity Industry Participation Code Amendment (Code Review Programme) 2017.

Clause 5(2) and (3): amended, on 5 October 2017, by clause 130(3) and (4) of the Electricity Industry Participation Code Amendment (Code Review Programme) 2017.

6 Specific requirements for data transmission communication

- (1) Each **asset owner** (other than a **grid owner**) must have in place—
 - (a) a primary means of transmitting data between the **assets** of the **asset owner** and a **SCADA** remote terminal unit of a **grid owner**; or
 - (b) if approved by the **system operator** (such approval not to be unreasonably withheld), a primary means of transmitting data between the **assets** of the **asset owner** and the **system operator**.
- (2) A **grid owner** must have in place a primary means of transmitting data between the **assets** of the **grid owner** and the **system operator**.
- (3) Each **asset owner** must have in place a backup means of transmitting data for each type of indication and measurement specified in Appendix A of this **technical code**. The backup means of data transmission communication—
 - (a) must be approved by the **system operator** (such approval not to be unreasonably withheld); and
 - (b) may include, but is not limited to, use of voice communication or document transmission communication; and
 - (c) may only be used if the primary means of data transmission communication described in subclause (1) or (2) is unavailable or otherwise with the agreement of the **system operator**.

Compare: Electricity Governance Rules 2003 clause 5 technical code C schedule C3 part C

7 Availability of primary means of communication

- (1) Each **asset owner** must use reasonable endeavours to ensure that the primary means of communication described in clauses 4(1), 5(1) or (2), and 6(1) or (2) is available continuously.
- (2) If the primary means of communication described in clauses 4(1), 5(1) or (2), and 6(1) or (2) is unavailable, an **asset owner** must use reasonable endeavours to restore availability of the primary means of communication as soon as practicable.

Compare: Electricity Governance Rules 2003 clause 6 technical code C schedule C3 part C

8 Notice of planned outages of primary means of communication

Each **asset owner** must give written notice to the **system operator** of any planned outage of a primary means of communication described in clauses 4(1), 5(1) or (2), and 6(1) or (2).

Compare: Electricity Governance Rules 2003 clause 7 technical code C schedule C3 part C

Clause 8 heading: amended, on 1 November 2018, by clause 16 of the Electricity Industry Participation Code Amendment (Code Review Programme) 2018.

Clause 8: amended, on 5 October 2017, by clause 131 of the Electricity Industry Participation Code Amendment (Code Review Programme) 2017.

9 Performance requirements for indications and measurements

- (1) Each **asset owner** must provide the relevant indications and measurements shown in Appendix A to the **system operator**, in accordance with clause 6. The **system operator** may require the **asset owner** to provide additional information if, in the reasonable opinion of the **system operator**, such information is required for the **system operator** to plan to comply, and to comply, with its **principal performance obligations**.

- (2) The **asset owner** must use reasonable endeavours to ensure that the accuracy of the measurements it provides to the **system operator** in accordance with subclause (1) complies with Appendix A.
- (3) Each indication and measurement provided in accordance with subclause (1) must be updated at the **grid owner's SCADA** remote terminal or the **system operator's** interface unit at least once every 8 seconds when provided by the primary means of data transmission communications.

Compare: Electricity Governance Rules 2003 clause 8 technical code C schedule C3 part C

*Appendix A: Indications and Measurements
(Clause 9(1)-(3) of Technical Code C)*

Table A1: Requirements of generators

Each **generator** must provide the indications and measurements in Table A1. If net (or gross) measurements are required in Table A1, the use of **scaling factors** together with the provision of the relevant gross (or net) values is acceptable with the **system operator's** approval. Each **generator** must provide **scaling factors** to the **grid owner** so that the **grid owner** can apply the adjustment at the **SCADA** server.

Indication or measurement	Values required	Accuracy ³
Station net MW	Import and export	±2%
Generating unit gross MW ¹	Import and export, for each generating unit	±2%
Station net Mvar	Import and export	±2%
Generating unit gross Mvar ¹	Import and export, for each generating unit	±2%
Generating unit circuit breaker status ¹	Open /closed /in transition/ indication error ²	N/A
Grid interface circuit breaker status	Open /closed /in transition/ indication error ²	N/A
Grid interface disconnecter status	Open /closed /in transition/ indication error	N/A
Special protection scheme status	Enabled/disabled/summer/winter	N/A
Maximum output capacity of generating station (for intermittent generators only)	Number of connected generating units × MW capability of each generating unit	N/A

Compare: Electricity Governance Rules 2003 table A1 appendix A technical code C schedule C3 part C

Table A1: amended, on 23 February 2015, by clause 75 of the Electricity Industry Participation Code Amendment (Distributed Generation) 2014.

Table A1: amended, on 5 October 2017, by clause 132 of the Electricity Industry Participation Code Amendment (Code Review Programme) 2017.

Table A2: Requirements of grid owners:

Each **grid owner** must provide the indications and measurements shown in Table A2 in respect of **assets** connected to, or forming part of, the **grid**.

Indication or measurement	Values required	Accuracy ³
Grid interface circuit breaker status	Open /closed /in transition/ indication error ²	N/A
Grid interface disconnecter status	Open/ closed/ in transition/ closed to earth/ indication error	N/A
Grid interface auto reclose status	Enabled/disabled/ operated/locked out	N/A
Grid interface MW	Import and export	±2%

Indication or measurement	Values required	Accuracy ³
Grid interface Mvar	Import and export	±2%
Circuit Amps	Current at each termination point of a circuit	N/A
Circuit MW	MW at each termination point of a circuit	N/A
Circuit Mvar	Mvar at each termination point of a circuit	N/A
Tap positions for interconnecting transformers and supply transformers with on-load tap changers	Tap position for all windings including tapped tertiaries	N/A
Tap positions for interconnecting transformers and supply transformers with off-load tap changers ⁴	Tap position for all windings including tapped tertiaries	N/A
Reactive plant (eg RPC equipment, capacitor, reactor, condenser) Mvar	Import and export	±2%
Bus voltage	kV	±2%
Special protection scheme status	Enabled/disabled/summer/winter	N/A
HVDC modulation status	Frequency stabiliser/ spinning reserve sharing/ Haywards frequency control/ AC transient voltage support	N/A

Compare: Electricity Governance Rules 2003 table A2 appendix A technical code C schedule C3 part C
Table A2: amended, on 23 February 2015, by clause 75 of the Electricity Industry Participation Code Amendment (Distributed Generation) 2014.

Table A2: amended, on 5 October 2017, by clause 133 of the Electricity Industry Participation Code Amendment (Code Review Programme) 2017.

Table A2: amended, on 20 December 2021, by clause 19 of the Electricity Industry Participation Code Amendment (Code Review Programme) 2019.

Table A3: Requirements of connected asset owners

Each **connected asset owner** must provide the indications and measurements shown in Table A3 in respect of **assets** connected to, or forming part of, the **grid**.

Indication or measurement	Values required	Accuracy ³
Grid interface circuit breaker status	Open/ closed/ in transition/ indication error ²	N/A
Grid interface disconnecter status	Open/ closed/ in transition/ indication error	N/A
Grid interface auto reclose status	Enabled/disabled/operated/locked out	N/A
Special protection scheme status	Enabled/disabled/summer/winter	N/A
Reactive plant ⁵ (eg RPC equipment, capacitor, reactor, condenser) Mvar	Import and export	±2%

Table A3 Heading: amended, on 1 February 2016, by clause 23(1) of the Electricity Industry Participation Code Amendment (Code Review Programme) 2015.

Table A3: amended, on 23 February 2015, by clause 75 of the Electricity Industry Participation Code Amendment (Distributed Generation) 2014.

Table A3: amended, on 1 February 2016, by clause 23(2) of the Electricity Industry Participation Code Amendment (Code Review Programme) 2015.

Table A3: amended, on 5 October 2017, by clause 134 of the Electricity Industry Participation Code Amendment (Code Review Programme) 2017.

- ¹ Required only if a **generating unit** has a maximum continuous rating of greater than 5 **MW**.
- ² No intentional time delays should be included for **circuit breaker** indications as these are time tagged by the **system operator** to less than 10 ms.
- ³ If accuracy is measured at the input terminal of the RTU of the **grid owner**, under normal operating conditions at full scale.
- ⁴ Indication required within 5 minutes of status change.
- ⁵ Required only if reactive plant has a maximum continuous rating of greater than 5 Mvar.

Compare: Electricity Governance Rules 2003 table A3 appendix A technical code C schedule C3 part C

Technical Code D – Co-ordination of outages affecting common quality

1 Purpose

The purpose of this **technical code** is to set out the obligations of **asset owners** to give written notice of planned outages of **assets** that affect **common quality**, and to set out the obligations of the **system operator** in relation to outage co-ordination and the provision of timely advice to **asset owners** on the security implications of **notified planned outages**.

Compare: Electricity Governance Rules 2003 clause 1 technical code D schedule C3 part C
Clause 1: amended, on 5 October 2017, by clause 135 of the Electricity Industry Participation Code Amendment (Code Review Programme) 2017.

2 Notice of planned outages

- (1) Each **asset owner** must, in relation to each of its **assets**, give written notice to the **system operator** as soon as practicable of all planned outages of such **assets** if such outages may impact on the **system operator's** ability to plan to comply, and to comply, with the **principal performance obligations**.
- (2) If the **asset owner** is unsure whether an outage of an **asset** may impact on the **system operator's** ability to plan to comply, and to comply, with the **principal performance obligations**, the **asset owner** must contact the **system operator** for advice.
- (3) Each **asset owner** must give written notice to the **system operator** up to 12 months ahead of planned outages and update the **system operator** of changes to the planned outages as and when the **asset owner** becomes aware of them.

Compare: Electricity Governance Rules 2003 clause 2 technical code D schedule C3 part C
Heading: amended, on 5 October 2017, by clause 136(1) of the Electricity Industry Participation Code Amendment (Code Review Programme) 2017.
Clause 2(1) and (3): amended, on 5 October 2017, by clause 136(2) of the Electricity Industry Participation Code Amendment (Code Review Programme) 2017.

3 Assessment of notified planned outages

The **system operator** must assess all **notified planned outages** and the extent to which they impact on the **system operator's** ability to plan to comply, and to comply with the **principal performance obligations**.

Compare: Electricity Governance Rules 2003 clause 3 technical code D schedule C3 part C

4 Assets may be requested to remain in service

The **system operator** may request that an **asset owner** of **assets** that are the subject of a **notified planned outage** keep those **assets** in service until a more suitable time, if such outage would, in the reasonable opinion of the **system operator**, adversely affect the **system operator's** ability to plan to comply, and to comply, with the **principal performance obligations**. The **system operator** may propose a suitable alternative time for the **notified planned outage**.

Compare: Electricity Governance Rules 2003 clause 4 technical code D schedule C3 part C

5 Asset owners to assist security

- (1) An **asset owner** must endeavour to programme its **notified planned outage** at a time when there will be no disruption to the **system operator's** ability to plan to comply, and

to comply, with the **principal performance obligations**.

- (2) The **system operator** may advise an **asset owner** when an appropriate time would be.
- (3) If an **asset owner** is able to modify the **notified planned outage** period for an **asset** in the manner suggested by the **system operator** without material cost or disruption, the **asset owner** must endeavour to do so.

Compare: Electricity Governance Rules 2003 clause 5 technical code D schedule C3 part C

6 Asset outage programme

The **system operator** must regularly publish an **asset** outage programme containing all **notified planned outage** information provided by the **asset owners**.

Compare: Electricity Governance Rules 2003 clause 6 technical code D schedule C3 part C

7 Assets may be requested to return to service

The **system operator** may request an **asset owner** to terminate a **notified planned outage** in progress within a pre-arranged period so that **assets** that are the subject of the **notified planned outage** can be returned to service to support the **system operator** in planning to comply, and in complying, with the **principal performance obligations**.

Compare: Electricity Governance Rules 2003 clause 7 technical code D schedule C3 part C

Schedule 8.4
[Revoked]

cl 7.2

Compare: Electricity Governance Rules 2003 schedule C6 part C
Schedule 8.4: revoked, on 19 May 2016, by clause 30 of the Electricity Industry Participation Code Amendment (System Operator and Alignment with Statutory Objective) 2016.

Schedule 8.5
[Revoked]

cl 8.54D(7), 8.54E(4)(b), 8.54F(2)(b)(ii),
8.54G(4), 8.54I(2), 8.54J(8), (9)

Schedule 8.5: inserted, on 7 August 2014, by clause 22 of the Electricity Industry Participation Code Amendment (Extended Reserve) 2014.

Schedule 8.5: revoked, 21 December 2021, by clause 29 of the Electricity Industry Participation Code Amendment (Automatic Under-Frequency Load Shedding Systems) 2021.

Schedule 8.6

cl 1.1

AUFLS technical requirements report incorporated by reference

Schedule 8.6: inserted, 21 December 2021, by clause 30 of the Electricity Industry Participation Code Amendment (Automatic Under-Frequency Load Shedding Systems) 2021.

Schedule 8.6 Heading: amended, on 1 August 2023, by clause 29 of the Electricity Industry Participation Code Amendment (System Operation Documents) 2023.

1 *[Revoked]*

Clause 1: revoked, on 1 August 2023, by clause 30 of the Electricity Industry Participation Code Amendment (System Operation Documents) 2023.

2 **Incorporation of AUFLS technical requirements report by reference**

(1) **The AUFLS technical requirements report** is incorporated by reference in this Code.

(2) Clauses 7.13 to 7.22 apply to any amendment or replacement of the **AUFLS technical requirements report**.

Clause 2(1): amended, on 1 August 2023, by clause 31(1) of the Electricity Industry Participation Code Amendment (System Operation Documents) 2023.

Clause 2(2): amended, on 1 August 2023, by clause 31(2) of the Electricity Industry Participation Code Amendment (System Operation Documents) 2023.

Clause 2(2): amended, on 1 March 2024, by clause 32 of the Electricity Industry Participation Code Amendment (Code Review Programme) 2024

3 *[Revoked]*

Clause 3: revoked, on 1 August 2023, by clause 32 of the Electricity Industry Participation Code Amendment (System Operation Documents) 2023.

4 *[Revoked]*

Clause 4: revoked, on 1 August 2023, by clause 33 of the Electricity Industry Participation Code Amendment (System Operation Documents) 2023.

5 *[Revoked]*

Clause 4: revoked, on 1 August 2023, by clause 34 of the Electricity Industry Participation Code Amendment (System Operation Documents) 2023.

Electricity Industry Participation Code 2010

Part 9 Security of supply

Contents

Subpart 1—Planning for shortage of supply situations

9.1 Purpose

System operator rolling outage plan

9.2 System operator must prepare and publish system operator rolling outage plan

9.3 Incorporation of system operator rolling outage plan by reference

9.4 Contents of system operator rolling outage plan

9.5 *[Revoked]*

Participant rolling outage plans

9.6 System operator must require specified participants to develop participant rolling outage plans

9.7 Specified participants must develop participant rolling outage plans

9.8 Contents of participant rolling outage plans

9.9 Approval of participant rolling outage plans

9.10 Revision of participant rolling outage plans

9.11 Approval of revised participant rolling outage plans

9.12 Publishing of participant rolling outage plans

9.13 Specified participants must keep participant rolling outage plans up to date

Subpart 1A—Urgent temporary grid reconfigurations

9.13A Purpose

9.13B Request for urgent temporary grid reconfiguration

Subpart 2—Outages in shortage of supply situation

9.14 Supply shortage declaration

9.15 Power to direct outages in security of supply situation

9.16 Specified participants must comply with direction

9.17 Revocation of supply shortage declaration

Subpart 3—Miscellaneous

9.18 Provision of information

Subpart 4—Customer compensation schemes

9.19 Contents of this subpart

Requirement for retailers to have customer compensation scheme

9.20 Retailer must have customer compensation scheme

9.21 Qualifying customers

9.22 Requirement to implement customer compensation schemes

Official conservation campaign

9.23 System operator commences official conservation campaign

9.23A System operator ends official conservation campaign

Default customer compensation scheme

9.24 Requirements of default customer compensation schemes

Minimum weekly amount of compensation

9.25 Authority must determine minimum weekly amount

Additional customer compensation schemes

9.26 Retailer may have additional customer compensation schemes

9.27 Qualifying customer may elect to be covered by additional customer compensation scheme

9.28 Publishing description of additional customer compensation schemes

Certificate of compliance

9.29 Each retailer must provide certification

Audit

9.30 Audit of compliance

9.31 Retailer must provide information to auditor

9.32 Auditor must provide audit report

9.33 Payment of auditor's costs

Subpart 1— Planning for shortage of supply situations

9.1 Purpose

The purpose of this subpart and subpart 2 is to provide for the management and co-ordination of planned outages as an emergency measure during energy shortages.

Compare: SR 2008/252 r 3

System operator rolling outage plan

9.2 System operator must prepare and publish system operator rolling outage plan

(1) The **system operator** must prepare and **publish a system operator rolling outage plan**.

(2) *[Revoked]*

(3) *[Revoked]*

Compare: SR 2008/252 r 5

Clause 9.2(2) and (3): revoked, on 1 March 2024, by clause 33 of the Electricity Industry Participation Code Amendment (Code Review Programme) 2024.

9.3 Incorporation of system operator rolling outage plan by reference

(1) The **system operator rolling outage plan** is incorporated by reference in this Code.

(2) Clauses 7.13 to 7.22 apply to any amendment or replacement of the **system operator rolling outage plan**.

Clause 9.3(1): amended, on 5 October 2017, by clause 144 of the Electricity Industry Participation Code Amendment (Code Review Programme) 2017.

Clause 9.3(1): amended, on 1 March 2024, by clause 34(1) of the Electricity Industry Participation Code Amendment (Code Review Programme) 2024.

Clause 9.3(2): replaced, on 1 March 2024, by clause 34(2) of the Electricity Industry Participation Code Amendment (Code Review Programme) 2024.

9.4 Contents of system operator rolling outage plan

A **system operator rolling outage plan** must—

- (a) describe events that the **system operator** predicts will be likely to give rise to the need to make a **supply shortage declaration**; and
- (b) set out thresholds that the **system operator** will apply in deciding whether to make a **supply shortage declaration**; and
- (c) specify how the **system operator** intends to determine what directions to give to address the shortage of **electricity** supply or transmission capacity that gives rise to the declaration; and
- (d) identify **specified participants**, or a class or classes of **specified participants**, who are required to develop **participant rolling outage plans** under clauses 9.6 to 9.13; and
- (e) specify criteria, methodologies, and principles to be applied in implementing outages, or taking any other action, to be provided for in **participant rolling outage plans**; and
- (f) specify criteria, methodologies, and principles to be applied by any **specified participant** who does not have an approved **participant rolling outage plan** in implementing outages, or taking any other action, in accordance with directions given by the **system operator** under clause 9.15.

Compare: SR 2008/252 r 6

9.5 *[Revoked]*

clause came into force.

Compare: SR 2008/252 r 7 and 8

Clause 9.5(4): amended, on 5 October 2017, by clause 145(a) of the Electricity Industry Participation Code Amendment (Code Review Programme) 2017.

Clause 9.5(4)(c): amended, on 5 October 2017, by clause 145(b) of the Electricity Industry Participation Code Amendment (Code Review Programme) 2017.

Clause 9.5: revoked, on 1 March 2024, by clause 35 of the Electricity Industry Participation Code Amendment (Code Review Programme) 2024.

Participant rolling outage plans

9.6 **System operator must require specified participants to develop participant rolling outage plans**

- (1) This clause applies when a **specified participant** is identified under a **system operator rolling outage plan** as being required to develop a **participant rolling outage plan**.
- (2) The **system operator** must send notice in writing to that **specified participant** of that requirement, including—
 - (a) specifying the requirements that the **participant rolling outage plan** must comply with under this Part and the **system operator rolling outage plan**; and
 - (b) specifying a date by which the **specified participant** must submit that plan to the **system operator**.
- (3) The **system operator** must send the notice under subclause (2) as soon as practicable after the **system operator publishes** its **system operator rolling outage plan**.

Compare: SR 2008/252 r 8A

9.7 Specified participants must develop participant rolling outage plans

- (1) Each **specified participant** who receives a notice under clause 9.6 must develop its **participant rolling outage plan** in accordance with the notice.
- (2) The **specified participant** must submit the plan to the **system operator** by the date specified under clause 9.6(2)(b).

Compare: SR 2008/252 r 8B

9.8 Contents of participant rolling outage plans

- (1) Each **participant rolling outage plan** must—
 - (a) be consistent with the **system operator rolling outage plan**; and
 - (b) comply with the requirements specified in the notice sent under clause 9.6(2)(a); and
 - (c) specify the actions that the **specified participant** will take to achieve, or contribute to achieving, reductions in the consumption of **electricity** (including any target level of reduction of consumption of **electricity** in accordance with criteria, methodologies, and principles specified in the **system operator rolling outage plan**) to comply with a direction from the **system operator** given under clause 9.15.
- (2) This clause does not limit clause 9.6(2)(a).

Compare: SR 2008/252 r 8C

9.9 Approval of participant rolling outage plans

- (1) The **system operator** must, as soon as practicable after receiving a **participant rolling outage plan**, by notice in writing to the **specified participant** who submitted the plan,—
 - (a) approve it; or
 - (b) decline to approve it.
- (2) The **system operator** may decline to approve the plan only if the **system operator** is not satisfied that the plan complies with clause 9.8.

Compare: SR 2008/252 r 8D

9.10 Revision of participant rolling outage plans

If the **system operator** declines to approve a **participant rolling outage plan**,—

- (a) the **system operator** must—
 - (i) indicate the grounds on which it declines to approve the plan; and
 - (ii) direct the **specified participant** to submit a revised plan; and
- (b) the **specified participant** must submit a revised plan to the **system operator** no later than—
 - (i) 15 **business days** after the date on which the **specified participant** received the direction from the **system operator** to submit a revised plan; or
 - (ii) any later date that the **system operator** may allow in any particular case.

Compare: SR 2008/252 r 8E

Clause 9.10(b)(i): amended, on 5 October 2017, by clause 146 of the Electricity Industry Participation Code Amendment (Code Review Programme) 2017.

9.11 Approval of revised participant rolling outage plans

- (1) As soon as practicable after receiving a revised **participant rolling outage plan**, the **system operator** must, by notice in writing to the **specified participant** who submitted the plan,—
 - (a) approve the plan; or
 - (b) decline to approve it.
- (2) If the **system operator** declines to approve the revised plan, clause 9.10 applies.

Compare: SR 2008/252 r 8F

9.12 Publishing of participant rolling outage plans

A **specified participant** must make its **participant rolling outage plan** available to the public, at no cost, on an Internet site maintained by or on behalf of the **specified participant**, at all reasonable times, as soon as practicable after it is approved by the **system operator**.

Compare: SR 2008/252 r 8G

9.13 Specified participants must keep participant rolling outage plans up to date

- (1) Each **specified participant** who has had a **participant rolling outage plan** approved under clauses 9.6 to 9.12 must—
 - (a) keep the plan under review, and (if necessary) amend the plan to take account of any change of circumstances and to ensure that the plan continues to comply with clause 9.8; and
 - (b) as soon as practicable after amending the plan, but in any case no later than 20 **business days** after amending it, submit the plan to the **system operator**.
- (2) Despite subclause (1), not later than 2 years after the date on which a **specified participant's participant rolling outage plan** was last approved, the **specified participant** must resubmit the plan to the **system operator** for approval.
- (3) A plan submitted to the **system operator** under subclause (1)(b) is deemed to be approved by the **system operator** unless, no later than 20 **business days** after the **system operator** receives the plan, the **system operator** advises the **specified participant** who submitted the plan, by notice in writing, that it declines to approve the plan.
- (4) Clauses 9.9 to 9.12 apply to a plan that is submitted or resubmitted or declined under this clause, except as provided in subclause (3).

Compare: SR 2008/252 r 8H

Clause 9.13(1)(b) and (3): amended, on 5 October 2017, by clause 147 of the Electricity Industry Participation Code Amendment (Code Review Programme) 2017.

Subpart 1A—Urgent temporary grid reconfigurations

Heading: inserted, on 16 December 2013, by clause 4 of the Electricity Industry Participation (Urgent Temporary Grid Reconfiguration) Code Amendment 2013.

9.13A Purpose

The purpose of this subpart is to provide for the urgent temporary removal of **interconnection assets** from service, or temporary reconfiguration of the **grid**, in order to improve security of **supply**.

Clause 9.13A: inserted, on 16 December 2013, by clause 4 of the Electricity Industry Participation (Urgent Temporary Grid Reconfiguration) Code Amendment 2013.

9.13B Request for urgent temporary grid reconfiguration

- (1) The **system operator** may give notice in writing to **Transpower** requesting that **Transpower** temporarily remove 1 or more **interconnection assets** from service, or temporarily reconfigure the **grid**, if the **system operator** considers that—
 - (a) exceptional circumstances exist—
 - (i) that are likely to lead, for a period of at least 3 weeks, to—
 - (A) a shortfall in thermal fuel; or
 - (B) a shortfall of hydro inflows; or
 - (C) the loss of a large generating **asset**; and
 - (ii) that make it necessary or desirable in the public interest to temporarily remove 1 or more **interconnection assets** from service or temporarily reconfigure the **grid**; and
 - (b) the removal or reconfiguration would improve security of **supply**.
- (2) A notice given under subclause (1) must specify—
 - (a) the exceptional circumstances; and
 - (b) the reasons why temporarily removing **assets** from service or temporarily reconfiguring the **grid** would improve security of **supply**.
- (3) No later than 10 **business days** after giving notice to **Transpower**, the **system operator** must give a written report to the **Authority** setting out the basis on which the **system operator** requested that **Transpower** remove 1 or more **interconnection assets** from service or temporarily reconfigure the **grid**.
- (4) The **system operator** must ensure that the report given under subclause (3) includes—
 - (a) the matters specified in subclause (2)(a) and (b); and
 - (b) sufficient information to demonstrate that in developing its request to **Transpower** the **system operator** followed a robust process, including the options the **system operator** considered and the extent of any analysis and consultation undertaken by the **system operator**.
- (5) The **Authority** must **publish** the report.

Clause 9.13B: inserted, on 16 December 2013, by clause 4 of the Electricity Industry Participation (Urgent Temporary Grid Reconfiguration) Code Amendment 2013.

Clause 9.13B(5): amended, on 5 October 2017, by clause 148 of the Electricity Industry Participation Code Amendment (Code Review Programme) 2017.

Subpart 2—Outages in shortage of supply situation

9.14 Supply shortage declaration

- (1) The **system operator** may, after consultation with the **Authority**, make a **supply shortage declaration**.
- (2) The **system operator** may make a **supply shortage declaration** only if there is a shortage of **electricity** supply or transmission capacity such that the **system operator** considers—

- (a) that the normal operation of the spot market for **electricity** is, or will soon be, unlikely to facilitate the adjustment of supply and demand necessary to ensure that supply matches demand; and
 - (b) that, if planned outages are not implemented, unplanned outages are likely.
- (2A) For the purposes of subclause (2), the spot market for **electricity** includes the processes for setting—
- (a) *[Revoked]*
 - (b) **forecast prices** and **forecast reserve prices**:
 - (c) *[Revoked]*
 - (d) **interim prices** and **interim reserve prices**:
 - (e) **final prices** and **final reserve prices**:
 - (f) **dispatch prices** and **dispatch reserve prices**.
- (3) A declaration applies to—
- (a) all of New Zealand; or
 - (b) the regions specified in the declaration.
- (4) In making a declaration under subclause (1), the **system operator** must have regard to the **system operator rolling outage plan**.
- (5) The **system operator** must **publish** the declaration as soon as practicable after it is made.

Compare: SR 2008/252 r 9

Clause 9.14(2)(a): amended, on 18 July 2013, by clause 8(1) of the Electricity Industry Participation (Undesirable Trading Situation) Code Amendment 2013.

Clause 9.14(2A): inserted, on 18 July 2013, by clause 8(2) of the Electricity Industry Participation (Undesirable Trading Situation) Code Amendment 2013.

Clause 9.14(2A)(a) and (c): revoked, on 1 November 2022, by clause 10(a) of the Electricity Industry Participation Code Amendment (Real Time Pricing) 2022.

Clause 9.14(2A)(f): inserted, on 1 November 2022, by clause 10(b) of the Electricity Industry Participation Code Amendment (Real Time Pricing) 2022.

9.15 Power to direct outages in security of supply situation

- (1) The **system operator** may, at any time in the period during which a **supply shortage declaration** is in force, give a written direction to **specified participants** to contribute to achieving reductions in the consumption of **electricity** by implementing outages or taking any other action specified in the direction.
- (2) A direction must—
 - (a) be consistent with the **system operator rolling outage plan**; and
 - (b) be given only after consultation with the **Authority**; and
 - (c) if the direction requires a **specified participant** to implement outages, specify the savings targets that the **specified participant** must achieve.
- (3) *[Revoked]*
- (4) The **system operator** must **publish** each direction as soon as practicable after it is given.
- (5) The **system operator** may—
 - (a) amend a direction; or
 - (b) revoke a direction and, if the **system operator** considers it appropriate, substitute a new direction.

- (6) Subclauses (1) to (4) apply to an amendment to a direction or a substitute direction—
- (a) as if the amendment or substitute direction were the original direction; and
 - (b) with other necessary modifications.

Compare: SR 2008/252 r 10

Clause 9.15(1): amended, on 5 October 2017, by clause 149(1) of the Electricity Industry Participation Code Amendment (Code Review Programme) 2017.

Clause 9.15(3): revoked, on 5 October 2017, by clause 149(2) of the Electricity Industry Participation Code Amendment (Code Review Programme) 2017.

Clause 9.15(4): amended, on 5 October 2017, by clause 149(3) of the Electricity Industry Participation Code Amendment (Code Review Programme) 2017.

9.16 Specified participants must comply with direction

- (1) Each **specified participant** must comply with a direction given to it by the **system operator** under clause 9.15.
- (2) Each **specified participant** must, in complying with the direction, apply, to the extent practicable, the criteria, methodologies, and principles specified in the **system operator rolling outage plan**.
- (3) Each **specified participant** must comply with a direction in accordance with its **participant rolling outage plan**, if it has a plan that has been approved under subpart 1.
- (4) If a **specified participant** does not have a **participant rolling outage plan** approved under subpart 1, the **specified participant**,—
 - (a) in complying with the direction, must apply, to the extent practicable, the criteria, methodologies, and principles specified in the **system operator rolling outage plan**; and
 - (b) as soon as practicable after the direction is given, must provide to the **system operator** information as to the steps the **specified participant** will take to comply with the direction (including any steps the **specified participant** has already taken to comply with the direction).

Compare: SR 2008/252 r 11

9.17 Revocation of supply shortage declaration

- (1) The **system operator** must revoke a **supply shortage declaration** when it is satisfied that the circumstances that gave rise to the declaration no longer apply.
- (2) The **system operator** must **publish** the revocation as soon as practicable after it is made.

Compare: SR 2008/252 r 13

Subpart 3—Miscellaneous

9.18 Provision of information

- (1) The **system operator** may, by notice in writing to a **participant** who the **system operator** considers may have information relevant to any of the following, require the **participant** to provide the information to the **system operator**:
 - (a) the preparation by the **system operator** of the **system operator rolling outage plan** under clauses 9.1 to 9.5; and
 - (b) the need for a **supply shortage declaration**; and
 - (c) the need for a direction requiring outages under clause 9.15; and

- (d) the number and extent of outages necessary under a direction; and
- (e) monitoring compliance with a direction given under clause 9.15.
- (2) Subclause (1) applies only to information that is—
 - (a) reasonably necessary for the **system operator** to undertake its functions under this Part or to monitor compliance with a direction regarding outages; and
 - (b) in that **participant's** possession or that the **participant** can obtain without unreasonable difficulty or expense.
- (3) The **system operator** must specify in the notice given under subclause (1) the date by which the **participant** must provide the information required.
- (4) A **participant** who has received a notice under subclause (1) must provide the information required by the **system operator** by the date specified by the **system operator** in the notice.
- (5) The **system operator** may require **specified participants** to provide to the **system operator** contact information specified by the **system operator** that would enable the **system operator** to communicate with the **specified participants**.

Compare: SR 2008/252 r 14

Subpart 4—Customer compensation schemes

Subpart 4: inserted, on 1 April 2011, by clause 5 of the Electricity Industry Participation (Customer Compensation Schemes) Code Amendment 2011.

9.19 Contents of this subpart

This subpart provides a framework under which each **retailer** must have a **customer compensation scheme** for all of the **retailer's qualifying customers**, including—

- (a) a **default customer compensation scheme** that a **retailer** must have; and
- (b) **additional customer compensation schemes** that a **retailer** may have; and
- (c) determining when an **official conservation campaign** commences and ends, during which a **retailer** must make payments under its **customer compensation schemes**; and
- (d) a process by which the **Authority** can require that a **retailer's** compliance with this subpart is **audited**.

Clause 9.19: inserted, on 1 April 2011, by clause 5 of the Electricity Industry Participation (Customer Compensation Schemes) Code Amendment 2011.

Clause 9.19(c): amended, on 20 December 2021, by clause 20 of the Electricity Industry Participation Code Amendment (Code Review Programme) 2019.

Requirement for retailers to have customer compensation scheme

9.20 Retailer must have customer compensation scheme

- (1) Each **retailer** who has 1 or more **qualifying customers**—
 - (a) must, at all times, have a **default customer compensation scheme**; and
 - (b) may, in addition to a **default customer compensation scheme**, have 1 or more **additional customer compensation schemes**.
- (2) Each of a **retailer's qualifying customers** must be covered by the **retailer's default customer compensation scheme**, unless the **retailer's qualifying customer** has

elected to be covered by 1 of the **retailer's additional customer compensation schemes** (if any) in accordance with clause 9.27.

- (3) A **retailer's customer compensation scheme** may cover a customer of the **retailer** who is not a **qualifying customer**.

Clause 9.20: inserted, on 1 April 2011, by clause 5 of the Electricity Industry Participation (Customer Compensation Schemes) Code Amendment 2011.

Clause 9.20(2): amended, on 1 November 2018, by clause 17(1) of the Electricity Industry Participation Code Amendment (Code Review Programme) 2018.

Clause 9.20(3): amended, on 1 November 2018, by clause 17(2) of the Electricity Industry Participation Code Amendment (Code Review Programme) 2018.

9.21 Qualifying customers

- (1) A **retailer's qualifying customer** is a person who, at any time during an **official conservation campaign**, —
- (a) is a customer of the **retailer**; and
 - (b) has a contract with the **retailer** for the supply of **electricity** in respect of an **ICP** at which—
 - (i) there is a **category 1 metering installation** or a **category 2 metering installation**; and
 - (ii) there was consumption, in the 12 months immediately before the start of the **official conservation campaign**, of 3000 kWh or more.
- (2) Despite subclause (1), a person is not a **qualifying customer** if the price of all of the **electricity** provided under the person's contract with the **retailer** for the supply of **electricity** is determined by reference to the **final price** at a **GXP**.
- (3) For the purposes of subclause (1)(b)(ii), if a **qualifying customer's** consumption at the **ICP** in the 12 months immediately before the start of the **official conservation campaign** is not available to the **retailer**, the **retailer** must make a reasonable estimate of the consumption.
- (4) To avoid doubt, the retailer is not required to make payments under a **customer compensation scheme** to a **qualifying customer** at an **ICP** in respect of any period during an **official conservation campaign**, when—
- (a) the premises to which the **ICP** is **electrically connected** are vacant; or
 - (b) the **ICP** is **electrically disconnected**.

Clause 9.21: inserted, on 1 April 2011, by clause 5 of the Electricity Industry Participation (Customer Compensation Schemes) Code Amendment 2011.

Clause 9.21: amended, on 5 October 2017, by clause 150(1) of the Electricity Industry Participation Code Amendment (Code Review Programme) 2017.

Clause 9.21(1): amended, on 28 June 2018, by clause 4(1) of the Electricity Industry Participation Code Amendment (Customer Compensation Scheme) 2018.

Clause 9.21(1): amended, on 20 December 2021, by clause 21(1) of the Electricity Industry Participation Code Amendment (Code Review Programme) 2019.

Clause 9.21(1)(a): amended, on 1 November 2018, by clause 18 of the Electricity Industry Participation Code Amendment (Code Review Programme) 2018.

Clause 9.21(1)(b)(i): amended, on 1 December 2011, by clause 6 of the Electricity Industry Participation Code (Distributor Use-of-System Agreements and Distributor Tariffs) Amendment 2011.

Clause 9.21(1)(b)(ii): amended, on 5 October 2017, by clause 150(2) of the Electricity Industry Participation Code Amendment (Code Review Programme) 2017.

Clause 9.21(1)(b)(ii): amended, on 20 December 2021, by clause 21(2) of the Electricity Industry Participation Code Amendment (Code Review Programme) 2019.

Clause 9.21(3): amended, on 5 October 2017, by clause 150(3) of the Electricity Industry Participation Code Amendment (Code Review Programme) 2017.

Clause 9.21(3): amended, on 20 December 2021, by clause 21(3) of the Electricity Industry Participation Code Amendment (Code Review Programme) 2019.

Clause 9.21(4): replaced, on 28 June 2018, by clause 4(2) of the Electricity Industry Participation Code Amendment (Customer Compensation Scheme) 2018.

Clause 9.21(4): amended, on 20 December 2021, by clause 21(4) of the Electricity Industry Participation Code Amendment (Code Review Programme) 2019.

Clause 9.21(4)(a)(i) and (ii): amended, on 5 October 2017, by clause 150(4)(a) and (b) of the Electricity Industry Participation Code Amendment (Code Review Programme) 2017.

Clause 9.21(4)(b)(i): amended, on 5 October 2017, by clause 150(4)(c) of the Electricity Industry Participation Code Amendment (Code Review Programme) 2017.

9.22 Requirement to implement customer compensation schemes

(1) A **retailer** must make payments to its **qualifying customers**, in respect of **ICPs** described in clause 9.21(1)(b), under its **customer compensation schemes** during an **official conservation campaign**.

(2) Despite subclause (1), if the **system operator** has commenced an **official conservation campaign** under clause 9.23(1), a **retailer** must make payments under its **customer compensation scheme** to its **qualifying customers** only in respect of **ICPs**, as described in clause 9.21(1)(b), in the South Island.

Clause 9.22: inserted, on 1 April 2011, by clause 5 of the Electricity Industry Participation (Customer Compensation Schemes) Code Amendment 2011.

Clause 9.22(1) & (2): amended, on 20 December 2021, by clause 22(1) & (2) of the Electricity Industry Participation Code Amendment (Code Review Programme) 2019.

Clause 9.22(2): amended, on 21 September 2012, by clause 12 of the Electricity Industry Participation (Minor Amendments) Code Amendment 2012.

Official conservation campaign

9.23 System operator commences official conservation campaign

(1) The **system operator** must commence an **official conservation campaign** for the South Island—

(a) when a comparison of storage in the South Island hydro lakes with the South Island electricity risk curves, as that term is defined in the **security of supply forecasting and information policy**,—

(i) shows a risk of shortage for the South Island of 10% or more; and

(ii) forecasts that the risk of shortage for the South Island will be 10% or more for 1 week or more; or

(ab) when hydro storage in the South Island hydro lakes is, and the **system operator** forecasts will remain for 1 week or more, equal to or less than—

(i) that part of available hydro storage in the South Island hydro lakes that, as **published** by the **system operator** under the **security of supply forecasting and information policy**, may only be used during an **official conservation campaign**; plus

(ii) the buffer, as that term is defined in the **security of supply forecasting and information policy**; or

(b) despite paragraphs (a) and (ab), if it has agreed a date with the **Authority** for an **official conservation campaign** to commence for the South Island, on that date.

(2) The **system operator** must commence an **official conservation campaign** for New Zealand—

- (a) when a comparison of storage in New Zealand’s hydro lakes with the electricity risk curves, as that term is defined in the **security of supply forecasting and information policy**,—
- (i) shows a risk of shortage for New Zealand of 10% or more; and
 - (ii) forecasts that the risk of shortage for New Zealand will be 10% or more for 1 week or more; or
- (ab) when hydro storage in the New Zealand hydro lakes is, and the **system operator** forecasts will remain for 1 week or more, equal to or less than—
- (i) that part of available hydro storage in the New Zealand hydro lakes that, as **published** by the **system operator** under the **security of supply forecasting and information policy**, may only be used during an **official conservation campaign**; plus
 - (ii) the buffer, as that term is defined in the **security of supply forecasting and information policy**; or
- (b) despite paragraphs (a) and (ab), if it has agreed a date with the **Authority** for an **official conservation campaign** to commence for New Zealand, on that date.
- (3) The **system operator** must use reasonable endeavours to give each **participant** and the **Authority** at least 2 weeks’ notice of an **official conservation campaign** commencing.
- (4) During the period of an **official conservation campaign**, the **system operator** must regularly review the steps that it must take, and encourage **participants** to take, under the **emergency management policy**.
- (5) If the **system operator** and the **Authority** agree under subclause (1)(b) or (2)(b) that an **official conservation campaign** will commence, the **system operator** must **publish** the reasons for agreeing that the **official conservation campaign** will commence.
- (6) *[Revoked]*
- Clause 9.23: inserted, on 1 April 2011, by clause 5 of the Electricity Industry Participation (Customer Compensation Schemes) Code Amendment 2011.
- Clause 9.23(4)(b)(i): amended, on 21 September 2012, by clause 13 of the Electricity Industry Participation (Minor Amendments) Code Amendment 2012.
- Clause 9.23(5): amended, on 5 October 2017, by clause 151 of the Electricity Industry Participation Code Amendment (Code Review Programme) 2017.
- Clause 9.23(1)(a): amended, on 1 August 2019, by clause 4(1) of the Electricity Industry Participation Code Amendment (Official Conservation Campaign) 2019.
- Clause 9.23(1)(ab): inserted, on 1 August 2019, by clause 4(2) of the Electricity Industry Participation Code Amendment (Official Conservation Campaign) 2019.
- Clause 9.23(1)(b): amended, on 1 August 2019, by clause 4(3) of the Electricity Industry Participation Code Amendment (Official Conservation Campaign) 2019.
- Clause 9.23(2)(a): amended, on 1 August 2019, by clause 4(4) of the Electricity Industry Participation Code Amendment (Official Conservation Campaign) 2019.
- Clause 9.23(2)(ab): inserted, on 1 August 2019, by clause 4(5) of the Electricity Industry Participation Code Amendment (Official Conservation Campaign) 2019.
- Clause 9.23(2)(b): amended, on 1 August 2019, by clause 4(6) of the Electricity Industry Participation Code Amendment (Official Conservation Campaign) 2019.
- Clause 9.23(4): replaced, on 1 August 2019, by clause 4(7) of the Electricity Industry Participation Code Amendment (Official Conservation Campaign) 2019.
- Clause 9.23(6): revoked, on 1 August 2019, by clause 4(8) of the Electricity Industry Participation Code Amendment (Official Conservation Campaign) 2019.

9.23A System operator ends official conservation campaign

- (1) If the **system operator** has commenced an **official conservation campaign** under clause 9.23, it must end the **official conservation campaign**—

- (a) for an **official conservation campaign** for the South Island—
 - (i) when a comparison of hydro storage in the South Island hydro lakes with the South Island electricity risk curves, as that term is defined in the **security of supply forecasting and information policy**, shows a risk of shortage for the South Island of less than 8%; and
 - (ii) the amount of hydro storage in the South Island hydro lakes is greater than the amount of hydro storage determined under subparagraphs (i) and (ii) of clause 9.23(1)(ab); or
 - (b) for an **official conservation campaign** for New Zealand—
 - (i) when a comparison of hydro storage in the New Zealand hydro lakes with the New Zealand electricity risk curves, as that term is defined in the **security of supply forecasting and information policy**, shows a risk of shortage for New Zealand of less than 8%; and
 - (ii) the amount of hydro storage in the New Zealand hydro lakes is greater than the amount of hydro storage determined under subparagraphs (i) and (ii) of clause 9.23(2)(ab); or
 - (c) despite paragraphs (a) and (b), if it has agreed a date with the **Authority** for an **official conservation campaign** to end, on that date.
- (2) The **system operator** must, as soon as practicable after ending an **official conservation campaign**, give notice to each **participant** and the **Authority** of the date on which the **official conservation campaign** ended.

Clause 9.23A: inserted, on 1 August 2019, by clause 5 of the Electricity Industry Participation Code Amendment (Official Conservation Campaign) 2019.

Default customer compensation scheme

9.24 Requirements of default customer compensation schemes

- (1) A **retailer's default customer compensation scheme** must provide for the **retailer**—
 - (a) during an **official conservation campaign** for the South Island, to pay each of its **qualifying customers** in the South Island at least the minimum weekly amount of compensation determined by the **Authority** under clause 9.25, at a pro rata daily rate for each day of the **official conservation campaign** that the **qualifying customer** is the **retailer's** customer; and
 - (b) at any other time during an **official conservation campaign**, to pay each of its **qualifying customers** at least the minimum weekly amount of compensation determined by the **Authority** under clause 9.25, at a pro rata daily rate for each day of the **official conservation campaign** that the **qualifying customer** is the **retailer's** customer; and
 - (c) to pay at least the minimum weekly amount, at a pro rata daily rate, for each day of an **official conservation campaign** that the **qualifying customer** is the **retailer's** customer—
 - (i) to each of its **qualifying customers** in the South Island or New Zealand (as the case may be), for each of the **qualifying customer's ICPs** described in clause 9.21(1)(b):

- (ii) no later than the end of 2 **billing periods** after the last day of an **official conservation campaign**.
 - (2) *[Revoked]*
 - (3) For the purposes of this clause—
 - (a) compensation includes—
 - (i) money;
 - (ii) a credit on the **qualifying customer's electricity** account with the **retailer**; and
 - (b) the form of the compensation is to be determined by the **retailer**.
- Clause 9.24: inserted, on 1 April 2011, by clause 5 of the Electricity Industry Participation (Customer Compensation Schemes) Code Amendment 2011.
- Clause 9.24(1)(a): amended, on 28 June 2018, by clause 5(1) of the Electricity Industry Participation Code Amendment (Customer Compensation Scheme) 2018.
- Clause 9.24(1)(b): amended, on 28 June 2018, by clause 5(2) of the Electricity Industry Participation Code Amendment (Customer Compensation Scheme) 2018.
- Clause 9.24(1)(a), (b), (c) & (c)(2): amended, on 20 December 2021, by clause 23(1) to (4) of the Electricity Industry Participation Code Amendment (Code Review Programme) 2019.
- Clause 9.24(1)(c): amended, on 28 June 2018, by clause 5(3) of the Electricity Industry Participation Code Amendment (Customer Compensation Scheme) 2018.
- Clause 9.24(1)(c)(ii): amended, on 5 October 2017, by clause 152 of the Electricity Industry Participation Code Amendment (Code Review Programme) 2017.
- Clause 9.24(2): revoked, on 28 June 2018, by clause 5(4) of the Electricity Industry Participation Code Amendment (Customer Compensation Scheme) 2018.

Minimum weekly amount of compensation

9.25 Authority must determine minimum weekly amount

- (1) In determining the minimum weekly amount that each **retailer** must pay to its **qualifying customers**, the **Authority** must take into account—
 - (a) the estimated value, in dollars/MWh, of the savings that the **Authority** expects all **qualifying customers** in the South Island or New Zealand, as the case may be, of all **retailers**, will achieve during an **official conservation campaign**; and
 - (b) any other factors that the **Authority** considers relevant.
- (2) The **Authority** must—
 - (a) **publish** the minimum weekly amount; and
 - (b) review the minimum weekly amount—
 - (i) after each **official conservation campaign** ends; and
 - (ii) at least once every 3 years; and
 - (c) following a review under paragraph (b), ensure that it gives **participants** at least 3 months' notice if it determines a new minimum weekly amount.

Clause 9.25: inserted, on 1 April 2011, by clause 5 of the Electricity Industry Participation (Customer Compensation Schemes) Code Amendment 2011.

Clause 9.25(2)(a): amended, on 5 October 2017, by clause 153(a) of the Electricity Industry Participation Code Amendment (Code Review Programme) 2017.

Clause 9.25(2)(b)(i) amended, on 20 December 2021, by clause 24 of the Electricity Industry Participation Code Amendment (Code Review Programme) 2019.

Clause 9.25(2)(b)(ii): amended, on 5 October 2017, by clause 153(b) of the Electricity Industry Participation Code Amendment (Code Review Programme) 2017.

Additional customer compensation schemes

9.26 Retailer may have additional customer compensation schemes

A **retailer** may have 1 or more **additional customer compensation schemes**.

Clause 9.26: inserted, on 1 April 2011, by clause 5 of the Electricity Industry Participation (Customer Compensation Schemes) Code Amendment 2011.

9.27 Qualifying customer may elect to be covered by additional customer compensation scheme

- (1) If a **retailer** has 1 or more **additional customer compensation schemes**, each of the **retailer's qualifying customers** is covered by—
 - (a) 1 of the **retailer's additional customer compensation schemes** only if the **qualifying customer** elects to be covered by the **additional customer compensation scheme**; or
 - (b) in the absence of an election, the **retailer's default customer compensation scheme**.
- (2) Before accepting a **qualifying customer's** election, a **retailer** must ensure that it informs the **qualifying customer** of—
 - (a) the details of the **additional customer compensation scheme**; and
 - (b) the differences between the **retailer's default customer compensation scheme** and the **additional customer compensation scheme**.
- (3) A **retailer** must keep a record of each **qualifying customer's** election.
- (4) A **qualifying customer's** election must not—
 - (a) be part of the contract between the **qualifying customer** and the **retailer** for the supply of **electricity**; or
 - (b) affect the tariff options that the **retailer** offers to the **qualifying customer**; or
 - (c) be affected by the tariff option in the **qualifying customer's** contract with the **retailer**.

Clause 9.27: inserted, on 1 April 2011, by clause 5 of the Electricity Industry Participation (Customer Compensation Schemes) Code Amendment 2011.

9.28 Publishing description of additional customer compensation schemes

A **retailer** who has 1 or more **additional customer compensation schemes** must—

- (a) **publish** and keep **published** a description of its **additional customer compensation schemes**; and
- (b) on request from one of the **retailer's** customers, provide a written description of the **additional customer compensation schemes**.

Clause 9.28: inserted, on 1 April 2011, by clause 5 of the Electricity Industry Participation (Customer Compensation Schemes) Code Amendment 2011.

Clause 9.28(a): amended, on 5 October 2017, by clause 154 of the Electricity Industry Participation Code Amendment (Code Review Programme) 2017.

Clause 9.28(b): amended, on 1 November 2018, by clause 19 of the Electricity Industry Participation Code Amendment (Code Review Programme) 2018.

Certification of compliance

Cross heading: replaced, on 5 October 2017, by clause 155 of the Electricity Industry Participation Code Amendment (Code Review Programme) 2017.

9.29 Each retailer must provide certification

- (1) Each **retailer** must certify to the **Authority** that—
 - (a) the **retailer's customer compensation scheme** complies with this subpart; and
 - (b) the **retailer** has provided compensation to its **qualifying customers**, to the extent required by this subpart.
- (2) The certification provided under subclause (1) must be—
 - (a) *[Revoked]*
 - (b) in the form specified by the **Authority**; and
 - (c) signed and dated by a director of the **retailer** and either—
 - (i) another director of the **retailer**; or
 - (ii) the **retailer's** chief financial officer, or a person holding an equivalent position; or
 - (iii) the **retailer's** chief executive officer, or a person holding an equivalent position.
- (3) A **retailer** must provide certifications as follows:
 - (a) within 7 months of the end of an **official conservation campaign**;
 - (b) within 1 month of receiving a request to do so by the **Authority**.
- (4) *[Revoked]*

Clause 9.29: inserted, on 1 April 2011, by clause 5 of the Electricity Industry Participation (Customer Compensation Schemes) Code Amendment 2011.

Heading: amended, on 5 October 2017, by clause 156(1) of the Electricity Industry Participation Code Amendment (Code Review Programme) 2017.

Clause 9.29(1): amended, on 5 October 2017, by clause 156(2) of the Electricity Industry Participation Code Amendment (Code Review Programme) 2017.

Clause 9.29(2): amended, on 5 October 2017, by clause 156(3) of the Electricity Industry Participation Code Amendment (Code Review Programme) 2017.

Clause 9.29(3): amended, on 5 October 2017, by clause 156(4) of the Electricity Industry Participation Code Amendment (Code Review Programme) 2017.

Clause 9.29(3)(a) amended, on 20 December 2021, by clause 25 of the Electricity Industry Participation Code Amendment (Code Review Programme) 2019.

Clause 9.29(4): revoked, on 5 October 2017, by clause 156(5) of the Electricity Industry Participation Code Amendment (Code Review Programme) 2017.

Audit

9.30 Audit of compliance

- (1) The **Authority** may, in its discretion, carry out an **audit** to determine whether a **retailer** has complied with this subpart.
- (2) If the **Authority** decides to **audit** a **retailer** under subclause (1), the **Authority** must require the **retailer** to nominate an appropriate **auditor**.
- (3) The **retailer** must nominate an **auditor** within a reasonable timeframe, and the **Authority** must appoint the nominated **auditor**.
- (4) If the **retailer** fails to nominate an appropriate **auditor** within a reasonable timeframe, the **Authority** may appoint an **auditor** of its own choice.

Clause 9.30: inserted, on 1 April 2011, by clause 5 of the Electricity Industry Participation (Customer Compensation Schemes) Code Amendment 2011.

9.31 Retailer must provide information to auditor

- (1) A **retailer** subject to an **audit** under this subpart must, on request from the **auditor**, provide the **auditor** with information relating to its compliance with this subpart in the previous 12 months or such other period specified by the **auditor**.
- (2) The **retailer** must provide the information within 20 **business days** after receiving a request from the **auditor**.

Clause 9.31: inserted, on 1 April 2011, by clause 5 of the Electricity Industry Participation (Customer Compensation Schemes) Code Amendment 2011.

9.32 Auditor must provide audit report

- (1) The **retailer** must ensure that the **auditor** provides the **Authority** with an **audit** report on the **retailer's** compliance with this subpart that has been prepared in accordance with this clause.
- (2) The **audit** report must include any comments from the **retailer** on any non-compliance found by the **auditor** if the **retailer** provided the comments to the **auditor** within a time specified by the **auditor**.
- (3) *[Revoked]*
- (4) The **audit** report must not contain any of the information provided by the **retailer** to the **auditor** under clause 9.31 unless requested by the **Authority**.

Clause 9.32: inserted, on 1 April 2011, by clause 5 of the Electricity Industry Participation (Customer Compensation Schemes) Code Amendment 2011.

Clause 9.32(1): amended, on 1 February 2016, by clause 24(1) of the Electricity Industry Participation Code Amendment (Code Review Programme) 2015.

Clause 9.32(2): substituted, on 1 February 2016, by clause 24(2) of the Electricity Industry Participation Code Amendment (Code Review Programme) 2015.

Clause 9.32(3): revoked, on 1 February 2016, by clause 24(3) of the Electricity Industry Participation Code Amendment (Code Review Programme) 2015.

Clause 9.32(4): amended, on 1 February 2016, by clause 24(4) of the Electricity Industry Participation Code Amendment (Code Review Programme) 2015.

9.33 Payment of auditor's costs

- (1) If an **audit** establishes, to the **Authority's** reasonable satisfaction, that a **retailer** has not complied with this subpart (whether or not the **Authority** appoints an investigator to investigate the alleged breach), the **retailer** must pay the **auditor's** costs.
- (2) If the **Authority** considers that the **retailer's** non-compliance is minor or relates to some (but not all) of the clauses in this subpart, the **Authority** may, in its discretion, determine the proportion of the **auditor's** costs that the **retailer** must pay, and the **retailer** must pay those costs.
- (3) If an **audit** establishes to the **Authority's** reasonable satisfaction that a **retailer** has complied with this subpart, the **Authority** must pay the **auditor's** costs.

Clause 9.33: inserted, on 1 April 2011, by clause 5 of the Electricity Industry Participation (Customer Compensation Schemes) Code Amendment 2011.

Electricity Industry Participation Code 2010

Part 10 Metering

Contents

- 10.1 Contents of this Part
 - Subpart 1—Preliminary provisions
- 10.2 Authority's discretion and powers
- 10.3 Use of contractors
- 10.4 Participant obligations
- 10.5 References to timing
- 10.6 Participant to provide accurate information
- 10.7 Access to premises in which metering installation located
- 10.8 Requirements for information to be recorded, given, produced, or received
- 10.9 Demarcation of responsibility between metering equipment provider and reconciliation participant
- 10.10 Standards used
 - Metering installations*
- 10.11 Categories of metering installation
- 10.12 Interference with metering installation
- 10.13 Electricity conveyed
- 10.13A Metering installation must record imported electricity separately from exported electricity
 - Unmetered load*
- 10.14 Unmetered load
 - Metering data*
- 10.15 Security of metering data
- 10.16 Metering data exchange timing and formats
 - Audits*
- 10.17 *[Revoked]*
- 10.17A Metering equipment providers and ATHs to arrange for regular audits
- 10.17B Authority and participant requested audits
 - Subpart 2—Ongoing obligations
 - Metering equipment providers*
- 10.18 Category 1 metering installations and higher categories of metering installations must have metering equipment provider
- 10.19 Metering equipment provider
- 10.20 Obligations of metering equipment provider
- 10.21 When metering equipment provider's obligations come into effect
- 10.22 Change of metering equipment provider
- 10.23 Termination of metering equipment provider responsibility
- 10.23A Decommissioning of metering installation at ICP

Responsibility for ensuring there are metering installations

- 10.24 Responsibility for ensuring there is metering installation for ICP that is not also NSP
- 10.25 Responsibility for ensuring there is metering installation for NSP that is not point of connection to grid
- 10.26 Responsibility for ensuring there is metering installation for point of connection to grid
- 10.27 Change in responsibility for ensuring metering installation for point of connection to grid

Connecting and electrically connecting points of connection

- 10.28 *[Revoked]*
- 10.29 When grid owner may connect point of connection to grid
- 10.29A When grid owner may temporarily electrically connect point of connection to grid
- 10.29B Grid owner may electrically connect point of connection to grid

Disconnecting and electrically disconnecting points of connection to the grid

- 10.29C Grid owner may electrically disconnect or disconnect point of connection to grid
- 10.30 When local network owner or embedded network owner may connect NSP that is not point of connection to grid
- 10.30A When local network owner or embedded network owner may temporarily electrically connect NSP that is not point of connection to grid
- 10.30B When distributor may electrically connect NSP that is not point of connection to grid

Disconnecting and electrically disconnecting NSPs

- 10.30C Distributor may electrically disconnect or disconnect NSP that is not point of connection to grid
- 10.31 When distributor may connect ICP that is not NSP
- 10.31A When distributor may temporarily electrically connect ICP that is not NSP
- 10.31B When distributor may electrically connect ICP that is not NSP

Disconnecting and electrically disconnecting ICPs

- 10.31C Distributor may electrically disconnect or disconnect ICP that is not an NSP
- 10.32 Reconciliation participant requesting connection of point of connection
- 10.33 When trader may temporarily electrically connect a point of connection
- 10.33A When trader may electrically connect point of connection

Disconnecting and electrically disconnecting points of connection

- 10.33B Trader must not disconnect or electrically disconnect ICP for which it is not responsible
- 10.33C When trader may bridge meter at ICP

General metering installation requirements

- 10.34 Installation and modification of metering installations
- 10.35 Physical location of metering installations
- 10.36 Reconciliation participant to have arrangement with metering equipment provider

Active and reactive energy metering

- 10.37 Active and reactive measuring and recording requirements

Certification of metering installations

- 10.38 Certification of metering installations

Metering infrastructure

- 10.39 Responsibility for metering infrastructure integration

Approved test houses and ATHs

- 10.40 General requirements for approval as ATH
- 10.41 Requirements applying to ATHs
- 10.42 ATH's functions and ongoing obligations
 - Metering installations that are inaccurate, defective, or not fit for purpose*
- 10.43 Metering installations that are inaccurate, defective, or not fit for purpose to be investigated
- 10.44 Metering installations that are inaccurate, defective, or not fit for purpose to be tested
- 10.45 Investigation and testing costs
- 10.46 Statement of situation
- 10.46A Timeframe for correcting defects and inaccuracies in metering installation
- 10.47 ATH to keep records of modifications to correct defects and inaccuracies in metering installation
- 10.48 Correction of defects and inaccuracies in raw meter data
 - NSP table*
- 10.49 NSP table
 - Dispute resolution*
- 10.50 Dispute resolution
 - Transitional provisions*
- 10.51 Transitional provisions

Schedule 10.1

Tables

Schedule 10.2

[Revoked]

Schedule 10.3

ATHs – approval, expiry, cancellation, and renewal of approval

Schedule 10.4

ATH ongoing functions and obligations

Requirements for calibration of metering components

Schedule 10.5

[Revoked]

Schedule 10.6

Metering equipment provider ongoing obligations and functions

Schedule 10.7

Metering installation requirements

Metering installation general requirements

Metering installation design reports

Determination of metering installation categories

Certification of metering installation

Statistical sampling recertification

Certification validity periods

Accuracy and error calculation
Installation of metering components in metering installations
Certification of metering components
Inspection requirements
Sealing
Schedule 10.8
Metering component requirements
Meters
Measuring transformers
Control devices
Data storage devices
Wiring
Fuses and circuit breakers
Certification stickers
Onsite calibration and certification

10.1 Contents of this Part

This Part provides for—

- (a) ensuring the accuracy of the clearing and settlement of **electricity** trading in the wholesale **electricity** market by regulating how existing and new **metering installations** are used to accurately measure and record **electricity** conveyed; and
- (b) the responsibility for ensuring a **metering installation** is in place; and
- (c) the responsibility for ensuring the compliance of **metering installations**; and
- (d) the processes and procedures that apply to testing, **calibrating**, and **certifying metering installations**; and
- (e) *[Revoked]*
- (f) the processes and procedures that apply to approving **ATHs**; and
- (g) regulating the data use, handling, storage, and transmission processes associated with **metering installations** and **metering data**; and
- (h) regulating **metering installations** that are used for **electricity** trading; and
- (i) the processes and procedures relating to the **registry** and information for the purposes of Part 15; and
- (j) related matters, processes, and procedures.

Clause 10.1(e): revoked, on 1 June 2017, by clause 5 of the Electricity Industry Participation Code Amendment (Requirements and Processes for Audits) 2016.

Subpart 1—Preliminary provisions

10.2 Authority's discretion and powers

- (1) A clause in this Part that gives the **Authority** a discretion or power—
 - (a) confers an absolute discretion to the **Authority**—
 - (i) taking into account any specific requirements set out in the clause; and

- (ii) observing the principles of natural justice; and
- (b) to approve an application by a person to carry out an activity under this Part, may be exercised by—
 - (i) granting the application; or
 - (ii) declining the application; or
 - (iii) granting the application with any conditions that the **Authority** considers appropriate in the circumstances.
- (2) The **Authority**, when exercising a discretion or power under this Part, must act in a timely manner.
- (3) The **Authority** must give an applicant reasons for its decision if the **Authority**—
 - (a) declines an application for approval to carry out an activity under this Part; or
 - (b) grants an application for approval to carry out an activity under this Part with any conditions that the **Authority** considers appropriate in the circumstances.
- (4) Nothing in this Part limits any of the **Authority's** rights and obligations under the **Act**.
Heading: amended, on 5 October 2017, by clause 157(1) of the Electricity Industry Participation Code Amendment (Code Review Programme) 2017.
Clause 10.2(1), (2) and (3): amended, on 5 October 2017, by clause 157(2) and (3) of the Electricity Industry Participation Code Amendment (Code Review Programme) 2017.

10.3 Use of contractors

- (1) A **participant** may perform its obligations and exercise its rights under this Part by using a contractor.
- (2) A **participant** who uses a contractor to perform the **participant's** obligation under this Part—
 - (a) remains responsible and liable for, and is not released from, the obligation, or any other obligation under this Part; and
 - (b) cannot assert that it is not responsible or liable for the obligation on the ground that the contractor—
 - (i) has done or not done something; or
 - (ii) has failed to meet a relevant standard; and
 - (c) must ensure that the contractor has at least the specified level of skill, expertise, experience, or qualification that the **participant** would be required to have if it were performing the obligation itself.
- (3) If a **participant** is a party to a contract or arrangement containing a provision, or part of a provision, which is inconsistent with this Part, the provision, or part of the provision, has no effect.

10.4 Participant obligations

- (1) If this Part provides that a **participant** must obtain a **consumer's** consent, approval, or authorisation, the **participant** must, if relevant, ensure that the consent, approval, or authorisation extends, for the full term of the contract or arrangement in relation to which the consent, approval, or authorisation is given, to any **participant** who may be expected to rely on that consent, approval, or authorisation to remain in compliance with this Part.
- (2) If a **participant** (**participant A**) incorrectly populates the **registry**, causing another

participant (participant B) to breach an obligation under this Code, and **participant B** relies, in good faith, on the incorrect information in the **registry**, **participant B** has not breached its obligation.

- (3) A **participant** must comply with all applicable enactments.
- (4) A **participant** is, unless it is specified otherwise in this Part, responsible for all costs of its compliance with this Part.
- (5) A reference in this Part to a **participant** knowing, or being or becoming aware of, a fact, includes reference to when a **participant** should have, in the circumstances, known, or been or become aware of, the fact.

Clause 10.4(2): amended, on 5 October 2017, by clause 158 of the Electricity Industry Participation Code Amendment (Code Review Programme) 2017.

10.5 References to timing

- (1) If an event is described in this Part as taking place on, or an obligation becoming effective from, a date, it takes place on, or becomes effective from, the beginning of the first **trading period** on the date, unless specified otherwise.
- (2) If a time period is expressed in this Part as—
 - (a) commencing on a date, it commences at the beginning of the first **trading period** on the date, unless specified otherwise:
 - (b) ending on a date, it ends at the close of the final **trading period** on the date, unless specified otherwise.

10.6 Participant to provide accurate information

- (1) A **participant** must take all practicable steps to ensure that information that it provides under this Part is—
 - (a) complete and accurate:
 - (b) not misleading or deceptive:
 - (c) not likely to mislead or deceive.
- (2) If a **participant** becomes aware that the information the **participant** provided under this Part does not comply with subclause (1)(a) to (c), even if the **participant** has taken all practicable steps to ensure that the information complies, the **participant** must, except if clause 10.43 applies, as soon as practicable provide such further information, or corrected information, as is necessary to ensure that the information complies with subclause (1)(a) to (c).

Clause 10.6(2): substituted, on 19 December 2014, by clause 20 of the Electricity Industry Participation Code Amendment (Minor Code Amendments) (No 3) 2014.

10.7 Access to premises in which metering installation located

- (1) In this clause, access to a **metering installation**—
 - (a) means physical access to the premises in which the **metering installation** is located; but
 - (b) does not include access to the following, which are dealt with in Schedule 10.6:
 - (i) **raw meter data** from the **metering installation**; and
 - (ii) the **metering installation** itself and its **metering components**.
- (2) A **reconciliation participant** must, upon receiving a request from 1 of the following parties, arrange access to a **metering installation** for which it is responsible:

- (a) the **Authority**;
 - (b) an **ATH**;
 - (c) an **auditor**;
 - (d) a **metering equipment provider**;
 - (e) a **gaining metering equipment provider**.
- (3) A party listed in subclause (2) may only request access to the **metering installation** for the purposes of exercising the party's rights and performing the party's obligations under this Code or any relevant regulations in relation to 1 or more of the following:
- (a) the party's **audit** functions;
 - (b) the party's administration functions;
 - (c) the party's testing functions;
 - (d) the provision of **metering components**.
- (4) A **reconciliation participant** who is required to give a party listed in subclause (2) access to a **metering installation** must use its best endeavours to do so—
- (a) in accordance with the authorisation, and any conditions or restrictions contained in the authorisation, referred to in subclause (5); and
 - (b) subject to and to the extent allowed by the authorisation, in a manner and within a timeframe which are appropriate in the circumstances, to enable the party to exercise the party's rights, or perform the party's obligations, that are dependent, either directly or indirectly, on access being given.
- (5) If the **reconciliation participant** referred to in subclause (2) is a **trader** responsible for an **ICP** that—
- (a) has a **consumer**, the **trader** must have obtained the authorisation from the **consumer** to access the **metering installation** before arranging access; or
 - (b) does not have a **consumer**, the **trader** must arrange for access to the **metering installation**.
- (6) The **reconciliation participant** must arrange for the party listed in subclause (2) to be provided with any necessary facilities, codes, keys, or other means to enable the party to obtain access to the **metering installation** by the most practicable means.
- Clause 10.7(3): amended, on 5 October 2017, by clause 159 of the Electricity Industry Participation Code Amendment (Code Review Programme) 2017.
Clause 10.7(3): amended, on 20 December 2021, by clause 26 of the Electricity Industry Participation Code Amendment (Code Review Programme) 2019.

10.8 Requirements for information to be recorded, given, produced, or received

- (1) In this Part, a **participant** who must record, give, produce, or receive information, must do so in accordance with 1 or more of the following requirements **published** or **notified** by the **Authority**:
- (a) requirements providing for particular electronic technology;
 - (b) requirements providing for the use of a particular kind of **data storage device**;
 - (c) requirements providing for the use of a particular kind of electronic **communication**.
- (2) Subpart 3 of Part 4 of the Contract and Commercial Law Act 2017 does not, because of section 218(2)(a) of that Act, apply to this Part.
- (3) The **Authority** must act reasonably when determining the requirements referred to in subclause (1).

Clause 10.8(2): amended, on 1 November 2018, by clause 20(a) and (b) of the Electricity Industry Participation Code Amendment (Code Review Programme) 2018.

10.9 Demarcation of responsibility between metering equipment provider and reconciliation participant

- (1) The demarcation of the responsibility of a **metering equipment provider** under this Part and a **reconciliation participant** under Part 15, is at the **services access interface**.
- (2) A **metering equipment provider** is responsible for providing and maintaining the **services access interface**.
- (3) The **services access interface** for a **metering installation** is—
 - (a) determined by the **ATH certifying the metering installation** under clause 10 of Schedule 10.4; and
 - (b) recorded in the **metering installation certification report** under clause 10 of Schedule 10.4.

10.10 Standards used

In this Part a reference to compliance with a standard, including an AS/NZS or IEC standard, is a reference to—

- (a) the version of the standard existing as at 29 August 2013; or
- (b) any amendment to or replacement of the standard incorporated by the **Authority** in accordance with section 131B of the **Act**; or
- (c) any equivalent standard incorporated by reference in this Code by the **Authority**.

Clause 10.10(a): amended, on 29 August 2013, by clause 11 of the Electricity Industry Participation (Metering Arrangements) Code Amendment 2011, Amendment 2013 (No 2).

Clause 10.10(b): amended, on 1 August 2023, by clause 38(1) of the Electricity Industry Participation Code Amendment (System Operation Documents) 2023.

Clause 10.10(c): amended, on 1 August 2023, by clause 38(2) of the Electricity Industry Participation Code Amendment (System Operation Documents) 2023.

Metering installations

10.11 Categories of metering installation

- (1) An **ATH** must, before it **certifies a metering installation**, determine the category of the **metering installation** by reference to the characteristics of the **metering installation**, in accordance with clauses 5 and 6 of Schedule 10.7.
- (2) A **metering installation** used solely for **unmetered load** is category 0.
- (3) The category of each **metering installation**, other than a category 0 **metering installation**, is for all purposes of this Part—
 - (a) determined by the **ATH certifying the metering installation** under clauses 5 and 6 of Schedule 10.7; and
 - (b) recorded in the **metering installation certification report** under clause 8(4) of Schedule 10.7.

10.12 Interference with metering installation

Subject to clause 48 of Schedule 10.7, a **participant** must not directly or indirectly interfere with a **metering installation** for which it is not the **metering equipment provider**, unless—

- (a) it is instructed or permitted to do so by the **metering equipment provider** responsible for the **metering installation**; or
- (b) the **participant** has an arrangement with the **trader** responsible for the **metering installation** as the **gaining metering equipment provider** who will be responsible for the **metering installation**.

Clause 10.12: amended, on 1 February 2021, by clause 5 of the Electricity Industry Participation Code Amendment (Metering and Related Registry Processes) 2020.

10.13 Electricity conveyed

- (1) A **participant** must use the quantity of **electricity** measured by a **metering installation** for a **point of connection** as the **raw meter data** for the quantity of **electricity** conveyed through the **point of connection**.
- (2) Subclause (1) does not apply to **electricity** that is—
 - (a) estimated in accordance with this Code; or
 - (b) supplied by an **embedded generator** who has given notice to the **reconciliation manager** under clause 15.13.
- (3) A **metering equipment provider** must, for each **point of connection** at which it is the **metering equipment provider**, ensure that all **electricity** conveyed through the **point of connection** is measured by a **metering installation** or **metering installations**, in accordance with this Part.
- (4) Despite subclause (3), a **metering equipment provider** is not required to measure **electricity** conveyed through a **point of connection** if the **electricity** is—
 - (a) **unmetered load**; or
 - (b) supplied by an **embedded generator** who has given notice to the **reconciliation manager** under clause 15.13.

Clause 10.13(2)(b): amended, on 1 November 2018, by clause 21(a) of the Electricity Industry Participation Code Amendment (Code Review Programme) 2018.

Clause 10.13(4)(b): amended, on 1 November 2018, by clause 21(b) of the Electricity Industry Participation Code Amendment (Code Review Programme) 2018.

10.13A Metering installation must record imported electricity separately from exported electricity

- (1) A **metering equipment provider** must, for each **point of connection** at which it is the **metering equipment provider**, ensure that, if a **category 1 metering installation** or **category 2 metering installation** is capable of importing and exporting **electricity**,—
 - (a) the **metering installation** measures and records the imported **electricity** separately from the exported **electricity**; and
 - (b) the **metering installation** measures and records the imported **electricity** and exported **electricity** separately for each connected phase if the **metering installation** contains multiple phases.
- (2) A **metering equipment provider** for a category 3 or higher **metering installation** must ensure that the **metering installation** measures and records the imported **electricity** separately from the exported **electricity**.
- (3) Despite subclauses (1) and (2), if the **metering installation** contains multiple phases, the **metering equipment provider** for the **metering installation**—
 - (a) may aggregate together—
 - (i) the amounts of imported **electricity** recorded on different phases; or

- (ii) the amounts of exported **electricity** recorded on different phases; but
 - (b) must not aggregate together imported and exported **electricity**.
- Clause 10.13A: inserted, on 1 February 2021, by clause 6 of the Electricity Industry Participation Code Amendment (Metering and Related Registry Processes) 2020.

Unmetered load

10.14 Unmetered load

- (1) This clause applies to a **retailer** who is recorded in the **registry** as being responsible for an **ICP**.
- (2) A **retailer**—
 - (a) must quantify any **unmetered load** at the **ICP** in accordance with Parts 11 and 15; and
 - (b) may, subject to subclause (3), only treat load as **unmetered load** if it reasonably expects, in any rolling 12 month period, the load to be not greater than—
 - (i) 3,000 kWh; or
 - (ii) 6,000 kWh if the load is predictable load of a type approved and **published** by the **Authority**.
- (3) Subclause (2)(b) does not apply to **distributed unmetered load** managed in accordance with Part 15.
- (4) If the load during a rolling 12 month period exceeds the applicable limit under subclause (2)(b), the **retailer** breaches this clause from the date on which the limit was, or was calculated or estimated to have been, first exceeded.
- (5) A **retailer** described in subclause (4) must—
 - (a) as soon as reasonably practicable, but no later than 20 **business days** after the limit was calculated or estimated to have been first exceeded, commence corrective measures to ensure that it complies with this Part; and
 - (b) within 20 **business days** of commencing the corrective measures referred to in paragraph (a), complete the corrective measures so that it complies with this Part; and
 - (c) as soon as reasonably practicable, but no later than 10 **business days** after it becomes aware of the limit having been calculated or estimated to have been first exceeded, advise each **participant** who is, or would reasonably be expected to be, affected, of—
 - (i) the date on which the limit was calculated or estimated to have been first exceeded; and
 - (ii) the details of the corrective measures that the **retailer** proposes to take, has taken, or is taking, to reduce the **unmetered load**.

Clause 10.14(5)(c)(ii): amended, on 29 August 2013, by clause 12 of the Electricity Industry Participation (Metering Arrangements) Code Amendment 2011, Amendment 2013 (No 2).

Metering data

10.15 Security of metering data

- (1) This clause applies to—
 - (a) a **participant** who has the right to collect, obtain, use, or store **metering data**;

and

- (b) the **Authority**.
- (2) A person to whom this clause applies must take security measures, as are reasonable in the circumstances, to protect **metering data** against loss or unauthorised access, use, modification, or disclosure.
- (3) Subclause (2) is subject to—
- (a) the person's obligations under any other enactment; and
 - (b) the person being otherwise compelled by law; and
 - (c) any applicable material that the **Authority** incorporates by reference into this Code.

Clause 10.15(3): amended, on 1 August 2023, by clause 39 of the Electricity Industry Participation Code Amendment (System Operation Documents) 2023.

10.16 Metering data exchange timing and formats

- (1) A **participant** (other than a **market operation service provider**) must, if it is under an obligation to provide **metering data** under this Part, provide the **metering data** to the relevant person—
- (a) in the absence of any timeframe specified in this Code, within a reasonable timeframe specified by the **Authority**; and
 - (b) in the format the **Authority** specifies to **participants** from time to time.
- (2) The **Authority** must provide reasonable notice of any changes to the format the **Authority** specifies under subclause (1)(b).
- (3) Despite subclause (1)(b), a **participant** may provide the **metering data** in an alternative format if it has an arrangement with the recipient to use the alternative format.
- (4) Despite subclause (3), the **participant** must be able to comply with any format requirements the **Authority** specifies under subclause (1)(b), within 1 **business day** of ceasing to have an arrangement with the recipient under subclause (3).
- (5) Despite using an alternative format under subclause (3), a **participant** must still comply with all other obligations in this Code.

Clause 10.16(1)(a) amended, on 1 November 2018, by clause 22(a) of the Electricity Industry Participation Code Amendment (Code Review Programme) 2018.

Clause 10.16(1)(b): amended, on 1 November 2018, by clause 22(b) of the Electricity Industry Participation Code Amendment (Code Review Programme) 2018.

Clause 10.16(2) amended, on 1 November 2018, by clause 22(c) of the Electricity Industry Participation Code Amendment (Code Review Programme) 2018.

Clause 10.16(4): amended, on 1 November 2018, by clause 22(d) of the Electricity Industry Participation Code Amendment (Code Review Programme) 2018.

Audits

10.17 [Revoked]

Clause 10.17(1): revoked, on 1 February 2016, by clause 25 of the Electricity Industry Participation Code Amendment (Code Review Programme) 2015.

Clause 10.17(1): inserted, on 1 May 2016, by clause 5(1) of the Electricity Industry Participation Code Amendment (Minor Code Amendments) 2016.

Clause 10.17(2): revoked, on 1 May 2016, by clause 5(2) of the Electricity Industry Participation Code Amendment (Minor Code Amendments) 2016.

Clause 10.17: revoked, on 1 June 2017, by clause 6 of the Electricity Industry Participation Code Amendment (Requirements and Processes for Audits) 2016.

10.17A Metering equipment providers and ATHs to arrange for regular audits

Each **metering equipment provider** and each **ATH** must arrange to be **audited** regularly in accordance with Part 16A in respect of the **metering equipment provider's** or **ATH's** obligations under this Part.

Clause 10.17A: inserted, on 1 June 2017, by clause 7 of the Electricity Industry Participation Code Amendment (Requirements and Processes for Audits) 2016.

10.17B Authority and participant requested audits

- (1) The **Authority** may at any time carry out, or appoint an **auditor** to carry out, an **audit** of a **participant** in respect of the **participant's** obligations under this Part.
- (2) If a **participant** considers that another **participant** may not have complied with this Part, the **participant** may request that the **Authority** carry out, or appoint an **auditor** to carry out, an **audit** of the other **participant**.
- (3) Part 16A applies to an **audit** carried out under this clause.

Clause 10.17B: inserted, on 1 June 2017, by clause 7 of the Electricity Industry Participation Code Amendment (Requirements and Processes for Audits) 2016.

Subpart 2—Ongoing obligations

Metering equipment providers

10.18 Category 1 metering installations and higher categories of metering installations must have metering equipment provider

- (1) A **participant** who is responsible under Part 15 for providing **submission information** to the **reconciliation manager** for a **point of connection** must ensure that, for each **metering installation** for the **point of connection** used for an activity regulated under this Code, there is a **metering equipment provider**.
- (2) A **participant** must not use, and must not permit any person to use, a **category 1 metering installation**, or higher category of **metering installation**, for a **point of connection** for an activity regulated under this Code unless, at the time of such use, there is a **metering equipment provider** for the **metering installation**.
- (3) Despite subclauses (1) and (2), a **point of connection** at which all **electricity** conveyed is **unmetered load**—
 - (a) does not require a **metering equipment provider**; and
 - (b) may be used for an activity regulated under this Code.
- (4) If there is more than 1 **metering installation** for a **point of connection**, the **metering equipment provider** for each **metering installation** must be the same **participant**.

10.19 Metering equipment provider

- (1) The **metering equipment provider** for each existing **category 1 metering installation**, or higher category of **metering installation**, being used on 29 August 2013 for an activity regulated under this Code, for a **point of connection**—
 - (a) that is an **ICP** and not also an **NSP**, is the **participant**, or a **consumer**, who is identified in the **registry** as being the primary metering contact at 2400 hours on 28 August 2013;
 - (b) that is an **NSP** and not also a **point of connection** to the **grid**—
 - (i) is the **participant** who owns the **meter** for the **point of connection**:

- (ii) if there is more than 1 **meter** for the **point of connection**, is the **participant** who is appointed by the **meter** owners for the **point of connection**, or failing agreement, appointed by the **Authority**;
 - (c) to the **grid**, is the **participant** responsible for **metering** as set out in the **NSP** table on the **Authority's** website at 2400 hours on 28 August 2013.
- (2) The **metering equipment provider** for each **category 1 metering installation**, or higher category of **metering installation** for a **point of connection**, other than a **metering installation** referred to in subclause (1),—
 - (a) that is an **ICP** and not also an **NSP**, is the person recorded in the **registry** as accepting responsibility as the **metering equipment provider** under clause 1(1)(a)(ii) of Schedule 11.4;
 - (b) that is an **NSP** and not also a **point of connection** to the **grid**, is—
 - (i) the **network** owner referred to in clause 10.25(2)(a)(i); or
 - (ii) if a person has contracted with the **network** owner under clause 10.25(2)(a)(ii), that person;
 - (c) that is a **point of connection** to the **grid**, is—
 - (i) the **participant** referred to in clause 10.26(7)(b); or
 - (ii) if a person has contracted with the **participant** responsible for providing a **metering installation** under clause 10.26(7)(b), that person.

Clause 10.19(1): amended, on 29 August 2013, by clause 13(1) of the Electricity Industry Participation (Metering Arrangements) Code Amendment 2011, Amendment 2013 (No 2).

Clause 10.19(1)(a): amended, on 29 August 2013, by clause 13(2) of the Electricity Industry Participation (Metering Arrangements) Code Amendment 2011, Amendment 2013 (No 2).

Clause 10.19(1)(b)(ii): amended, on 5 October 2017, by clause 160(a) of the Electricity Industry Participation Code Amendment (Code Review Programme) 2017.

Clause 10.19(1)(c): amended, on 29 August 2013, by clause 13(3) of the Electricity Industry Participation (Metering Arrangements) Code Amendment 2011, Amendment 2013 (No 2).

Clause 10.19(2)(a): amended, on 5 October 2017, by clause 160(b) of the Electricity Industry Participation Code Amendment (Code Review Programme) 2017.

10.20 Obligations of metering equipment provider

A **metering equipment provider** must—

- (a) *[Revoked]*
- (b) comply with all of its obligations in this Code including the obligations under Schedules 10.6, 10.7, and 10.8.

Clause 10.20(a): revoked, on 1 June 2017, by clause 8 of the Electricity Industry Participation Code Amendment (Requirements and Processes for Audits) 2016.

10.21 When metering equipment provider's obligations come into effect

- (1) The obligations under this Part of a person who assumes responsibility, or is appointed to be responsible, as the **metering equipment provider**, under clauses 10.19(2) or 10.22, for a **metering installation**, commence,—
 - (a) for an **ICP** that is not also an **NSP**, on the date that is recorded in the **registry** as being the date on which the **metering installation equipment** was installed; or
 - (b) for an **NSP**, on the effective date set out in the **NSP** table on the **Authority's** website.
- (2) Despite subclause (1), if a person fails to become the **metering equipment provider** due solely to an administrative failure or similar reason, the **Authority** may determine

the date that the person becomes the **metering equipment provider**.

Clause 10.21(1)(a): substituted, on 29 August 2013, by clause 14 of the Electricity Industry Participation (Metering Arrangements) Code Amendment 2011, Amendment 2013 (No 2).

10.22 Change of metering equipment provider

- (1) The **metering equipment provider** for a **metering installation** may change only if the **participant** responsible for ensuring there is a **metering installation** under clause 10.24, 10.25, or 10.26 enters into an arrangement with another person to become the **metering equipment provider** for the **metering installation** and—
 - (a) in the case of a **metering installation** for an **ICP** that is not also an **NSP**—
 - (i) the **trader** for the **metering installation** records the name of the **gaining metering equipment provider** in the **registry** in accordance with Part 11; and
 - (ii) the **gaining metering equipment provider** records in the **registry** that it accepts becoming the **metering equipment provider** (including the effective date from which the **gaining metering equipment provider** assumes its responsibility as **metering equipment provider** for the **metering installation**) in accordance with Part 11; or
 - (b) in the case of a **metering installation** for an **NSP**, the **participant** responsible for the provision of the **metering installation** under clause 10.25 advises the **reconciliation manager** of the **gaining metering equipment provider**.
- (1A) The **losing metering equipment provider** must within 40 **business days** of the **gaining metering equipment provider** assuming responsibility for a **metering installation**—
 - (a) calculate any proportion of costs described in subclauses (3) and (4); and
 - (b) notify the **gaining metering equipment provider** in writing of those costs.
- (1B) The **losing metering equipment provider** does not need to comply with subclause (1A) if the **losing metering equipment provider** does not wish to charge the **gaining metering equipment provider** a proportion of costs.
- (1C) If the **losing metering equipment provider** does not carry out the calculation and notify the **gaining metering equipment provider** under subclause 1(A) within the time frame in that subclause, the **gaining metering equipment provider** does not need to comply with subclause (2).
- (2) The **gaining metering equipment provider** must, within 20 **business days** of receiving a notice provided under subclause (1A), pay the **losing metering equipment provider** the proportion of the costs described in subclause (3) and subclause (4).
- (3) The costs payable under subclause (2) are those directly and solely attributable to the **certification tests** and **calibration tests** of—
 - (a) the **metering installation**; or
 - (b) any **metering components** in the **metering installation**.
- (4) However, when calculating the costs payable under subclause (2)—
 - (a) no costs are payable for a **metering component** in a **metering installation** if the **gaining metering equipment provider**, within three **business days** of assuming responsibility for the **metering installation**,—
 - (i) replaces the **metering component**; or
 - (ii) removes the **metering component** from use; or
 - (iii) **recertifies** the **metering component**; and

- (b) no costs are payable for a **metering installation** if the **gaining metering equipment provider**, within three **business days** of assuming responsibility for the **metering installation**,—
 - (i) replaces the **metering installation**; or
 - (ii) removes the **metering installation** from use; or
 - (iii) **recertifies** the **metering installation**; and
 - (c) the costs for a **metering component** must be prorated for the remainder of the **certification** validity period for the **metering component**; and
 - (d) the costs for a **metering installation** are the sum of the prorated costs payable under this clause for each **metering component** in the **metering installation**.
- (5) Despite subclause (2), a **gaining metering equipment** provider is not required to pay the costs if—
- (a) it has agreed in writing with the **losing metering equipment provider** that the **gaining metering equipment provider** is not required to pay costs under this clause; or
 - (b) the **losing metering equipment provider** has failed to provide notice of the costs to the **gaining metering equipment provider** in accordance with subclause (1A).

Clause 10.22(1)(a)(i) and (ii): amended, on 5 October 2017, by clause 161(a) and (b) of the Electricity Industry Participation Code Amendment (Code Review Programme) 2017.

Clause 10.22(1A), (1B) and (1C): inserted, on 1 February 2021, by clause 7(1) of the Electricity Industry Participation Code Amendment (Metering and Related Registry Processes) 2020.

Clause 10.22(2): amended, on 1 February 2021, by clause 7(2) of the Electricity Industry Participation Code Amendment (Metering and Related Registry Processes) 2020.

Clause 10.22(3): replaced, on 1 February 2021, by clause 7(3) of the Electricity Industry Participation Code Amendment (Metering and Related Registry Processes) 2020.

Clause 10.22(4) and (5): inserted, on 1 February 2021, by clause 7(4) of the Electricity Industry Participation Code Amendment (Metering and Related Registry Processes) 2020.

10.23 Termination of metering equipment provider responsibility

- (1) Subject to subclause (2), a **metering equipment provider's** obligations under this Part for a **metering installation** terminate only when—
- (a) for an **ICP** that is not also an **NSP**, the **metering equipment provider** changes under clause 10.22(1)(a), in which case the **metering equipment provider's** obligations terminate from the date on which the **gaining metering equipment provider** assumes responsibility, set out in clause 10.21(1)(a); or
 - (b) for an **NSP**, the **metering equipment provider** changes under clause 10.22(1)(b), in which case the **metering equipment provider's** obligations terminate from the date on which the **gaining metering equipment provider** assumes responsibility, set out in clause 10.21(1)(b); or
 - (c) the **metering installation** is no longer required for the purposes of Part 15 and the **point of connection** for the **metering installation** has been **decommissioned**; or
 - (d) the **ICP** for the **metering installation** is converted to be used solely for **unmetered load** in accordance with this Code.
- (2) Despite subclause (1), a **metering equipment provider** must either—
- (a) comply with its continuing obligations, including record keeping obligations, which—
 - (i) are expressed in this Part as having minimum time periods, until that period expires; or
 - (ii) by their nature extend beyond the date or event referred to in subclause (1);

or

- (b) before its obligations terminate under subclause (1), enter into an arrangement with a **participant** to assume its obligations referred to in paragraph (a).

10.23A Decommissioning of metering installation at ICP

- (1) If a **metering installation** at an **ICP** is to be **decommissioned**, but the **ICP** is not being **decommissioned**, the **metering equipment provider** that is responsible for **decommissioning** the **metering installation** must,—
 - (a) if the **metering equipment provider** is responsible for **interrogating** the **metering installation**—
 - (i) arrange for a final **interrogation** to take place before the **metering installation** is **decommissioned**; and
 - (ii) provide the **raw meter data** from the **interrogation** to the **trader** that is recorded in the **registry** as being responsible for the **ICP**; or
 - (b) if another **participant** is responsible for **interrogating** the **metering installation**, advise the other **participant** not less than 3 **business days** before the **decommissioning**—
 - (i) of the date and time of the **decommissioning**; and
 - (ii) that the **participant** must carry out a final **interrogation**.
- (2) To avoid doubt, if a **metering installation** at an **ICP** is to be **decommissioned** because the **ICP** is being **decommissioned**—
 - (a) the **metering equipment provider** is not responsible for arranging a final **interrogation** of the **metering installation**; and
 - (b) the **trader** that is recorded in the **registry** as being responsible for the **ICP** must arrange for a final **interrogation** of the **metering installation** under clause 11.18(3).

Clause 10.23(A): inserted, on 1 November 2018, by clause 23 of the Electricity Industry Participation Code Amendment (Code Review Programme) 2018.

Responsibility for ensuring there are metering installations

10.24 Responsibility for ensuring there is metering installation for ICP that is not also NSP

A **trader** must, for each **electrically connected ICP** that is not also an **NSP**, and for which it is recorded in the **registry** as being responsible, ensure that—

- (a) there is 1 or more **metering installations**; and
- (b) all **electricity** conveyed is quantified in accordance with this Code; and
- (c) it does not use subtraction to determine **submission information** for the purposes of Part 15.

Clause 10.24: amended, on 5 October 2017, by clause 162 of the Electricity Industry Participation Code Amendment (Code Review Programme) 2017.

10.25 Responsibility for ensuring there is metering installation for NSP that is not point of connection to grid

- (1) A **distributor** must, for each **NSP** that is not a **point of connection** to the **grid**, and for which it is recorded in the **NSP** table on the **Authority's** website as being responsible, ensure that—
 - (a) there is 1 or more **metering installations**; and

- (b) all **electricity** conveyed is quantified in accordance with this Code:
- (2) A **distributor** must, if it proposes the creation of a new **NSP** that is not a **point of connection** to the **grid**,—
- (a) for each **metering installation** for the **NSP**, either—
- (i) assume responsibility for being the **metering equipment provider**; or
- (ii) contract with a person who, in that contract, assumes responsibility for being the **metering equipment provider**; and
- (b) within 20 **business days** after assuming responsibility or entering into the contract under paragraph (a), advise the **reconciliation manager** of—
- (i) the **reconciliation participant** for the **NSP**;
- (ii) *[Revoked]*
- (c) within 5 **business days** after the date of **certification** of each **metering installation**, advise the **reconciliation manager** of—
- (i) the **participant identifier** of the **metering equipment provider** for the **metering installation**; and
- (ii) the **certification** expiry date of the **metering installation**.
- (3) In relation to an **NSP** of the type described in subclause (1), a **distributor** must, no later than 20 **business days** after a **metering installation** for such an **NSP** is **recertified**, advise the **reconciliation manager** of the following:
- (a) the **reconciliation participant** for the **NSP**;
- (b) the **participant identifier** of the **metering equipment provider** for the **metering installation**;
- (c) the **certification** expiry date of the **metering installation**.

Clause 10.25(1): amended, on 29 August 2013, by clause 15(1) of the Electricity Industry Participation (Metering Arrangements) Code Amendment 2011, Amendment 2013 (No 2).

Clause 10.25(2): amended, on 29 August 2013, by clause 15(2) of the Electricity Industry Participation (Metering Arrangements) Code Amendment 2011, Amendment 2013 (No 2).

Clause 10.25(2)(b)(ii): amended, on 29 August 2013, by clause 15(3) of the Electricity Industry Participation (Metering Arrangements) Code Amendment 2011, Amendment 2013 (No 2).

Clause 10.25(2)(b)(ii): amended, on 1 February 2016, by clause 26(1) of the Electricity Industry Participation Code Amendment (Code Review Programme) 2015.

Clause 10.25(2)(c): amended, on 1 February 2016, by clause 26(2) of the Electricity Industry Participation Code Amendment (Code Review Programme) 2015.

Clause 10.25(3): inserted, on 1 February 2016, by clause 26(3) of the Electricity Industry Participation Code Amendment (Code Review Programme) 2015.

Clause 10.25(2)(b): amended, on 1 February 2021, by clause 8(1)(a) and (b) of the Electricity Industry Participation Code Amendment (Metering and Related Registry Processes) 2020.

Clause 10.25(2)(b)(ii): revoked, on 1 February 2021, by clause 8(1)(c) of the Electricity Industry Participation Code Amendment (Metering and Related Registry Processes) 2020.

Clause 10.25(2)(c): replaced, on 1 February 2021, by clause 8(2) of the Electricity Industry Participation Code Amendment (Metering and Related Registry Processes) 2020.

Clause 10.25(2)(c) and (2)(c)(ii): amended, on 1 March 2024, by clause 36 of the Electricity Industry Participation Code Amendment (Code Review Programme) 2024.

10.26 Responsibility for ensuring there is metering installation for point of connection to grid

- (1) A **grid owner** must, for each **GXP** which connects to its **grid**, ensure that there is 1 or more **certified metering installations** for the **GXP**.
- (2) An **asset owner** must, for each **GIP** which connects to the **grid**, ensure that there is 1 or more **certified metering installations** for the **GIP**.
- (3) A **participant** who proposes to connect to the **grid** at a new **point of connection** must take all practicable steps and use its best endeavours to agree with the **grid owner** and

- any other affected **participants**, on which **participant** will provide the **metering installation** for the proposed new **point of connection**.
- (4) If the **participants** cannot agree, within 60 **business days** of the **grid owner** first being advised of the proposed new **point of connection** to the **grid**, on the **participant** to be responsible for providing the **metering installation**,—
- (a) any affected **participant** may advise the **Authority**—
 - (i) that agreement has not been reached; and
 - (ii) of the identity of all affected **participants**; and
 - (iii) of the reasons (if and to the extent known) that agreement was not reached; and
 - (b) the **Authority** must determine which **participant** must provide the **metering installation**; and
 - (c) the **Authority** must advise—
 - (i) the relevant **participant** of its responsibility to provide the **metering installation**; and
 - (ii) the **participant** intending to connect to the **grid** of its determination; and
 - (iii) the **grid owner** of its determination.
- (5) When determining which **participant** is responsible for providing the **metering installation**, the **Authority** must, unless it is satisfied that there is good reason not to do so, do so on the basis that—
- (a) the **grid owner** is responsible if the **Authority** anticipates that the **point of connection** is a **GXP**; and
 - (b) the **participant** connecting **assets** to the **grid** at the **point of connection** is responsible if the **Authority** anticipates that the **point of connection** is a **GIP**.
- (6) The **participant** responsible for providing the **metering installation** (unless the **participant** is a **grid owner**) must also, for each proposed new **metering installation** for a **point of connection** to the **grid**,—
- (a) provide a copy of the **metering installation** design to the **grid owner** before ordering equipment; and
 - (b) provide the **grid owner** with at least 3 months to review and comment on the **metering installation** design; and
 - (c) respond, within 3 **business days** of receipt, to any request from the **grid owner** for additional details or required changes to the **metering installation**; and
 - (d) ensure that any reasonable changes to the **metering installation** or the **metering installation** configuration requested by the **grid owner** are carried out.
- (7) The **participant** responsible for providing the **metering installation** must—
- (a) advise the **reconciliation manager** of the **certification** expiry date of the **metering installation** no later than 10 **business days** after **certification** of the **metering installation**; and
 - (b) assume responsibility for being the **metering equipment provider** for the **metering installation** or contract with a person to assume responsibility for being the **metering equipment provider** for the **metering installation**; and
 - (c) advise the **reconciliation manager** of the **participant identifier** of the **metering equipment provider** under paragraph (b) by no later than 20 **business days** after,—
 - (i) if it is appointed under a contract, entering into the contract under

- paragraph (b); or
- (ii) if it assumes responsibility for being the **metering equipment provider**, other than under a contract, assuming responsibility.
- (8) The **participant** responsible for providing the **metering installation** (unless the **participant** is a **grid owner**) must, in the case of a proposed modification to an existing **metering installation** under clause 19 of Schedule 10.7—
- (a) provide a copy of the **metering installation** design to the **grid owner** before ordering equipment or carrying out the modification to the **metering installation** design; and
- (b) provide the **grid owner** with at least 3 months to review and comment on the **metering installation** design; and
- (c) respond, within 3 **business days** of receipt, to any request from the **grid owner** for additional details or required changes to the **metering installation** or its configuration; and
- (d) ensure that any reasonable changes to the **metering installation** or the **metering installation** configuration requested by the **grid owner** are carried out.
- (9) If the **grid owner** considers, acting reasonably, that a proposed new **metering installation**, or a proposed change to an existing **metering installation**, or its configuration, requires subtraction or a **loss compensation** or **error compensation** process to determine **submission information** for the purposes of Part 15, the **grid owner** must, unless an **error compensation** process is to be applied to the **metering installation** that is already within the applicable accuracy tolerances set out in Table 1 of Schedule 10.1—
- (a) provide all relevant details to the **Authority**, in the **prescribed form**, at least 20 **business days** before—
- (i) the proposed date for installing the **metering installation**; or
- (ii) the proposed date for changing the **metering installation** or **metering installation's** configuration; and
- (b) respond, within 3 **business days** of receipt, to any request from the **Authority** for additional details; and
- (c) ensure that any reasonable changes to the **metering installation** or its configuration requested by the **Authority** are carried out.
- (10) A **metering equipment provider** must ensure that the quantity of **electricity** conveyed through a **point of connection** to the **grid** for which there is a **metering installation** for which it is responsible is measured using a **half-hour metering installation**.
- (11) If a **metering installation** for a **point of connection** to the **grid** is **recertified**, the **participant** responsible for providing the **metering installation** must, within 10 **business days** of the date of **recertification**, advise the **reconciliation manager** of the **metering installation's** new **certification** expiry date.

Clause 10.26(1): amended, on 29 August 2013, by clause 16(1) of the Electricity Industry Participation (Metering Arrangements) Code Amendment 2011, Amendment 2013 (No 2).

Clause 10.26(2): amended, on 29 August 2013, by clause 16(2) of the Electricity Industry Participation (Metering Arrangements) Code Amendment 2011, Amendment 2013 (No 2).

Clause 10.26(3): amended, on 23 February 2015, by clause 75 of the Electricity Industry Participation Code Amendment (Distributed Generation) 2014.

Clause 10.26(4)(c)(ii): amended, on 23 February 2015, by clause 75 of the Electricity Industry Participation Code Amendment (Distributed Generation) 2014.

Clause 10.26(5)(b): amended, on 23 February 2015, by clause 75 of the Electricity Industry Participation Code Amendment (Distributed Generation) 2014.

Clause 10.26(3), (4), (5) and 9: amended, on 5 October 2017, by clause 163 of the Electricity Industry Participation Code Amendment (Code Review Programme) 2017.

10.27 Change in responsibility for ensuring metering installation for point of connection to grid

- (1) If a **participant** considers, on the basis of historical **metering data**, that there has been a change in the overall net flow of **electricity** at a **point of connection** to the **grid** over any 12 month period, the **participant** who is responsible for ensuring there is a **metering installation** may initiate the process under clauses 10.26(3) to 10.26(5) with all necessary amendments, in order to change the **participant** responsible for providing the **metering installation**.
- (2) If the **participant** who is responsible for ensuring there is a **metering installation** changes under subclause (1), the responsibility for providing **submission information** to the **reconciliation manager** under Part 15 changes.

Connecting and electrically connecting points of connection

Heading: amended, on 29 August 2013, by clause 17(1) of the Electricity Industry Participation (Metering Arrangements) Code Amendment 2011, Amendment 2013 (No 2).

Heading: amended, on 5 October 2017, by clause 164 of the Electricity Industry Participation Code Amendment (Code Review Programme) 2017.

10.28 [Revoked]

Clause 10.28: substituted, on 29 August 2013, by clause 17 of the Electricity Industry Participation (Metering Arrangements) Code Amendment 2011, Amendment 2013 (No 2).

Clause 10.28(2)(a), (2)(b) and (3): amended, on 23 February 2015, by clause 75 of the Electricity Industry Participation Code Amendment (Distributed Generation) 2014.

Clause 10.28: revoked, on 5 October 2017, by clause 165 of the Electricity Industry Participation Code Amendment (Code Review Programme) 2017.

10.29 When grid owner may connect point of connection to grid

- (1A) Only a **grid owner** may connect a **point of connection** to the **grid**.
- (1) Despite subclause (1A), a **grid owner** must not connect a **point of connection** to the **grid** unless it has—
 - (a) ensured that the processes described in clause 10.26 have been carried out; and
 - (b) requested, in the **prescribed form**, not less than 20 **business days** before the proposed connection date, authorisation from the **Authority**, to connect the **point of connection**; and
 - (c) obtained the authorisation referred to in paragraph (b) from the **Authority**.
- (2) The **grid owner** must, within 5 **business days** of connecting a **point of connection** to the **grid**, advise the **reconciliation manager** of—
 - (a) the **point of connection** that has been connected; and
 - (b) the connection date.

Heading: amended, on 5 October 2017, by clause 166(1) of the Electricity Industry Participation Code Amendment (Code Review Programme) 2017.

Clause 10.29(1A): inserted, on 5 October 2017, by clause 166(2)(a) of the Electricity Industry Participation Code Amendment (Code Review Programme) 2017.

Clause 10.29(1) and (2): amended, on 5 October 2017, by clause 166(2)(b) to (d) of the Electricity Industry

Participation Code Amendment (Code Review Programme) 2017. Clause 10.29: substituted, on 29 August 2013, by clause 18 of the Electricity Industry Participation (Metering Arrangements) Code Amendment 2011, Amendment 2013 (No 2).

Clause 10.29: amended, on 23 February 2015, by clause 75 of the Electricity Industry Participation Code Amendment (Distributed Generation) 2014.

10.29A When grid owner may temporarily electrically connect point of connection to grid

- (1) Subject to clause 10.33, only a **grid owner** may temporarily electrically connect a **point of connection** to the **grid**.
- (2) A **grid owner** may temporarily electrically connect a **point of connection** to the **grid** that is to be quantified with a **category 1 metering installation**, or higher category of **metering installation**, only if a **metering equipment provider** requests that the **grid owner** temporarily electrically connect the **point of connection** to the **grid** for the purposes of—
 - (a) **certifying a metering installation** at the **point of connection** to the **grid**; or
 - (b) maintaining, repairing, testing, or **commissioning a metering installation** at the **point of connection** to the **grid**.
- (3) Despite subclause (2), a **metering equipment provider** must not request that a **grid owner** temporarily electrically connect a **point of connection** to the **grid** unless—
 - (a) the **grid owner** responsible for the **point of connection** has authorised the **metering equipment provider** to do so; and
 - (b) the **metering equipment provider** has an arrangement with that **grid owner** to provide **metering services**.

Clause 10.29A: inserted, on 5 October 2017, by clause 167 of the Electricity Industry Participation Code Amendment (Code Review Programme) 2017.

10.29B Grid owner may electrically connect point of connection to grid

- (1) Subject to clause 10.33A, only a **grid owner** may electrically connect a **point of connection** to the **grid** that it owns or operates.
- (2) A **grid owner** may only electrically connect a **point of connection** under subclause (1) if—
 - (a) in the case of the **electrical connection** of a **direct consumer** or **grid connected generator**, there is a **trader** identified as responsible under Part 15 for the delivery of **submission information** for the **electricity** conveyed at the **point of connection** from the time of **electrical connection**; or
 - (b) in the case of the **electrical connection** of a **local network** that has one or more **consumers** connected to the **local network** or to an **embedded network** that is connected to the **local network** (either directly or through another **embedded network**), one or more **traders** are identified as responsible under Part 15 for the delivery of **submission information** for the **electricity** conveyed at the **point of connection** from the time of **electrical connection**; or
 - (c) in the case of the **electrical connection** of a **local network** that has no **consumers** connected to the **local network** or to any **embedded network** that is connected to the **local network** (either directly or through another **embedded network**), if the **distributor** for that **local network** is identified as responsible under Part 15 for the delivery of **submission information** for the **electricity** conveyed at the **point of connection** from the time of **electrical connection**.

Clause 10.29B: inserted, on 1 February 2021, by clause 9 of the Electricity Industry Participation Code Amendment

(Metering and Related Registry Processes) 2020.

Disconnecting and electrically disconnecting points of connection to the grid

10.29C Grid owner may electrically disconnect or disconnect point of connection to grid

- (1) Subject to subclause (2), only a **grid owner** may—
 - (a) **electrically disconnect a point of connection to the grid**; or
 - (b) **disconnect a point of connection to the grid**.
- (2) A **grid owner** may disconnect or **electrically disconnect a point of connection to the grid** that it owns or operates only if the action is required for the **grid owner** to meet its obligations—
 - (a) under an enactment, including this Code; or
 - (b) under its contract with the party identified in clause 10.29B(2) as responsible in accordance with Part 15 for the delivery of **submission information** for the **electricity** conveyed at the **point of connection to the grid**.

Clause 10.29C: inserted, on 1 February 2021, by clause 9 of the Electricity Industry Participation Code Amendment (Metering and Related Registry Processes) 2020.

10.30 When local network owner or embedded network owner may connect NSP that is not point of connection to grid

- (1A) Only a **local network** owner that initiates, under Part 11, the creation of an **NSP** on its **local network** that is not a **point of connection to the grid** may connect the **NSP** to—
 - (a) an **embedded network**, but only if the **embedded network** owner has agreed to the connection; or
 - (b) another **local network**, but only if the owner of the other **local network** has agreed to the connection.
- (1B) Only an **embedded network** owner that initiates, under Part 11, the creation of an **NSP** on its **embedded network**—
 - (a) may connect the **NSP** to another **embedded network**; but
 - (b) can only do so if the other **embedded network** owner has agreed to the connection.
- (1) A **local network** owner or an **embedded network** owner must not connect an **NSP** on its **network** under subclause (1A) or (1B) unless requested to do so by the **reconciliation participant** responsible for ensuring there is a **metering installation** for the **NSP**.
- (2) A **local network** owner or an **embedded network** owner that initiates the creation of an **NSP** under Part 11 on the owner's **network** and connects the **NSP** under this clause must, within 5 **business days** of connecting the **NSP**, advise the **reconciliation manager** of the following:
 - (a) that the **NSP** has been connected; and
 - (b) the connection date; and
 - (c) the **participant identifier** of the **metering equipment provider** for each **metering installation** for the **NSP**; and
 - (d) the **certification** expiry date of each **metering installation** for the **NSP**.

Clause 10.30: substituted, on 29 August 2013, by clause 19 of the Electricity Industry Participation (Metering Arrangements) Code Amendment 2011, Amendment 2013 (No 2).

Clause 10.30: amended, on 23 February 2015, by clause 75 of the Electricity Industry Participation Code Amendment (Distributed Generation) 2014.

Clause 10.30: replaced, on 5 October 2017, by clause 168 of the Electricity Industry Participation Code Amendment (Code Review Programme) 2017.

Clause 10.30: replaced, on 1 February 2021, by clause 10 of the Electricity Industry Participation Code Amendment (Metering and Related Registry Processes) 2020.

10.30A When local network owner or embedded network owner may temporarily electrically connect NSP that is not point of connection to grid

- (1) Subject to clause 10.33, only a **local network** owner that initiates, under Part 11, the creation of an **NSP** on its **local network** that is not a **point of connection** to the **grid** may temporarily **electrically connect** the **NSP** to—
 - (a) an **embedded network**, but only if the **embedded network** owner has agreed to the temporary **electrical connection**; or
 - (b) another **local network**, but only if the owner of the other **local network** has agreed to the temporary **electrical connection**.
- (2) Subject to clause 10.33, only an **embedded network** owner that initiates, under Part 11, the creation of an **NSP** on its **embedded network**—
 - (a) may temporarily **electrically connect** the **NSP** to another **embedded network**; but
 - (b) can only do so if the other **embedded network** owner has agreed to the temporary **electrical connection**.
- (3) A **local network** owner or an **embedded network** owner may only temporarily **electrically connect** an **NSP** under subclause (1) or (2) if a **metering equipment provider** requests that the **local network** owner or **embedded network** owner temporarily **electrically connect** the **NSP** for the purposes of—
 - (a) **certifying** a **metering installation** at the **NSP**; or
 - (b) maintaining, repairing, testing, or **commissioning** a **metering installation** at the **NSP**.
- (4) Despite subclause (3), a **metering equipment provider** must not request that a **local network** owner or an **embedded network** owner temporarily **electrically connect** an **NSP** under subclause (1) or (2) unless—
 - (a) the **reconciliation participant** responsible for the **NSP** authorises the **metering equipment provider** to do so; and
 - (b) the **metering equipment provider** has an arrangement with that **reconciliation participant** to provide **metering** services.

Clause 10.30A: inserted, on 5 October 2017, by clause 169 of the Electricity Industry Participation Code Amendment (Code Review Programme) 2017.

Clause 10.30A: replaced, on 1 February 2021, by clause 10 of the Electricity Industry Participation Code Amendment (Metering and Related Registry Processes) 2020.

10.30B When distributor may electrically connect NSP that is not point of connection to grid

- (1) Subject to clause 10.33A, only a **distributor** may, on its **network**, **electrically connect** an **NSP** that is not a **point of connection** to the **grid**.
- (2) A **distributor** may only **electrically connect** an **NSP** under subclause (1) that is not an **interconnection point** between two **local networks** if—
 - (a) each **distributor** whose **network** is directly connected to the **NSP** has agreed to the **electrical connection**; and
 - (b) 1 or more **traders** are identified as responsible under Part 15 for the delivery of **submission information** for the **electricity** conveyed at the **NSP** from the time of **electrical connection** and that **trader** or those **traders** have—
 - (i) requested the **electrical connection**; and

- (ii) confirmed to the **distributor** that the **metering installation** at the **NSP** is **certified** and operational.
 - (3) A **distributor** may only **electrically connect** an **NSP** under subclause (1) that is an **interconnection point** between two **local networks** if the **reconciliation participant** responsible for the delivery of **submission information** for the **NSP**—
 - (a) has requested the **electrical connection**; and
 - (b) has confirmed the **metering installation** at the **NSP** is **certified** and operational.
- Clause 10.30B: inserted, on 1 February 2021, by clause 11 of the Electricity Industry Participation Code Amendment (Metering and Related Registry Processes) 2020.

Disconnecting and electrically disconnecting NSPs

10.30C Distributor may electrically disconnect or disconnect NSP that is not point of connection to grid

- (1) Subject to subclause (2), only a **distributor** may, on its **network**—
 - (a) **electrically disconnect** an **NSP** that is not a **point of connection** to the **grid**; or
 - (b) **disconnect** an **NSP** that is not a **point of connection** to the **grid**.
- (2) A **distributor** may take one of the actions under subclause (1) only if the action is required for the **distributor** to meet its obligations—
 - (a) under an enactment, including this Code; or
 - (b) under its contract with the **trader** or **traders** responsible for the delivery of **submission information** under Part 15 for the **electricity** conveyed at the **NSP**.

Clause 10.30C: inserted, on 1 February 2021, by clause 11 of the Electricity Industry Participation Code Amendment (Metering and Related Registry Processes) 2020.

10.31 When distributor may connect ICP that is not NSP

- (1) Only a **distributor** may, on its **network**, connect an **ICP** that is not an **NSP**.
- (2) Despite subclause (1), a **distributor** must not connect an **ICP** that is not an **NSP** unless—
 - (a) the **trader** trading at the **ICP** has requested the connection; or
 - (b) in the following circumstances:
 - (i) there is only **shared unmetered load** at the **ICP**; and
 - (ii) in accordance with clause 11.14, the **distributor** has—
 - (A) assigned the **shared unmetered load**; and
 - (B) advised each **trader**, that is responsible under clause 11.18(1) for the **ICPs** across which the **unmetered load** is shared, of that assignment.

Clause 10.31: substituted, on 29 August 2013, by clause 20 of the Electricity Industry Participation (Metering Arrangements) Code Amendment 2011, Amendment 2013 (No 2).

Clause 10.31(a): amended, on 23 February 2015, by clause 75 of the Electricity Industry Participation Code Amendment (Distributed Generation) 2014.

Clause 10.31: replaced, on 5 October 2017, by clause 170 of the Electricity Industry Participation Code Amendment (Code Review Programme) 2017.

Clause 10.31(1): amended, on 1 November 2018, by clause 24(1) of the Electricity Industry Participation Code Amendment (Code Review Programme) 2018.

Clause 10.31(2): replaced, on 1 November 2018, by clause 24(2) of the Electricity Industry Participation Code Amendment (Code Review Programme) 2018.

10.31A When distributor may temporarily electrically connect ICP that is not NSP

- (1) Subject to clause 10.33, only a **distributor** may, on its **network**, temporarily **electrically connect** an **ICP** that is not an **NSP**.

- (2) A **distributor** may only temporarily **electrically connect** an **ICP** that is not an **NSP**—
- (a) if a **metering equipment provider** requests that the **distributor** temporarily **electrically connect** the **ICP** for the purposes of—
- (i) **certifying a metering installation** at the **ICP**; or
- (ii) maintaining, repairing, testing, or **commissioning a metering installation** at the **ICP**; or
- (b) in the following circumstances:
- (i) there is only **shared unmetered load** at the **ICP**; and
- (ii) in accordance with clause 11.14, the **distributor** has—
- (A) assigned the **shared unmetered load**; and
- (B) advised each **trader**, that is responsible under clause 11.18(1) for the **ICPs** across which the **unmetered load** is shared, of that assignment; and
- (iii) the **distributor** has advised those **traders** of the **distributor's** intention to temporarily **electrically connect** the **ICP**.
- (3) Despite subclause (2)(a), a **metering equipment provider** must not request that a **distributor** temporarily **electrically connect** an **ICP** that is not an **NSP** unless—
- (a) the **trader** responsible for the **ICP** has authorised the **metering equipment provider** to do so; and
- (b) the **metering equipment provider** has an arrangement with that **trader** to provide **metering** services.
- (4) Despite subclause (2)(b), the **distributor** need not advise the **traders** of the **distributor's** intention to temporarily **electrically connect** the **ICP** if—
- (a) advising all **traders** would impose a material cost on the **distributor**; and
- (b) in the **distributor's** reasonable opinion, advising the **traders** would not result in any material benefit to any of the **traders**. Clause 10.31A: inserted, on 5 October 2017, by clause 171 of the Electricity Industry Participation Code Amendment (Code Review Programme) 2017.
Clause 10.31A(1): amended, on 1 November 2018, by clause 25(1) of the Electricity Industry Participation Code Amendment (Code Review Programme) 2018.
Clause 10.31A(2): replaced, on 1 November 2018, by clause 25(2) of the Electricity Industry Participation Code Amendment (Code Review Programme) 2018.
Clause 10.31A(3): amended, on 1 November 2018, by clause 25(3) of the Electricity Industry Participation Code Amendment (Code Review Programme) 2018.
Clause 10.31A(4): inserted, on 1 November 2018, by clause 25(4) of the Electricity Industry Participation Code Amendment (Code Review Programme) 2018.

10.31B When distributor may electrically connect ICP that is not NSP

- (1) A **distributor** may **electrically connect** an **ICP** that is not an **NSP** only if—
- (a) there is only **shared unmetered load** at the **ICP**; and
- (b) in accordance with clause 11.14, the **distributor** has—
- (i) assigned the **shared unmetered load**; and
- (ii) advised each **trader**, that is responsible under clause 11.18(1) for the **ICPs** across which the **unmetered load** is shared, of that assignment; and
- (c) the **distributor** has advised those **traders** of the **distributor's** intention to **electrically connect** the **ICP**.
- (2) Despite subclause (1)(c), the **distributor** need not advise the **traders** of the **distributor's** intention to **electrically connect** the **ICP** if—
- (a) the **distributor** is doing so following a maintenance outage; and
- (b) advising all **traders** would impose a material cost on the **distributor**; and
- (c) in the **distributor's** reasonable opinion, advising the **traders** would not result in

any material benefit to any of the **traders**.

Clause 10.31B: inserted, on 1 November 2018, by clause 26 of the Electricity Industry Participation Code Amendment (Code Review Programme) 2018.

Clause 10.31B(2): amended, on 20 December 2021, by clause 27 of the Electricity Industry Participation Code Amendment (Code Review Programme) 2019.

Disconnecting and electrically disconnecting ICPs

10.31C Distributor may electrically disconnect or disconnect ICP that is not an NSP

- (1) Subject to subclause (2), only a **distributor** may, on its **network**,—
 - (a) **electrically disconnect** an **ICP** that is not an **NSP**; or
 - (b) **disconnect** an **ICP** that is not an **NSP**.
- (2) A **distributor** may take one of the actions under subclause (1) only if the action is required for the **distributor** to meet its obligations—
 - (a) under an enactment, including this Code; or
 - (b) under its contract with the **trader** recorded in the **registry** as being responsible for the **ICP**; or
 - (c) under its contract with the **consumer** at the **ICP**.

Cross heading and clause 10.31C: inserted, on 1 February 2021, by clause 12 of the Electricity Industry Participation Code Amendment (Metering and Related Registry Processes) 2020.

10.32 Reconciliation participant requesting connection of point of connection

For the purposes of clauses 10.30(1) and 10.31(2), a **reconciliation participant** must only request the connection of a **point of connection** if the **reconciliation participant**—

- (a) accepts responsibility for the **reconciliation participant's** obligations in this Part and Parts 11 and 15 for the **point of connection**; and
- (b) has an arrangement with a **metering equipment provider** to provide 1 or more **metering installations** for the **point of connection**.

Clause 10.32 Heading: amended, on 29 August 2013, by clause 21(1) of the Electricity Industry Participation (Metering Arrangements) Code Amendment 2011, Amendment 2013 (No 2).

Clause 10.32 Heading: amended, on 5 October 2017, by clause 172(1) of the Electricity Industry Participation Code Amendment (Code Review Programme) 2017.

Clause 10.32: amended, on 29 August 2013, by clause 21(2) of the Electricity Industry Participation (Metering Arrangements) Code Amendment 2011, Amendment 2013 (No 2).

Clause 10.32: amended, on 5 October 2017, by clause 172(2) of the Electricity Industry Participation Code Amendment (Code Review Programme) 2017.

10.33 When trader may temporarily electrically connect a point of connection

- (1) A **trader** may temporarily **electrically connect** a **point of connection**, or a **metering equipment provider** authorised by a **trader** under subclause (2) may temporarily **electrically connect** a **point of connection** only if—
 - (aa) for an **NSP** that is a **point of connection** to the **grid**, the **grid owner** has approved—
 - (i) the **trader** temporarily **electrically connecting** the **point of connection**; or
 - (ii) the **trader** authorising the temporary **electrical connection** of the **point of connection**;
 - (ab) for an **NSP** that is not a **point of connection** to the **grid**, the **distributor** that gave notice to the **reconciliation manager** under clause 25 of Schedule 11.1 has approved—
 - (i) the **trader** temporarily **electrically connecting** the **point of connection**; or
 - (ii) the **trader** authorising the temporary **electrical connection** of the **point of**

connection:

- (a) for a **point of connection** that is an **ICP**, but which is not an **NSP**,—
 - (i) either:
 - (A) the **trader** is recorded in the **registry** as being responsible for the **ICP**; or
 - (B) if the **ICP** has been **electrically disconnected**, the **trader**—
 - (1) has an arrangement with a customer or **embedded generator** at the **ICP**; and
 - (2) initiates a switch under one of clauses 2, 9, or 14 of Schedule 11.3 within 2 **business days** of the date of **electrical connection**; and
 - (3) accepts responsibility to provide **submission information** under Part 15 or for the losing **trader's** direct costs for the **electricity** conveyed at the **ICP**, from the date of **electrical connection**; and
 - (ii) if the **ICP** has metered load, 1 or more operational **certified metering installations** are connected at the **ICP** in accordance with this Part; and
 - (iii) if the **ICP** has not previously been **electrically connected**, the owner of the **network** to which the **point of connection** is connected has given written approval to the temporary **electrical connection**.
- (b) *[Revoked]*
- (c) *[Revoked]*
- (2) A **trader** described in subclause (1) may authorise a **metering equipment provider**, with which the **trader** has an arrangement, to request the temporary **electrical connection** of a **point of connection** only for the purposes of—
 - (a) **certifying a metering installation** at the **point of connection**; or
 - (b) maintaining, repairing, testing, or **commissioning a metering installation** at the **point of connection**.
- (3) *[Revoked]*
- (4) *[Revoked]*

Clause 10.33: replaced, on 1 February 2021, by clause 13 of the Electricity Industry Participation Code Amendment (Metering and Related Registry Processes) 2020.

Heading: amended, on 5 October 2017, by clause 173(a) of the Electricity Industry Participation Code Amendment (Code Review Programme) 2017.

Clause 10.33: substituted, on 29 August 2013, by clause 22 of the Electricity Industry Participation (Metering Arrangements) Code Amendment 2011, Amendment 2013 (No 2).

Clause 10.33(1): amended, on 5 October 2017, by clause 173(b) of the Electricity Industry Participation Code Amendment (Code Review Programme) 2017.

Clause 10.33(1)(aa) and (ab): inserted, on 1 November 2018, by clause 27(1) of the Electricity Industry Participation Code Amendment (Code Review Programme) 2018.

Clause 10.33(1)(a): replaced, on 1 November 2018, by clause 27(1) of the Electricity Industry Participation Code Amendment (Code Review Programme) 2018.

Clause 10.33(1)(b) and (c): revoked, on 1 November 2018, by clause 27(2) of the Electricity Industry Participation Code Amendment (Code Review Programme) 2018.

Clause 10.33(1)(c): amended, on 23 February 2015, by clause 75 of the Electricity Industry Participation Code Amendment (Distributed Generation) 2014.

Clause 10.33(1)(c): amended, on 1 February 2016, by clause 27 of the Electricity Industry Participation Code Amendment (Code Review Programme) 2015.

Clause 10.33(2): replaced, on 5 October 2017, by clause 173(c) of the Electricity Industry Participation Code Amendment (Code Review Programme) 2017.

Clause 10.33(2): amended, on 1 November 2018, by clause 27(3) of the Electricity Industry Participation Code Amendment (Code Review Programme) 2018.

Clause 10.33(3) and (4): revoked, on 5 October 2017, by clause 173(d) of the Electricity Industry Participation Code Amendment (Code Review Programme) 2017.

10.33A When trader may electrically connect point of connection

- (1) A trader may electrically connect a point of connection, or another participant authorised by a trader may electrically connect a point of connection, only if—
- (aa) for an NSP that is a point of connection to the grid, the grid owner has approved—
 - (i) the trader electrically connecting the point of connection to the grid that the grid owner owns or operates; or
 - (ii) the trader authorising the electrical connection of the point of connection to the grid that the grid owner owns or operates:
 - (ab) for an NSP that is not a point of connection to the grid, the distributor that gave notice to the reconciliation manager under clause 25 of Schedule 11.1 has approved—
 - (i) the trader electrically connecting the point of connection to the network that the distributor owns or operates; or
 - (ii) the trader authorising the electrical connection of the point of connection to the network that the distributor owns or operates:
 - (a) for a point of connection that is an ICP, but which is not an NSP,—
 - (i) either—
 - (A) the trader is recorded in the registry as being responsible for the ICP; or
 - (B) if the ICP has been electrically disconnected, the trader—
 - (1) has an arrangement with a customer or embedded generator at the ICP; and
 - (2) initiates a switch under clause 2, 9, or 14 of Schedule 11.3 within 2 business days of the date of electrical connection; and
 - (3) accepts responsibility to provide submission information in accordance with Part 15 or for the losing trader's direct costs for the electricity conveyed at the ICP from the date of electrical connection; and
 - (ii) if the ICP has metered load, 1 or more operational certified metering installations are connected at the ICP in accordance with this Part; and
 - (iii) if the ICP has not previously been electrically connected, the owner of the network to which the point of connection is connected has given written approval of the electrical connection:
 - (b) *[Revoked]*
 - (c) *[Revoked]*
 - (d) the point of connection supplies electricity to a load that is assigned to multiple ICPs as shared un-metered load and the distributor to whose network the point of connection is connected has advised all traders that are assigned the shared un-metered load of the trader's intention to electrically connect the point of connection.
- (2) Further to subclause (1), a trader described in subclause (1)(a)(i)—
- (a) may authorise the electrical connection of an ICP if—
 - (i) a metering installation is in place at the ICP; and

- (ii) the **metering installation** is operational but not **certified**; and
 - (iii) the **trader** arranges for the **certification** of the **metering installation** to be completed within 5 **business days** of the **ICP** being **electrically connected**;
or
 - (b) may **electrically connect** an **ICP** if the **point of connection** is solely for **unmetered load**.
- (3) A **trader** must not **electrically connect** or authorise the **electrical connection** of a **point of connection** in any of the following circumstances—
- (a) a **distributor** has **electrically disconnected** the **point of connection** for safety reasons, and has not subsequently approved the **electrical connection** of the **point of connection**;
 - (b) **electrically connecting** the **point of connection** would breach the Electricity (Safety) Regulations 2010;
 - (c) a switch described in subclause (1)(a)(i)(B)(2) has been withdrawn or reversed.
- (4) No **participant** may **electrically connect** a **point of connection**, or authorise the **electrical connection** of a **point of connection**, other than—
- (a) a **trader** in the circumstances described in subclauses (1) to (3); or
 - (b) a **distributor** in the circumstances described in clause 10.31B.
- (5) Under subclause (1)(a)(i), if a **trader** or a person **authorised** by a **trader** **electrically connects** an **electrically disconnected point of connection** in error, or prior to the switch being withdrawn or reversed, the **trader** must—
- (a) **electrically disconnect** the **ICP**—
 - (i) using the same method of **electrical disconnection** as the losing **trader** used; or
 - (ii) by, if the method of **electrical connection** was bypass, removing the bypass; and
 - (b) reimburse the losing **trader** for any direct costs the losing **trader** incurred because of the **electrical connection** of the **point of connection**—
 - (i) in error; or
 - (ii) prior to the switch being withdrawn or reversed.

Clause 10.33A: replaced, on 1 February 2021, by clause 13 of the Electricity Industry Participation Code Amendment (Metering and Related Registry Processes) 2020.

Clause 10.33A: inserted, on 5 October 2017, by clause 174 of the Electricity Industry Participation Code Amendment (Code Review Programme) 2017.

Clause 10.33A(1)(aa) and (ab): inserted, on 1 November 2018, by clause 28(1) of the Electricity Industry Participation Code Amendment (Code Review Programme) 2018.

Clause 10.33A(1)(a): replaced, on 1 November 2018, by clause 28(1) of the Electricity Industry Participation Code Amendment (Code Review Programme) 2018.

Clause 10.33A(1)(b) and (c): revoked, on 1 November 2018, by clause 28(2) of the Electricity Industry Participation Code Amendment (Code Review Programme) 2018.

Clause 10.33A(2): amended, on 1 November 2018, by clause 28(3) of the Electricity Industry Participation Code Amendment (Code Review Programme) 2018.

Clause 10.33A(4): replaced, on 1 November 2018, by clause 28(4) of the Electricity Industry Participation Code Amendment (Code Review Programme) 2018.

Disconnecting and electrically disconnecting points of connection

10.33B Trader must not disconnect or electrically disconnect ICP for which it is not responsible

Unless a **trader** is recorded in the **registry** as being responsible for an **ICP** or is meeting its obligation under clause 10.33A(5)(a) in respect of an **ICP**, the **trader** must

not—

- (a) **electrically disconnect** the ICP; or
- (b) **disconnect** the ICP; or
- (c) authorise a **metering equipment provider**—
 - (i) to **electrically disconnect** the ICP; or
 - (ii) to **disconnect** the ICP.

Cross Heading and Clause 10.33B: inserted, on 1 February 2021, by clause 14 of the Electricity Industry Participation Code Amendment (Metering and Related Registry Processes) 2020.

Clause 10.33B(a): amended, on 1 March 2024, by clause 37 of the Electricity Industry Participation Code Amendment (Code Review Programme) 2024.

10.33C When trader may bridge meter at ICP

- (1) Subject to subclause (2), only a **trader** that is responsible for an ICP or a **metering equipment provider** authorised by the **trader** or a **distributor** authorised by the **trader**, in **electrically connecting** an ICP, may **electrically connect** the ICP in a way that bypasses the **meter** or **meters** that are in place to record the **electricity** flowing through the ICP (“bridge” a **meter**).
- (2) A **trader** may authorise a **metering equipment provider** or **distributor** under subclause (1)—
 - (a) generally for all or some of the ICPs that the **trader** is responsible for; or
 - (b) for a specific ICP that the **trader** is responsible for.
- (3) A **trader** that is responsible for an ICP, or a **metering equipment provider** authorised by the **trader** or a **distributor** authorised by the **trader**, may only bridge a **meter** at the ICP if—
 - (a) the **metering equipment provider** responsible for the **meter**, despite best endeavours,—
 - (i) is unable to remotely **electrically connect** the ICP so that **electricity** flows through the **meter**; or
 - (ii) cannot, because of safety issues, repair a fault with the **meter** that prevents **electricity** flowing through the **meter** at the ICP; and
 - (b) the **consumer** at the ICP will likely be without **electricity** for a period of time that will cause significant disadvantage to the **consumer**.
- (4) If a **meter** is bridged under subclause (1) by the **metering equipment provider** or **distributor**, the **metering equipment provider** or **distributor** (as the case may be) must, within 1 **business day**, advise the **trader** responsible for the ICP that the **meter** is bridged and include the date that bridging occurred in its advice.
- (5) If a **meter** is bridged under subclause (1), in all cases, the **trader** responsible for the ICP must—
 - (a) determine, in accordance with clause 2A of Schedule 15.2, the quantity of **electricity** conveyed through the ICP for the period of time the **meter** is bridged; and
 - (b) submit that estimated quantity of **electricity** to the **reconciliation manager** in accordance with clause 15.4; and
 - (c) within 1 **business day** of being advised that the **meter** is bridged, notify the **metering equipment provider** responsible for the bridged **meter** that it is

required to reinstate the **meter** so that all **electricity** flowing into the **ICP** flows through a certified **metering installation**.

- (6) The **metering equipment provider** receiving the notice under subclause (5)(c) must reinstate the **meter** so that all electricity flowing into the **ICP** flows through a certified **metering installation** within 5 **business days** of receiving the notice.”

Clause 10.33C: inserted, on 1 February 2021, by clause 14 of the Electricity Industry Participation Code Amendment (Metering and Related Registry Processes) 2020.

General metering installation requirements

10.34 Installation and modification of metering installations

- (1) This clause applies to a **metering equipment provider** that proposes to install or modify a **metering installation** at a **point of connection** other than a **point of connection** to the **grid**.
- (2) The **metering equipment provider** must consult with the **distributor** and the **trader** for the **point of connection** on the matters specified in subclause (2A), before—
- (a) finalising the design of a **metering installation** for the **point of connection**; or
 - (b) modifying the design of a **metering installation** installed at the **point of connection**; or
 - (c) finalising or modifying the design of a **metering installation** when replacing a **metering component** or **metering installation** with a new **metering component** or new **metering installation**, even if the new **metering component** or **metering installation** has the same or similar design and functionality as the existing **metering component** or **metering installation**.
- (2A) The **metering component's** or matters referred to in subclause (2) are the **metering installation's**—
- (a) required functionality; and
 - (b) terms of use; and
 - (c) required interface format; and
 - (d) integration of the ripple receiver and the **meter**; and
 - (e) functionality for controllable load.
- (2B) In addition to subclause (2), any consultation carried out under subclause (2), and any agreement that may be reached in that consultation, does not affect the application of clause 19 of Schedule 10.7.
- (2C) Despite subclause (2), the **metering equipment provider** does not need to consult with—
- (a) the **distributor** if the **metering equipment provider** has already consulted with the **distributor** on the design of—
 - (i) a **metering component** or **metering installation** that has the same or similar design and functionality as the replacement **metering component** or **metering installation**; or
 - (ii) the new **metering installation**; or
 - (b) the **trader** if the **metering equipment provider** has already consulted with the **trader** on the design of—
 - (i) a **metering component** or **metering installation** that has the same or similar design and functionality as the replacement **metering component** or

- metering installation; or**
- (ii) the new **metering installation**.
- (2D) To avoid doubt, subclause (2C) is intended to permit a **metering equipment provider** to re-use the design of a **metering component** or **metering installation** if—
- (a) the **metering equipment provider** has already consulted the **distributor** and **trader** in accordance with subclause (2); and
- (b) the **metering equipment provider** will re-use the design of the **metering component** or **metering installation**—
- (i) on the **distributor's network**; and
- (ii) at an **ICP** for which the **trader** is responsible.
- (3) Each **participant** involved in the consultation referred to in subclause (2) must—
- (a) use its best endeavours to reach agreement; and
- (b) act reasonably and in good faith.
- (4) If the **participants** referred to in subclause (2) cannot agree, within 20 **business days** of the **distributor** first being advised of the proposed new or modified **metering installation**, on the **metering installation's** requirements set out in subclause (2A)(a) to (e)—
- (a) an affected **participant** may refer the matter to the **Authority** under clause 10.50 by advising the **Authority**—
- (i) that agreement has not been reached; and
- (ii) of the identity of all affected **participants**; and
- (iii) the reasons (if and to the extent known) why agreement was not reached; and
- (b) the **Authority**—
- (i) may, at its discretion, determine the **metering installation** requirements; and
- (ii) must, if it determines the **metering installation** requirements,—
- (A) do so in accordance with clause 10.50(4); and
- (B) advise each affected **participant** of the determination it has made

Clause 10.34(1) and (2): substituted, on 1 February 2016, by clause 28(1) of the Electricity Industry Participation Code Amendment (Code Review Programme) 2015.

Clause 10.34(2): amended, on 1 May 2016, by clause 6 of the Electricity Industry Participation Code Amendment (Minor Code Amendments) 2016.

Clause 10.34(2)(b): amended, on 1 February 2021, by clause 15(1)(a) of the Electricity Industry Participation Code Amendment (Metering and Related Registry Processes) 2020.

Clause 10.34(2)(c): inserted, on 1 February 2021, by clause 15(1)(b) of the Electricity Industry Participation Code Amendment (Metering and Related Registry Processes) 2020.

Clause 10.34(2A): inserted, on 1 February 2016, by clause 28(2) of the Electricity Industry Participation Code Amendment (Code Review Programme) 2015.

Clause 10.34(2A): amended, on 1 February 2021, by clause 15(2) of the Electricity Industry Participation Code Amendment (Metering and Related Registry Processes) 2020.

Clause 10.34(2B), (2C) and (2D): inserted, on 1 February 2021, by clause 15(3) of the Electricity Industry Participation Code Amendment (Metering and Related Registry Processes) 2020.

Clause 10.34(4): amended, on 1 February 2016, by clause 28(3) of the Electricity Industry Participation Code Amendment (Code Review Programme) 2015.

10.35 Physical location of metering installations

- (1) A **reconciliation participant** responsible for ensuring there is a **category 1 metering installation** or **category 2 metering installation** must ensure that the **metering installation** is located as physically close to a **point of connection** as practical in the

circumstances.

- (2) A **reconciliation participant** responsible for ensuring there is a category 3 or higher **metering installation** must,—
 - (a) if practical in the circumstances, ensure that the **metering installation** is located at a **point of connection**; or
 - (b) if it is not practical in the circumstances to locate the **metering installation** at the **point of connection**, calculate the quantity of **electricity** conveyed through the **point of connection** using a **loss compensation** process approved by the **certifying ATH**.
- (3) If a calculation is carried out under subclause (2)(b), the certifying **ATH** must record in the **metering installation certification report**—
 - (a) the details of the calculation; and
 - (b) any assumption used; and
 - (c) any measurement used.
- (4) This clause does not apply to an existing **metering installation** that is in place on 29 August 2013.

Clause 10.35(3): amended, on 29 August 2013, by clause 23(1) of the Electricity Industry Participation (Metering Arrangements) Code Amendment 2011, Amendment 2013 (No 2).

Clause 10.35(4): amended, on 29 August 2013, by clause 23(2) of the Electricity Industry Participation (Metering Arrangements) Code Amendment 2011, Amendment 2013 (No 2).

10.36 Reconciliation participant to have arrangement with metering equipment provider

A **reconciliation participant** must, before accepting responsibility to be the **reconciliation participant** for a **point of connection**, enter into an arrangement with a **metering equipment provider**—

- (a) for the **reconciliation participant** to provide the **metering equipment provider** with physical access to the **metering installation** for the **point of connection** and the premises at which it is situated; and
- (b) arranging for the **electrical disconnection** of the **point of connection**, if required by the **metering equipment provider** to enable the **metering equipment provider** to comply with its obligations under this Part; and
- (c) for the **metering equipment provider** to provide the **reconciliation participant** with access at the **services access interface** to the **metering data** from the **metering installation** for the **point of connection**, in accordance with an authorisation from—
 - (i) in the case of an **ICP**, the **consumer**; or
 - (ii) in the case of an **NSP**, the **network** owner.

Clause 10.36(b): amended, on 5 October 2017, by clause 175 of the Electricity Industry Participation Code Amendment (Code Review Programme) 2017.

Active and reactive energy metering

10.37 Active and reactive measuring and recording requirements

- (1) A **metering equipment provider** must ensure that each **half-hour metering installation** that is a **category 3 metering installation**, or higher category of **metering installation**, certified after 29 August 2013, measures and separately records, in accordance with this Part,—

- (a) if the measuring and recording requirement is for consumption only—
 - (i) import **active energy**; and
 - (ii) import **reactive energy**; and
 - (iii) export **reactive energy**; or
 - (b) if the measuring and recording requirement is for consumption and generation, or generation only—
 - (i) import **active energy**; and
 - (ii) export **active energy**; and
 - (iii) import **reactive energy**; and
 - (iv) export **reactive energy**.
- (1A) A **metering equipment provider** must ensure that each **half-hour metering installation** that is a **category 2 metering installation, certified** after 29 August 2013, is capable of measuring and recording—
- (a) import **active energy**; and
 - (b) export **active energy**; and
 - (c) import **reactive energy**; and
 - (d) export **reactive energy**.
- (1B) A **metering equipment provider** must ensure that each **half-hour metering installation** that is a **category 2 metering installation, certified** after 29 August 2013, measures and separately records, in accordance with this Part,—
- (a) if the measuring and recording requirement is for consumption only, import **active energy**; or
 - (b) if the measuring and recording requirement is for consumption and generation, or generation only—
 - (i) import **active energy**; and
 - (ii) export **active energy**.
- (2) Despite subclauses (1)(a) and (1B)—
- (a) each **metering installation**, for a **point of connection** to the **grid, certified** after 29 August 2013, must measure and separately record—
 - (i) import **active energy**; and
 - (ii) export **active energy**; and
 - (iii) import **reactive energy**; and
 - (iv) export **reactive energy**; and
 - (b) the accuracy of each local service **metering installation** for **electricity** used in and by a **grid** substation must be within the applicable accuracy tolerances set out in Table 1 of Schedule 10.1.

Clause 10.37: amended, on 29 August 2013, by clause 24 of the Electricity Industry Participation (Metering Arrangements) Code Amendment 2011, Amendment 2013 (No 2).

Clause 10.37(1): amended, on 1 February 2016, by clause 29(1) of the Electricity Industry Participation Code Amendment (Code Review Programme) 2015.

Clause 10.37(1A) and (1B): inserted, on 1 February 2016, by clause 29(2) of the Electricity Industry Participation Code Amendment (Code Review Programme) 2015.

Clause 10.37(2): amended, on 1 February 2016, by clause 29(3) of the Electricity Industry Participation Code Amendment (Code Review Programme) 2015.

Certification of metering installations

10.38 Certification of metering installations

A **metering equipment provider** must—

- (a) obtain and maintain **certification** in accordance with this Part—
 - (i) for each **metering installation** for which it is responsible; and
 - (ii) for each **metering component** in a **metering installation** for which it is responsible; and
- (b) ensure that any tests required for **certification** under paragraph (a) are conducted in accordance with this Code including the obligations under Schedule 10.7 or 10.8 (whichever is applicable) by an **ATH** contracted by the **metering equipment provider**.

Metering infrastructure

10.39 Responsibility for metering infrastructure integration

- (1) A **metering equipment provider** must ensure that—
 - (a) for each **metering installation** for which it is responsible, an appropriately designed **metering infrastructure** is in place; and
 - (b) in each **metering installation** for which it is responsible,—
 - (i) each **metering component** is compatible with, and will not cause any interference with the operation of, any other **metering component** in the **metering installation**; and
 - (ii) collectively, all **metering components** integrate to provide a functioning system; and
 - (c) each **metering installation** for which it is responsible is correctly and accurately integrated within the associated **metering infrastructure**.
- (2) Subclause (1) does not apply to an **electrically disconnected metering installation** for an **ICP**.

Clause 10.39(2): amended, on 5 October 2017, by clause 176 of the Electricity Industry Participation Code Amendment (Code Review Programme) 2017.

Approved test houses and ATHs

10.40 General requirements for approval as ATH

- (1) A person wishing to be approved as an **ATH**, or an **ATH** wishing to renew its approval, must apply to the **Authority**—
 - (a) at least 2 months before the intended effective date of the approval or renewal; and
 - (b) in writing; and
 - (c) in the **prescribed form**; and
 - (d) in accordance with Schedule 10.3.
- (2) A person making an application must satisfy the **Authority** (providing, where appropriate, suitable evidence) that the person—
 - (a) has the facilities and procedures to reliably meet, for the requested term of the approval, the minimum requirements of this Code for the class or classes of **ATH** for which it is seeking approval; and
 - (b) has had an **audit** under Part 16A; and

- (c) is a fit and proper person for approval.
- (3) Any **approved test house** operated solely by an **ATH** is, for all purposes of this Code and the **Act**, deemed to be approved in accordance with the procedures in the Code.
- Clause 10.40(2)(b): amended, on 1 June 2017, by clause 9 of the Electricity Industry Participation Code Amendment (Requirements and Processes for Audits) 2016.

10.41 Requirements applying to ATHs

An **ATH** must, when carrying out activities under this Part,—

- (a) only carry out activities for which it has been approved by the **Authority**; and
- (b) exercise a degree of skill, diligence, prudence, foresight, and economic management, taking into account the technological complexity of the **metering components** and **metering installations** being tested—
 - (i) determined by reference to good industry practice; and
 - (ii) that would reasonably be expected from a skilled and experienced **ATH** engaged in the management and operation of an **approved test house**; and
- (c) comply with all applicable safety, employment, environmental, and other enactments; and
- (d) exercise any discretion given to it under this Part by—
 - (i) taking into account the relevant circumstances of the particular instance; and
 - (ii) acting professionally; and
- (e) record the manner in which it carried out its activities and its reasons for carrying the activities out in that manner.

10.42 ATH's functions and ongoing obligations

- (1) An **ATH** must comply with this Code including Schedules 10.4, 10.7, and 10.8.
- (2) An **ATH** must, if this Part requires an **ATH** to complete a function or activity before a **metering installation** is **certified**, complete the function or activity as part of the process undertaken to obtain **certification** for the **metering installation**.

Metering installations that are inaccurate, defective, or not fit for purpose

10.43 Metering installations that are inaccurate, defective, or not fit for purpose to be investigated

- (1) For the purposes of this clause and clauses 10.44 to 10.48, a **metering installation** is—
 - (a) accurate, if it is within the applicable accuracy tolerances set out in Table 1 of Schedule 10.1;
 - (b) inaccurate, if it is outside the applicable accuracy tolerances set out in Table 1 of Schedule 10.1.
- (2) A **participant** must comply with this clause and clauses 10.44 to 10.48 if—
 - (a) in the case of a **metering equipment provider**, it is advised under subclause (3)(a); or
 - (b) it becomes aware of an event or circumstance that leads it to believe a **metering installation** is or could be—
 - (i) inaccurate; or
 - (ii) defective; or

- (iii) not fit for purpose.
- (3) A **participant** referred to in subclause (2)(b), other than the **metering equipment provider** responsible for the **metering installation**, must—
 - (a) advise the **metering equipment provider** responsible for the **metering installation** that it has become aware of an event or circumstance that leads it to believe the **metering installation** is or could be—
 - (i) inaccurate; or
 - (ii) defective; or
 - (iii) not fit for purpose; and
 - (b) include, with the advice (if and to the extent they are known), all relevant details.
- (4) A **metering equipment provider** must, if it is advised under subclause (3)(a), or becomes aware as referred to in subclause (2)(b), within the period set out in subclause (5),—
 - (a) investigate—
 - (i) if it is advised under subclause (3)(a), the event or circumstance that it is advised of; or
 - (ii) if it becomes aware as referred to in subclause (2)(b), the event or circumstance that leads it to believe the **metering installation** is or could be—
 - (A) inaccurate; or
 - (B) defective; or
 - (C) not fit for purpose; and
 - (b) complete, or arrange the completion of, a report that contains details of the **metering equipment provider's** investigation, its conclusion, and the reasons for its conclusion; and
 - (c) provide the report to all affected **participants**.
- (5) The time period for the purposes of subclause (4) is as soon as reasonably practicable, but no later than—
 - (a) 20 **business days** after becoming aware of the event or circumstance, for a **category 1 metering installation**;
 - (b) 10 **business days** after becoming aware of the event or circumstance, for a **category 2 metering installation**;
 - (c) 5 **business days** after becoming aware of the event or circumstance, for a category 3 or higher **metering installation**.

10.44 Metering installations that are inaccurate, defective, or not fit for purpose to be tested

- (1) A **metering equipment provider** must, if a report provided under clause 10.43(4)(c) demonstrates that a **metering installation** for which it is responsible is inaccurate, defective, or not fit for purpose—
 - (a) arrange testing of the **metering installation** by an **ATH**; and
 - (b) arrange the provision of a statement of situation referred to in clause 10.46 by the **ATH**.
- (2) If the report demonstrates that a **metering installation** is accurate, not defective, and fit

- for purpose, a **participant** who believes that the **metering installation** is inaccurate, defective, or not fit for purpose, may require testing of the **metering installation** by—
- (a) advising the **metering equipment provider** responsible for the **metering installation**, within 5 **business days** of receiving the report, of—
 - (i) its reasons for requiring testing; and
 - (ii) the scope of the testing required; and
 - (b) using its best endeavours to agree with the **metering equipment provider** on an **ATH** who will test the **metering installation** and provide a statement of situation under subclause (1).
- (3) A **metering equipment provider** who has been advised under subclause (2)(a) that a **participant** believes that a **metering installation**, for which the **metering equipment provider** is responsible, requires testing, must arrange for an **ATH**—
- (a) to test the **metering installation**; and
 - (b) to provide the **metering equipment provider** with a statement of situation under subclause (1)(b) within 5 **business days** of—
 - (i) becoming aware that a **metering installation** for which it is responsible may be inaccurate, defective, or not fit for purpose under subclause (1); or
 - (ii) reaching an agreement with the **participant** under subclause (2)(b).
- (4) If the **metering equipment provider** and the **participant** requesting the test under subclause (2) cannot, within 5 **business days** of the **metering equipment provider** being advised under subclause (2)(a), agree on an **ATH**, either **participant** may advise the **Authority**, including the reasons, if and to the extent known, why agreement was not reached.
- (5) The **Authority** must, within 5 **business days** of being advised under subclause (4), advise the **metering equipment provider** of the **ATH** that it must instruct to carry out the testing and to provide a statement of situation under subclause (1)(b).
- (6) The **metering equipment provider** must instruct the **ATH** referred to in subclause (5) within 5 **business days** of being advised by the **Authority**.
- (7) The **metering equipment provider** must ensure that the **ATH**, as soon as practicable after being contracted under subclause (1) or subclause (5), carries out the required testing and delivers the statement of situation to the **metering equipment provider**.
- (8) Despite anything else in this Code, a **participant** is in breach of this Code from when the tests carried out by an **ATH** under this clause demonstrate that a **metering installation** is—
- (a) inaccurate; or
 - (b) defective; or
 - (c) not fit for purpose.

Clause 10.44(4), (5) and (6): amended, on 5 October 2017, by clause 177 of the Electricity Industry Participation Code Amendment (Code Review Programme) 2017.

10.45 Investigation and testing costs

The **ATH**'s costs incurred by the **metering equipment provider** under clause 10.44 must be borne by—

- (a) the **metering equipment provider**, if the investigation or test demonstrates that the **metering installation** is—

- (i) defective; or
- (ii) inaccurate; or
- (iii) not fit for purpose; or
- (b) the **participant** who required that the **metering installation** be investigated or tested, if the investigation or test demonstrates that the **metering installation** is—
 - (i) not defective; and
 - (ii) accurate; and
 - (iii) fit for purpose.

10.46 Statement of situation

- (1) A statement of situation provided by an **ATH** under clause 10.44(1)(b) must include—
 - (a) details of the tests carried out; and
 - (b) results of the tests carried out; and
 - (c) full details of what was found; and
 - (d) conclusions of whether the **metering installation** is—
 - (i) accurate;
 - (ii) defective;
 - (iii) fit for purpose; and
 - (e) the reasons for the conclusions in paragraph (d); and
 - (f) an assessment of the risk to the completeness and accuracy of the **raw meter data**; and
 - (g) the details of any remedial action proposed or undertaken; and
 - (h) any correction factors to apply to **raw meter data** to ensure that the **volume information** is accurate; and
 - (i) the period over which the correction factor must be applied to the **raw meter data**.
- (2) A **metering equipment provider** must, within 3 **business days** of receiving the statement of situation, provide copies of it—
 - (a) to the relevant affected **participants** for all **metering installations**; and
 - (b) to the **Authority**—
 - (i) for all category 3 and above **metering installations**; and
 - (ii) if requested by the **Authority**, for each **category 1 metering installation** and each **category 2 metering installation**.

Clause 10.46(2): substituted, on 15 May 2014, by clause 13 of the Electricity Industry Participation (Minor Code Amendments) Code Amendment 2014.

Clause 10.46(2) (b): amended, on 5 October 2017, by clause 178 of the Electricity Industry Participation Code Amendment (Code Review Programme) 2017.

10.46A Timeframe for correcting defects and inaccuracies in metering installation

- (1) This clause applies to a **metering equipment provider** that becomes aware, or is advised under clause 10.43, that a **metering installation** for which it is responsible, is—
 - (a) inaccurate; or
 - (b) defective; or
 - (c) not fit for purpose.

- (2) A **metering equipment provider** to which this clause applies—
- (a) must undertake remedial action to make the **metering installation**—
 - (i) accurate; and
 - (ii) not defective; and
 - (iii) fit for purpose; and
 - (b) must use its best endeavours to complete the remedial action under paragraph (a) no later than 10 **business days** after the date on which it is required to provide a report to all affected **participants** under clause 10.43(4)(c).”

Clause 10.46(A): inserted, on 1 February 2021, by clause 16 of the Electricity Industry Participation Code Amendment (Metering and Related Registry Processes) 2020.

10.47 ATH to keep records of modifications to correct defects and inaccuracies in metering installation

An **ATH** must, when taking action to remedy an inaccuracy or defect within a **metering installation**, ensure that records of any modifications that are carried out to the **metering installation** are kept for each **metering component** of the **metering installation** in the **metering records** and in a manner reasonable in the circumstances to ensure that further investigation can be carried out.

Clause 10.47 Heading: amended, on 1 February 2021, by clause 17 of the Electricity Industry Participation Code Amendment (Metering and Related Registry Processes) 2020.

10.48 Correction of defects and inaccuracies in raw meter data

- (1) A **participant** may, within 40 **business days** of receiving a statement of situation under clause 10.46(2), advise the **metering equipment provider** of any questions, or requests for clarification, it has in relation to the corrections needed to the **raw meter data** from the **metering installation**.
- (2) A **metering equipment provider** must, within 10 **business days** of being advised under subclause (1), respond in detail to the questions or requests for clarification.
- (3) A **metering equipment provider** must, within 10 **business days** of being advised under subclause (1), advise the **reconciliation participant** responsible for providing **submission information** for the **point of connection**, of the correction factors referred to in clause 10.46(1)(h) and the period referred to clause 10.46(1)(i).
- (4) The **reconciliation participant** must apply the correction factors advised under subclause (3), for the period advised under subclause (3), to the **raw meter data** to obtain more accurate information as required under clause 15.12.

NSP table

10.49 NSP table

- (1) The **Authority** must **publish** an **NSP table**.
- (2) The **reconciliation manager** must advise the **Authority** of any change to the information contained in the **NSP table** within 1 **business day** of becoming aware of such change.
- (3) The **Authority** must update the **NSP table** within 2 **business days** of being advised by the **reconciliation manager** under subclause (2).

Clause 10.49(1): replaced, on 5 October 2017, by clause 179(1) of the Electricity Industry Participation Code Amendment (Code Review Programme) 2017.

Clause 10.49(2) and (3): amended, on 5 October 2017, by clause 179(2) of the Electricity Industry Participation Code Amendment (Code Review Programme) 2017.

Dispute resolution

10.50 Dispute resolution

- (1) A **participant** must, in good faith, use its best endeavours to resolve any dispute with any other person about a matter dealt with in this Part.
- (2) A **participant** may refer any dispute or failure to reach agreement within the required timeframe in this Part to the **Authority** for determination.
- (3) If a complaint is not resolved under subclause (1), or by determination of the **Authority** under subclause (2), the **Authority** or a **participant** may refer the complaint to the **Rulings Panel** in accordance with subpart 4 of Part 2 of the **Act** and the regulations.
- (4) When determining a dispute, or failure to reach agreement, under subclause (2), the **Authority** must do so in a way that—
 - (a) is consultative with the parties involved; and
 - (b) encourages the parties, where possible, to work together on matters that are agreed; and
 - (c) takes into account the costs to be borne by, and the benefits that would accrue to, the **participants** involved; and
 - (d) maximises the use of informal means to resolve the dispute or conclude an agreement.
- (5) The existence of a dispute or failure to reach agreement does not excuse a **participant** from complying with this Code.
- (6) A **participant's** obligations in this clause are subject to the **Act** and the regulations.

Clause 10.50(3): amended, on 20 December 2021, by clause 28(1) of the Electricity Industry Participation Code Amendment (Code Review Programme) 2019.

Clause 10.50(6): amended, on 20 December 2021, by clause 28(2) of the Electricity Industry Participation Code Amendment (Code Review Programme) 2019.

Transitional provisions

10.51 Transitional provisions

- (1) In this clause—
 - (a) Part 10 means Part 10 of the Code that was effective prior to 29 August 2013; and
 - (b) reference to a COP means a **code of practice** under Part 10.
- (2) The intent of this clause is—
 - (a) as far as practicable, to preserve the effect of Part 10, prior to 29 August 2013; and
 - (b) to clarify that a breach of Part 10 will subsist as a breach of the Code, despite the coming into force of this Part; and
 - (c) to clarify that disputes and complaints about breaches under Part 10 must be resolved under this Part, and to provide the procedure to ensure that will happen; and
 - (d) to clarify that certain exemptions, authorisations, and **code of practice** 10.5 variations under Part 10 will remain in force in accordance with their terms, as if they had been made under this Part; and

- (e) to clarify the effect of certain contractual arrangements after this Part comes into force; and
 - (f) to clarify the effect of a **participant** being in compliance with certain of the provisions in Part 10, after this Part comes into force.
- (3) A **certification**, as at 28 August 2013, of—
- (a) a **metering installation**—
 - (i) as a **category 1 metering installation** that had interim **certification** under Part 10, continues under this Part until 1 April 2015; and
 - (ii) as a category 6 **metering installation**, continues as a category 5 **metering installation** and otherwise in accordance with the terms of the **certification**; and
 - (iii) as any other category, continues under this Part in accordance with the terms of the **certification**; and
 - (b) a **metering component** continues under this Part in accordance with the terms of the **certification**.
- (4) An **audit** that was carried out under the Code by an **auditor**, that was completed, immediately prior to 29 August 2013, continues to have the effect and status of an **audit** under this Part.
- (5) The following persons **certified** and approved by the Electricity Commission or the **Authority**, under the Code, immediately prior to 29 August 2013, remain, for all purposes of this Part, **certified** and approved by the **Authority**, in accordance with the terms and scope of the relevant **certification** and approval as if such **certification** and approval had been issued under this Part:
- (a) an **auditor**; and
 - (b) an **approved test house**, which will be approved as an **ATH** under this Part.
- (6) The following continue in effect despite anything else in, or the coming into force of, this Part, to the extent that they relate to or concern the same, or similar, obligations under this Part, and will apply to a **participant's** obligations under or compliance with, the relevant obligation under this Part:
- (a) an approval for an alternative quality management system previously issued under clauses 4(4) and 6(12) of COP 10.2:
 - (b) an approval for an alternative standard previously issued under clause 3(4) of COP 10.2 and clause 2 of COP 10.2 and 10.3:
 - (c) a variation under clause 3(15) or 4(7) to 4(9) of COP 10.3:
 - (d) a temporary **certification** under clause 9(17) of COP 10.3:
 - (e) an alternative standard that an **approved test house** has used in the **certification** of a **metering installation** under clause 2 of COP 10.3 and clause 2 of COP 10.4:
 - (f) a variation approved by the market administrator under COP 10.5:
 - (g) a statistical sampling process under clause 5(18) of COP 10.3:
 - (h) an exemption under section 11 of the **Act**.
- (7) An **ATH** must, if it has **certified a metering installation** using an alternative standard referred to in subclause (6)(e), in accordance with Part 10, advise the **Authority** of that alternative standard within 3 **business days** of 29 August 2013.
- (8) The following continue in effect, despite anything else in, or the coming into force of,

- this Part, to the extent that they relate to or concern the same, or similar, obligations under this Part, and apply to a **participant's** obligations under or compliance with, the relevant obligation under this Part:
- (a) **calibration** intervals referred to in clause 6(1) of COP 10.2; and
 - (b) the maximum intervals between inspections referred to in clause 9(2) of COP 10.3, provided that if the date by which the next inspection would, under this Part, be later, then such later date will apply.
- (9) Despite anything else in, or the coming into force of, this Part—
- (a) clause 10.4 and clauses 10.12 to 10.15 of Part 10 continue to apply insofar as they relate to all **raw meter data interrogated** and processed under Part 10, on which **submission information** is based that is still subject to the reconciliation process under Part 15, until the reconciliation process for the **submission information** has been concluded in accordance with Part 15; and
 - (b) clauses 10.7(b) and (c) of Part 10 continue to apply in relation to all **raw meter data** recorded before 29 August 2013; and
 - (c) an **approved test house's** obligations under clauses 5(16) and 5(17) of COP 10.2 and clause 4(12) of COP 10.3 will continue in accordance with their terms in relation to all records created before 29 August 2013.
- (10) If a **participant** is a party to an arrangement, assignment, or contract (including an agency agreement) previously entered into under clauses 10.2, 10.3, or 10.6 of Part 10 in relation to a **participant's** responsibilities under Part 10 and a provision in that arrangement, assignment, or contract is inconsistent with this Part, the provision ceases to be effective from 29 August 2013, but this is without prejudice to any existing disputes under such arrangements, assignments, or contracts, that must be resolved between the relevant persons concerned in accordance with the arrangement, assignment, or contract as if it remained effective.
- (11) Despite anything else in, or the coming into force of, this Part—
- (a) any dispute concerning a **metering installation, metering data, raw meter data,** and all related matters that were in existence immediately before 29 August 2013,—
 - (i) remain in existence; and
 - (ii) may be resolved under clause 10.50; and
 - (b) any breaches or alleged breaches of Part 10, and investigations of rule breaches or alleged rule breaches under Part 10, are unaffected and must be concluded as if the relevant provisions alleged to have been breached, under Part 10, and the relevant Part 10 definitions remain in force; and
 - (c) any rule breaches or alleged rule breaches described in paragraph (b) will be dealt with by the **Authority** and the **Rulings Panel** under clause 10.50 and the **Act**.
- (12) Despite anything else in, or the coming into force of, this Part, subclause (13) applies to a **participant** who was immediately prior to 29 August 2013 responsible under Part 10 for—
- (a) measuring the quantity of **electricity** at any **metering installation**; or
 - (b) estimating the quantity of **unmetered load**.
- (13) A **participant** described in subclause (12), who is responsible for **volume information**

which has not, at 29 August 2013, been submitted to the **reconciliation manager** in accordance with Part 15 must complete the submission of the **volume information** to the **reconciliation manager** in accordance with Part 10, as if that Part remained effective.

- (14) Despite anything else in, or the coming into force of, this Part, a **participant** who is responsible for a **metering installation** under Part 10, immediately prior to 29 August 2013 must remain in compliance with—
- (a) clauses 10.7(b) and 10.7(c) of Part 10, in respect of **raw meter data** kept before 29 August 2013, and does not breach any of the corresponding obligations in this Part, provided that the **participant** keeps the **raw meter data** in compliance with clauses 10.7(b) and 10.7(c) of Part 10; and
 - (b) clause 10 of COP 10.3, in respect of records kept before 29 August 2013, and does not breach any of the corresponding obligations in this Part, provided that the **participant** keeps the records in compliance with rule 10 of COP 10.3.
- (15) The following procedures commenced before, but not completed by, 29 August 2013 are not valid unless they are completed in compliance with this Part:
- (a) **metering installation** tests; and
 - (b) **audits** of an **approved test house** under Part 10 (which must be completed as an **audit** of an **ATH** under this Part).
- (16) The obligations of a **metering equipment provider** expressed in this Part as applying in relation to arranging **certification** of a **metering installation** or a **metering component** after 29 August 2013 do not apply to—
- (a) a **metering installation** referred to in subclause (3)(a):
 - (b) a **metering component** referred to in subclause 3(b).

Clause 10.51: amended, on 29 August 2013, by clause 25 of the Electricity Industry Participation (Metering Arrangements) Code Amendment 2011, Amendment 2013 (No 2).

Clause 10.51(6)(f): amended, on 5 October 2017, by clause 180 of the Electricity Industry Participation Code Amendment (Code Review Programme) 2017.

**Schedule 10.1
Tables**

cls 10.37 and 10.43

Table 1: Metering installation characteristics and associated requirements

Defining Characteristics				Associated Requirements of active energy metering							
Metering installation category	Primary voltage (V)	Primary current (I)	Measuring transformers	Metering installation certification type	Maximum meter class for installation category	Accuracy tolerances		Selected component metering installation minimum IEC class (more accurate components may be used)		Metering installation certification and inspection	
						Maximum permitted error	Maximum site uncertainty	Meter	Current Transformer	Maximum metering installation certification validity period	Maximum inspection period
1	V < 1kV	I ≤ 160A	None	NHH or HHR	Class 2.0	± 2.5%	0.6%	2	N/A	180 months	126 months
2	V < 1kV	I ≤ 500A	CT and where applicable, VT	NHH or HHR	Class 2.0	± 2.5%	0.6%	2	1	120 months	126 months
3	V < 1kV	500A < I ≤ 1200A	CT	HHR only	Class 1.0	± 1.25%	0.3%	1	0.5	120 months	63 months
	V < 1kV	500A < I ≤ 1200A	VT & CT		Class 0.5			N/A	N/A		
	1kV ≤ V ≤ 11kV	I ≤ 100A			N/A			N/A			
	11kV < V ≤ 22kV	I ≤ 50A			N/A			N/A			
4	V < 1kV	I > 1200A	CT	HHR only	Class 0.5	± 1.25%	0.3%	N/A	N/A	60 months	33 months
	V < 1kV	I > 1200A	VT & CT								
	1kV ≤ V ≤ 6.6kV	100A < I ≤ 400A									
	6.6kV < V ≤ 11kV	100A < I ≤ 200A									
	11kV < V ≤	50A < I ≤									

**Electricity Industry Participation Code 2010
Schedule 10.1**

	22kV	100A									
5	$1kV \leq V \leq 6.6kV$	$I > 400A$	VT & CT	HHR only	Class 0.2	$\pm 0.75\%$	0.2%	N/A	N/A	36 months	19 months
	$6.6kV < V \leq 11kV$	$I > 200A$									
	$V > 11kV$	$I > 100A$									
	$V > 22kV$	Any current									

Schedule 10.1, Table 1: replaced, on 1 February 2021, by clause 18 of the Electricity Industry Participation Code Amendment (Metering and Related Registry Processes) 2020.

Table 2: *[Revoked]*

Schedule 10.1, Table 2: revoked, on 1 February 2021, by clause 19 of the Electricity Industry Participation Code Amendment (Metering and Related Registry Processes) 2020.

Table 3: Selected component certification and comparative recertification minimum test requirements

	Event	Design check	Prevailing load test	Data storage device check	Software security and communication equipment check	Control device check	Wiring check	Component certification check	Review of compensation factors	Raw meter data output test	Supply polarity check	Register advance test	Installation or component configuration check
Category 1 metering installations	Initial certification, or recertification with all meters replaced	M			M	MI	M	M	M	M	M	M	M
	Recertification with no meters replaced	M	M		M	MI	M	M	M	M	M	M	M
	Recertification with one or more meters replaced with a certified meter(s), at least one existing meter remains, and metering installation expiry date is not changed	M			M	MI	M	M	M	M	M	M	M
	Recertification with one or more meters replaced with a certified meter(s), at least one existing meter remains (which must have calibration that is valid for the new certification period), and metering installation expiry date is changed	M	M		M	MI	M	M	M	M	M	M	M
Categories 2 – 3	Initial certification, recertification, or meter change including internal data storage devices	M	M	MI (for Cat 3 only)	M	MI	M	M	M	M	M	M	M

**Electricity Industry Participation Code 2010
Schedule 10.1**

	Measuring transformer change or ratio change	M	M				M	M	M	M	M	M	M
Categories 1-3	Metrology software change either onsite or remote	M		M	M			M	M	M		M	M
	External data storage device change	M		M	M		M	M	M	M		M	M
	Control device change	M		MI		M	M	M		M			M
	Additional equipment (eg wiring)	M	M				M			M	M	M	M

Key: **M** = mandatory, **MI** = mandatory if installed.

Table 3: rows 6 and 8 amended, on 15 May 2014, by clause 14 of the Electricity Industry Participation (Minor Code Amendments) Code Amendment 2014.

Table 3: row 3 amended, on 19 December 2014, by clause 21 of the Electricity Industry Participation Code Amendment (Minor Code Amendments) (No 3) 2014.

Table 3: replaced, on 1 February 2021, by clause 20 of the Electricity Industry Participation Code Amendment (Metering and Related Registry Processes) 2020.

Electricity Industry Participation Code 2010
Schedule 10.1

Table 4: Fully calibrated certification minimum test requirements

Event		Design	Measuring transformer	Meter	Primary injection to meter	Prevailing load	Data storage device	Software security and communication equipment	Control device	Wiring check	Component certification check	Review of compensation factors	Raw meter data output	Supply polarity	Register advance	Installation or component configuration
Metering installation	Initial certification	M	M	M	T	M	M	M	M	M	M	M	M	M	M	M
	Recertification	M		M		M	M	M	M	M	M	M	M	M	M	M
	Meter change including internal data storage device	M		M		M	M	M		M		M	M	M	M	M
	Metrology change either onsite or remote	M		M			M	M				M	M		M	M
Component change or recertification	External data storage device change	M					M	M		M		M	M		M	M
	Measuring transformer change or ratio change	M	M		T	M				M		M	M	M	M	
	Control device change	M					MI		M	M			M			M
	Additional equipment (eg wiring)	M			T	M				M			M	M	M	
	Initial certification	M	M	M	T	M	M	M	M	M	M	M	M	M	M	M
	Recertification	M		M		M	M	M	M	M	M	M	M	M	M	M

Key: M = mandatory, T = mandatory if test method and test equipment permit, MI = mandatory if the control device is integral with the meter.

Table 5: Standards for metering components

Meter and data storage device standards	Standards
Electricity metering equipment (AC) – Part 1: General requirements, tests and test conditions (classes 0.5, 1 and 2)	EN 50470-1
Electricity metering equipment (AC) – Part 2: Particular requirements – Electromechanical meters for active energy (classes 1 and 2)	EN 50470-2
Electricity metering equipment (AC) – Part 3: Particular requirements – Static meters for active energy (classes 0.5, 1 and 2)	EN 50470-3
Electricity metering equipment (AC) – Particular requirements – Part 11: Electromechanical meters for active energy (classes 0.5, 1 and 2)	IEC 62053-11
Electricity metering equipment (AC) – Particular requirements – Part 21: Static meters for active energy (classes 1 and 2)	IEC 62053-21
Electricity metering equipment (AC) – Particular requirements – Part 22: Static meters for active energy (classes 0.2 S and 0.5 S)	IEC 62053-22
Electricity metering equipment (AC) – Particular requirements – Part 23: Static meters for reactive energy (classes 2 and 3)	IEC 62053-23
Electricity metering equipment (AC) – Particular requirements – Part 61: Power consumption and voltage requirements	IEC 62053-61
Electricity metering equipment (AC) – General requirements, tests and test conditions – Part 11: Metering equipment	IEC 62052-11
Measuring transformer standards	
Instrument transformers – Part 1: Current transformers	IEC 60044-1
Instrument transformers – Part 2: Inductive voltage transformers	IEC 60044-2
Instrument transformers – Part 3: Combined transformers	IEC 60044-3
Instrument transformers – Part 5: Capacitor voltage transformers	IEC 60044-5
Coupling capacitors and capacitor dividers	IEC 60358
Instrument transformers – Part 7: Electronic voltage transformers	IEC 60044-7
Instrument transformers – Part 8: Electronic current transformers	IEC 60044-8
Other standards	
Electricity metering equipment (AC) – Tariff and load control – Part 11: Particular requirements for electronic ripple control receivers	IEC 62054-11
Electricity metering equipment (AC) – Tariff and load control – Part 21: Particular requirements for time switches	IEC 62054-21

Table 5: row 1 amended, on 15 May 2014, by clause 15 of the Electricity Industry Participation (Minor Code Amendments) Code Amendment 2014.

Table 6: Standards of accuracy and overall uncertainty for active and reactive meter calibration and testing

Value of Current %	Power Factor	Maximum Overall Uncertainty %	Percentage Error Limits of Meter, Including Uncertainty
Class of meter 2.0 and 2.0S			
5 to 120	1	±0.4	±1.9
10 to 120	0.5 lagging	±0.6	±1.9
10 to 120	0.8 leading	±0.6	±1.9
Class of meter 1.0 and 1.0S			
5 to 120	1	±0.2	±0.9
10 to 120	0.5 lagging	±0.25	±0.9
10 to 120	0.8 leading	±0.25	±0.9
Class of meter 0.5 and 0.5S			
5 to 120	1	±0.1	±0.5
10 to 120	0.5 lagging	±0.12	±0.6
10 to 120	0.8 leading	±0.12	±0.6
Class of meter 0.2S			
5 to 120	1	±0.06	±0.2
10 to 120	0.5 lagging	±0.09	±0.3
10 to 120	0.8 leading	±0.09	±0.3
Class of meter 3.0 reactive			
20 to 120	Zero	±1.0	±3.0
20 to 120	0.8 leading	±1.5	±3.5
20 to 120	0.8 lagging	±1.5	±3.5
Class of meter 2.0 reactive			
20 to 120	Zero	±0.5	±2.0
20 to 120	0.8 leading	±1.0	±2.5
20 to 120	0.8 lagging	±1.0	±2.5

Table 7: Voltage, current, and phase displacement parameters for polyphase meters

Polyphase meters	Class of meter			
	0.2 and 0.5	1.0	2.0	3.0
Each of the voltages between line and neutral or between any 2 lines will not differ from the average corresponding voltage by more than:	±0.1%	±1.0%	±1.0%	±1.0%
Each of the currents in the conductors will not differ from the average current by more than:	±1.0%	±2.0%	±2.0%	±2.0%
The phase displacements of each of these currents from the corresponding line-to-neutral voltage, irrespective of the power factor, will not differ from each other by more than:	2°	2°	2°	2°

Schedule 10.1, Table 7: amended, on 1 February 2016, by clause 30 of the Electricity Industry Participation Code Amendment (Code Review Programme) 2015.

Table 8: Required minimum sample size for category 1 metering installation inspections required under clause 45(2)(c) of Schedule 10.7

Number of metering installations identified	Minimum sample size
1	1
2-8	2
9-15	3
16-25	5
26-50	8
51-90	13
91-150	20
151-280	32
281-500	50
501-1200	80
1201-3200	125
3201-10,000	200
10,001-35,000	315
35,001-150,000	500
150,001+	800

Schedule 10.2
[Revoked]

cl 10.17

Schedule 10.2: revoked, on 1 June 2017, by clause 10 of the Electricity Industry Participation Code Amendment (Requirements and Processes for Audits) 2016.

Schedule 10.3

cl 10.40

ATHs – approval, expiry, cancellation, and renewal of approval

1 Applications for approval and renewal of approval

- (1) A person wishing to be approved as an **ATH**, or an **ATH** wishing to renew its approval, must apply, in the **prescribed form**, to the **Authority** at least 2 months before the intended effective date of the approval or renewal.
- (2) An applicant must—
 - (a) include in its application—
 - (i) the final **audit** report obtained under Part 16A, together with its responses to the report; and
 - (ii) a copy of any quality management certificates it holds; and
 - (iii) a copy of its most recent quality management audit report; and
 - (iv) the class of **ATH** for which it is seeking approval; and
 - (v) the functions under clauses 3(2) and 4(2) for which it is seeking approval; and
 - (vi) the **calibration** expiry date of each of its **working standards** and **reference standards**; and
 - (b) provide promptly any other information or documentation the **Authority** may reasonably request.
- (3) The **Authority** must, within 2 months of receiving an application, advise the applicant of—
 - (a) the approval of the application, if the applicant satisfies the **Authority** that it has met the requirements set out in clause 10.40; or
 - (b) the declination of the application, providing reasons, if the **Authority** considers that—
 - (i) the information supplied by the applicant is incomplete or unsatisfactory; or
 - (ii) the applicant otherwise fails to demonstrate that it would be, and would remain for the period and functions for which the application is made, compliant with the requirements set out in clause 10.40.
- (4) If an application is approved, the **Authority** must issue a certificate of approval specifying the—
 - (a) period of the term of approval, which must not exceed 12 months from the date of approval; and
 - (b) functions that the applicant has been approved to carry out; and
 - (c) *[Revoked]*
 - (d) date of approval.

Clause 1(2)(a)(i): amended, on 1 June 2017, by clause 11(1) of the Electricity Industry Participation Code Amendment (Requirements and Processes for Audits) 2016.

Clause 1(4)(a): amended, on 5 October 2017, by clause 181 of the Electricity Industry Participation Code Amendment (Code Review Programme) 2017.

Clause 1(4)(c): revoked, on 1 June 2017, by clause 11(2) of the Electricity Industry Participation Code Amendment (Requirements and Processes for Audits) 2016.

2 *[Revoked]*

Clause 2: revoked, on 1 June 2017, by clause 12 of the Electricity Industry Participation Code Amendment (Requirements and Processes for Audits) 2016.

3 Approval of class A ATHs

- (1) An applicant applying for approval, or renewal of approval, as a **class A ATH** must, as part of its application, confirm that—
- (a) it holds and complies with AS/NZS ISO 17025 accreditation, for at least the requested term of the approval; and
 - (b) the scope of its AS/NZS ISO 17025 accreditation covers the activities that it undertakes, or proposes to undertake; and
 - (c) it complies, and will be likely to continue to comply during the requested term of the approval, with any requirements of its ISO accreditation; and
 - (d) if it proposes to carry out field work—
 - (i) it is certified to the relevant AS/NZS ISO 9001:2008 or AS/NZS ISO 9001:2016 and will remain certified during the requested term of the approval; and
 - (ii) the scope of its AS/NZS ISO 17025 accreditation has been extended to cover the carrying out of the field work.
- (2) The **Authority** may approve an applicant to be, or renew an applicant's approval as, a **class A ATH** to carry out 1 or more of the following functions:
- (a) **calibration** of—
 - (i) **working standards**;
 - (ii) **metering components** (other than a **calibration** referred to in paragraph (c));
 - (iii) **metering installations**;
 - (b) issuing **calibration reports**;
 - (c) **calibration** of **metering components** onsite;
 - (d) installation and modification of **metering installations**;
 - (e) installation and modification of **metering components**;
 - (f) **certification** of all categories of **metering installations** under this Code, and issuing of **certification reports**;
 - (g) testing of **metering installations** under clause 10.44 and production of statements of situation under clause 10.46;
 - (h) inspection of **metering installations**.
- (3) A **class A ATH** may only carry out 1 or more of the functions listed in subclause (2), subject to—
- (a) the current scope of its approval under subclause (2); and
 - (b) any limitations that may be specified in the **class A ATH's** AS/NZS ISO 17025 accreditation or the relevant AS/NZS ISO 9001:2008 or AS/NZS ISO 9001:2016 certification.
- (4) The **Authority** may decline an application for approval as a **class A ATH** even if the applicant—
- (a) has obtained the necessary ISO accreditation or certification; or

(b) has obtained or satisfied any other pre-requisite to approval.

Clause 3(1)(b): amended, on 29 August 2013, by clause 26 of the Electricity Industry Participation (Metering Arrangements) Code Amendment 2011, Amendment 2013 (No 2).

Clause 3(1)(d)(i) and 3(3)(b) amended, on 1 June 2017, by clause 13 of the Electricity Industry Participation Code Amendment (Requirements and Processes for Audits) 2016.

4 Approval of class B ATHs

- (1) An applicant applying for approval, or renewal of approval, as a **class B ATH** must, as part of its application to the **Authority**, confirm that—
- (a) it holds and complies with AS/NZS ISO 9001:2016 certification for at least the term of the requested approval; and
 - (b) the scope of its AS/NZS ISO 9001:2016 certification covers the activities that it undertakes, or proposes to undertake; and
 - (c) it will develop and at all times during the term of the requested approval maintain a conflict of interest policy in compliance with AS/NZS ISO 17025.
- (1A) Despite subclause (1), an applicant may apply to the **Authority** for approval as a **class B ATH** without confirming that it holds and complies with AS/NZS ISO 9001:2016 certification for at least the term of the requested approval, provided the applicant confirms as part of its application that—
- (a) it holds and complies with AS/NZS ISO 9001:2016 certification at the time of the application and that certification expires during the approval period; and
 - (b) it has in place appropriate plans to ensure that it renews its AS/NZS ISO 9001:2016 certification for the term of the requested approval, so that its AS/NZS ISO 9001:2016 certification remains in place continuously throughout the approval period.
- (2) The **Authority** may approve an applicant to be, or renew an applicant's approval as, a **class B ATH** to carry out 1 or more of the following functions:
- (a) **calibration** of class 0.5 **meters**, class 1 **meters** and class 2 **meters**, and class 0.5 current transformers and class 1.0 current transformers, provided that the **calibrations** are carried out under their approved quality certification and in accordance with this Part, and included within the **ATH audit** for approval:
 - (b) installation and modification of **metering installations**:
 - (c) installation and modification of **metering components**:
 - (d) **calibration** of **metering components** onsite:
 - (e) **certification**, using the **selected component certification** method, of—
 - (i) **category 1 metering installations**:
 - (ii) **category 2 metering installations**:
 - (iii) category 3 **metering installations** with a primary voltage of less than 1kV:
 - (f) **certification**, using the **fully calibrated certification** method, of—
 - (i) **category 1 metering installations**:
 - (ii) **category 2 metering installations**:
 - (iii) category 3 **metering installations** with a primary voltage of less than 1kV:
 - (g) **certification**, using the **comparative recertification** method, of **category 2 metering installations**:
 - (h) issuing of **certification reports** in respect of **certifications** of **metering**

- installations** under paragraphs (e) to (g):
- (i) inspection of—
 - (i) **category 1 metering installations:**
 - (ii) **category 2 metering installations:**
 - (iii) **category 3 metering installations** with a primary voltage of less than 1kV.
 - (3) A **class B ATH** may only carry out 1 or more of the functions listed in subclause (2), subject to—
 - (a) the current scope of its approval under subclause (2); and
 - (b) any limitations that may be specified in the relevant AS/NZS ISO 9001:2008 or AS/NZS ISO 9001:2016 certification.
 - (4) The **Authority** may decline an application for approval as a **class B ATH** even if the applicant—
 - (a) has obtained the necessary ISO certification; or
 - (b) has obtained or satisfied any other pre-requisite to approval.
- Clause 4(1)(a) and (b) amended, on 1 June 2017, by clause 14 of the Electricity Industry Participation Code Amendment (Requirements and Processes for Audits) 2016.
Clause 4(1)(b): amended, on 29 August 2013, by clause 27 of the Electricity Industry Participation (Metering Arrangements) Code Amendment 2011, Amendment 2013 (No 2).
Clause 4(1)(a), (b) and (c): amended, on 1 February 2021, by clause 21(1)(a) and (b) of the Electricity Industry Participation Code Amendment (Metering and Related Registry Processes) 2020.
Clause 4(1A): inserted, on 1 February 2021, by clause 21(2) of the Electricity Industry Participation Code Amendment (Metering and Related Registry Processes) 2020.
Clause 4(3)(b) amended, on 1 June 2017, by clause 14 of the Electricity Industry Participation Code Amendment (Requirements and Processes for Audits) 2016.

4A Incorporation of AS/NZS ISO 9001:2008 and AS/NZS ISO 9001:2016 by reference

- (1) The New Zealand Standards AS/NZS ISO 9001:2008 and AS/NZS ISO 9001:2016 are incorporated by reference in this Code.
 - (2) *[Revoked]*
 - (3) *[Revoked]*
- Clause 4A inserted, on 1 June 2017, by clause 15 of the Electricity Industry Participation Code Amendment (Requirements and Processes for Audits) 2016.
Clause 4A(1): amended, on 1 August 2023, by clause 40(1) of the Electricity Industry Participation Code Amendment (System Operation Documents) 2023.
Clauses 4A(2) and 4A(3): revoked, on 1 August 2023, by clause 40(2) and 40(3) of the Electricity Industry Participation Code Amendment (System Operation Documents) 2023.

5 Expiry and cancellation of approval

- (1) If the **Authority** believes that an **ATH** is or was in breach of this Part the **Authority** may cancel the approval of the **ATH** with immediate effect by advising the **ATH**.
- (2) An **ATH** must not, at any time after the expiry or cancellation of its approval, display or use its certificate of approval.

6 Changes that affect approval

- (1) If an **ATH** intends to make a material change to any of its facilities, processes, or procedures, or the scope of the **ATH's** ISO accreditation is reduced during the term of its approval, the **ATH** must, at least 5 **business days** before the change is to take place or reduction in scope is effected,—
 - (a) advise the **Authority** of all relevant details of the change or reduction in scope;

and

- (b) in the case of a material change, submit to the **Authority** an **audit** report confirming that, after the change has come into effect, the **ATH** will continue to meet the requirements under clause 10.40(2)(a).
- (2) An **ATH's** approval is automatically cancelled from the date of the change or reduction in scope under subclause (1), if the **ATH** fails to advise the **Authority** under subclause (1)(a).
- (3) The **Authority** may, if it is advised by an **ATH** under subclause (1), either—
 - (a) cancel an **ATH's** approval from the date that the **Authority** advises the **ATH** that the **Authority** is not satisfied that the **ATH** will continue to meet the requirements under clause 10.40(2)(a) after the change or reduction in scope has come into effect; or
 - (b) revise the scope of the **ATH's** approval.

7 Notice of cancellation, expiry, or revision of scope of ATH approval

- (1) The **Authority** must give written notice to all **metering equipment providers** if—
 - (a) an **ATH's** approval expires and the **Authority** does not renew it;
 - (b) the **Authority** cancels an **ATH's** approval under clause 5;
 - (c) an **ATH's** approval is cancelled under clause 6(2) or 6(3)(a);
 - (d) the scope of an **ATH's** approval has been revised under clause 6(3)(b).
- (2) The **Authority** must include with the notice under subclause (1) the date on which the approval expired or was cancelled, or the scope of the approval was revised.
- (3) A **metering equipment provider** given notice under subclause (1) must treat all **metering installations certified** by the **ATH** during the period during which it was not validly approved, or was performing activities outside its scope of approval, as being defective from the date of which the **Authority** gave notice under subclause (2) and follow the procedures set out in clauses 10.43 to 10.48.
- (4) Despite subclause (3), the **Authority** may give a **metering equipment provider** written notice that the **metering equipment provider** must treat a **metering installation certified** by the **ATH** as being defective and follow the procedures set out in clauses 10.43 to 10.48.

Clause 7 Heading: amended, on 1 November 2018, by clause 29 of the Electricity Industry Participation Code Amendment (Code Review Programme) 2018.

Clause 7: amended, on 5 October 2017, by clause 182 of the Electricity Industry Participation Code Amendment (Code Review Programme) 2017.

8 Register of ATHs

- (1) The **Authority** must, keep, maintain, and **publish** a register of approved **ATHs**.
- (2) The **Authority** must remove an **ATH's** details from the register if the **ATH's** approval—
 - (a) expires and the **Authority** does not renew it; or
 - (b) is cancelled.

Schedule 10.4 ATH ongoing functions and obligations

cl 10.42

1 Accommodation and environment

An **ATH** must, for each **approved test house** that it operates,—

- (a) maintain a list of personnel who are authorised to access and use its laboratory and storage facilities; and
- (b) restrict access to its laboratory and storage facilities to—
 - (i) the personnel specified under paragraph (a); and
 - (ii) the **Authority**; and
 - (iii) an **auditor** conducting an **audit**; and
 - (iv) any other person who is, at all times, directly supervised by a member of personnel specified under paragraph (a); and
- (c) restrict access to its **metering records** to—
 - (i) the relevant **metering equipment provider**;
 - (ii) the **Authority**;
 - (iii) an **auditor** conducting an **audit**;
 - (iv) the relevant **metering component** owner; and
- (d) ensure that the environment in which its activities are undertaken does not, or could not reasonably be expected to, invalidate test results or adversely affect the required accuracy of measurement; and
- (e) monitor and record the environmental conditions within its **approved test house's** laboratory and storage facilities; and
- (f) comply with the specific requirements of the applicable standard listed in Table 5 of Schedule 10.1 for the **calibrations** or tests being carried out.

Clause 1(c)(iv): amended, on 29 August 2013, by clause 28 of the Electricity Industry Participation (Metering Arrangements) Code Amendment 2011, Amendment 2013 (No 2).

2 Equipment

- (1) An **ATH** must, at all times, ensure that—
 - (a) it has access to all items of equipment required for the performance of the **calibrations** and tests it is approved to undertake under this Part; and
 - (b) each item of equipment it uses is maintained in accordance with the manufacturer's recommendations and this Code (but if there is any inconsistency or contradiction between the manufacturer's recommendations and this Code, this Code takes precedence); and
 - (c) it maintains records about each item of its equipment, including—
 - (i) details of—
 - (A) maintenance history; and
 - (B) the **ATH's** maintenance programme; and
 - (ii) **calibration reports**, including before and after **adjustment** results; and
 - (iii) in-service checks; and
 - (iv) a history of any damage, malfunction, modification, or repair.

- (2) A **class B ATH** must have and maintain procedures for the purchase of test equipment and associated consumables.

3 Reference standards and working standards

- (1) An **ATH** must not use a **reference standard** or **working standard** for any activity regulated under this Part unless—
- (a) in the case of—
- (i) a **reference standard**, the **reference standard** has been **calibrated** by an **approved calibration laboratory**; or
 - (ii) a **working standard**, the **working standard** has been **calibrated** by an **approved calibration laboratory** or a **class A ATH**; and
- (b) the current **calibration report** for the **reference standard** or **working standard** confirms that it—
- (i) performs within the manufacturer’s accuracy specifications; and
 - (ii) has been **calibrated** under subclause (2) at an interval not exceeding the **calibration** intervals set out in the following table.

Table 1: Calibration intervals

Standard		Initial calibration interval (months beginning from the date of the first calibration)	Maximum calibration interval (months beginning from the date of the current calibration report)
Reference standard or working standard (other than a working standard used for on-site calibration)	Measuring transformers	36	60
	Comparator bridges	36	60
	Meters	12	24
	Power factor, voltage and current meters	12	24
Working standard used for on-site calibration	All	2	12

- (2) An **ATH** must ensure that a **reference standard** or **working standard** is **calibrated**—
- (a) for the first time, within the applicable initial **calibration** interval set out in Table 1 of subclause (1); and
- (b) for each subsequent **calibration**, within the applicable maximum **calibration** interval set out in Table 1 of subclause (1).

- (3) A **class A ATH** must ensure that—
 - (a) in all cases of **calibration** of its **reference standards**, the **uncertainties** given in the **reference standard calibration report** are sufficiently small so that the overall **uncertainty** in the measurements used to test a **metering installation** does not exceed one third of the maximum permitted error set out in Table 1 of Schedule 10.1 for the category of **metering installation** that the **reference standard** will be used to **calibrate**; and
 - (b) it does not use a **working standard** on a system operating at a voltage of 33kV or above between active conductors, unless the **working standard** has been **calibrated** by an **approved calibration laboratory**; and
 - (c) it does not use a **reference standard**, other than a standard **measuring transformer**, unless it is maintained at the appropriate reference conditions set out in the **reference standard's current calibration report**.
- (4) If appropriate reference conditions under subclause (3)(c) cannot be achieved, the **class A ATH** must calculate and apply adjustments in accordance with the processes and procedures under subclause (5) so that the **reference standard** achieves the errors and uncertainties set out in the **reference standard's current calibration report**.
- (5) An **ATH** must develop and maintain processes and procedures for calculating and applying adjustments to a **reference standard's** errors and uncertainties to compensate for deviations from the reference conditions contained in the **reference standard's current calibration report**.
- (6) An **ATH** must retain a copy of the current **calibration report** for each of its **reference standards** and **working standards**.

4 Metering component testing systems

An **ATH** may use a complete **calibrated metering component** testing system (also known as a test bench) as an alternative to a separately **calibrated working standard** only if—

- (a) the **ATH calibrates** the complete **calibrated metering component** testing system under clause 3 as if it was a **working standard**; and
- (b) before completing the **calibration report**, the **ATH** carries out a testing system accuracy test, using approved **reference standards**.

5 Calibration errors

- (1) For the purposes of this clause, a **reference standard** or **working standard** has a **calibration error** if it is performing outside of the manufacturer's accuracy specifications.
- (2) An **ATH** must not use a **reference standard** or **working standard** for **calibration**, if it believes, or should reasonably be expected in the circumstances to believe, that the **reference standard** or **working standard** has a **calibration error**.
- (3) An **ATH** must, as soon as reasonably practicable, but no more than 3 months after becoming aware of a **calibration error**—
 - (a) investigate the error; and

- (b) ensure the cause of the error is recorded in a **calibration report**; and
 - (c) if the investigation indicates that the **reference standard** or **working standard** performs outside the manufacturer's accuracy specifications, advise each **ATH** that has used any equipment that was **calibrated** using the **reference standard** or **working standard** since the previous **calibration**, of the error.
- (4) An **ATH** must, if a **reference standard** or a **working standard** has a **calibration** error,—
- (a) treat each **metering installation** that it has **calibrated** using the **reference standard** or **working standard** as outside the applicable accuracy tolerances set out in Table 1 of Schedule 10.1; and
 - (b) comply with clause 10.43.
- (5) For the purposes of this clause, a **working standard** includes a complete **calibrated metering component** testing system referred to in clause 4.

6 Measurement traceability

An **ATH** must document, maintain, and comply with, a system that ensures, whenever it undertakes a **calibration** test or measurement,—

- (a) it keeps sufficient records to enable the **ATH** to replicate the test or measurement in every respect should the need arise; and
- (b) the results of the measurements are **traceable**.

Requirements for calibration of metering components

7 Calibration methods

- (1) An **ATH** must, before it **certifies** a **metering installation** or **metering component**, ensure that 1 of the following persons has **calibrated** the **metering components** under this Part:
- (a) an **approved calibration laboratory**; or
 - (b) an **ATH** with the appropriate approval under Schedule 10.3.
- (2) An **ATH** must, before it **certifies** a **metering component**, ensure that the **metering component** is **calibrated** or **adjusted** under—
- (a) the appropriate physical and electrical reference conditions detailed in the standard listed in Table 5 of Schedule 10.1; or
 - (b) conditions which permit the **ATH** to calculate the results and their **uncertainty** at the reference conditions detailed in the standard listed in Table 5 of Schedule 10.1.
- (3) A **class B ATH** must, when **calibrating** a **metering component**,—
- (a) follow all relevant requirements of NZ/AS ISO 17025 for **calibration**; and
 - (b) only use the relevant methodologies that have been **audited** in the **class B ATH's** most recent **audit** for approval.
- (4) If an **ATH** **calibrates** a **metering component**, it must ensure that the individual test points that it uses are—
- (a) no less than the minimum set out in the standards listed in Table 5 of Schedule 10.1; or

- (b) sufficient and appropriate in the circumstances to ensure that the **calibration** allows calculation of the **metering installation** error as set out in clause 22 of Schedule 10.7.
- (5) An **ATH** must, when **calibrating a metering component**,—
 - (a) if necessary, **adjust** and document the **error compensation**; and
 - (b) ensure that any **adjustment** carried out under paragraph (a) is appropriate to achieve an error as close as practicable to zero; and
 - (c) ensure that the **uncertainty** of measurement during the **calibration** of the **metering component** does not exceed one third of the maximum permitted error in the relevant standard listed in Table 5 of Schedule 10.1; and
 - (d) if the **metering component** is intended for a **metering installation** which is to be **certified** using the **selected component certification** method, ensure that the **ATH** records the errors of a current transformer from 5% to 120% of rated primary current.
- (6) An **ATH** must ensure that—
 - (a) it has documented instructions on the use and operation of all relevant equipment it uses for **calibration**; and
 - (b) it has documented **calibration** procedures that it must make available to, and ensure are followed by, its staff carrying out the **calibration**; and
 - (c) its **calibration** procedures are aligned with the standards listed in Table 5 of Schedule 10.1.
- (7) An **ATH**—
 - (a) may select a test point other than those specified in the relevant standard listed in Table 5 of Schedule 10.1, or at a lower burden than specified in the standard; but
 - (b) must, if it does this, document its reasons for the selection of these test points in the **calibration report**.

8 Compensation factors

An **ATH** must, if it is approved to **certify metering installations**, have a documented process for determining **compensation factors**.

9 Seals

An **ATH** must have a documented system for applying seals to a **metering installation**, that—

- (a) meets the requirements of clause 47 of Schedule 10.7; and
- (b) is appropriate in the circumstances to ensure—
 - (i) the **ATH's** ability to monitor the **metering installation's** continued integrity; and
 - (ii) the relevant **metering equipment provider** is alerted as soon as practicable to any unauthorised access to the **metering installation**.

10 Services access interface

An **ATH** must, when preparing a **metering installation certification report**,

determine, and record in the **certification report**,—

- (a) all **services access interfaces**; and
- (b) the conditions under which each **services access interface** may be used.

Clause 10: replaced, on 1 February 2021, by clause 22 of the Electricity Industry Participation Code Amendment (Metering and Related Registry Processes) 2020.

11 Certification and calibration reports

- (1) An **ATH** must, for each **metering installation** that it **certifies**, produce a **certification report** in accordance with Schedule 10.7.
- (2) An **ATH** must, for each **metering component**—
 - (a) that it **calibrates**, produce a **calibration report** in accordance with Schedule 10.8; and
 - (b) that it **certifies**, produce a **certification report** in accordance with Schedule 10.8.

12 ATH record keeping and documentation

- (1) An **ATH** must ensure it documents and maintains a record system for all records, certificates, and reports for any activity regulated under this Part.
- (2) An **ATH** must ensure that—
 - (a) all its records, certificates, and reports are stored securely; and
 - (b) each of its test records for a **metering installation** is identified by a unique identifier; and
 - (c) all of its records, certificates, and reports are sufficiently detailed to enable verification of all aspects of all tests it carries out, including the following:
 - (i) test conditions; and
 - (ii) specific test equipment used; and
 - (iii) personnel carrying out the tests.

13 Retention of ATH records relating to metering components

- (1) An **ATH** must, for each activity regulated under this Part in relation to a **metering component** that it **calibrates** or **certifies**, retain the following records relating to that **metering component** for at least 48 months after the **certification** expiry date of the **metering component**,—
 - (a) all of the **ATH**'s records, certificates, and reports; and
 - (b) all **certification reports** produced by the **ATH**; and
 - (c) all **calibration reports** produced by the **ATH**.
- (2) If an **ATH** intends to cease being an **ATH**, the **ATH** must transfer the records described in subclause (1) to the **metering equipment provider** either—
 - (a) recorded in the **registry** as being responsible for the **metering installation** where the **metering component** is installed; or
 - (b) identified in the **metering records** provided to the **reconciliation manager** under clause 10.26(7)(c) or 10.30(2)(c).

Clause 13: replaced, on 1 March 2024, by clause 38 of the Electricity Industry Participation Code Amendment (Code Review Programme) 2024.

13A Retention of ATH records relating to metering installations

- (1) An ATH must, for each activity regulated under this Part in relation to a **metering installation** that the ATH certifies, retain the following records relating to that **metering installation** for at least 48 months after the **certification** expiry date of the **metering installation**:
 - (a) all of the ATH's records, certificates, and reports:
 - (b) all **certification reports** produced by the ATH.
- (2) If an ATH intends to cease being an ATH, the ATH must transfer the records described in subclause (1) to the **metering equipment provider** either—
 - (a) recorded in the **registry** as being responsible for the **metering installation**; or
 - (b) identified in the **metering records** provided to the **reconciliation manager** under clause 10.26(7)(c) or 10.30(2)(c).

Clause 13A: inserted, on 1 March 2024, by clause 39 of the Electricity Industry Participation Code Amendment (Code Review Programme) 2024.

14 Making available of ATH records

An ATH must, within 5 **business days** of creating a record, certificate, or report for a **metering installation** that it certifies,—

- (a) send, in electronic form or such other form as may be agreed between the parties, a copy of the record, certificate, or report to the **metering equipment provider** responsible for the **metering installation**; and
- (b) ensure that the **metering equipment provider** receives the record, certificate, or report.

15 ATH organisation and management

- (1) An ATH must ensure that—
 - (a) it has managerial staff who, unless otherwise permitted in the relevant approval, all have the authority and resources needed to discharge their duties; and
 - (b) the responsibilities, authority, and functional relationships of all its personnel are fully and accurately specified and recorded in the ATH's records.
- (2) An ATH must appoint—
 - (a) a technical manager (however named) with overall responsibility for technical operations, who must have appropriate engineering qualifications and experience in the operation of an **approved test house**; and
 - (b) a quality manager (however named), with responsibility for the quality management certification and the implementation of the quality management system.
- (3) An ATH must ensure that all staff who perform or supervise work or activities regulated under this Part are technically competent, experienced, qualified, and trained for the functions they perform.

16 Quality management system

An ATH must establish, document, implement, maintain, and comply with a quality management system which records its processes and procedures to ensure compliance with this Part.

17 Field work

A **class A ATH** must, if it arranges for another person to carry out field work, ensure that person is certified to the relevant AS/NZS ISO 9001:2008 or AS/NZS ISO 9001:2016 at all times while the person carries out the work.

Clause 17 amended, on 1 June 2017, by clause 16 of the Electricity Industry Participation Code Amendment (Requirements and Processes for Audits) 2016.

Schedule 10.5

cl 10.20

[Revoked]

Schedule 10.5: revoked, on 1 June 2017, by clause 17 of the Electricity Industry Participation Code Amendment (Requirements and Processes for Audits) 2016.

Schedule 10.6

cl 10.20

Metering equipment provider ongoing obligations and functions

1 Metering equipment provider must provide access to raw meter data

- (1) A **metering equipment provider** must, within 10 **business days** of receiving a request from a **trader** with whom it has an arrangement to access **raw meter data** from a **metering installation** for which the **metering equipment provider** is responsible, give remote or onsite access at the **services access interface** to the **trader** to collect, obtain, and use **raw meter data** from the **metering installation**.
- (2) A **metering equipment provider** may, if it receives a request from a person with whom it has an arrangement, other than a **trader** under subclause (1), to access **raw meter data** from a **metering installation** for which the **metering equipment provider** is responsible, give remote or onsite access at the **services access interface** to the person to collect, obtain, and use **raw meter data** from the **metering installation**.
- (3) A **metering equipment provider** must only give access to a **trader** under subclause (1), or a person under subclause (2), if the **trader** or person has entered into a contract to collect, obtain, and use the **raw meter data**, with the **consumer** whose **electricity** is measured or estimated, or whose load is controlled at the **metering installation**.
- (4) A **metering equipment provider** must, within 10 **business days** of receiving a request from 1 of the following parties, give the party access to **raw meter data** from a **metering installation** for which it is responsible:
 - (a) a relevant **reconciliation participant** with whom it has an arrangement, other than a **trader**;
 - (b) the **Authority**;
 - (c) an **ATH**;
 - (d) an **auditor**.
- (5) A party listed in subclause (4) may only request access to **raw meter data** for the purposes of exercising the party's rights and performing the party's obligations under this Code or any relevant regulations in relation to 1 or more of the following:
 - (a) the party's **audit** functions;
 - (b) the party's administration functions;
 - (c) the party's testing functions;
 - (d) the provision of **submission information** to the **reconciliation manager**.
- (6) The **metering equipment provider** must provide a **trader** under subclause (1) or a party under subclause (4) with—
 - (a) the **raw meter data**; or
 - (b) any necessary facilities, codes, keys, or other means to enable the **trader** or party to access the **raw meter data** by the most practicable means.
- (7) The **metering equipment provider** must, when complying with subclause (6), or when providing access to a person under subclause (2), use appropriate procedures to ensure that—
 - (a) the **raw meter data** is received only by—
 - (i) the **trader**, person, or party; or

- (ii) a contractor to a **trader**, person, or party; and
 - (b) the security of the **raw meter data** and the **metering installation** is maintained; and
 - (c) access to **raw meter data** under subclauses (1) to (6) is limited to only the specific **raw meter data**—
 - (i) authorised by a contract described in subclause (3), in the case of a **trader** under subclause (1) or a person under subclause (2); or
 - (ii) required for the purposes of exercising the party's rights and performing the party's obligations under this Code, any relevant regulations, or the **Act** in relation to the party's **audit**, administration, and testing functions, in the case of a party referred to in subclause (4).
- (8) Nothing in this Part affects proprietary interests in **metering data**.
Clause 1(5) and (7)(c)(ii): amended, on 5 October 2017, by clause 183 of the Electricity Industry Participation Code Amendment (Code Review Programme) 2017.
Clause 1(5) and (7)(c)(ii): amended, on 20 December 2021, by clause 29 of the Electricity Industry Participation Code Amendment (Code Review Programme) 2019.

2 Restrictions on use of raw meter data

- (1) A **metering equipment provider** must not give a **trader** under clause 1(1), a person under clause 1(2), or a party under clause 1(3), access to **raw meter data** from a **metering installation** for which it is responsible, if to do so would, or would reasonably be expected to,—
- (a) breach any regulatory or legal requirement; or
 - (b) prejudice the maintenance and monitoring of this Code, including the prevention, investigation, and detection of Code breaches and the right to a fair hearing before the **Authority** or the **Rulings Panel**; or
 - (c) result in the **metering equipment provider** breaching an obligation of confidentiality; or
 - (d) interfere with the privacy of a natural person; or
 - (e) create an improper gain or improper advantage for any **participant** or person; or
 - (f) commercially disadvantage the **metering equipment provider** or any other **participant** or person, in a material manner; or
 - (g) prejudice the future supply of **raw meter data** that is required by a **market operation service provider** to perform an obligation under this Code.
- (2) A **metering equipment provider** must not limit or restrict a person's or party's right to access information from a **metering installation** for which the **metering equipment provider** is responsible, if the right of access is provided for in this Part.

3 Metering equipment provider must provide access to metering installation

- (1) A **metering equipment provider** must, within 10 **business days** of receiving a request from 1 of the following parties, arrange physical access to each **metering component** in a **metering installation** for which it is responsible:
- (a) a relevant **reconciliation participant** with whom it has an arrangement, other than a **trader**;
 - (b) the **Authority**;
 - (c) an **ATH**;

- (d) an **auditor**;
 - (e) a **gaining metering equipment provider**.
- (2) A party listed in subclause (1) may only request physical access to a **metering component** in the **metering installation** for the purposes of exercising the party's rights and performing the party's obligations under this Code or any relevant regulations in relation to 1 or more of the following:
- (a) the party's **audit** functions;
 - (b) the party's administration functions;
 - (c) the party's testing functions;
 - (d) the provision of **metering components**.
- (3) The **metering equipment provider** must arrange for a party under subclause (1) to be provided with any necessary facilities, codes, keys, or other means to enable the party to obtain physical access to all **metering components** in the **metering installation** by the most practicable means.
- (4) In complying with subclause (3), the **metering equipment provider** must use appropriate procedures to ensure that—
- (a) the security of the **metering installation** is maintained; and
 - (b) physical access to the **metering installation** under subclause (1) is limited to only the physical access required for the purposes of exercising the party's rights and performing the party's obligations under this Code or any relevant regulations in relation to the party's **audit**, administration, and testing functions.
- (5) If a party referred to in subclause (1) requires urgent physical access to a **metering installation**, it must advise the relevant **metering equipment provider**, giving all relevant particulars of the physical access required and the reason for the urgency, and the **metering equipment provider** must use its best endeavours to arrange physical access in accordance with the requested urgency.

Clause 3(2) and (4)(b): amended, on 5 October 2017, by clause 184 of the Electricity Industry Participation Code Amendment (Code Review Programme) 2017.

Clause 3(2) and (4)(b): amended, on 20 December 2021, by clause 30 of the Electricity Industry Participation Code Amendment (Code Review Programme) 2019.

4 **Metering equipment provider record keeping and documentation**

- (1) A **metering equipment provider** must—
- (a) for each **metering installation** for which it is responsible, keep accurate and complete records as specified in Table 1 of Schedule 11.4; and
 - (b) for each **metering installation** for which it is responsible other than an **interim certified metering installation**, keep accurate and complete records of—
 - (i) the **certification** expiry date of each **metering component** in the **metering installation**; and
 - (ii) all equipment used in relation to the **metering installation**, including serial numbers and details of the equipment's manufacturer; and
 - (iii) the manufacturer's, or if different the most recent, test certificate for each **metering component** in the **metering installation**; and
 - (iv) the **metering installation** category for the **metering installation**; and
 - (v) all **certification reports** and **calibration reports** showing dates tested, tests carried out, and test results for all **metering components** in the **metering**

- installation; and**
 - (vi) the contractor who installed each **metering component** in the **metering installation; and**
 - (vii) the **certification sticker**, or equivalent details, for each **metering component** that is **certified** under Schedule 10.8 in the **metering installation; and**
 - (viii) seal identification information under clause 47 of Schedule 10.7 relating to the **metering installation; and**
 - (ix) any applicable **compensation factors; and**
 - (x) the owner of each **metering component** within the **metering installation; and**
 - (xi) any applications installed within each **metering component** within the **metering installation; and**
 - (xii) the signed inspection report under clause 44 of Schedule 10.7, confirming that the **metering installation** continues to comply with the requirements of this Part.
- (2) A **metering equipment provider** must, within 10 **business days** of receiving a request from a **participant** for a signed inspection report prepared under clause 44 of Schedule 10.7, make a copy of the report available to the **participant**.
- (3) A **metering equipment provider** must retain **metering records** relating to a **metering component** in a **metering installation** for which it is or was responsible, for at least 48 months after the **metering component** is removed from the **metering installation**, even if—
- (a) the **metering installation** is subsequently **decommissioned; or**
 - (b) the **metering equipment provider** ceases to be responsible for the **metering installation.**
- (4) A **metering equipment provider** must retain **metering records** relating to a **metering installation** for which it is or was responsible, unless—
- (a) the **metering installation** is **decommissioned; or**
 - (b) the **metering equipment provider** ceases to be responsible for the **metering installation; or**
 - (c) the **metering installation** has been **recertified** in accordance with clause 11 of Schedule 10.7 or clause 13 of Schedule 10.7.
- (5) If subclause (4)(a), 4(b) or 4(c) applies, the **metering equipment provider** must retain the **metering records** for at least 48 months after the event described in those subclauses.

Clause 4(3): substituted, on 1 February 2016, by clause 31 of the Electricity Industry Participation Code Amendment (Code Review Programme) 2015.

Clause 4(3): replaced, on 1 March 2024, by clause 40(1) of the Electricity Industry Participation Code Amendment (Code Review Programme) 2024.

Clause 4(4) and (5): inserted, on 1 March 2024, by clause 40(2) of the Electricity Industry Participation Code Amendment (Code Review Programme) 2024.

4A Transfer of metering records

- (1) A **metering equipment provider** that intends to cease being a **metering equipment provider** (MEP A) must transfer its **metering records** to the **metering equipment provider** (MEP B) that is taking responsibility for every **metering component** or **metering installation** that MEP A is responsible for.

- (2) If a **metering equipment provider** (MEP B in subclause (1)) receives **metering records** under subclause (1), it must retain those **metering records** in accordance with clause 4.

Clause 4A: inserted, on 1 March 2024, by clause 41 of the Electricity Industry Participation Code Amendment (Code Review Programme) 2024.

4B Metering equipment provider retention of ATH records

If a **metering equipment provider** receives an **ATH** record under clause 13(2) of Schedule 10.4 or clause 13A(2) of Schedule 10.4, the **metering equipment provider** must retain that record for at least 48 months after the date of expiry of the **certification** of the **metering installation** or **metering component** to which the record relates.

Clause 4B: inserted, on 1 March 2024, by clause 41 of the Electricity Industry Participation Code Amendment (Code Review Programme) 2024.

5 Metering equipment provider to provide access to metering records

- (1) A **gaining metering equipment provider** may request that a **losing metering equipment provider** provide it with access to **metering records** required for the **gaining metering equipment provider** to exercise its rights and perform its obligations under this Code or any relevant regulations in relation to its respective **auditing**, administration, and testing functions.
- (2) The **losing metering equipment provider** must, within 10 **business days** of receiving a request under subclause (1), provide the **gaining metering equipment provider** with—
- the **metering records**; or
 - any necessary facilities, codes, keys, or other means to enable the **gaining metering equipment provider** to obtain access to the **metering records** by the most practicable means.
- (3) In complying with subclause (2), the **losing metering equipment provider** must use appropriate procedures to ensure that—
- the **metering records** are received only by the **gaining metering equipment provider** or its contractor; and
 - the security of the **metering records** is maintained; and
 - it only provides access to the specific **metering records** required for the purposes of the **gaining metering equipment provider** exercising its rights and performing its obligations under this Code or any relevant regulations in relation to its **auditing**, administration, and testing functions.

Clause 5(1) and (3)(c): amended, on 5 October 2017, by clause 185 of the Electricity Industry Participation Code Amendment (Code Review Programme) 2017.

Clause 5(1) and (3)(c): amended, on 20 December 2021, by clause 31 of the Electricity Industry Participation Code Amendment (Code Review Programme) 2019.

6 Provision of metering records when ATH recertifying metering installation

- (1) This clause applies if—
- a **metering equipment provider** contracts with an **ATH** to **recertify a metering installation** for which the **metering equipment provider** is responsible; and
 - the **ATH** did not perform the previous **certification** of the **metering installation**.
- (2) If this clause applies, the **metering equipment provider** must, no later than 10 **business days** after the effective date of the contract, provide the **ATH** with a copy of all relevant **metering records**.

7 Metering equipment provider must use participant identifier

- (1) A **metering equipment provider** must—
 - (a) ensure that it has a unique **participant identifier** for its activities as **metering equipment provider** under this Code; and
 - (b) use its **participant identifier**, if required under this Code, to correctly identify its information.
- (2) A **metering equipment provider** must apply to the **Authority** in the **prescribed form** for a **participant identifier** at least **5 business days** before the **metering equipment provider** requires the **participant identifier**.
- (3) The **Authority** may change a **metering equipment provider's participant identifier**.
- (4) If the **Authority** changes a **metering equipment provider's participant identifier**—
 - (a) it must advise the **metering equipment provider** of the date on which the change takes effect at least 3 months before the date; and
 - (b) the new **participant identifier** becomes effective from the date advised under paragraph (a).

8 Electronic interrogation of metering installation

- (1) This clause applies when **raw meter data** can only be obtained from a **metering equipment provider's back office**.
- (2) A **metering equipment provider** must—
 - (a) ensure that the **interrogation cycle** for each **metering installation** that it electronically **interrogates** does not exceed the maximum **interrogation cycle** in the **registry**; and
 - (b) **interrogate** a **metering installation** for which it is responsible at least once in each maximum **interrogation cycle** in the **registry**; and
 - (c) when electronically **interrogating** a **metering installation**, ensure that the **interrogation** and processing system electronically monitors and corrects its internal clocks against a time source with a verifiable standard, at a frequency sufficient, and no longer than 1 week, to ensure the internal clock is accurate, when carrying out an **interrogation**, to within ± 5 seconds of—
 - (i) **New Zealand standard time**; or
 - (ii) **New Zealand daylight time**.
- (3) A **metering equipment provider** must, for each **metering installation** for which it is responsible, record in the processing system log, the time, the date, and the extent of any change in the internal clock setting in the **metering installation**.
- (4) A **metering equipment provider** must ensure that a **data storage device** in a **metering installation** for which it is responsible for **interrogating** does not exceed the maximum time error set out in Table 1 of subclause (5).
- (5) A **metering equipment provider** must, when **interrogating** a **metering installation**,—
 - (a) compare the time on the internal clock of the **data storage device** with the time on the **interrogation** and processing system clock; and
 - (b) calculate the time error for the **data storage device**; and
 - (c) if the time error calculated under paragraph (b) is equal to or less than the

- applicable time error set out in Table 1, correct the clock of the **data storage device**; and
- (d) if the time error calculated under paragraph (b) is greater than the applicable time error set out in Table 1,—
 - (i) correct the clock of the **data storage device**; and
 - (ii) compare the time of the clock with the time of the **interrogation** and processing system clock; and
 - (iii) advise the affected **reconciliation participant** for the **point of connection**, within **5 business days** of correcting the clock, of any affected **raw meter data**; and
 - (iv) comply with the requirements of clause 10.43; and
 - (e) download the **event log**; and
 - (f) check the **event log** for any evidence of an event that may affect the integrity or operation of the **metering installation** such as malfunctioning or tampering.

Table 1: Maximum permitted time errors

Metering installation category	Half-hour metering installations (seconds)	Non half-hour metering installations (seconds)
1	±30	±60
2	±10	±60
3	±10	NA
4	±10	NA
5	±5	NA

- (5A) A **metering equipment provider** must, if it finds an event that may affect the integrity or operation of a **metering installation**,—
 - (a) investigate and remediate the event; and
 - (b) advise the relevant **reconciliation participant** that it is investigating and remediating the event; and
 - (c) advise the relevant **reconciliation participant** of any corrections to the **raw meter data** required; and
 - (d) advise the relevant **reconciliation participant** of any event that does not affect the integrity or operation of the **metering installation** but which may affect the accuracy of the **raw meter data**.
- (6) The **metering equipment provider** must, when **interrogating** a **metering installation**, ensure that all **raw meter data** downloaded as part of the **interrogation**, and used for submitting information for the purposes of Part 15, is archived—
 - (a) for no less than 48 months after the **interrogation** date; and
 - (b) in a form that cannot be modified without an audit trail being created; and
 - (c) in a form that is secure and prevents access by any unauthorised person; and
 - (d) in a form that is accessible to authorised personnel.
- (7) A **metering equipment provider** must, when **interrogating** a **metering installation**,—

- (a) ensure that for all **metering information**, an **interrogation** log is generated by the **interrogation software** to record details of each **interrogation**; and
- (b) review the **event log** either manually or by an automated **software** function which flags exceptions and—
 - (i) take appropriate action where problems are apparent; and
 - (ii) pass relevant **event log** entries to the **reconciliation participant** for the **metering installation**; and
- (c) ensure that the **interrogation** log forms part of the **interrogation** audit trail and contains the following as a minimum:
 - (i) the date of **interrogation**; and
 - (ii) the time of commencement of **interrogation**; and
 - (iii) the operator of the **interrogation** system identification (where available); and
 - (iv) the unique identifier of the **data storage device** being **interrogated**; and
 - (v) any clock errors outside the range specified in Table 1 of subclause (5) and the extent of any change in the internal clock setting; and
 - (vi) the method of **interrogation**; and
 - (vii) the identifier of the reading device used for **interrogation** (if applicable).
- (8) Subclause (9) applies when—
 - (a) a **metering equipment provider** **interrogates** a **half-hour metering installation** which is a **category 1 metering installation** or a **category 2 metering installation**; and
 - (b) the **certifying ATH** confirmed, as a part of the **metering installation's** most recent **certification**, that the **metering equipment provider's back office** processes include, for each **interrogation** cycle, a comparison of—
 - (i) the increment of the accumulating **meter** registers; and
 - (ii) the sum of the **half-hour metering raw meter data** for the same period.
- (9) When this subclause applies, the **metering equipment provider** must ensure that each electronic **interrogation** of the **metering installation** that retrieves **half hour raw meter data** compares the sum of that data against the increment of the **metering installation's** accumulating **meter** registers for the same period.
- (10) A **metering equipment provider** must not, when **interrogating** a **metering installation**, apply the **compensation factor** recorded in the **registry** for that **metering installation** to any **raw meter data** downloaded as part of the **interrogation**.
- (11) If an electronic **interrogation** of a **metering installation** by a **metering equipment provider** does not download all of the **raw meter data** as part of the **interrogation**, the **metering equipment provider** must—
 - (a) investigate the reasons for the failure, restore communications, and download all of the **raw meter data** as soon as possible but no later than the time specified in subclause (12); or
 - (b) in accordance with clause 3(c) of Schedule 11.4, update the **registry metering records** to show that the **metering component** is no longer an advanced metering infrastructure device.
- (12) If a **metering equipment provider** decides to take the actions specified in subclause (11)(a), the **metering equipment provider** must complete those actions by the earlier

of—

- (a) the number of full days that equate to no more than 25% of the maximum **interrogation** cycle for the **metering installation** from the date of the last successful **interrogation**; and
 - (b) 30 days from the date of the last successful **interrogation**.
- (13) If the **metering equipment provider** does not complete investigating, restoring communications, and downloading all of the **raw meter data** in accordance with subclause (11)(a) within the time specified in subclause (12) or determines at any time during the time period specified in subclause (12) that it will not be able to complete those tasks within that time frame, the **metering equipment provider** must update the **registry metering records** in accordance with clause 3(d) of Schedule 11.4 to show that the **metering component** is no longer an advanced metering infrastructure device.
- Clause 8(3): amended, on 1 February 2021, by clause 23(1) of the Electricity Industry Participation Code Amendment (Metering and Related Registry Processes) 2020.
- Clause 8(5)(f): replaced, on 1 February 2021, by clause 23(2) of the Electricity Industry Participation Code Amendment (Metering and Related Registry Processes) 2020.
- Clause 8(5A): inserted, on 1 February 2021, by clause 23(3) of the Electricity Industry Participation Code Amendment (Metering and Related Registry Processes) 2020.
- Clause 8(6)(b): amended, on 1 November 2018, by clause 30(a) of the Electricity Industry Participation Code Amendment (Code Review Programme) 2018.
- Clause 8(7)(c): amended, on 1 November 2018, by clause 30(b) of the Electricity Industry Participation Code Amendment (Code Review Programme) 2018.
- Clause 8(7)(c)(v): amended, on 1 February 2021, by clause 23(4) of the Electricity Industry Participation Code Amendment (Metering and Related Registry Processes) 2020.
- Clause 8(8)(b): replaced, on 1 February 2021, by clause 23(5) of the Electricity Industry Participation Code Amendment (Metering and Related Registry Processes) 2020.
- Clause 8(9): amended, on 1 February 2021, by clause 23(6) of the Electricity Industry Participation Code Amendment (Metering and Related Registry Processes) 2020.
- Clause 8(10), (11), (12) and (13): inserted, on 1 February 2021, by clause 23(7) of the Electricity Industry Participation Code Amendment (Metering and Related Registry Processes) 2020.

9 Contracting with ATH

A **metering equipment provider** must, when contracting with an **ATH** in relation to the required activities for the **certification** of a **metering installation** for which it is responsible, ensure that an **ATH** contracted to perform work under this Part has the appropriate scope of approval for such work.

Schedule 10.7 cls 10.11, 10.20, 10.26, 10.38 and 10.42

Metering installation requirements

Metering installation general requirements

1 Maintenance and repair of metering installations

- (1) A **metering equipment provider** must comply with subclause (2)—
 - (a) for each **metering installation** for which it is responsible; and
 - (b) for each **metering component** in a **metering installation** for which it is responsible.
- (2) A **metering equipment provider** must ensure that—
 - (a) it carries out regular maintenance, including battery monitoring and replacement, in accordance with the applicable requirements in the **metering records**; and
 - (b) it carries out all necessary repairs; and
 - (c) if it is not possible to repair a **metering installation** or **metering component** so that it complies with the applicable requirements in this Part, it is—
 - (i) replaced with a **metering installation** or **metering component** that complies with the applicable requirements in this Part; or
 - (ii) in the case of a **metering installation**, **decommissioned**; and
 - (d) it documents in the **metering records** all maintenance, repairs, or replacements it carries out at the time it carries out the maintenance, repairs, or replacement.

Metering installation design reports

2 Design reports for metering installations

- (1) A **metering equipment provider** must obtain a design report under this clause for—
 - (a) a proposed new **metering installation** for which it will be responsible, before it installs the **metering installation**; and
 - (b) a modification to an existing **metering installation** for which it is responsible before the modification commences.
- (2) The **metering equipment provider** must ensure that a design report is prepared by a person with an appropriate level of skill, expertise, experience, and qualification.
- (3) The **metering equipment provider** must ensure that a design report includes—
 - (a) a schematic drawing of the **metering installation** for use by an **ATH**; and
 - (b) details of the configuration scheme that programmable **metering components** are to include; and
 - (c) confirmation that the configuration scheme has been approved by an **approved test laboratory**; and
 - (d) for each **services access interface**, the maximum **interrogation** cycle specified in clause 36(4); and
 - (e) any **compensation factor** arrangements; and
 - (f) the method of **certification** required under this Part to be used for the **metering installation**; and

- (g) the name and signature of the person who prepared the design report and the date on which it was signed.
- (4) The **metering equipment provider** must provide the design report to the **certifying ATH** before the **ATH** installs or modifies—
 - (a) the **metering installation**; or
 - (b) a **metering component** in the **metering installation**.

Clause (2)(3)(d): amended, on 1 February 2021, by clause 24 of the Electricity Industry Participation Code Amendment (Metering and Related Registry Processes) 2020.

3 **ATH design report obligations**

- (1) A **certifying ATH** must, before it **certifies** a new or modified **metering installation**, check and approve, in writing, the design report provided under clause 2 (including the configuration scheme and the schematic drawing), to ensure that the proposed new or modified **metering installation**—
 - (a) will function correctly; and
 - (b) will provide the required accuracy and **raw meter data**; and
 - (c) complies with this Part.
- (2) The **certifying ATH** must, within 10 **business days** of the date on which it **certifies** the **metering installation**—
 - (a) update the design report with any changes to the **metering installation** design; and
 - (b) provide a copy of the updated design report to the **metering equipment provider** responsible for the **metering installation**.

4 **Metering equipment provider obligations**

- (1) A **metering equipment provider** must, for each **metering installation** for which it is responsible,—
 - (a) ensure that the sum of the measured error and **uncertainty** does not exceed the maximum permitted error set out in Table 1 of Schedule 10.1 for the category of the **metering installation**; and
 - (b) ensure that the design of the **metering installation**, including its **data storage device** and **interrogation** system, will ensure that the sum of the measured error and the smallest possible increment of the energy value of the **raw meter data** obtained from the **metering installation** does not exceed the maximum permitted error set out in Table 1 of Schedule 10.1 for the category of the **metering installation**; and
 - (c) comply with the requirements applying to the **metering equipment provider** in the design report provided under clause 2; and
 - (d) ensure that the **metering installation** complies with—
 - (i) the design report provided under clause 2; and
 - (ii) this Part.
- (2) A **metering equipment provider** must ensure that, for each **metering installation** for which it is responsible for an **ICP** that is not also an **NSP**,—
 - (a) the **metering installation** configuration does not use subtraction to determine **submission information** used for the purposes of Part 15; and

- (b) which is a category 3 or higher **metering installation**, is a **half-hour metering installation**.
- (3) A **metering equipment provider** must ensure that, for each **metering installation** for which it is responsible for an **NSP** that is not a **point of connection** to the **grid**,—
 - (a) the **metering installation** configuration does not use subtraction to determine **submission information** used for the purposes of Part 15; and
 - (b) it is a **half-hour metering installation**.
- (4) A **metering equipment provider** must, for each **metering installation** for which it is responsible, ensure that it is appropriate having regard to the physical and electrical characteristics of the **point of connection**.

Determination of metering installation categories

5 Determination of metering installation category

An **ATH** must, before it **certifies** a **metering installation**, determine the category of the **metering installation** in accordance with the following:

- (a) subject to clause 6, if the **metering installation** incorporates a current transformer, its category must be determined according to the primary current rating of the current transformer and the connected voltage set out in Table 1 of Schedule 10.1:
- (b) if the **metering installation** does not incorporate a current transformer and the quantity of **electricity** conveyed is measured by a **meter**, it must be category 1.

Clause 5(a): amended, on 23 February 2015, by clause 75 of the Electricity Industry Participation Code Amendment (Distributed Generation) 2014.

Clause 5(a): amended, on 5 October 2017, by clause 186 of the Electricity Industry Participation Code Amendment (Code Review Programme) 2017.

6 Determining metering installation incorporating current transformer to be lower category

- (1) When determining the category of a **metering installation** under clause 5(a), an **ATH** may under subclause (2) determine the category of a **metering installation** to be lower than would otherwise be the case under clause 5(a) only in 1 of the following circumstances:
 - (a) if a protection device, including a fuse or a **circuit breaker**, is installed that limits the maximum current of the **metering installation**:
 - (b) if the **metering equipment provider**, acting reasonably on the basis of historical **metering data**, believes that the maximum current to be conveyed through the **point of connection** will, at all times during the intended **certification** period, be lower than the current setting of the protection device for the category for which the **metering installation**—
 - (i) is **certified**; or
 - (ii) is required to be **certified** by this Code:
 - (c) if the **metering installation** uses less than 0.5 GWh in any 12 month period:
 - (d) if the **metering equipment provider**, acting reasonably on the basis of historical **metering data**, believes that the **metering installation** (including, for example, a **metering installation** for an emergency fire pump or flood pump) will use less

- than 0.5 GWh in any 12 month period.
- (2) An **ATH** may determine the category of a **metering installation** to be lower than would otherwise be the case under clause 5(a) of this Schedule, provided that,—
- (a) if the circumstance in subclause (1)(a) applies, when **certifying the metering installation**, determine the category of the **metering installation** by reference to the maximum current setting of the protection device and, when doing so, the **ATH** must—
 - (i) confirm the suitability and operational condition of the protection device; and
 - (ii) record, in the **metering records**, the rating and setting of the protection device; and
 - (iii) seal the protection device under clause 47; and
 - (iv) apply, if practicable, a warning tag to the seal under clause 47(6):
 - (b) if the circumstance in subclause (1)(b) applies, the **ATH** must, when **certifying the metering installation**, determine the **metering installation** category according to the **metering installation's** expected maximum current but only—
 - (i) at the request of the **metering equipment provider**; and
 - (ii) if the **ATH** considers it appropriate in the circumstances:
 - (c) if the circumstance in subclause (1)(c) or subclause (1)(d) applies and the primary voltage is less than 1 kV, when **certifying the metering installation**, the **ATH** must determine the **metering installation** as category 2:
 - (d) if the circumstance in subclause (1)(c) or subclause (1)(d) applies and the primary voltage is greater than or equal to 1 kV, when **certifying the metering installation**, the **ATH** must determine the **metering installation** as category 3.
- (2A) If when **certifying a metering installation** an **ATH** determines the category of a **metering installation** under—
- (a) subclause (2)(b), then the **metering equipment provider** responsible for the **metering installation** must, each month, obtain a report from the **participant interrogating the metering installation** which details the maximum current conveyed through the **metering installation** for the prior month:
 - (b) subclause (2)(c), then the **metering equipment provider** responsible for the **metering installation** must, each month during the **certification** period, obtain a report from the **participant interrogating the metering installation** which details the total kWh consumption of the **metering installation** for the prior 12 months.
- (2B) For the purposes of subclause (2A)(a), the **metering equipment provider** must determine the maximum current from **raw meter data** from the **metering installation** either:
- (a) by calculation from the kVA by **trading period** if available; or
 - (b) from a maximum current indicator if fitted in the **metering installation**.
- (2C) If a **metering equipment provider** does not receive the report under subclause (2A)(a) in any month, or the report demonstrates that the maximum current conveyed through the **point of connection** at any time during the previous month exceeded the maximum permitted current for the **metering installation** category as **certified, certification** for

- the **metering installation** to which the report relates is automatically cancelled from—
- (a) the date on which the **metering equipment provider** should have received the report; or
 - (b) the date on which the **metering equipment provider** received the report if earlier.
- (2D) If a **metering equipment provider** does not receive the report under subclause (2A)(b) in any month, or the report identifies that the **electricity** conveyed through the **point of connection** exceeded 0.5 GWh during the previous 12 month period, the **certification** for the **metering installation** to which the report relates is automatically cancelled from—
- (a) the date on which the **metering equipment provider** should have received the report; or
 - (b) the date on which the **metering equipment provider** received the report if earlier.
- (3) The **ATH** must, before it determines a **metering installation** to be a lower category under this clause, visit the site of the **metering installation** to ensure that the installation is suitable for the **metering installation** to be determined to be a lower category.
- (4) If an **ATH** determines a **metering installation** to be a lower category under this clause the **metering installation certification report** must include all information required to demonstrate, as at the **certification date**, compliance with this clause.

Clause 6 Heading: amended, on 1 February 2021, by clause 25(1) of the Electricity Industry Participation Code Amendment (Metering and Related Registry Processes) 2020.

Clause 6(1)(b): amended, on 29 August 2013, by clause 30(1) of the Electricity Industry Participation (Metering Arrangements) Code Amendment 2011, Amendment 2013 (No 2).

Clause 6(2)(b)(i): amended, on 29 August 2013, by clause 30(2) of the Electricity Industry Participation (Metering Arrangements) Code Amendment 2011, Amendment 2013 (No 2).

Clause 6(2)(c): amended, on 29 August 2013, by clause 30(3) and (4) of the Electricity Industry Participation (Metering Arrangements) Code Amendment 2011, Amendment 2013 (No 2).

Clause 6(2)(c)(iii): amended, on 29 August 2013, by clause 30(5) of the Electricity Industry Participation (Metering Arrangements) Code Amendment 2011, Amendment 2013 (No 2).

Clause 6(1) and (2): replaced, on 1 February 2021, by clause 25(2) of the Electricity Industry Participation Code Amendment (Metering and Related Registry Processes) 2020.

Clause 6(2A), (2B), (2C) and (2D): inserted, on 1 February 2021, by clause 25(2) of the Electricity Industry Participation Code Amendment (Metering and Related Registry Processes) 2020.

Certification of metering installation

7 Method of certification

- (1) An **ATH** must, when **certifying a metering installation**, only use—
 - (a) the **selected component certification** method under clause 11, if the **metering installation** is a **category 1 metering installation**, a **category 2 metering installation** or a **category 3 metering installation**; or
 - (b) the **fully calibrated certification** method under clause 13.
- (2) Despite subclause (1), an **ATH** may **recertify**—
 - (a) a **category 1 metering installation** using statistical sampling under clause 16; or
 - (b) a **category 2 metering installation** using the approved **comparative recertification** method under clause 12.
- (3) If an **ATH** uses statistical sampling under subclause (2)(a), it must use the applicable

method described in subclause (1)(a) and (1)(b) to **certify** each **metering installation** in the sample.

8 Metering installation certification requirements

- (1) An **ATH** must not **certify** a **metering installation** unless the **metering installation** complies with this Part.
- (2) An **ATH** must, when **certifying** a **metering installation**,—
 - (a) prepare a **certification report** for the **metering installation**; and
 - (b) specify in the **certification report** whether the **metering installation** is —
 - (i) **half hour**; or
 - (ii) **non half hour**; or
 - (iii) **half hour** and **non half hour**; and
 - (c) determine the **services access interfaces** for the **metering installation** under clause 10 of Schedule 10.4 and record in the **metering installation certification report**—
 - (i) each **services access interface**; and
 - (ii) the conditions under which each **services access interface** may be used; and
 - (d) ensure that each **metering component** in the **metering installation** functions correctly.
- (3) An **ATH** may only **certify** a **metering installation** as category 3 or higher if the **metering installation** incorporates a **half hour meter** or **half hour data storage device** to quantify the **electricity** conveyed.
- (4) An **ATH** must, when preparing a **metering installation certification report**, record the category of the **metering installation**.

Clause 8(2)(b)(ii) and (iii): amended, on 1 February 2021, by clause 26(a) and (b) of the Electricity Industry Participation Code Amendment (Metering and Related Registry Processes) 2020.

Clause 8(2)(b)(iii): inserted, on 1 February 2021, by clause 26(c) of the Electricity Industry Participation Code Amendment (Metering and Related Registry Processes) 2020.

Clause 8(2)(c): replaced, on 1 February 2021, by clause 26(d) of the Electricity Industry Participation Code Amendment (Metering and Related Registry Processes) 2020.

Clause 8(3): amended, on 29 August 2013, by clause 31 of the Electricity Industry Participation (Metering Arrangements) Code Amendment 2011, Amendment 2013 (No 2).

8A ATH amends certification reports

- (1) Subject to subclause (2), an **ATH** may amend a **certification report** for a **metering installation** prepared under this Schedule, or a **certification report** for a **metering component** prepared under Schedule 10.8, if—
 - (a) the **ATH** prepared the **certification report**; and
 - (b) the **ATH**—
 - (i) receives, or becomes aware of, new information relevant to the **certification**; or
 - (ii) becomes aware of a change to the **metering installation** or **metering component**, other than a change that affects the accuracy of the **metering installation** or **metering component**; and
 - (c) the new information or change would have caused the **ATH** to reach a different conclusion in its **certification report**.
- (2) An amendment under subclause (1) must not—
 - (a) change the **category** of the **metering installation**:

- (b) extend the **expiry date** in the **certification report**;
- (c) change a **calibration report** in the **certification report**.
- (3) If an **ATH** amends a **certification report** under subclause (1)—
 - (a) the **ATH** must advise the relevant **metering equipment provider** of the changes to the **certification report**; and
 - (b) the **metering equipment provider** must, upon being advised under paragraph (a), update the **registry** in accordance with Part 11.
- (4) Despite anything else in this Part, if an **ATH** amends a **certification report** under this clause, the **certification** of the **metering installation** or **metering component** remains valid to the extent of the amendment.

Clause 8A: inserted, on 12 January 2018, by clause 4 of the Electricity Industry Participation Code Amendment (Amendments to Certification Reports) 2017 and expired on 12 October 2018.

Clause 8A: inserted, on 13 October 2018, by clause 4 of the Electricity Industry Participation Code Amendment (Amendments to Certification Reports) 2018.

9 Certification tests

- (1) An **ATH**, when carrying out a test set out in Table 3 or Table 4 of Schedule 10.1,—
 - (a) to carry out a prevailing load test on a **metering installation** or **metering component**, must do so by using a **working standard** connected to the **metering installation**;
 - (b) to carry out an installation or component configuration test on a **metering installation** or **metering component**, must ensure that the actual configuration scheme is the same as the scheme for the **metering installation** or **metering component** recorded in the design report;
 - (c) to carry out a **raw meter data** output test for a **category 1 metering installation** or **category 2 metering installation**, must do so by—
 - (i) applying a load on each phase that is—
 - (A) greater than 5% of the **meter's** maximum rated current for a **category 1 metering installation**; or
 - (B) 10 amps on each phase for a **category 2 metering installation**; and
 - (ii) using either the **working standard** referred to in subclause (1)(a) or an ammeter in good working order with an accuracy range of +/- 5% to measure the load applied to the **metering installation** and—
 - (A) recording the resulting increment of the **meter** register value over a measured period of time; or
 - (B) recording the resulting accumulation of pulses from the load over a measured period of time; and
 - (iii) ensuring that the change in the **meter** register that occurs under subclause (ii)(A) or subclause (ii)(B) is at least "1" in the least significant digit, or one mark if the least significant digit does not have numerical markings; and
 - (iv) if the **meter** is a Ferraris disc **meter**, undertaking two **raw meter data** output tests in which the second test must have a load applied to the **meter** that is at least double the load applied to the **meter** in the test carried out in accordance with subparagraph (c)(i) and measuring:
 - (A) the increment of the sum of the **meter** registers; or
 - (B) the accumulation of pulses resulting from the increase in load;

- (d) to carry out a **raw meter data** output test for a **half-hour metering installation** which is a **category 1 metering installation** or for a **half-hour metering installation** which is a **category 2 metering installation**, must either—
 - (i) compare the output from a **working standard** to the **raw meter data** from the **metering installation** for a minimum of 1 **trading period**; or
 - (ii) if the **raw meter data** is to be used for the purposes of Part 15, confirm that the **metering equipment provider's back office** processes include a comparison of:
 - (A) the increment of the accumulating **meter** registers; and
 - (B) the sum of the **half-hour metering raw meter data** for the same period:
 - (e) to carry out a **raw meter data** output test for a category 3 or higher **half-hour metering installation**, must compare the output of a **working standard** to the **raw meter data** from the **metering installation** for a minimum of 1 **trading period**:
 - (f) to carry out a **raw meter data** output test for a **non half-hour metering installation** which is a **category 2 metering installation**, must do so by comparing the output of a **working standard** to the increment of the sum of the **meter** registers.
- (1A) If an **ATH** performs a **raw meter data** output test under subclause (1)(c) or subclause (1)(d), for a **metering installation** that will be **certified** for remote **meter** reading, the **ATH** must—
- (a) obtain the **raw meter data** from the **back office** system where the **raw meter data** is held; or
 - (b) ensure that the **metering equipment provider** responsible for the **metering installation** has a process to validate a **meter** reading taken at the time of the **metering installation certification** with a **meter** reading from the **metering equipment provider's back office** system.
- (2) If an **ATH** performs a test under subclause (1) that requires a comparison between 2 quantities, the **ATH** must not **certify** the **metering installation** unless the **metering installation** passes the test.
- (3) For the purposes of subclause (2), a **metering installation** passes if the test demonstrates that the difference between the 2 quantities is within the applicable accuracy tolerances set out in Table 1 of Schedule 10.1.
- Clause 9(1): amended, on 1 February 2021, by clause 27(a) of the Electricity Industry Participation Code Amendment (Metering and Related Registry Processes) 2020.
- Clause 9(1): amended, on 29 August 2013, by clause 32(1) of the Electricity Industry Participation (Metering Arrangements) Code Amendment 2011, Amendment 2013 (No 2).
- Clause 9(1)(c): replaced, on 1 February 2021, by clause 27(b) of the Electricity Industry Participation Code Amendment (Metering and Related Registry Processes) 2020.
- Clause 9(1)(c)(i) and (ii): inserted, on 29 August 2013, by clause 32(2) of the Electricity Industry Participation (Metering Arrangements) Code Amendment 2011, Amendment 2013 (No 2).
- Clause 9(1)(d)(ii): replaced, on 1 February 2021, by clause 27(c) of the Electricity Industry Participation Code Amendment (Metering and Related Registry Processes) 2020.
- Clause 9(1A): inserted, on 29 August 2013, by clause 32(3) of the Electricity Industry Participation (Metering Arrangements) Code Amendment 2011, Amendment 2013 (No 2).

10 Test results

- (1) An **ATH** must, before it **certifies a metering installation** or any of a **metering installation's metering components**, review the relevant test results for each of the **metering installation's metering components** to ensure that—
 - (a) the **metering component** passed all the tests; and
 - (b) the **metering installation** meets the requirements for **certification**.
- (2) If the **ATH** considers that the test results show that the requirements in this Part for **certification** of the **metering installation** are not met, it must—
 - (a) within 5 **business days** of reviewing the tests, advise the relevant **metering equipment provider** providing detailed reasons; and
 - (b) not **certify the metering installation**.

11 Selected component certification of metering installation

- (1) This clause applies only when an **ATH** uses the **selected component certification** method.
- (2) An **ATH** may use the **selected component certification** method to **certify a metering installation** only for the categories of **metering installation** for which the stated requirements are set out in Table 1 of Schedule 10.1.
- (3) An **ATH** must only use the **selected component certification** method to **certify a metering installation**—
 - (a) by carrying out the tests set out in Table 3 of Schedule 10.1; and
 - (b) if an **ATH** or an **approved test laboratory** or an **approved calibration laboratory** has **calibrated** each of the following **metering components** in the **metering installation** in accordance with clause 1(1)(a)(ii) or 1(1)(b) of Schedule 10.8:
 - (i) **meter**;
 - (ii) **measuring transformer**; and
 - (c) if each **data storage device** in the **metering installation** has been **certified** in accordance with clause 5 of Schedule 10.8.
- (4) An **ATH** must, before it uses the **selected component certification** method,—
 - (a) check the design report of the **metering installation** to—
 - (i) confirm the **metering installation** functions in accordance with the design report; and
 - (ii) ensure the **metering installation** complies with this Part; and
 - (b) ensure that each **metering component** in the **metering installation** is used only in a permitted combination as set out in Table 1 of Schedule 10.1; and
 - (c) check and confirm that the **metering installation** is correctly wired in accordance with all applicable requirements and enactments; and
 - (d) ensure that each **metering component** in the **metering installation** is fit for purpose.
- (5) An **ATH** must, when it **certifies a metering installation** under this clause, ensure that the **metering installation certification report** includes confirmation that the **ATH** has—
 - (a) checked the design report of the **metering installation** to—
 - (i) confirm the **metering installation** functions in accordance with the design

- report; and
- (ii) ensure the **metering installation** complies with this Part; and
- (b) ensured that each **metering component** in the **metering installation** has been **calibrated** and **certified** as required in this Part; and
 - (c) ensured that the **metering installation** has passed the relevant tests and checks set out in Table 3 of Schedule 10.1; and
 - (d) checked and confirmed that the **metering installation** is correctly wired in accordance with all applicable requirements and enactments; and
 - (e) carried out any tests and checks required to confirm the integrity of the **metering installation** and recorded these and their results in the **metering installation certification report**.
- (6) An **ATH** must, when it **certifies a metering installation** under this clause, include in the **metering installation certification report**—
- (a) any **compensation factors** that must be applied; and
 - (b) how the **compensation factors** must be applied under clause 2 of Schedule 15.3.

Clause 11(3)(b): substituted, on 29 August 2013, by clause 33(1) of the Electricity Industry Participation (Metering Arrangements) Code Amendment 2011, Amendment 2013 (No 2).

Clause 11(3)(b): amended, on 15 May 2014, by clause 18 of the Electricity Industry Participation (Minor Code Amendments) Code Amendment 2014.

Clause 11(3)(c): inserted, on 29 August 2013, by clause 33(1) of the Electricity Industry Participation (Metering Arrangements) Code Amendment 2011, Amendment 2013 (No 2).

Clause 11(5)(e): amended, on 29 August 2013, by clause 33(2) of the Electricity Industry Participation (Metering Arrangements) Code Amendment 2011, Amendment 2013 (No 2).

12 Comparative recertification

- (1) This clause only applies when an **ATH** uses the **comparative recertification** method.
- (1A) The **comparative recertification** method may only be used to recertify a **category 2 metering installation**.
- (2) An **ATH** may only use the **comparative recertification** method to **recertify a category 2 metering installation** in accordance with this Part if—
- (a) the **certification** of the current transformers in the **metering installation** expires before the **meter certification** expiry date; and
 - (b) each of the following **metering components** in the **metering installation** is **certified** at the date of **recertification** in accordance with Schedule 10.8:
 - (i) **data storage device**;
 - (ii) **meter**.
- (2A) For the avoidance of doubt, an **ATH** may use the **comparative recertification** method to **recertify a category 2 metering installation** in accordance with this Part if the **certification** of the current transformers in the **metering installation** has expired.
- (3) An **ATH** must, when **recertifying a category 2 metering installation** under this clause, ensure that—
- (a) the **metering installation** has passed the tests set out in Table 3 of Schedule 10.1, using a **working standard** connected to the **metering installation**; and
 - (b) the current measurement sensor connected around the cables or bus-bars adjacent to the **metering installation** is sufficiently accurate so that the sum of the measured **metering installation** accuracy, the **uncertainty** of the **metering**

- installation**, and the **uncertainty** of the current measurement sensor does not exceed the maximum permitted error set out in Table 1 of Schedule 10.1 for the category of the **metering installation**; and
- (c) the overall **metering installation** accuracy meets the requirements of Table 1 of Schedule 10.1.
- (4) An **ATH** must, before it uses the **comparative recertification** method—
- (a) check the design report of the **metering installation** to—
- (i) confirm the **metering installation** functions in accordance with the design report; and
- (ii) ensure the **metering installation** complies with this Part; and
- (b) check and confirm that the **metering installation** is correctly wired in accordance with all applicable requirements and enactments; and
- (c) carry out any tests and checks required to confirm the integrity of the **metering installation** and record these and their results in the **metering installation certification report**.
- (5) An **ATH** must, for each **metering installation** it **certifies** under this clause,—
- (a) prepare a **certification report**; and
- (b) ensure that each **metering component** in the **metering installation** is fit for purpose.

Clause 12(1A): inserted, on 1 February 2021, by clause 28(a) of the Electricity Industry Participation Code Amendment (Metering and Related Registry Processes) 2020.

Clause 12(2)(b): amended, on 1 February 2021, by clause 28(b) of the Electricity Industry Participation Code Amendment (Metering and Related Registry Processes) 2020.

Clause 12(2A): inserted, on 1 February 2021, by clause 28(c) of the Electricity Industry Participation Code Amendment (Metering and Related Registry Processes) 2020.

13 Fully calibrated metering installation certification

- (1) This clause only applies when an **ATH** uses the **fully calibrated certification** method.
- (2) An **ATH** may only use the **fully calibrated certification** method to **certify** a **category 1 metering installation**, or higher category of **metering installation**.
- (3) An **ATH** must use the **fully calibrated certification** method to **certify** a **metering installation**—
- (a) by carrying out the tests set out in Table 4 of Schedule 10.1; and
- (b) only if each of the following **metering components** in the **metering installation** has been **certified** in accordance with Schedule 10.8:
- (i) **data storage device**;
- (ii) **meter**;
- (iii) **measuring transformer**.
- (4) An **ATH** must ensure that each **metering component** in a **metering installation** which is **certified** under this clause has a current **certification report** that—
- (a) complies with the requirements of this Part; and
- (b) if the **metering component** is a **calibrated metering component**, includes a **calibration report** that—
- (i) confirms that the **metering component** complies with the requirements of its accuracy class set out in Table 1 of Schedule 10.1; and
- (ii) includes the **certification** date of the **metering component**.

- (5) An **ATH** must, when preparing a **metering installation certification report** under this clause, include confirmation that the **ATH** has—
- (a) checked the design report of the **metering installation** to—
 - (i) confirm the **metering installation** functions in accordance with the design report; and
 - (ii) ensure the **metering installation** complies with this Part; and
 - (b) ensured that each **metering component** in the **metering installation** has been **calibrated** and **certified** as required in this Part; and
 - (c) ensured that the relevant tests and checks set out in Table 4 of Schedule 10.1 have been passed; and
 - (d) checked and confirmed that the **metering installation** is correctly wired in accordance with all applicable requirements and enactments; and
 - (e) carried out any tests and checks required to confirm the integrity of the **metering installation**.
- (6) An **ATH** must, when it **certifies** a **metering installation** under this clause, include in the **metering installation certification report**—
- (a) any **compensation factors** that must be applied; and
 - (b) how the **compensation factors** must be applied under clause 2 of Schedule 15.3.
- (7) An **ATH** must, before it **certifies** a **metering installation** under this clause, ensure that the **ATH** uses the manufacturer's **meter** class accuracy, and not the **meter's** actual tested accuracy, to determine whether the **metering installation** is within the relevant maximum permitted error set out in Table 1 of Schedule 10.1.

14 Insufficient load for metering installation certification tests

- (1) This clause only applies if there is insufficient **electricity** conveyed through a **point of connection** to allow an **ATH** to complete a prevailing load test for a **metering installation** that is being **certified** as a **half-hour metering installation**.
- (2) When this clause applies, the **ATH** must, when **certifying** the **metering installation**, ensure that—
- (a) it performs an additional integrity check of the **metering installation** wiring, and records the results of this check in the **certification report**; and
 - (b) it records in the **certification report** that the **metering installation** is **certified** under this clause.
- (3) A **metering equipment provider** must, for each **metering installation** for which it is responsible, and that is **certified** under this clause, obtain and monitor **raw meter data** from the **metering installation** at least once each month during the period of **certification** to determine if load during the month is sufficient for a prevailing load test to be completed.
- (4) Despite subclause (1), the **metering equipment provider** must, if **raw meter data** obtained under subclause (3) demonstrates, at any time, that there is sufficient **electricity** conveyed through the **point of connection** for a prevailing load test to be completed, ensure that the **certifying ATH** makes a subsequent visit to the **metering installation** as soon as practicable, but no later than 20 **business days** after the **metering equipment provider** has obtained the **raw meter data**, to carry out and

complete the tests set out in Table 4 of Schedule 10.1.

- (5) The **certifying ATH** must, if the tests referred to in subclause (4) demonstrate that the **metering installation** performs within the relevant maximum permitted error set out in Table 1 of Schedule 10.1,—
- (a) update the **metering installation certification report**, within 5 **business days** of completing the tests, to include the results of the tests carried out; and
 - (b) leave the original **metering installation certification** expiry date unchanged.
- (6) If the tests referred to in subclause (4) demonstrate that the **metering installation** does not perform within the relevant maximum permitted error set out in Table 1 of Schedule 10.1—
- (a) the **metering installation certification** is automatically cancelled from the date of the tests; and
 - (b) the **certifying ATH** must advise the **metering equipment provider** of the cancellation within 1 **business day** of carrying out the tests; and
 - (c) the **metering equipment provider** must follow the procedure set out in clauses 10.43 to 10.48.

Clause 14(1): amended, on 29 August 2013, by clause 34 of the Electricity Industry Participation (Metering Arrangements) Code Amendment 2011, Amendment 2013 (No 2).

Clause 14(3): amended, on 5 October 2017, by clause 187 of the Electricity Industry Participation Code Amendment (Code Review Programme) 2017.

15 Recertification programme

- (1) A **metering equipment provider** must have a **recertification** programme for all **metering installations** for which it is responsible to ensure that each **metering installation** is **recertified** prior to the expiry date of its then current **certification** if the **metering installation** is not **decommissioned**.
- (2) Subclause (1) does not apply to an **electrically disconnected metering installation** for an **ICP**.

Clause 15(2): amended, on 5 October 2017, by clause 188 of the Electricity Industry Participation Code Amendment (Code Review Programme) 2017.

Statistical sampling recertification

16 Recertification of group of category 1 metering installations by statistical sampling

- (1) A **metering equipment provider** may arrange for an **ATH** to **recertify** a group of **category 1 metering installations** for which the **metering equipment provider** is responsible using a statistical sampling process set out in subclause (2).
- (2) To **recertify** a group of **category 1 metering installations**, an **ATH** must—
- (a) select a sample from the group, using a statistical sampling process—
 - (i) prescribed in AS/NZS 1284.13:2002; or
 - (ii) that is approved and **published** by the **Authority**; and
 - (aa) use the pass/fail criteria in AS/NZS 1284.13:2002 to evaluate whether the group meets the **recertification** requirements of this Part; and
 - (ab) if the group meets the **recertification** requirements of this Part use the appropriate maximum validity period set out in Table 5 of AS/NZS 1284.13:2002 as the **certification** validity period for each **metering installation** in the group, except

- that if a class 1 static (electronic) **meter** sample is within the accuracy tolerance of $\pm 1.5\%$, the appropriate maximum validity period for that group is 7 years; and
- (b) **recertify** each **metering component** in the **metering installation** in the sample using—
 - (i) the **fully calibrated certification** method; or
 - (ii) the **selected component certification** method; and
 - (c) advise the **metering equipment provider** as soon as reasonably practicable, if the group—
 - (i) meets the **recertification** requirements of this Part; or
 - (ii) fails to meet the **recertification** requirements of this Part.
- (3) An **ATH** must, when selecting a sample from the group under subclause (2)(a),—
- (a) document the process it follows and any assumptions it makes; and
 - (b) keep records in accordance with clause 13 of Schedule 10.4, of—
 - (i) each step in the process; and
 - (ii) each **metering installation** in the sample; and
 - (iii) each **metering installation** in the group that is **recertified** using this process.
- (4) The **recertification** of a **metering installation** in the group—
- (a) commences from the date of the advice referred to in subclause (2)(c)(i) if the sample meets the **recertification** requirements of this Part;
 - (b) is automatically cancelled from the date of the advice referred to in subclause (2)(c)(ii) if the sample fails to meet the **recertification** requirements of this Part.
- (5) The **metering equipment provider** must, upon being advised under subclause (2)(c), update the **registry** in accordance with Part 11.
- (6) Despite clause 41(1), an **ATH** who **recertifies** a group of **metering installations** using a statistical sampling process is not required to apply a **certification sticker** to a **metering installation** in the group that was not part of the sample.

Clause 16(2)(a)(i): amended, on 29 August 2013, by clause 35(1) of the Electricity Industry Participation (Metering Arrangements) Code Amendment 2011, Amendment 2013 (No 2).

Clause 16(2)(aa): inserted, on 29 August 2013, by clause 35(3) of the Electricity Industry Participation (Metering Arrangements) Code Amendment 2011, Amendment 2013 (No 2).

Clause 16(2)(ab): inserted, on 1 February 2021, by clause 29 of the Electricity Industry Participation Code Amendment (Metering and Related Registry Processes) 2020.

Clause 16(2)(b): substituted, on 29 August 2013, by clause 35(4) of the Electricity Industry Participation (Metering Arrangements) Code Amendment 2011, Amendment 2013 (No 2).

Clause 16(2)(c): amended, on 29 August 2013, by clause 35(5) of the Electricity Industry Participation (Metering Arrangements) Code Amendment 2011, Amendment 2013 (No 2).

Clause 16(2)(a)(i), (aa) and (ab): amended, on 1 March 2024, by clause 42(1) and (2) of the Electricity Industry Participation Code Amendment (Code Review Programme) 2024.

Certification validity periods

17 Determination of expiry dates for certification of metering components and metering installations

- (1) An **ATH** must, when **certifying a metering installation**,—
- (a) determine, in accordance with this clause, the date on which the **metering installation's certification** will expire; and
 - (b) record the expiry date in the **metering installation certification report**.

- (2) The expiry date for a **metering installation's certification** is the earliest of—
- (a) the date falling after the date of its **commissioning** by the number of months equivalent to the maximum **metering installation certification** validity period for the relevant category of **metering installation**, as set out in Table 1 of Schedule 10.1; and
 - (b) the earliest **certification** expiry date of a **metering component** in the **metering installation**; and
 - (c) a date determined by the **ATH** taking into account—
 - (i) the condition of each **metering component** in the **metering installation**; and
 - (ii) all relevant circumstances relating to the **metering installation**.
- (3) Despite subclause (2), the expiry date for each **metering installation** in a group of **metering installations recertified** under clause 16, that does not form a part of the sample, is the earliest expiry date of the **metering installations** in the sample.

18 Interim certified metering installations

A **metering equipment provider** must ensure that each **interim certified metering installation** on 28 August 2013 is **certified** under this Part by no later than 1 April 2015.

Clause 18: amended, on 29 August 2013, by clause 36 of the Electricity Industry Participation (Metering Arrangements) Code Amendment 2011, Amendment 2013 (No 2).

19 Modification of metering installations

- (1) If a **metering installation** is modified, the **certification** of the **metering installation** is automatically cancelled with effect from—
- (a) the date the modification began; or
 - (b) if the **metering equipment provider** responsible for the **metering installation** does not know the date in subclause (a), the date on which the **metering equipment provider** became aware of, or would reasonably have been expected to have become aware of, the modification.
- (2) For the purposes of this Part, a modification of a **metering installation** includes, any 1 or more of the following:
- (a) any change to the **software**, ROM, or firmware in the **metering installation** that may affect the operation of the **metrology layer** unless the change is made under subclause (3):
 - (b) replacement, installation, removal, repair, or modification, of a **metering component** in the **metering installation**, other than the temporary connection of testing or monitoring equipment by using a **test facility**:
 - (ba) replacing a **metering installation** with a new **metering installation**:
 - (c) any change to the burdening of a **measuring transformer** in the **metering installation**, unless changed under clause 31(6):
 - (d) reconfiguration of any wiring (but not straight replacement of wiring in a **category 1 metering installation**):
 - (e) relocation of a **metering component** in the **metering installation** or the **metering installation** enclosure:

- (f) any interference with the **metering installation** that affects the accuracy of the **metering installation**.
- (2A) For the purposes of subclause (1), and despite subclause (2), a modification of a **metering installation** does not include the replacement of a modem in the **metering installation** by the **ATH** that is responsible for **certifying the metering installation**.
- (2B) To avoid doubt, replacing a **metering component** or a **metering installation** is a modification of a **metering installation** under subclause (2) including when—
 - (a) the replacement **metering component** or **metering installation** has the same or similar design and functionality as the existing **metering component** or **metering installation**; or
 - (b) the **metering equipment provider** did not need to consult with a **distributor** or **trader** because clause 10.34(2C) applied.
- (3) Despite subclauses (1) and (2)(a), the **certification** of a **metering installation** is not cancelled if—
 - (a) an **approved test laboratory** has tested and confirmed under clause 39 that the integrity of the measurement and logging of a **data storage device** in the **metering installation** would be unaffected by the change; and
 - (b) the change does not, or would not be considered by the **ATH** who most recently **certified the metering installation** to, affect—
 - (i) the accuracy of the **raw meter data** obtained from the **metering installation**; or
 - (ii) the accuracy of the **metrology layer** of the **metering installation**; or
 - (iii) a **compensation factor** programmed into any **metering component** in the **metering installation**; and
 - (c) the **ATH** who most recently **certified the metering installation** approves, in advance, the process of changing the **software**, ROM, or firmware in the **metering installation**; and
 - (d) the change is carried out in accordance with a documented methodology that has been **audited** under this Part; and
 - (e) the **metering equipment provider** responsible for the **metering installation** records in the **metering records** the details of the change, including the time and date; and
 - (f) any change of the **metering installation's** parameters does not affect the **metrology layer**; and
 - (g) *[Revoked]*
 - (h) clause 8A(1) applies.
- (3A) Despite subclauses (1) and (2)(b), the **certification** of a **metering installation** is not cancelled if—
 - (aa) a **control device** that does not switch **meter** registers has malfunctioned and been replaced with a **certified control device**; and
 - (a) the replacement **control device** has the same characteristics as the **control device** it replaces and—
 - (i) is **certified** in accordance with this Part; and

- (ii) will not adversely affect the operation of any other **metering components** or connections to those **metering components**; and
 - (iii) is likely to receive control signals, as required by clause 34; and
 - (iv) is correctly connected and programmed; and
- (b) the **metering equipment provider** responsible for the **metering installation** has in place—
 - (i) an appropriate agreement with the **approved test house** that is responsible for the **certification** of the **metering installation**, to record the replacement in its **metering installation certification** records; and
 - (ii) appropriate procedures for ensuring that replacements are carried out only by persons authorised by the **metering equipment provider**; and
- (c) the **metering equipment provider** updates—
 - (i) the **metering records** with the details of the replacement, including the date; and
 - (ii) the **registry metering records**.
- (3B) In setting a procedure under subclause (3A)(b)(ii), a **metering equipment provider** must ensure that, within 10 **business days** of the replacement occurring, the person carrying out the replacement provides the notice and **metering records** for the replaced **control device** and the replacement **control device** to—
 - (a) the **metering equipment provider**; and
 - (b) the **approved test house** that is responsible for the **certification** of the **metering installation**.
- (3C) Despite subclauses (1) and (2)(b), the **certification** of a **metering installation** is not cancelled, if clause 48(1A) to (1H) applies.
- (4) Despite subclause (2)(e), the **certification** of a **metering installation** continues if—
 - (a) there is a minor repositioning of 1 of the following in a **category 1 metering installation** which does not involve disconnection of wiring:
 - (i) the **meter** in the existing **metering installation** enclosure; or
 - (ii) the existing **metering installation** enclosure; or
 - (b) the relocation does not cause, directly or indirectly, the **metering installation** to be—
 - (i) outside the applicable accuracy tolerances set out in Table 1 of Schedule 10.1; or
 - (ii) defective; or
 - (iii) not fit for purpose.
- (5) *[Revoked]*.
- (6) *[Revoked]*
- (7) *[Revoked]*.

Clause 19(2): amended, on 1 February 2021, by clause 30(a) of the Electricity Industry Participation Code Amendment (Metering and Related Registry Processes) 2020.

Clause 19(2)(b): amended, on 1 February 2021, by clause 30(b) of the Electricity Industry Participation Code Amendment (Metering and Related Registry Processes) 2020.

Clause 19(2)(ba): inserted, on 1 February 2021, by clause 30(c) of the Electricity Industry Participation Code Amendment (Metering and Related Registry Processes) 2020.

Clause 19(2A): inserted, on 29 August 2013, by clause 37(1) of the Electricity Industry Participation (Metering Arrangements) Code Amendment 2011, Amendment 2013 (No 2).

Clause 19(2B): inserted, on 1 February 2021, by clause 30(d) of the Electricity Industry Participation Code

Amendment (Metering and Related Registry Processes) 2020.

Clause 19(3)(f): amended, on 29 August 2013, by clause 37(2) of the Electricity Industry Participation (Metering Arrangements) Code Amendment 2011, Amendment 2013 (No 2).

Clause 19(3)(f): amended, on 1 February 2016, by clause 32(1) of the Electricity Industry Participation Code Amendment (Code Review Programme) 2015.

Clause 19(3)(f): amended, on 13 October 2018, by clause 5(1) of the Electricity Industry Participation Code Amendment (Amendments to Certification Reports) 2018.

Clause 19(3)(g): revoked, on 1 February 2016, by clause 32(2) of the Electricity Industry Participation Code Amendment (Code Review Programme) 2015.

Clause 19(3)(g): inserted, on 29 August 2013, by clause 37(3) of the Electricity Industry Participation (Metering Arrangements) Code Amendment 2011, Amendment 2013 (No 2).

Clause 19(3)(h): inserted, on 13 October 2018, by clause 5(2) of the Electricity Industry Participation Code Amendment (Amendments to Certification Reports) 2018.

Clause 19(3A): amended, on 1 February 2016, by clause 32(3)(a) of the Electricity Industry Participation Code Amendment (Code Review Programme) 2015.

Clause 19(3A)(aa): inserted, on 1 February 2016, by clause 32(3)(b) of the Electricity Industry Participation Code Amendment (Code Review Programme) 2015.

Clause 19(3A) and 19(3B): inserted, on 29 August 2013, by clause 37(3) of the Electricity Industry Participation (Metering Arrangements) Code Amendment 2011, Amendment 2013 (No 2).

Clause 19(3B): amended, on 1 November 2018, by clause 31(a), (b) and (c) of the Electricity Industry Participation Code Amendment (Code Review Programme) 2018.

Clause 19(3C): inserted, on 1 February 2021, by clause 30(e) of the Electricity Industry Participation Code Amendment (Metering and Related Registry Processes) 2020.

Clause 19(5), (6) & (7): revoked, on 20 December 2021, by clause 32 of the Electricity Industry Participation Code Amendment (Code Review Programme) 2019.

20 Cancellation of certification of metering installations

- (1) The **certification of a metering installation** is automatically cancelled on the date on which any 1 of the following events takes place:
- (a) the **metering installation** is modified otherwise than under clause 19(3), 19(3A), or 19(3C);
 - (b) the **metering installation** is classed as outside the applicable accuracy tolerances set out in Table 1 of Schedule 10.1, defective, or not fit for purpose under—
 - (i) this Part; or
 - (ii) any **audit**;
 - (c) an **ATH** advises the **metering equipment provider** responsible for the **metering installation** of—
 - (i) a **reference standard** or **working standard** used to **certify the metering installation** not being compliant with this Part when it was used to **certify the metering installation**; or
 - (ii) the failure of a group of **meters** in the statistical sampling **recertification** process for the **metering installation**; or
 - (iii) the failure of a **certification** test for the **metering installation**;
 - (d) the manufacturer of a **metering component** in the **metering installation** determines that the **metering component** does not comply with the standards to which the **metering component** was tested;
 - (e) an inspection of the **metering installation**, that is required under this Part, is not carried out in accordance with the relevant clauses of this Part;
 - (f) if under clause 6(2) the **metering installation** has been determined to be a lower category, and:
 - (i) the **metering equipment provider** has not received, in any month, the report referred to in clause 6(2A)(a); or

- (ii) the report referred to in clause 6(2A)(a) demonstrates that the maximum current conveyed through the **metering installation**, at any time during the previous month, exceeded the maximum permitted current for the **metering installation** category as **certified**; or
 - (iii) the **metering equipment provider** has not received, in any month, the report referred to in clause 6(2A)(b); or
 - (iv) the report referred to in clause 6(2A)(b) identifies that the **electricity** conveyed through the **point of connection** exceeded 0.5 GWh during the previous 12 month period:
- (g) the **metering installation**—
- (i) is **certified** under clause 14 and sufficient load is available for full **certification** testing; and
 - (ii) has not been retested under clause 14(4):
- (h) a **control device** in the **metering installation certification** is, and remains for a period of at least 10 **business days**, bridged out under clause 35(1):
- (i) the **metering equipment provider** responsible for the **metering installation** is advised by an **ATH** under clause 48(6)(b) that a seal has been removed or broken and the accuracy and continued integrity of the **metering installation** has been affected.
- (j) the **metering installation** is a **half-hour metering installation** and was **certified** after 29 August 2013, the **service access interface** is the **metering equipment provider's back office**, and the **metering equipment provider**—
- (i) fails to comply with clause 8(2)(b) of Schedule 10.6; or
 - (ii) fails to comply with clause 8(9) of Schedule 10.6; or
 - (iii) performs the comparison in clause 8(9) of Schedule 10.6 but—
 - (A) the difference between the sum of the **half hour metering raw meter data** and the increment of the **metering installation's** accumulating **meter** registers is greater than 1kWh; and
 - (B) the **metering equipment provider** has failed to remediate the issue causing the difference and provide the correct data within three **business days**.
- (2) A **metering equipment provider** must, within 10 **business days** of becoming aware that 1 of the events in subclause (1) has occurred in relation to a **metering installation** for which it is responsible—
- (a) update the **metering installation's certification** expiry date in the **registry**; and
 - (b) if any one of the events in subclause (1)(j) has occurred, update the **metering installation's** AMI flag to “N” in the registry.

- (3) The obligations in subclause (2) do not apply if the **metering installation** is **recertified** within the 10 **business days** specified in subclause (2).

Clause 20(1): amended, on 1 February 2016, by clause 33(1) of the Electricity Industry Participation Code Amendment (Code Review Programme) 2015.

Clause 20(1)(a): amended, on 1 February 2016, by clause 33(2) of the Electricity Industry Participation Code Amendment (Code Review Programme) 2015.

Clause 20(1)(a): amended, on 1 February 2021, by clause 31(1)(a) of the Electricity Industry Participation Code Amendment (Metering and Related Registry Processes) 2020.

Clause 20(1)(f): inserted, on 1 February 2021, by clause 31(1)(b) of the Electricity Industry Participation Code Amendment (Metering and Related Registry Processes) 2020.

Clause 20(1)(j): inserted, on 1 February 2021, by clause 31(2) of the Electricity Industry Participation Code Amendment (Metering and Related Registry Processes) 2020.

Clause 20(2): replaced, on 1 February 2021, by clause 31(3) of the Electricity Industry Participation Code Amendment (Metering and Related Registry Processes) 2020.

Clause 20(3): inserted, on 1 February 2021, by clause 31(3) of the Electricity Industry Participation Code Amendment (Metering and Related Registry Processes) 2020.

Accuracy and error calculation

21 Metering installation accuracy

An **ATH** must not **certify a metering installation** if the **metering installation** exceeds the maximum permitted error for the relevant **metering installation** category set out in Table 1 of Schedule 10.1, after the application of any external **compensation factors**.

22 Error Calculation

- (1) An **ATH** must, before it **certifies a metering installation** under clauses 12 or 13, calculate the error of the **metering installation** in accordance with the following:
 - (a) the **ATH** must calculate the percentage error of the **metering installation** using appropriate mathematical methods, taking account of—
 - (i) all sources of measurement error; and
 - (ii) the estimated total quantity of **electricity** to be conveyed through the **metering installation** over the next 12 months; and
 - (b) the error calculation must include **uncertainty** in measurement; and
 - (c) for the purposes of paragraph (b), the **ATH** must calculate **uncertainty** at a 95% level of confidence and in compliance with JCGM 100:2008.
- (2) The **ATH** must not **certify the metering installation** if—
 - (a) the **uncertainty** for the **metering installation** is greater than the relevant maximum site **uncertainty** set out in Table 1 of Schedule 10.1; and
 - (b) the sum of the measured error and the **uncertainty** of the **metering installation** is greater than the relevant maximum permitted error set out in Table 1 of Schedule 10.1.
- (3) The **ATH** must record the calculation under subclause (1)(a) in the **metering installation certification report**.

23 Time keeping requirements

A **metering equipment provider** must, if a time keeping device that is not remotely monitored and corrected controls the switching of a **meter** register in a **metering installation** for which it is responsible, ensure that the time keeping device—

- (a) has a time keeping error of not greater than an average of 2 seconds per day over a period of 12 months; and
- (b) is monitored and corrected at least once every 12 months.

24 Compensation factors

- (1) An **ATH** must, before it **certifies a metering installation** that requires a **compensation factor**—
 - (a) advise the **metering equipment provider** responsible for the **metering**

- installation of the compensation factor; and**
- (b) ensure that the **compensation factor**, whether internally or externally applied, is only applied as follows:
- (i) for **ratio compensation**, on a **category 1 metering installation**, or higher category of **metering installation**; or
 - (ii) for **error compensation**, on a **metering installation** that quantifies **electricity** conveyed through a **point of connection** to the **grid**; or
 - (iii) for **loss compensation**, only on a category 3 or higher **metering installation**.
- (2) An **ATH** must, when it prepares a **certification report** for a **metering installation** that requires a **compensation factor**, record the methodology, assumptions, measurements, calculation, and details of—
- (a) each **compensation factor** that is included within the internal configuration of the **metering installation**; and
 - (b) each **compensation factor** that must be applied to the **raw meter data**.
- (3) A **metering equipment provider** must, for a **metering installation** in relation to which an external **compensation factor** must be applied,—
- (a) if the **metering installation** is for a **point of connection** that is an **NSP**, advise the **reconciliation participant** responsible for the **metering installation** of the **compensation factor** within 10 **business days** of the date on which the **metering installation** is **certified**; or
 - (b) in all other cases, update the **compensation factor** recorded in the **registry** in accordance with Table 1 of Schedule 11.4.

Clause 24(1): amended, on 1 February 2021, by clause 32(a)(i) of the Electricity Industry Participation Code Amendment (Metering and Related Registry Processes) 2020.

Clause 24(1)(b): amended, on 1 February 2021, by clause 31(a)(ii) of the Electricity Industry Participation Code Amendment (Metering and Related Registry Processes) 2020.

Clause 24(3): amended, on 1 February 2021, by clause 31(b)(i) of the Electricity Industry Participation Code Amendment (Metering and Related Registry Processes) 2020.

Clause 24(3)(b): amended, on 1 February 2021, by clause 31(b)(ii) of the Electricity Industry Participation Code Amendment (Metering and Related Registry Processes) 2020.

Clause 24(3)(b): amended, on 5 October 2017, by clause 189 of the Electricity Industry Participation Code Amendment (Code Review Programme) 2017.

Installation of metering components in metering installations

25 Installation of metering components

- (1) An **ATH** must, before it **certifies** a **metering installation**, ensure that installation of—
- (a) **measuring transformers**, and associated burden if required, **test facilities**, potential fuses, and switchboard wiring, was carried out by—
 - (i) a suitably qualified person (for example by a switchboard manufacturer); or
 - (ii) an **ATH**; and
 - (b) each **metering component** in the **metering installation**, other than a **metering component** referred to in paragraph (a), is carried out by an **ATH**.
- (2) An **ATH** must, before it **certifies** a **metering installation**, ensure that each **metering component** in the **metering installation** has been installed in accordance with the design report under clause 2.

26 Requirements for metering installation incorporating meter

- (1) A **metering equipment provider** must ensure that each **meter** in a **metering installation** for which it is responsible is **certified** in accordance with this Part.
- (2) An **ATH** must, unless clause 43(2) applies, before it **certifies a metering installation** incorporating a **meter**, if the **meter** had previously been used in another **metering installation**, ensure that the **meter** has been **recalibrated** since it was removed from the previous **metering installation**, by—
 - (a) an **approved calibration laboratory**; or
 - (b) an **ATH**.
- (3) The **ATH** must, before it **certifies a metering installation** incorporating a **meter**, document in the **metering records**—
 - (a) any regular maintenance required for the **meter** in accordance with the manufacturer's recommendations; and
 - (b) any maintenance that has been carried out on the **meter** (for example battery monitoring and replacement).
- (4) An **ATH** must, before it **certifies a metering installation** incorporating a **meter**, record in the **metering installation certification report**, the maximum **interrogation** cycle for the **metering installation**.
- (5) The maximum **interrogation** cycle for a **metering installation** referred to in subclause (4) is the period of memory availability given the **meter** configuration.
- (6) Subclause (4) does not apply to a **metering installation** incorporating both a **meter** and a **data storage device** (see clause 36 of Schedule 10.7).

Clause 26(2): amended, on 1 February 2016, by clause 34(1) of the Electricity Industry Participation Code Amendment (Code Review Programme) 2015.

Clause 26(6): substituted, on 1 February 2016, by clause 34(2) of the Electricity Industry Participation Code Amendment (Code Review Programme) 2015.

27 Meter certification expiry date

- (1) An **ATH** must, before it **certifies a metering installation** incorporating a **meter**, determine the **meter certification** expiry date for each **meter** in the **metering installation** in accordance with this clause.
- (2) The **meter certification** expiry date must be the earliest end date of the following periods, calculated from the date of **commissioning** of the **metering installation**:
 - (a) the maximum **metering installation certification** validity period set out in Table 1 of Schedule 10.1 for the relevant category of **metering installation**; or
 - (b) [*Revoked*]
 - (c) the **certification** period specified in the **meter certification report**.
- (3) Despite subclause (2), the **meter certification** expiry date for a **meter** that has been **certified** and subsequently installed in, but then removed from, a **category 1 metering installation**, remains the **meter certification** expiry date determined for that **meter** when it was installed in the **category 1 metering installation**.
- (4) Despite subclauses (2) and (3), if **meter** is not installed in a **metering installation** within 24 months of the date of the **meter's certification report**, the **meter** must be **recertified** before it is installed.
- (5) The **ATH** must record the **certification** expiry date for each **meter** in a **metering installation** in—

- (a) the **metering installation certification report**; and
- (b) the **meter certification report**.

Clause 27(2)(b): revoked, on 1 February 2021, by clause 33(a) of the Electricity Industry Participation Code Amendment (Metering and Related Registry Processes) 2020.

Clause 27(3): amended, on 29 August 2013, by clause 38 of the Electricity Industry Participation (Metering Arrangements) Code Amendment 2011, Amendment 2013 (No 2).

Clause 27(4): amended, on 1 February 2021, by clause 33(b) of the Electricity Industry Participation Code Amendment (Metering and Related Registry Processes) 2020.

28 Requirements for metering installation incorporating measuring transformer

- (1) A **metering equipment provider** must ensure that each **measuring transformer** in a **metering installation** for which it is responsible is **certified** in accordance with this Part.
- (2) An **ATH** must, before it **certifies** a **metering installation** which includes a **measuring transformer** that had previously been used in another **metering installation**, ensure that the **measuring transformer** has been **recalibrated**, since it was removed from the previous **metering installation**, by—
 - (a) an **approved calibration laboratory**; or
 - (b) an **ATH**.
- (3) The **ATH** must, before it **certifies** a **metering installation** incorporating a **measuring transformer**, document in the **metering records**—
 - (a) any regular maintenance required for the **measuring transformer** in accordance with the manufacturer's recommendations; and
 - (b) any maintenance that has been carried out on the **measuring transformer**.
- (4) An **ATH** must, before it **certifies** a **metering installation** incorporating a **measuring transformer**,—
 - (a) ensure that—
 - (i) the **measuring transformer** is connected to a **meter** through a **test facility** that has provision for isolation; and
 - (ia) the **test facility** and the provision for isolation are installed as physically close to the **meter** as practicable in the circumstances; and
 - (ii) the **test facility** has a transparent cover that is not obscured; and
 - (b) using the **fully calibrated certification** method or the **comparative recertification** method, ensure that the **ATH** calculates the maximum permitted error in accordance with clause 22; and
 - (c) carry out primary injection tests on the **measuring transformer** if it considers it is appropriate in the circumstances; and
 - (d) ensure that the **measuring transformer** is—
 - (i) mounted securely; and
 - (ii) if practicable, in an enclosure that is sealed in accordance with clause 47 against unauthorised access; and
 - (e) ensure that any voltage supply from a voltage transformer to a **meter**, or other equipment in the **metering installation**, is protected by appropriately rated fuses or **circuit breakers** dedicated to the supply; and
 - (f) ensure that all fuses and **circuit breakers** are sealed or located in sealed enclosures under clause 47; and

- (g) ensure that, if an enclosure also contains fuses or **circuit breakers** supplying other circuits, those supplying **metering** circuits are individually sealed; and
 - (h) ensure that if the **measuring transformer's** secondary circuit in the **metering installation** is earthed, it is earthed at no more than 1 point; and
 - (i) ensure that the total in-service burden (magnitude and phase angle, where appropriate) on the **measuring transformer** complies with clause 31.
 - (i) *[Revoked]*
 - (ii) *[Revoked]*.
- (5) Despite subclause (4)(d)(ii), if access to the enclosure is required by a person other than an employee or subcontractor of an **ATH**, the **ATH** may use alternative sealing arrangements (for example, terminal studs drilled so that sealing wire can be passed through the holes to secure the connections, or the use of sealing paint applied to terminal screws).

Clause 28(4)(a): substituted, on 29 August 2013, by clause 39 of the Electricity Industry Participation (Metering Arrangements) Code Amendment 2011, Amendment 2013 (No 2).

Clause 28(4)(b): replaced, on 1 February 2021, by clause 34(a) of the Electricity Industry Participation Code Amendment (Metering and Related Registry Processes) 2020.

Clause 28(4)(i): amended, on 1 February 2021, by clause 34(b)(i) and (ii) of the Electricity Industry Participation Code Amendment (Metering and Related Registry Processes) 2020.

Clause 28(4)(i)(i) and (ii): revoked, on 1 February 2021, by clause 34(b)(iii) of the Electricity Industry Participation Code Amendment (Metering and Related Registry Processes) 2020.

29 Measuring transformer certification expiry date

- (1) An **ATH** must, before it **certifies** a **metering installation** incorporating a **measuring transformer**, determine the **measuring transformer certification** expiry date for each **measuring transformer** in the **metering installation** in accordance with this clause.
- (2) The **measuring transformer certification** expiry date must be no later than the last day of the **measuring transformer certification** validity period specified in the **measuring transformer certification report**, after the date of **commissioning**.
- (3) The **ATH** must record the **measuring transformer certification** expiry date for each **measuring transformer** in a **metering installation** in—
 - (a) the **certification report** for the **metering installation**; and
 - (b) the **certification report** for the **measuring transformer**.

30 Other equipment using measuring transformer

- (1) A **metering equipment provider** must not permit a **measuring transformer**, in a **metering installation** for which it is responsible, to be connected to equipment used at any time for a purpose other than **metering**, unless it is not practical for the equipment to have a separate **measuring transformer**.
- (2) An **ATH** must, before it **certifies** a **metering installation** incorporating a **measuring transformer** used by—
 - (a) another **metering installation**, ensure, where voltage transformers are connected to more than 1 **meter**, that—
 - (i) the **meters** are included in the **metering installation** being **certified**; and
 - (ii) appropriate fuses or **circuit breakers** are provided to protect the **metering** circuit from short circuits or overloads affecting the other **meter**:
 - (b) equipment referred to in subclause (1), ensure that—

- (i) the accuracy of the **metering installation** remains within the maximum permitted error for the relevant **metering installation** category set out in Table 1 of Schedule 10.1; and
- (ii) the **metering installation certification report** confirms that the accuracy of the **metering installation** remains within the maximum permitted error for the relevant **metering installation** set out in Table 1 of Schedule 10.1; and
- (iii) any wiring between the equipment and any part of the **metering installation** has no intermediate joints; and
- (iv) the equipment referred to in subclause (1) is labelled appropriately, including with any restrictions regarding being **electrically disconnected**; and
- (v) the connection details of the equipment referred to in subclause (1) are recorded in the **metering installation** design report; and
- (vi) appropriate fuses or **circuit breakers** are provided to protect the voltage transformer and **metering** circuit from short circuits or overloads affecting the other equipment; and
- (vii) the wiring referred to in subparagraph (iii) is **certified** as part of the **metering installation**.

(3) *[Revoked]*

Clause 30(2)(b)(iv): amended, on 5 October 2017, by clause 190 of the Electricity Industry Participation Code Amendment (Code Review Programme) 2017.

Clause 30(2)(b)(vi): amended, on 29 August 2013, by clause 40(1) of the Electricity Industry Participation (Metering Arrangements) Code Amendment 2011, Amendment 2013 (No 2).

Clause 30(2)(b)(vii): inserted, on 29 August 2013, by clause 40(2) of the Electricity Industry Participation (Metering Arrangements) Code Amendment 2011, Amendment 2013 (No 2).

Clause 30(3): revoked, on 29 August 2013, by clause 40(3) of the Electricity Industry Participation (Metering Arrangements) Code Amendment 2011, Amendment 2013 (No 2).

31 Measuring transformer burden and compensation requirements

- (1) An **ATH** may **certify** a **metering installation** for a **point of connection** to the **grid** that includes **error compensation** factors as an alternative to the use of burden resistors, only if the **ATH** is satisfied the **error compensation** factors will provide a more accurate result than the use of burden resistors.
- (2) A **metering equipment provider** must ensure that a change to, or addition of, a **measuring transformer** burden or **compensation factor** related to a **measuring transformer**, in a **metering installation** for which it is responsible, is only carried out by:
 - (a) the **ATH** who most recently **certified** the **metering installation**; or
 - (b) if the **metering installation** is for a **point of connection** to the **grid**, a suitably qualified person approved by both—
 - (i) the **metering equipment provider** responsible for the **metering installation**; and
 - (ii) the **ATH** who most recently **certified** the **metering installation**.
- (3) An **ATH** must, before it may add or change any burden or **compensation factor** detailed in the design report referred to in clause 2,—
 - (a) obtain the approval of the **metering equipment provider** responsible for the **metering installation**, which may be withheld in the **metering equipment**

- provider's** absolute discretion; and
- (b) if it obtains the approval referred to in paragraph (a), record in the **metering records** the reason for the proposed addition or change.
- (4) A **metering equipment provider** must, before it may approve the addition of, or change to, the burden or **compensation factor** of a **measuring transformer** in a **metering installation** for which it is responsible, consult with the **ATH** who carried out the most recent **certification** of the **metering installation**.
- (5) If the **metering equipment provider** approves the addition of, or change to, the burden or **compensation factor** under subclause (4), it must ensure that the **metering installation**, other than a **metering installation** for a **point of connection** to the **grid**, is **recertified** by an **ATH** for the addition of or change to the burden or **compensation factor** before the addition or change becomes effective.
- (6) Despite subclause (3)(a), an **ATH** may change the burden on a voltage transformer, without obtaining the approval of the **metering equipment provider**, if the **ATH** confirms in the **certification report** that the difference between the new burden and the burden at the time of the most recent **metering installation certification** is—
- (a) less than or equal to one thirtieth of the rating, in VA, of the voltage transformer if the voltage transformer is rated at less than 30 VA; or
- (b) no greater than 1 VA, if the voltage transformer is rated at equal to or greater than 30 VA.
- (7) An **ATH** must, before it **certifies a metering installation** incorporating a **measuring transformer**,—
- (a) ensure that the in-service burden (magnitude and phase angle, where appropriate) on the **measuring transformer** does not exceed the upper limit of the range specified for the **measuring transformer** if specified in the design report for the **metering installation**; and
- (b) ensure that the in-service burden on the **measuring transformer** is within the range specified in the **certification report** for the **measuring transformer** by installing burdening resistors to increase the in-service burden if necessary; or
- (c) confirm that—
- (i) if the primary voltage of the **measuring transformer** is greater than 1kV, a **class A ATH** has confirmed by **calibration** that the accuracy of the **measuring transformer** will not be adversely affected by the in-service burden being less than the lowest burden test point specified in the standard; or
- (ii) the **measuring transformer's** manufacturer has confirmed that the accuracy of the **measuring transformer** will not be adversely affected by the in-service burden being less than the lowest burden test point specified in the standard.

Clause 31(7): replaced, on 1 February 2021, by clause 35 of the Electricity Industry Participation Code Amendment (Metering and Related Registry Processes) 2020.

Clause 31(7): substituted, on 29 August 2013, by clause 41 of the Electricity Industry Participation (Metering Arrangements) Code Amendment 2011, Amendment 2013 (No 2).

Clause 31(7)(b): amended, on 15 May 2014, by clause 19 of the Electricity Industry Participation (Minor Code Amendments) Code Amendment 2014.

Clause 31(7)(b): substituted, on 19 December 2014, by clause 22 of the Electricity Industry Participation Code Amendment (Minor Code Amendments) (No 3) 2014.

32 Alternative certification requirements for metering installation incorporating measuring transformer

- (1) An **ATH** may, if it cannot comply with the requirements of clause 2 of Schedule 10.8 due solely to its inability to obtain physical access to test an installed **measuring transformer** in a **metering installation**, **certify the metering installation** for a period not exceeding 24 months, if—
 - (a) the **measuring transformer** has not previously been **certified** under this clause; and
 - (b) the **ATH** is satisfied, having made due enquiry, that the **metering installation** will comply with the applicable accuracy requirements as set out in Table 1 of Schedule 10.1; and
 - (c) the **ATH** has advised the **metering equipment provider** responsible for the **metering installation** that this clause applies; and
 - (d) in the case of an **ICP** that is not an **NSP**, the **metering equipment provider** has updated the **metering installation's certification** in the **registry**.
- (2) The **metering equipment provider** must, if a **metering installation** for which it is responsible has been **certified** under subclause (1),—
 - (a) by no later than 10 **business days** after the date of **certification** of the **metering installation**, advise the **Authority** in the **prescribed form** of—
 - (i) all relevant details of the **metering installation**; and
 - (ii) the reason or reasons why the **ATH** could not obtain physical access to the **measuring transformer**; and
 - (iii) the reason or reasons why the accuracy of the **metering installation** cannot be outside of the applicable accuracy requirements set out in Table 1 of Schedule 10.1; and
 - (iv) the **metering installation certification** expiry date; and
 - (b) respond, within 5 **business days**, to any requests from the **Authority** for additional information; and
 - (c) ensure that all of the details are recorded in the **metering installation certification report**.
- (3) If an **ATH** **certifies** a **metering installation** under subclause (1), the **metering equipment provider** responsible for the **metering installation** must take all steps to ensure that the **metering installation** is **certified**, before the **metering installation certification** expiry date referred to in subclause (2)(a)(iv), in accordance with all other applicable requirements of this Part.
- (4) If the **Authority** subsequently determines that the **ATH** could have obtained physical access to test an installed **measuring transformer** in the **metering installation**, the **metering installation** is deemed to be defective and the **metering equipment provider** responsible for the **metering installation** must comply with clauses 10.43 to 10.48.

Clause 32(1)(d): amended, on 1 February 2021, by clause 36 of the Electricity Industry Participation Code Amendment (Metering and Related Registry Processes) 2020.

Clause 32(1)(d), (2) and (4): amended, on 5 October 2017, by clause 191 of the Electricity Industry Participation Code Amendment (Code Review Programme) 2017.

33 Requirements for metering installation incorporating control device

- (1A) A **reconciliation participant** that is responsible for a **point of connection** must advise the **metering equipment provider** responsible for the **metering installation** at the **point of connection** if a **control device** in the **metering installation** is to be used by the **reconciliation participant** for any purpose under Part 15 to do either of the following:
- (a) control a load;
 - (b) switch **meter** registers.
- (1) A **reconciliation participant** must ensure that a **control device** is **certified** under this Part by an **ATH** before the **reconciliation participant** uses any **raw meter data** that depends on the operation of the **control device**, for any purpose under Part 15.
- (2) An **ATH** must, before it **certifies** a **metering installation** incorporating a **control device** that must be **certified** under subclause (1),—
- (a) determine the **control device certification** expiry date for each **control device** contained in the **metering installation** as being the same as the **metering installation certification** expiry date; and
 - (b) record the expiry date, for each **control device**, in the **metering installation certification report**; and
 - (c) if the **metering installation** contains a **control device** that had previously been used in another **metering installation**, ensure that the **control device** has been **certified** in accordance with Schedule 10.8 after it was removed from the other **metering installation**; and
 - (d) ensure that the **metering installation certification report** includes confirmation that—
 - (i) the **control device** complies with any applicable standards listed in Table 5 of Schedule 10.1; and
 - (ii) the **control device** is fit for purpose; and
 - (e) check that the **control device** is—
 - (i) likely to receive control signals, as required under clause 34; and
 - (ii) correctly connected; and
 - (iii) correctly programmed.

Clause 33(1A): inserted, on 29 August 2013, by clause 42(1) of the Electricity Industry Participation (Metering Arrangements) Code Amendment 2011, Amendment 2013 (No 2).

Clause 33(1): substituted, on 29 August 2013, by clause 42(2) of the Electricity Industry Participation (Metering Arrangements) Code Amendment 2011, Amendment 2013 (No 2).

34 Control device reliability requirements

- (1) An **ATH** must, before it **certifies** a **metering installation** incorporating a **control device** that is required to be **certified** under clause 33, determine, in consultation with the relevant **distributor** if appropriate, if the likelihood of the **control device** not receiving control signals would affect the accuracy or completeness of the information for the purposes of Part 15.
- (2) A control signal provider, if it is a **participant**, must respond in a timely manner to any

- requests from the **ATH** referred to in subclause (1).
- (3) The **ATH** must, if it determines under subclause (1) that the likelihood of the **control device** not receiving control signals would affect the accuracy or completeness of the information for the purposes of Part 15, advise the **metering equipment provider** responsible for the **metering installation** of its determination, including all relevant details, within 3 **business days** of making its determination.
- (4) If subclause (3) applies—
- (a) the **ATH** may **certify** the **metering installation** excluding the **control device**; and
- (b) the **ATH** must not **certify** the **control device**.
- (5) The **metering equipment provider** must, as soon as reasonably practicable, and at least within 3 **business days** after being advised under subclause (3), advise the following parties of the **ATH's** determination, including all relevant details:
- (a) the **reconciliation participant** for the **point of connection** for the **metering installation**; and
- (b) the control signal provider.

Clause 34(4)(a): substituted, on 29 August 2013, by clause 43 of the Electricity Industry Participation (Metering Arrangements) Code Amendment 2011, Amendment 2013 (No 2).

35 Control device bridged out

- (1) A **participant** must, within 10 **business days** of bridging out a **control device**, or becoming aware of a **control device** being bridged out, advise the following persons:
- (a) the **reconciliation participant** for the **point of connection** for the **metering installation**; and
- (b) the **metering equipment provider** responsible for the **metering installation** incorporating the **control device**.
- (2) A **metering installation** incorporating a **control device** referred to in subclause (1) is defective for the purposes of clause 10.43 if it is used for the purposes of providing information for the purposes of Part 15.

36 Requirements for metering installation incorporating data storage device

- (1) A **metering equipment provider** must ensure that each **data storage device** incorporated in a **metering installation** for which it is responsible, is **certified** in accordance with this Part.
- (2) An **ATH** must, before it **certifies** a **metering installation** incorporating a **data storage device** that had previously been used in another **metering installation**, ensure that the **data storage device** has been **recalibrated** since it was removed from the previous **metering installation**, by—
- (a) an **approved calibration laboratory**; or
- (b) an **approved test laboratory**; or
- (c) an **ATH**.
- (3) An **ATH** must, before it **certifies** a **metering installation** incorporating a **data storage device** (including a **metering installation** incorporating both a **meter** and a **data storage device**), record in the **metering installation certification report**, the maximum **interrogation** cycle for the **data storage device**.

- (4) The maximum **interrogation** cycle for each **services access interface** for a **metering installation** incorporating a **data storage device** is the shortest of the following periods:
- (a) the period of inherent data loss protection for the **metering installation**; and
 - (b) the period of memory availability given the **data storage device** configuration; and
 - (c) the longest period in which the accumulated drift of a **data storage device** clock is expected to remain in compliance with the maximum time error set out in Table 1 of clause 2 of Schedule 15.2 for the category of the **metering installation**.

Clause 36(3): amended, on 29 August 2013, by clause 44 of the Electricity Industry Participation (Metering Arrangements) Code Amendment 2011, Amendment 2013 (No 2).

Clause 36(3): amended, on 1 February 2016, by clause 35 of the Electricity Industry Participation Code Amendment (Code Review Programme) 2015.

Clause 36(4): amended, on 1 February 2021, by clause 37 of the Electricity Industry Participation Code Amendment (Metering and Related Registry Processes) 2020.

37 Data storage device certification expiry date

- (1) An **ATH** must, before it **certifies a metering installation** incorporating a **data storage device**—
- (a) determine, in accordance with this clause, the **data storage device certification expiry date** for each **data storage device** contained in the **metering installation**; and
 - (b) record the expiry date in the **metering installation certification report**.
- (2) The **data storage device certification expiry date** must—
- (a) for a **data storage device** that is integral to a **meter**, be no later than the **meter certification expiry date**; or
 - (b) for a **data storage device** that is not integral to a **meter**, be no later than the earlier of—
 - (i) the date falling the number of days equivalent to the **data storage device certification validity period** specified in the **data storage device certification report**, after the **commissioning date**; and
 - (ii) the **meter certification expiry date**.
- (3) The **ATH** must record the **data storage device certification expiry date** for a **data storage device** in a **metering installation** in—
- (a) the **certification report** for the **metering installation**; and
 - (b) the **certification report** for the **data storage device**.

38 Requirements for certification of metering installation incorporating data storage device

- (1) An **ATH** must, before it **certifies a metering installation**, ensure that each **data storage device** in the **metering installation**—
- (a) is installed so that onsite **interrogation** is possible without the need to interfere with seals; and
 - (b) has a dedicated power supply unless the **data storage device** is integrated with another **metering component**.
- (2) An **ATH** must, before it **certifies a metering installation**,—

- (a) ensure that each **data storage device** in the **metering installation**—
 - (i) is compatible with each other **metering component** of the **metering installation**; and
 - (ii) is suitable for the electrical and environmental site conditions in which it is installed; and
 - (iii) has been **certified** under Schedule 10.8; and
 - (iv) has appropriate electrical separation between all of its outputs and inputs, and all of its outputs and inputs are rated for purpose; and (v) has no outputs that will interfere with the operation of the **metering installation**; and
 - (vi) records periods of data identifiable or deducible by both date and time on **interrogation**; and
 - (b) check and confirm in the **metering installation certification report** that each **data storage device** in the **metering installation**—
 - (i) has memory capacity and functionality that is suitable for the proposed functions of the **data storage device** specified in the design report for the **metering installation**; and
 - (ii) has availability of memory for a period that is suitable for the proposed functions as set out in the design report for the **metering installation**, and for a minimum continuous period of 15 days.
- (3) An **ATH** must, before it **certifies** a **metering installation** incorporating a **data storage device**, document in the **metering records**—
- (a) any regular maintenance required for the **data storage device** in accordance with the manufacturer's recommendations; and
 - (b) any maintenance that has been carried out on the **data storage device** (for example battery monitoring and replacement).

Heading: amended, on 1 February 2016, by clause 36 of the Electricity Industry Participation Code Amendment (Code Review Programme) 2015.

Clause 38(2)(a)(iv): replaced, on 5 October 2017, by clause 192 of the Electricity Industry Participation Code Amendment (Code Review Programme) 2017.

39 Changes to data storage device software, ROM, or firmware

- (1) A **metering equipment provider** must, if it proposes to change the **software**, ROM, or firmware of a **data storage device** installed in a **metering installation** for which it is responsible, ensure that, before the change is carried out, an **approved test laboratory**—
 - (a) tests and confirms that the integrity of the measurement and logging of the **data storage device** would be unaffected by the proposed change; and
 - (b) documents the methodology and conditions necessary to implement the proposed change; and
 - (c) advises the **ATH** that **certified** the **metering installation** of any change that would, or would be likely to, affect the accuracy of the **data storage device**.
- (2) A **metering equipment provider** must, when implementing a proposed change described in subclause (1),—
 - (a) carry out the change in accordance with the documented methodology and conditions referred to in subclause (1)(b); and

- (b) keep a list of **data storage devices** to which the change was made; and
- (c) update the **metering records** for each **metering installation** referred to in subclause (1) with details of the change and the methodology referred to in subclause (1)(b).

40 **Communication equipment requirements**

A **metering equipment provider** must ensure that the use of its **communication equipment** complies with the compatibility and connection requirements of any communication network operator to whose communication network the **metering equipment provider** has **communication equipment** connected.

41 **Certification stickers**

- (1) An **ATH** must, except as provided for in clause 16(6) and subclause (4), if it has **certified** a **metering installation** under this Part, confirm the **certification** by attaching a **metering installation certification sticker** as physically close as practicable to (including, if practicable, on) the **meter** while maintaining reasonable visibility of the **certification sticker** and the **meter**.
- (2) An **ATH** attaching a **metering installation certification sticker** must ensure that it shows—
 - (a) the name of the **ATH** who **certified** the **metering installation**; and
 - (b) the most recent **certification date** of the **metering installation**; and
 - (c) the **metering installation** category for which the **metering installation** has been **certified**; and
 - (d) the **ICP identifier** for the **metering installation**; and
 - (e) the **certification** number for the **metering installation**; and
 - (f) any other information that the **Authority** may, from time to time, specify by giving reasonable notice.
- (3) An **ATH** must, when **certifying** a **metering installation** that includes a **metering component** that does not have a **certification sticker** attached—
 - (a) obtain the **metering component certification sticker** required under clause 8 of Schedule 10.8; and
 - (b) attach it next to the **metering installation certification sticker**.
- (4) Despite subclauses (1) and (3)(b), the **ATH** must, if attaching a **metering installation certification sticker** as required under subclause (1) is not practicable,—
 - (a) devise and use an alternative means of documenting, providing, and maintaining information in a manner at least equivalent in its effect to that required under subclause (1); and
 - (b) keep any **metering component certification sticker** with the information referred to in paragraph (a).
- (5) If an **ATH** **certifies** a **metering component** of a **metering installation** on the same day that the **ATH** **certifies** the **metering installation**, the **ATH** may combine the **metering installation certification sticker** under subclause (1) with the **metering component certification sticker** under clause 8(1) of Schedule 10.8.
- (6) If an **ATH** combines a **metering installation certification sticker** with the **metering component certification sticker** under subclause (5), the **ATH** must—

- (a) ensure that the combined sticker shows all the information required by subclause (2) and clause 8(2) of Schedule 10.8; and
 - (b) meet the requirements of subclauses (1), (3) and (4), as if the combined sticker were a **metering installation certification sticker**.
- (7) The combined sticker under subclause (5) is immediately invalid if—
- (a) the **metering installation** certification expiry date changes; or
 - (b) a **metering component** to which the combined **certification sticker** relates is removed from the **metering installation**.
- (8) For the avoidance of doubt, the **certification** of any **metering component** that is not removed from the **metering installation** does not become invalid under subclause (7).
- (9) An **ATH** must, when attaching a **metering installation certification sticker** under subclause (1), remove or obscure any invalid or expired **certification stickers**.
- Clause 41(2)(f): amended, on 1 November 2018, by clause 32 of the Electricity Industry Participation Code Amendment (Code Review Programme) 2018.
Clause 41(5) to (9): inserted, on 1 February 2021, by clause 38 of the Electricity Industry Participation Code Amendment (Metering and Related Registry Processes) 2020.

42 Enclosures

An **ATH** must, before it **certifies** a **metering installation**, ensure that, if a **metering component** in the **metering installation** is housed in a separate enclosure from the **meter** enclosure, the enclosure is—

- (a) appropriate to the environment in which it is located; and
- (b) has a warning label attached stating that the enclosure houses a **metering component**.

Certification of metering components

43 Metering components must be certified

- (1) An **ATH** must, before it **certifies** a **metering installation**, ensure that each **metering component** that is required to be **certified** under this Part and which is in the **metering installation**—
- (a) is **certified** by an **ATH** in accordance with this Part; and
 - (b) since **certification**, has been appropriately stored and not used.
- (2) Despite subclause (1) and clause 26(2), an **ATH** may **certify** a **category 1 metering installation** that contains a **meter** which has been removed from another **category 1 metering installation** (the "previous **metering installation**") if the **ATH**—
- (a) is satisfied that external factors have not affected the accuracy of the **meter**; and
 - (b) has confirmed that it has been no more than 12 months since the **meter** was installed in the previous **metering installation**; and
 - (c) has confirmed that the **meter** was **calibrated** or **recalibrated** before being installed in the previous **metering installation** and after being removed from any other **metering installation** in which the **meter** was previously installed.

Clause 43(1): amended, on 1 February 2016, by clause 37(1) of the Electricity Industry Participation Code

Amendment (Code Review Programme) 2015.
Clause 43(2): substituted, on 1 February 2016, by clause 37(2) of the Electricity Industry Participation Code
Amendment (Code Review Programme) 2015.

Inspection requirements

44 General inspection requirements

- (1) An **ATH** must, when carrying out an inspection of a **metering installation**,—
 - (a) check and confirm that the **data storage device** in the **metering installation** operates in accordance with the requirements of this Part; and
 - (b) check and confirm that the expected remaining lifetime of each battery in the **metering installation** will be reasonably likely to meet or exceed the **metering installation certification** expiry date; and
 - (c) ensure that no modifications under clause 19 have been made to the **metering installation** without the change having been documented and **certification** requirements satisfied; and
 - (d) visually inspect all seals, enclosures, **metering components**, and wiring of the **metering installation** for evidence of damage, deterioration, or tampering; and
 - (e) ensure that the **metering installation** and its **metering components** carry appropriate **certification stickers** in accordance with clause 41; and
 - (f) in the case of a **category 1 metering installation** incorporating a **data storage device**, check and confirm there is no difference between the volume of **electricity** recorded by the master accumulation register of a **data storage device**, and the sum of the **meter** registers.
- (2) An **ATH** must, for each inspection of a **metering installation** that it carries out, prepare an inspection report that details—
 - (a) the checks that were carried out; and
 - (b) the results of the checks; and
 - (c) the **metering installation certification** expiry date; and
 - (d) the serial numbers of each **metering component** in the **metering installation**; and
 - (e) any instances of non-compliance with this Part, and the actions taken to remedy such a breach; and
 - (f) the name and signature of the person who carried out the inspection and the date on which it was signed.
- (3) The **ATH** must, within 10 **business days** of carrying out the inspection, provide the inspection report to the **metering equipment provider** who is responsible for the **metering installation**.
- (4) If an **ATH** has not performed an inspection of a **metering installation** within the specified timeframe under clauses 45(1) or 46(1), the **certification** of the **metering installation** is automatically cancelled on the date by which the **metering installation** was required to have been inspected.
- (5) A **metering equipment provider** must, within 20 **business days** of receiving the inspection report,—
 - (a) undertake a comparison of—

- (i) the information recorded under subclauses (2)(c) and (d); and
- (ii) the information in its own records; and
- (b) investigate and correct any discrepancies found under paragraph (a); and
- (c) update the **registry** with the relevant changes.

Clause 44(4): amended, on 20 December 2021, by clause 33 of the Electricity Industry Participation Code Amendment (Code Review Programme) 2019.

Clause 44(5)(c): amended, on 5 October 2017, by clause 193 of the Electricity Industry Participation Code Amendment (Code Review Programme) 2017.**45** **Category 1 metering installation inspection requirements**

- (1) A **metering equipment provider** must ensure that—
 - (a) an **ATH** has completed an inspection of each **category 1 metering installation** for which the **metering equipment provider** is responsible within the period set out in Table 1 of Schedule 10.1, starting from the date of the **metering installation's** most recent **certification** or inspection; or
 - (b) if the **metering equipment provider** is responsible for any **category 1 metering installations** that were **certified** more than 84 months ago, the **metering equipment provider** inspects a sample of all **category 1 metering installations**.
- (1A) When inspecting a sample of **category 1 metering installations** under subclause (1)(b), the **metering equipment provider** must—
 - (a) complete the inspections each 12 month calendar year between 1 January and 31 December; and
 - (b) perform the first inspection in the same calendar year the oldest **metering installation** reaches 84 months since certification.
- (2) A **metering equipment provider** must, for the purposes of subclause (1)(b), select a sample by—
 - (a) producing a list of all **ICP identifiers** of each **category 1 metering installation** for which it is responsible; and
 - (b) removing from the list of **ICP identifiers**, any **ICP identifier** for a **metering installation** that has been **certified** or inspected in the 84 months prior to 31 December in the year in which the list was produced; and
 - (c) identifying the applicable required minimum sample size set out in Table 8 of Schedule 10.1, based on the number of **metering installations** identified in the list of **ICP identifiers** in produced in accordance with paragraphs (a) and (b); and
 - (d) randomly selecting a sample, of the size required under paragraph (c), from the list produced in accordance with paragraphs (a) and (b).
- (3) A **metering equipment provider** must, before it carries out inspections under subclause (1)(b),—
 - (a) submit a documented process for randomly selecting a sample to the **Authority** at least 2 months before the first date on which it proposes to carry out the inspections; and
 - (b) provide promptly any other information or documentation the **Authority** may reasonably request.
- (4) The **Authority** must, within 2 months of receiving the documented process under subclause (3), advise the **metering equipment provider** that the documented process—
 - (a) has been approved; or
 - (b) has not been approved, providing reasons.

- (5) A **metering equipment provider** must not inspect a sample under this clause unless the **Authority** has approved the documented process.
- (6) A **metering equipment provider** must, for each inspection of a **category 1 metering installation** conducted under subclause (1)(b), keep records that detail—
- (a) any defects identified that have affected the accuracy or integrity of the **raw meter data** recorded by the **metering installation**; and
 - (b) any discrepancies identified under clause 44(5)(b); and
 - (c) relevant characteristics, sufficient to enable reporting that identifies any correlations or relationships between inaccuracy and characteristics (for example the **meter** make, model, and **network** area, for each **metering installation**); and
 - (d) the procedure used, and the lists generated, to select a sample under subclause (2).
- (7) A **metering equipment provider** must, if it believes that a **metering installation** that an **ATH** has inspected under this clause is or could be outside the applicable accuracy tolerances set out in Table 1 of Schedule 10.1, defective, or not fit for purpose,—
- (a) comply with clause 10.43;
 - (b) arrange for an **ATH** to **recertify** the **metering installation** under this Schedule, if the **metering installation** is found to be—
 - (i) outside the applicable accuracy tolerances set out in Table 1 of Schedule 10.1; or
 - (ii) defective; or
 - (iii) not fit for purpose.
- (8) A **metering equipment provider** must, by 1 April in each year, provide to the **Authority** a report in the **prescribed form** that states whether the **metering equipment provider** has, for the previous 1 January to 31 December period, arranged for an **ATH** to inspect each **category 1 metering installation** for which it is responsible—
- (a) under subclause (1)(a), in which case the report must also include, for the period—
 - (i) a list showing the **ICP identifier** for each **ICP** which has a **metering installation** that was due for inspection, the dates by which the **metering installation** was due for inspection, and the date on which it was inspected; and
 - (ii) a summary of the instances of non-compliance of each **category 1 metering installation** inspected; and
 - (iii) the detailed records required under subclauses (6)(a) and (6)(b); or
 - (b) under subclause (1)(b), in which case the report must also include, for the period—
 - (i) the number of **metering installations** identified under subclause (2)(a) to (2)(c); and
 - (ii) a summary of the instances of non-compliance of each **category 1 metering installation** inspected; and
 - (iii) the detailed records required under subclauses (6)(a) and (6)(b).
- (9) The **Authority** may, if it considers that the report provided under subclause (8) indicates that there is a statistically significant number of **metering installations** in the sample which are outside the applicable accuracy tolerances set out in Table 1 of

Schedule 10.1, defective, or not fit for purpose, despite subclause (1)(b), advise the **metering equipment provider** that it must select another sample in accordance with subclause (2) and comply with the applicable requirements of this clause in respect of the sample.

- (10) The **metering equipment provider** must select the additional sample under subclause (9), carry out the required inspections and report to the **Authority** under subclause (8), within 40 **business days** of being advised by the **Authority** under subclause (9).

Clause 45(1)(a) and (b): replaced, on 1 February 2021, by clause 39(1) of the Electricity Industry Participation Code Amendment (Metering and Related Registry Processes) 2020.

Clause 45(1A): inserted, on 1 February 2021, by clause 39(2) of the Electricity Industry Participation Code Amendment (Metering and Related Registry Processes) 2020.

Clause 45(2)(a): amended, on 1 February 2021, by clause 39(3)(a) of the Electricity Industry Participation Code Amendment (Metering and Related Registry Processes) 2020.

Clause 45(2)(b): amended, on 1 February 2016, by clause 38(1) of the Electricity Industry Participation Code Amendment (Code Review Programme) 2015.

Clause 45(2)(b): replaced, on 1 February 2021, by clause 39(3)(b) of the Electricity Industry Participation Code Amendment (Metering and Related Registry Processes) 2020.

Clause 45(2)(c): amended, on 1 February 2016, by clause 38(2) of the Electricity Industry Participation Code Amendment (Code Review Programme) 2015.

Clause 45(2)(d): amended, on 1 February 2016, by clause 38(3) of the Electricity Industry Participation Code Amendment (Code Review Programme) 2015.

Clause 45(10): amended, on 29 August 2013, by clause 45 of the Electricity Industry Participation (Metering Arrangements) Code Amendment 2011, Amendment 2013 (No 2).

46 **Category 2 metering installation or higher category of metering installation inspection requirements**

- (1) A **metering equipment provider** must ensure that each **category 2 metering installation**, or higher category of **metering installation**, for which it is responsible is inspected by an **ATH** at least once within the applicable period set out in Table 1 of Schedule 10.1 starting from the date of the **metering installation's** most recent **certification**.
- (2) An **ATH** must, when conducting an inspection of a **category 2 metering installation**, or higher category of **metering installation**, and in addition to complying with clause 44, conduct the following checks:
- (a) a visual inspection of each **metering component** in the **metering installation** for damage, tampering, or defect; and
 - (b) if the current transformer can be safely accessed, check the position of the current transformer tap to ensure it is still appropriate for the expected maximum current for the **metering installation**; and
 - (c) check for the presence of appropriate voltages at the **metering installation**; and
 - (d) check the voltage circuit alarms and fault indicators.

Sealing

47 **Sealing requirements**

- (1) For the purposes of this clause and clause 48, a reference to something being sealed includes being contained in a sealed enclosure.
- (2) An **ATH** must, before it **certifies** a **metering installation**, ensure that each **metering component** in the **metering installation** that could reasonably be expected to affect the

- accuracy or reliability of the **metering installation**, is sealed.
- (3) An **ATH** must, before leaving a **metering installation** unattended, ensure that each part and connection of a **data storage device** that is contained in, or attached to, the **metering installation** is sealed.
 - (4) Subclause (3) does not apply to a port for on-site reading that is not capable of carrying out any other function.
 - (5) An **ATH** must, before it **certifies** a **metering installation**, ensure that the main switch cover is sealed if the main switch—
 - (a) is on the supply side of the **metering installation**; and
 - (b) has provision for sealing.
 - (6) An **ATH** must, when applying a seal to a **metering component** in an enclosure, attach a label in a prominent position inside the enclosure, warning—
 - (a) of the presence of a sealed **metering component** in the enclosure; and
 - (b) that care must be taken not to disturb the connections to the **metering component**.
 - (7) An **ATH** must use a sealing system that enables the following information to be determined:
 - (a) the **ATH** who affixed the seal; and
 - (b) the person (or the sealing tool) who applied the seal; and
 - (c) when the seal was applied.

48 Removal or breakage of seals

- (1) A **participant** who removes or breaks a seal without authorisation of the **metering equipment provider** responsible for the **metering installation**, other than in accordance with subclauses (1A) to (1F), must, within 10 **business days** of removing or breaking the seal,—
 - (a) advise the **metering equipment provider** of—
 - (i) the removal or breakage; and
 - (ii) the reason for the removal or breakage; and
 - (b) reimburse the **metering equipment provider** for the cost of reinstating the seal and **recertification** if required by the **metering equipment provider**.
- (1A) A **distributor** may interfere with a **metering installation** without authorisation of the **metering equipment provider** responsible for the **metering installation** to reset a load control switch contained within a load control device or bridge or unbridge a load control switch if—
 - (a) the load control switch does not control a **time block meter channel**; and
 - (b) the **distributor** provides the load control signal to the load control device.
- (1B) A **distributor** that removes or breaks a seal in accordance with subclause (1A) must—
 - (a) ensure that the personnel it uses to remove or break the seal are qualified or trained to a level sufficient to ensure they can safely remove or break the seal, bridge and unbridge the load control switch, and replace the seal in accordance with this Code; and
 - (b) replace the seal with its own seal and have a process for tracing the new seal to the personnel that removed or broke the seal for the **distributor**; and

- (c) advise the **trader** and **metering equipment provider** responsible for the **ICP** at which the **metering installation** is located if the load control switch has been bridged or unbridged.
- (1C) A **trader** that is advised under subclause (1B)(c) must, if the **profile** code has changed, advise the **registry manager** of the updated **profile** code for the **ICP** in accordance with clause 10 of Schedule 11.1.
- (1D) A **trader** may remove or break a seal without authorisation of the **metering equipment provider** responsible for the **metering installation** to reset a load control switch or bridge or unbridge a load control switch if the load control switch does not control a **time block meter channel**.
- (1E) A **trader** may remove or break a seal in a **metering installation** without authorisation of the **metering equipment provider** responsible for the **metering installation**—
 - (a) to **electrically connect** the load or **generation** measured by the **meter** if the load or **generation** has been **electrically disconnected** at the **meter**; or
 - (b) to **electrically disconnect** the load or **generation** measured by the **meter** if the **trader** has exhausted all other appropriate methods of **electrical disconnection**; or
 - (c) to bridge the **meter**.
- (1F) A **trader** that removes or breaks a seal in accordance with subclause (1D) or (1E) must—
 - (a) ensure that the personnel it uses to remove or break the seal are qualified or trained to a level sufficient to ensure they can safely remove or break the seal, perform the permitted work described in subclause (1D) or (1E), and replace the seal, in accordance with this Code; and
 - (b) replace the seal with its own seal and have a process for tracing the new seal to the personnel that removed or broke the seal for the **trader**; and
 - (c) if the **profile** code has changed, advise the **registry manager** of the updated **profile** code for the **ICP** in accordance with clause 10 of Schedule 11.1; and
 - (d) advise the **metering equipment provider** that is responsible for the **metering installation** in which the seal is located that the seal has been broken and what permitted work has been performed.
- (1G) A **metering equipment provider** that has been advised under subclause (1B)(c) or (1F)(d) must advise the **registry manager** of the updated **meter** register content code for the relevant **meter** channel if required.
- (2) A **participant** who is required under subclause (1)(b) to reimburse the cost of reinstating and **recertifying** a seal, must do so within 10 **business days** of the **metering equipment provider** advising the **participant** of the cost.
- (3) A **participant** who becomes aware that another person has removed or broken a seal, must, within 3 **business days** of becoming aware, advise the **metering equipment provider** who is responsible for the **metering installation**.
- (4) A **metering equipment provider** must, if it is advised under subclauses (1) or (3)—
 - (a) use all reasonable endeavours to ascertain—
 - (i) who removed or broke the seal; and
 - (ii) the reason for the removal or breakage; and

- (b) arrange for an **ATH** to carry out, as soon as practicable, an inspection of the removal or breakage, and to determine any work required to remedy the removal or breakage.
- (5) A **metering equipment provider** must make the arrangements required under subclause (4)(b) within—
 - (a) **3 business days** of being advised under subclauses (1) or (3), if the **metering installation** is category 3 or higher; or
 - (b) **10 business days** of being advised under subclauses (1) or (3), if the **metering installation** is a **category 2 metering installation**; or
 - (c) **20 business days** of being advised under subclauses (1) or (3), if the **metering installation** is a **category 1 metering installation**.
- (6) An **ATH** must, when investigating an unauthorised removal or breakage under subclause (4)(b), assess the accuracy and continued integrity of the **metering installation** and—
 - (a) if, in its opinion, the accuracy and continued integrity is unaffected, replace the removed or broken seals; or
 - (b) if, in its opinion, the accuracy and continued integrity is affected, replace the removed or broken seal and advise the **metering equipment provider** under clause 10.43.
- (7) If subclause (6)(b) applies, the **certification** of the **metering installation** is automatically cancelled from the date on which a **participant** became aware, or should have become aware, of the removed or broken seal.
- (8) If a person removes or breaks a seal without authorisation of the **metering equipment provider** responsible for the **metering installation** in which the seal is located or not in accordance with subclauses (1A) to (1F), the **metering equipment provider** or the **ATH** responsible for **certifying** the **metering component** are not liable for any breach of this Code that results from the person's actions, provided the **metering equipment provider** or **ATH** can prove the seal had not been removed or broken when the **metering equipment provider** or **ATH** last performed work at the **metering installation**.

Clause 48(1): amended, on 1 February 2021, by clause 40(1) of the Electricity Industry Participation Code Amendment (Metering and Related Registry Processes) 2020.

Clauses 48(1A) to (1G): inserted, on 1 February 2021, by clause 40(2) of the Electricity Industry Participation Code Amendment (Metering and Related Registry Processes) 2020.

Clause 48(8): inserted, on 1 February 2021, by clause 40(3) of the Electricity Industry Participation Code Amendment (Metering and Related Registry Processes) 2020.

Schedule 10.8 Metering component requirements

cl 10.20, 10.38 and 10.42

Meters

1 Meter certification requirements

- (1) An **ATH** must, before it **certifies a meter**, ensure that—
- (a) an **approved test laboratory** has—
 - (i) conducted **type-testing** that the **ATH** considers appropriate for the model and version of **meter**; and
 - (ii) produced a **type-test** certificate that—
 - (A) confirms the **meter's** technical characteristics; and
 - (B) confirms the range of environmental conditions within which the **meter** has been proven accurate and reliable; and
 - (C) confirms that the **meter** performs the functions for which it was designed; and
 - (D) confirms that the **meter** complies with the requirements of this Part; and
 - (E) records the tests undertaken by the **approved test laboratory** and the reasons why the **ATH** considers that they are appropriate; and
 - (b) the **meter** has a current **calibration report** issued by an **approved calibration laboratory** or an **ATH** approved to carry out **calibration** under Schedule 10.3; and
 - (c) the **meter calibration report**—
 - (i) confirms that the **meter** complies with the standards listed in Table 5 of Schedule 10.1; and
 - (ii) records any tests the **ATH** has performed to confirm compliance under subparagraph (i) and the results of those tests; and
 - (iii) confirms that the **meter** has passed the tests; and
 - (iv) records any recommendations on **error compensation**; and
 - (v) includes any manufacturer's **calibration** test reports; and
 - (d) it produces a **meter certification report** that includes—
 - (i) the date on which it **certified** the **meter**; and
 - (ii) the **certification** validity period for the **meter** for each category of **metering installation** that the **meter** may be used in; and
 - (iia) if the **certification** validity period referred to in subparagraph (ii) is less than the maximum **certification** validity period permitted under Table 1 of Schedule 10.1, the reasons for the shorter **certification** validity period; and
 - (iii) the maintenance requirements for the **meter**; and
 - (iv) the **meter calibration report**; and
 - (v) whether the **certification** was based on batch test certificates; and
 - (vi) if the **certification** was based on batch test certificates, confirmation that the manufacturer's batch testing facility is, in the **ATH's** opinion, of an

- acceptable standard; and
- (e) the percentage values of current set out in Table 6 or Table 7 of Schedule 10.1, as applicable, are relative to the **meter's** base or rated current (I_b or I_n) as appropriate, and this current is selected at a level appropriate for the **metering installation** in which the **meter** is to be installed.
- (2) The **certification** validity period referred to in subclause (1)(d)(ii) must not be greater than the maximum **certification** validity period set out in Table 1 of Schedule 10.1 for the relevant categories of **metering installations** in which the **meter** may be used.
- Clause 1(1)(b): amended, on 19 December 2014, by clause 23(1) of the Electricity Industry Participation Code Amendment (Minor Code Amendments) (No 3) 2014.
- Clause 1(1)(c)(ii): amended, on 19 December 2014, by clause 23(2) of the Electricity Industry Participation Code Amendment (Minor Code Amendments) (No 3) 2014.
- Clause 1(d)(iia): inserted, on 1 February 2021, by clause 41(a) of the Electricity Industry Participation Code Amendment (Metering and Related Registry Processes) 2020.
- Clause 1(2): amended, on 1 February 2021, by clause 41(b) of the Electricity Industry Participation Code Amendment (Metering and Related Registry Processes) 2020.

Measuring transformers

2 Measuring transformer certification requirements

- (1) An **ATH** must, before it **certifies** a **measuring transformer**,—
- (a) ensure, by testing, that a current **calibration report** sets out the **measuring transformer's** errors at a range of primary values at their rated burdens; and
- (b) that is a multi-tap current transformer, carry out the **calibration** tests and only **certify** the transformer for the ratios that have been **calibrated** if the test is passed; and
- (c) *[Revoked]*
- (d) determine the **measuring transformer certification** validity period under clause 3(c)(ii); and
- (e) determine the range, including highest and lowest values, that the in-service burden must be within to ensure the **measuring transformer** remains accurate, by using one or more of the following:
- (i) the **measuring transformer's** nameplate rating;
- (ii) the **calibration report** for the **measuring transformer**;
- (iii) the manufacturer's documentation for the **measuring transformer**;
- (iv) the standard set out in Table 5 of Schedule 10.1 the **measuring transformer** was manufactured to.
- (2) An **ATH** must, before it **certifies** an epoxy insulated current transformer, ensure that the **certification** tests allow for, and the **metering installation certification report** shows, the current transformer's age, temperature, and batch.

Clause 2(1)(c): amended, on 29 August 2013, by clause 46 of the Electricity Industry Participation (Metering Arrangements) Code Amendment 2011, Amendment 2013 (No 2).

Clause 2(1)(c): substituted, on 19 December 2014, by clause 24 of the Electricity Industry Participation Code Amendment (Minor Code Amendments) (No 3) 2014.

Clause 2(1)(c): revoked, on 1 February 2021, by clause 42(a) of the Electricity Industry Participation Code Amendment (Metering and Related Registry Processes) 2020.

Clause 2(1)(d): amended, on 1 February 2021, by clause 42(b) of the Electricity Industry Participation Code Amendment (Metering and Related Registry Processes) 2020.

Clause 2(1)(e): inserted, on 1 February 2021, by clause 42(c) of the Electricity Industry Participation Code Amendment (Metering and Related Registry Processes) 2020.

3 Measuring transformer certification report

An **ATH** must, before it **certifies** a **measuring transformer**, ensure that—

- (a) the **measuring transformer** has a current **calibration report** issued by an **approved calibration laboratory** or an **ATH** approved to carry out **calibration** under Schedule 10.3; and
- (b) the **measuring transformer calibration report**—
 - (i) confirms that the **measuring transformer** complies with the standards listed in Table 5 of Schedule 10.1; and
 - (ii) records any tests the **ATH** has performed to confirm compliance under subparagraph (i) and the results of those tests; and
 - (iii) confirms that the **measuring transformer** has passed the tests; and
 - (iv) records any recommendations made by the **ATH** on **error compensation**; and
 - (v) includes any manufacturer's **calibration** test reports; and
- (c) it produces a **measuring transformer certification report** that includes—
 - (i) the date on which it **certified** the **measuring transformer**; and
 - (ii) the **certification** validity period for the **measuring transformer** which must be no more than 120 months; and
 - (iii) the **measuring transformer calibration report**; and
 - (iv) whether the **certification** was based on batch test certificates; and
 - (v) if the **certification** was based on batch test certificates, confirmation that the manufacturer's batch testing facility is, in the **ATH's** opinion, of an acceptable standard; and
 - (vi) the range, including highest and lowest values, that the in-service burden must be within; and
- (d) it confirms that it has inspected the manufacturer's test certificates, and carried out any additional tests it considers necessary, to satisfy itself that the **measuring transformer** meets the accuracy requirements of this Part.

Clause 3(a): amended, on 19 December 2014, by clause 25(1) of the Electricity Industry Participation Code Amendment (Minor Code Amendments) (No 3) 2014.

Clause 3(b)(ii): amended, on 19 December 2014, by clause 25(2) of the Electricity Industry Participation Code Amendment (Minor Code Amendments) (No 3) 2014.

Clause 3(c)(vi): inserted, on 1 February 2021, by clause 43 of the Electricity Industry Participation Code Amendment (Metering and Related Registry Processes) 2020.

Control devices

4 Control device certification report

- (1) An **ATH** must, before it **certifies** a new **control device**, produce a **certification report** that—
 - (a) confirms that the **control device** complies with the applicable standards listed in Table 5 of Schedule 10.1; and
 - (b) includes the details and results of any test that the **ATH** has carried out to confirm compliance under paragraph (a); and
 - (c) confirms that the **control device** has passed such tests.
- (2) An **ATH** must, before it **certifies** an existing installed **control device**, produce a **certification report** that—

- (a) confirms that the **control device** is fit for purpose; and
- (b) confirms the **control device certification** validity period that the **ATH** considers appropriate, which must be no more than 180 months.

Clause 4: substituted, on 29 August 2013, by clause 47 of the Electricity Industry Participation (Metering Arrangements) Code Amendment 2011, Amendment 2013 (No 2).

Clause 4(1)(b): amended, on 15 May 2014, by clause 20 of the Electricity Industry Participation (Minor Code Amendments) Code Amendment 2014.

Data storage devices

5 Data storage device certification requirements

- (1) An **ATH** must, before it **certifies** a **data storage device** used for storing information that is used for the purposes of Part 15, ensure that—
 - (a) an **approved test laboratory** has—
 - (i) conducted **type-testing** that the **ATH** considers appropriate for the model and version of **data storage device**; and
 - (ii) produced a **type-test** certificate that—
 - (A) confirms the **data storage device's** technical characteristics; and
 - (B) confirms the range of environmental conditions within which the **data storage device** has been proven accurate and reliable; and
 - (C) confirms that the **data storage device** performs the functions for which it was designed; and
 - (D) confirms that the **data storage device** complies with this Part; and
 - (E) records the tests undertaken by the **approved test laboratory** to confirm compliance under sub-subparagraph (D) and the reasons why the **ATH** considers that they are appropriate; and
 - (b) it produces a **certification report** that—
 - (i) confirms the **data storage device** complies with the applicable standards listed in Table 5 of Schedule 10.1; and
 - (ii) records the tests the **ATH** has performed to confirm compliance with subparagraph (i) and the results of those tests; and
 - (iii) confirms that the **data storage device** has passed the tests; and
 - (iv) includes the date on which it **certified** the **data storage device**; and
 - (v) includes the **certification** validity period for the **data storage device** for each category of **metering installation** in which the **data storage device** may be used; and
 - (vi) records the maintenance requirements for the **data storage device**; and
 - (vii) confirms that each period of data is identifiable or deducible by both date and time on **interrogation**; and
 - (viii) confirms that the time and date of the following event conditions are recorded in an **event log**:
 - (A) a loss of the power supply to the **data storage device**; and
 - (B) critical internal alarms such as memory integrity checking, battery low, battery failed, and tampering; and
 - (C) phase failure to the **meter**, if the **data storage device** is integral to the

- meter;** and
 - (D) any **software** configuration changes; and
 - (E) results of time setting comparisons and corrections; and
 - (F) the transition from, and to, **New Zealand daylight time**, if the **data storage device** operates in **New Zealand daylight time**; and
 - (ix) confirms that the **data storage device** has the available memory capacity required by the **type-test**; and
 - (x) confirms that the **data storage device** has the functionality—
 - (A) to validate instructions from an **interrogation** system; and
 - (B) for time comparisons and corrections, in response to a valid instruction; and
 - (xi) confirms that all information logged is referenced to **New Zealand Standard Time** or **New Zealand daylight time**; and
 - (xii) confirms that the **data storage device** has data loss protection providing a continued clock and memory operation for a continuous period of at least 15 days when the power supply to the **data storage device** is lost.
- (2) The **data storage device certification** validity period referred to in subclause (1)(b)(v) must be—
 - (a) no more than 180 months, if the **data storage device** is a discrete **metering component**; or
 - (b) the same as the **meter certification** validity period, if the **data storage device** is integral to the **meter**.
- (3) Despite subclause (1)(b)(ix), the memory capacity of the **data storage device** must not be less than 15 days.
- (4) For the purposes of subclause (1), a new version of the **data storage device** includes any change to the specification, hardware, or metrology **software** of the **data storage device**.

Wiring

6 Wiring

- (1) An **ATH** must, before it **certifies** a **metering installation**, ensure that all wiring in the **metering installation** is—
 - (a) suitable for the environment in which the **metering installation** is located; and
 - (b) fit for purpose; and
 - (c) securely fastened; and
 - (d) compliant with all applicable requirements and enactments.
- (2) An **ATH** must, before it **certifies** a **metering installation**, ensure that the wiring between **metering components** in the **metering installation**—
 - (a) is run as directly as practicable; and
 - (b) is appropriately sized and protected; and
 - (c) does not, to the extent practicable, include intermediate joints for any **measuring transformer** circuits; and
 - (d) subject to subclause (4), includes conductors that are clearly and permanently

identified, by the use of any 1 or more of the following:

- (i) colour coding;
 - (ii) marker ferrules;
 - (iii) conductor numbering.
- (3) For the purposes of subclause (2)(c), if it is not practicable to exclude intermediate joints for any **measuring transformer** circuits, the **ATH** must ensure that the intermediate joints are—
- (a) sealed or in a sealed enclosure; and
 - (b) located in a secure position; and
 - (c) recorded in the **metering installation certification report**.
- (4) The **ATH** must, if the wiring is in a **metering installation** and does not comply with subclause (2)(d)—
- (a) ensure, by testing, that the wiring has been correctly installed; and
 - (b) record the nature of the test or the tests, and the results of the test or tests, in the **metering installation certification report**.

Fuses and circuit breakers

7 Fuses and circuit breakers

An **ATH** must, before it **certifies** a **metering installation**, ensure that all fuses and **circuit breakers** that are part of the **metering installation** are—

- (a) appropriately rated for the electrical duty and discrimination required; and
- (b) clearly labelled and—
 - (i) sealed; or
 - (ii) located in sealed enclosures.

Certification stickers

8 Metering component certification stickers

- (1) An **ATH** must, when **certifying** a **metering component** under this Part, confirm the **certification** by attaching a **metering component certification sticker** to the **metering component** or, if not practicable, provide the sticker with the **metering component**.
- (2) An **ATH** referred to in subclause (1) must ensure that a **metering component certification sticker** shows—
- (a) the name of the **metering component** owner (if available); and
 - (b) if the **metering component** is a **meter** or a **measuring transformer**, the name of the **ATH** or the **approved calibration laboratory** who **calibrated** the **metering component**; and
 - (c) the name of the **ATH** who **certified** the **metering component**; and
 - (d) the date on which the **metering component** was **certified**; and
 - (e) the initials or other unique identifier of the person who carried out the **certification** of the **metering component**.
- (3) An **ATH** must ensure that a **certification sticker** is—
- (a) made of weather-proof material; and
 - (b) permanently attached; and

- (c) filled out using permanent markings.
- (4) If an **ATH** certifies the **metering component** on the same day it certifies the **metering installation** that the **metering component** is installed in, the **ATH** may combine the **metering component certification sticker** under subclause (1) and the **metering installation certification sticker** under clause 41 of Schedule 10.7 and attach it to the **metering installation** in accordance with clause 41 of Schedule 10.7.

Clause 8(4): inserted, on 1 February 2021, by clause 44 of the Electricity Industry Participation Code Amendment (Metering and Related Registry Processes) 2020.

Onsite calibration and certification

9 Onsite calibration and certification

- (1) A **certifying ATH** may only **calibrate** a **metering component** onsite—
- (a) in the **metering component's** normal working environment; and
 - (b) by—
 - (i) measuring the influence of all onsite variables and including their estimated effects in the **uncertainty** calculation; and
 - (ii) ensuring that—
 - (A) the effects of any departures from the **reference conditions** specified in the relevant standards listed in Table 5 of Schedule 10.1 can accurately and reliably be calculated; and
 - (B) the **metering installation**, in which the **metering component** is incorporated, is within the applicable accuracy tolerances set out in Table 1 of Schedule 10.1 after taking into account all known influences including temperature and temperature co-efficient measurements.
- (2) If an **ATH** **calibrates** a **metering component** onsite using manual methods, computers, or automated equipment for the capture, processing, manipulation, recording, reporting, storage, or retrieval of **calibration** data, it must ensure that its computer **software**—
- (a) is documented in the **ATH's** procedures; and
 - (b) can manipulate the variables that affect the performance of the **metering component** in a manner that will produce results that would correctly indicate the level of compliance of the **metering component** with this Code.
- (3) An **ATH** who **certifies** a **metering component** onsite must include in the **metering component certification report** confirmation that—
- (a) it has calculated the **uncertainty** of measurement taking into account all environmental factors for both the **metering component** being **calibrated** and the **working standards**; and
 - (b) the calculation of the **uncertainty** referred to in paragraph (a) comprises all **uncertainties** in the chain of **calibration**; and
 - (c) the **ATH** has used a **calibration** procedure to **calibrate** the **metering component** that—
 - (i) was included in the **ATH's** most recent **audit**; and
 - (ii) is appropriate for onsite **calibration**; and
 - (iii) includes the methodologies, calculations, and assumptions used by the **ATH**

- in determining the **uncertainty**; and
- (d) the **ATH** believes the methodologies, calculations, and assumptions are appropriate, including reasons for that belief.

Electricity Industry Participation Code 2010

Part 11 Registry information management

Contents

- 11.1 Contents of this Part
- 11.2 Requirement to provide complete and accurate information
- 11.2A Use of contractors
- 11.3 Certain points of connection must have ICP identifiers
- 11.4 Distributors must create ICP identifiers for ICPs
- 11.5 Participants may request that distributors create ICP identifiers for ICPs
- 11.6 ICP status
- 11.7 Provision of ICP information
- 11.8 Provision of and changes to ICP information and NSP information by participants
- 11.8A Metering equipment providers to provide registry metering records to registry manager
- 11.8B Metering equipment providers to arrange for regular audits
- 11.9 *[Revoked]*
- 11.10 Distributors to arrange for regular audits
- 11.11 Authority and participant requested audits
- 11.12 *[Revoked]*
- 11.13 *[Revoked]*
- 11.14 Process for maintaining shared unmetered load
- 11.15 Process for customer or embedded generator switching
- 11.15AA Restrictions during switch protected period
- 11.15AB Retailer may communicate with customers for certain purposes
- 11.15AC Restrictions on use of customer information by retailer prior to or during switch protected period
- 11.15AD *[Revoked]*
- 11.15A Application of Schedule 11.4
- 11.15B Trader contracts with customers to permit assignment by Authority
- 11.15C Process for trader events of default
- 11.16 Trader to ensure arrangements for distribution services and metering
- 11.17 Connecting ICP that is not also NSP
- 11.18 Trader responsibility for ICP
- 11.18A Registry manager to advise metering equipment providers
- 11.18B Metering equipment provider responsibility for metering installation for ICP
- 11.19 Authority to specify timeframes and formats of information
- 11.20 Registry must be available between 0730 and 1930 each day
- 11.21 Confirmation of receipt of data
- 11.22 Registry manager must maintain register of information
- 11.23 Reports from registry manager
- 11.24 Registry manager delivers reports to specific participants
- 11.25 Reports to clearing manager, system operator or reconciliation manager
- 11.26 Reports to reconciliation manager
- 11.27 Reports to Authority

- 11.28 Access to registry
- 11.29 Registry information change
- 11.30 Use of ICP identifier on invoices
- 11.30A Provision of information on dispute resolution scheme
- 11.30B Provision of information on electricity plan comparison site
- 11.30C Specific requirements for information provided on websites and by other electronic means
- 11.30D Limitations on required information disclosure under clause 11.30A and 11.30B
- 11.30E Meaning of “related entity”
- 11.31 Customer and embedded generator queries
- 11.32 Reliance on registry
- Access by consumers to information about their own electricity consumption*
- 11.32A Retailers must give information about consumer electricity consumption
- 11.32B Requests for information
- 11.32C Retailers must give written notice to consumers of availability of information
- 11.32D Information security
- 11.32E Agents
- 11.32EA Retailer actions on receipt of requests from agents
- 11.32EB Decisions on requests
- 11.32EC Requirements for agents who are participants
- 11.32ED Additional requirements on retailers for authorisations in prescribed form and requests received through the EIE System
- 11.32EE Requirements for written authorities under Schedule 11.6
- 11.32EF Revocation of authority
- 11.32EG Authority may prescribe EIE system
- 11.32F Authority to publish procedures for responding to requests for consumption information
- 11.32G Retailers must provide information about generally available retail tariff plans
- 11.33 *[Expired]*
- 11.34 *[Expired]*
- 11.35 *[Expired]*
- 11.36 *[Expired]*

Schedule 11.1

Creation and management of ICPs, ICP identifiers and NSPs

ICPs and ICP identifiers

Provision of ICP Information to the registry manager

Management of ICP status

Updating registry standing information

Schedule 11.2

Transfer of ICPs between distributors' networks

Schedule 11.3

Switching

Standard switching process

Switch move process

Half-hour switching process
Withdrawing a switch request
Exchange of information

Schedule 11.4

Metering equipment provider switching and registry metering records

Schedule 11.5

Process for trader event of default

Schedule 11.6

Forms for authorisation of an Agent to request consumption information

11.1 Contents of this Part

This Part—

- (a) provides for the management of information in the **registry**; and
- (b) prescribes a process for switching **ICPs** between **traders**; and
- (ba) prescribes a period of protection for **gaining retailers** during which a **losing retailer** may not approach a customer to persuade the customer to stay with the **losing retailer** or to switch back to the **losing retailer**; and
- (bb) imposes restrictions on the use of customer information held by a **losing retailer** during a **switch protected period**; and
- (c) prescribes a process for a **distributor** to change the record in the **registry** of an **ICP** so that the **ICP** is recorded as being usually connected to an **NSP** in the **distributor's network**; and
- (d) prescribes a process for switching responsibility for **metering installations** for **ICPs** between **metering equipment providers**; and
- (e) prescribes a process for dealing with **trader events of default**; and
- (f) requires **retailers** to give **consumers** information about their own consumption of **electricity**; and
- (g) requires **retailers** to give information about their **generally available retail tariff plans** to any person on request.

Compare: Electricity Governance Rules 2003 rule 1 part E

Clause 11.1(a) and (c): amended, on 5 October 2017, by clause 194 of the Electricity Industry Participation Code Amendment (Code Review Programme) 2017.

Clause 11.1(b): amended, on 1 November 2018, by clause 33 of the Electricity Industry Participation Code Amendment (Code Review Programme) 2018.

Clause 11.1(ba) and (bb): inserted, on 31 March 2020, by clause 5 of the Electricity Industry Participation Code Amendment (Prohibition of Save and Win-Back Approaches by Losing Retailers During a Switch Protected Period) 2020.

Clause 11.1(c): amended, on 23 February 2015, by clause 75 of the Electricity Industry Participation Code Amendment (Distributed Generation) 2014.

Clause 11.1(d): inserted, on 29 August 2013, by clause 6 of the Electricity Industry Participation (Metering Arrangements) Code Amendment 2011.

Clause 11.1(e): inserted, on 16 December 2013, by clause 5 of the Electricity Industry Participation (Managing Retailer Default Situations) Code Amendment 2013.

Clause 11.1(e): amended, on 28 February 2015, by clause 5 of the Electricity Industry Participation Code Amendment (Trader Default) 2014.

Clause 11.1(e): amended, on 1 February 2016, by clause 4(1) of the Electricity Industry Participation Code Amendment (Access to Retail Data) 2014.

Clause 11.1(f): inserted, on 1 February 2016, by clause 4(2) of the Electricity Industry Participation Code Amendment (Access to Retail Data) 2014.

Clause 11.1(f): amended, on 1 February 2016, by clause 5(1) of the Electricity Industry Participation Code Amendment (Access to Retail Tariff Information) 2015.

Clause 11.1(g): inserted, on 1 February 2016, by clause 5(2) of the Electricity Industry Participation Code Amendment (Access to Retail Tariff Information) 2015.

11.2 Requirement to provide complete and accurate information

- (1) A **participant** must take all practicable steps to ensure that information that the **participant** is required to provide to any person under this Part (including customers) is—
 - (a) complete and accurate; and
 - (b) not misleading or deceptive; and
 - (c) not likely to mislead or deceive.
- (2) If a **participant** becomes aware that the information the **participant** provided under this Part does not comply with subclause (1)(a) to (c), even if the **participant** has taken all practicable steps to ensure that the information complies, the **participant** must, as soon as practicable, provide such further information as is necessary to ensure that the information complies with subclause (1)(a) to (c).

Compare: Electricity Governance Rules 2003 rule 1A part E

Clause 11.2(1): amended, on 31 March 2020, by clause 6 of the Electricity Industry Participation Code Amendment (Prohibition of Save and Win-Back Approaches by Losing Retailers During a Switch Protected Period) 2020.

Clause 11.2(2): substituted, on 19 December 2014, by clause 26 of the Electricity Industry Participation Code Amendment (Minor Code Amendments) (No 3) 2014.

11.2A Use of contractors

- (1) A **participant** may perform its obligations and exercise its rights under this Part by using a contractor.
- (2) A **participant** who uses a contractor to perform the **participant's** obligation under this Part—
 - (a) remains responsible and liable for, and is not released from the obligation or any other obligation under this Part; and
 - (b) cannot assert that it is not responsible or liable for the obligation on the ground that the contractor—
 - (i) has done or not done something; or
 - (ii) has failed to meet a relevant standard; and
 - (c) must ensure that the contractor has at least the specified level of skill, expertise, experience, or qualification that the **participant** would be required to have if it were performing the obligation itself.
- (3) If a **participant** is a party to a contract or arrangement containing a provision, or part of a provision, which is inconsistent with this Part, the provision, or part of the provision, has no effect.

Clause 11.2A: inserted, on 29 August 2013, by clause 7 of the Electricity Industry Participation (Metering Arrangements) Code Amendment 2011.

11.3 Certain points of connection must have ICP identifiers

- (1) This clause applies to the following:
 - (a) a **trader** who has agreed to purchase **electricity** from an **embedded generator** or sell **electricity** to a **consumer**;
 - (b) an **embedded generator** who sells **electricity** directly to the **clearing manager**;

- (c) a **direct purchaser** connected to a **local network** or an **embedded network**:
 - (d) an **embedded network** owner in relation to a **point of connection** on an **embedded network** that is settled by differencing:
 - (e) a **network** owner in relation to a **shared unmetered load point of connection** to the **network** owner's **network**:
 - (f) a **network** owner in relation to a **point of connection** between the **network** owner's **network** and an **embedded network**.
- (2) A **participant** to whom this clause applies must, before the **participant** assumes responsibility for a **point of connection** described in subclause (3) on a **local network** or **embedded network**, obtain an **ICP identifier** for the **point of connection**.
- (3) The **points of connection** for which **ICP identifiers** must be obtained under subclause (2) are **points of connection** at which any of the following occurs:
- (a) a **consumer** purchases **electricity** from a **trader**:
 - (b) a **trader** purchases **electricity** from an **embedded generator**:
 - (c) a **direct purchaser** purchases **electricity** from the **clearing manager**:
 - (d) an **embedded generator** sells **electricity** directly to the **clearing manager**:
 - (e) a **network** is settled by differencing:
 - (f) there is a **distributor** status **ICP**—
 - (i) at the **point of connection** between an **embedded network** and the **distributor's network**; or
 - (ii) at the **point of connection** of **shared unmetered load**.

Compare: Electricity Governance Rules 2003 rule 2 part E
Clause 11.3(1)(c): amended, on 23 February 2015, by clause 75 of the Electricity Industry Participation Code Amendment (Distributed Generation) 2014.
Clause 11.3(1)(c): amended, on 5 October 2017, by clause 195 of the Electricity Industry Participation Code Amendment (Code Review Programme) 2017.

11.4 Distributors must create ICP identifiers for ICPs

- (1) Each **distributor** must create an **ICP identifier** in accordance with clause 1 of Schedule 11.1 for each **ICP** on each **network** for which the **distributor** is responsible.
- (2) A **distributor** must create an **ICP identifier** for the **point of connection** at which an **embedded network** connects to the **distributor's network** in accordance with subclause (1).
- (3) An **ICP identifier** for an **ICP** may not be changed.

Compare: Electricity Governance Rules 2003 rule 3 part E

11.5 Participants may request that distributors create ICP identifiers for ICPs

- (1) A **participant** to whom clause 11.3 applies may request that a **distributor** create an **ICP identifier** for an **ICP** on a **network** for which the **distributor** is responsible.
- (2) A **participant** that is a **trader** may make a request under subclause (1) only if the **trader** has,—
 - (a) in the case of a **trader** to whom Schedule 12A.1 or Schedule 12A.3 of Part 12A applies, a **distributor agreement** with the **distributor** in accordance with clause 11.16; or
 - (b) for all other **traders**, an arrangement with the **distributor** for **distribution** services in accordance with clause 11.6.

- (3) A **distributor** to whom a request is made must, within 3 **business days** of receiving the request, create a new **ICP identifier** for each **ICP** to which the request relates in accordance with clause 1 of Schedule 11.1, or advise the **participant** of the **distributor's** reasons for not complying with the request.

Compare: Electricity Governance Rules 2003 rule 4 part E

Clause 11.5(2): amended, on 1 February 2016, by clause 39 of the Electricity Industry Participation Code Amendment (Code Review Programme) 2015.

Clause 11.5(2): replaced, on 20 July 2020, by clause 5 of the Electricity Industry Participation Code Amendment (Default Distributor Agreement) 2020.

11.6 ICP status

The **participant** specified in clause 12 of Schedule 11.1 must manage the status of an **ICP** in accordance with clause 12 of Schedule 11.1.

Compare: Electricity Governance Rules 2003 rule 5 part E

11.7 Provision of ICP information

- (1) A **distributor** whose **network** includes 1 or more **ICPs** must provide information about each of those **ICPs** to the **registry manager** in accordance with Schedule 11.1.
- (2) A **trader** must provide information about each **ICP** at which the **trader** trades **electricity** to the **registry manager** in accordance with Schedule 11.1.

Compare: Electricity Governance Rules 2003 rule 6 part E

Clause 11.7(1) and (2): amended, on 5 October 2017, by clause 196 of the Electricity Industry Participation Code Amendment (Code Review Programme) 2017.

11.8 Provision of and changes to ICP information and NSP information by participants

- (1) This clause applies if—
- an **NSP** is to be created or **decommissioned**; or
 - a **distributor** wishes to change the record in the **registry** of an **ICP** that is not recorded as being usually connected to an **NSP** in the **distributor's network**, so that the **ICP** is recorded as being usually connected to an **NSP** in the **distributor's network**.
- (2) The **participant** specified in clause 25(3) of Schedule 11.1 must give the notice required by clause 25(1) of Schedule 11.1.
- (3) A **distributor** to whom subclause (1)(b) applies must comply with clause 25(2) of Schedule 11.1.
- (4) The **participants** specified in clauses 25 to 27 of Schedule 11.1 must comply with those clauses.
- (5) If a **network** owner acquires all or part of an existing **network**, the **network** owner must give the notice required by clause 29 of Schedule 11.1.

Compare: Electricity Governance Rules 2003 rule 8 part E

Clause 11.8(1)(a) and (b): amended, on 5 October 2017, by clause 197 of the Electricity Industry Participation Code Amendment (Code Review Programme) 2017.

Clause 11.8(1)(b): amended, on 23 February 2015, by clause 75 of the Electricity Industry Participation Code Amendment (Distributed Generation) 2014.

Clause 11.8(1)(b): amended, on 20 December 2021, by clause 34 of the Electricity Industry Participation Code Amendment (Code Review Programme) 2019.

Clause 11.8(2) and (5): amended, on 1 November 2018, by clause 34 of the Electricity Industry Participation Code Amendment (Code Review Programme) 2018.

11.8A Metering equipment providers to provide registry metering records to registry manager

- (1) A **metering equipment provider** must, for each **metering installation** described in subclause (2) for which it is responsible,—
 - (a) provide to the **registry manager** the **registry metering records** for the **metering installation** in the **prescribed form**; and
 - (b) update the **registry metering records** in accordance with Schedule 11.4.
- (2) Subclause (1) applies to a **metering installation** that is—
 - (a) a **category 1 metering installation**, or higher category of **metering installation**; and
 - (b) for an **ICP** that is not also an **NSP**.

Clause 11.8A Heading: amended, on 5 October 2017, by clause 198(1) of the Electricity Industry Participation Code Amendment (Code Review Programme) 2017.

Clause 11.8A: inserted, on 29 August 2013, by clause 8 of the Electricity Industry Participation (Metering Arrangements) Code Amendment 2011.

Clause 11.8A(1)(a): amended, on 5 October 2017, by clause 198(2) of the Electricity Industry Participation Code Amendment (Code Review Programme) 2017.

11.8B Metering equipment providers to arrange for regular audits

Each **metering equipment provider** must arrange to be **audited** regularly in accordance with Part 16A in respect of the **metering equipment provider's** obligations under this Part.

Clause 11.8B: inserted, on 29 August 2013, by clause 8 of the Electricity Industry Participation (Metering Arrangements) Code Amendment 2011.

Clause 11.8B: replaced, on 1 June 2017, by clause 18 of the Electricity Industry Participation Code Amendment (Requirements and Processes for Audits) 2016.

11.9 *[Revoked]*

Compare: Electricity Governance Rules 2003 rule 8 part E

Clause 11.9: revoked, on 29 August 2013, by clause 9 of the Electricity Industry Participation (Metering Arrangements) Code Amendment 2011.

11.10 Distributors to arrange for regular audits

Each **distributor** must arrange to be **audited** regularly in accordance with Part 16A in respect of the **distributor's** obligations under this Part.

Compare: Electricity Governance Rules 2003 rule 10 part E

Clause 11.10(1)(c): substituted, on 29 August 2013, by clause 5(1) of the Electricity Industry Participation (Metering Arrangements) Code Amendment 2013.

Clause 11.10(1A): inserted, on 29 August 2013, by clause 5(2) of the Electricity Industry Participation (Metering Arrangements) Code Amendment 2013.

Clause 11.10: replaced, on 1 June 2017, by clause 19 of the Electricity Industry Participation Code Amendment (Requirements and Processes for Audits) 2016.

11.11 Authority and participant requested audits

- (1) The **Authority** may at any time carry out, or appoint an **auditor** to carry out, an **audit** of a **participant** in respect of the **participant's** obligations under this Part.
- (2) If a **participant** considers that another **participant** may not have complied with this Part, the **participant** may request that the **Authority** carry out, or appoint an **auditor** to carry out, an **audit** of the other **participant**.
- (3) Part 16A applies to an **audit** carried out under this clause.

Compare: Electricity Governance Rules 2003 rule 10A part E

Clause 11.11: replaced, on 1 June 2017, by clause 20 of the Electricity Industry Participation Code Amendment (Requirements and Processes for Audits) 2016.

11.12 *[Revoked]*

Compare: Electricity Governance Rules 2003 rule 10B part E
Clause 11.12: revoked, on 1 June 2017, by clause 21 of the Electricity Industry Participation Code Amendment (Requirements and Processes for Audits) 2016.

11.13 *[Revoked]*

Compare: Electricity Governance Rules 2003 rule 10C part E
Clause 11.13: revoked, on 1 June 2017, by clause 22 of the Electricity Industry Participation Code Amendment (Requirements and Processes for Audits) 2016.

11.14 Process for maintaining shared unmetered load

- (1) This clause applies if **shared unmetered load** is connected to a **distributor's network**.
- (2) The **distributor** must give written notice to the **registry manager**, and each **trader** responsible under clause 11.18(1) for the **ICPs** across which the **unmetered load** is shared, of the **ICP identifiers** of those **ICPs**.
- (3) A **trader** who receives written notice under subclause (2) must give written notice to the **distributor** if it wishes to add an **ICP** to or omit an **ICP** from the **ICPs** across which the **unmetered load** is shared.
- (3A) A **trader** giving notice under subclause (3) must give a notice to add or omit an **ICP** only to—
 - (a) add an **ICP** if the **consumer** at the **ICP** benefits from the **shared unmetered load**; or
 - (b) omit an **ICP** if the **consumer** at the **ICP** no longer receives benefit from the **shared unmetered load**.
- (4) A **distributor** who receives written notice under subclause (3) must give written notice to the **registry manager** and each **trader** responsible for any of the **ICPs** across which the **unmetered load** is shared of the addition or omission of the **ICP**.
- (5) If a **distributor** becomes aware of a change to the capacity of an **ICP** across which the **unmetered load** is shared or that an **ICP** across which the **unmetered load** is shared is decommissioned, it must give written notice to all **traders** who receive written notice under subclause (2) of the change or decommissioning as soon as practicable after the change or decommissioning.
- (6) A **trader** who receives written notice under subclause (5) must, as soon as practicable after receiving the written notice, adjust the **unmetered load** information for each **ICP** for which it is responsible, so that the **unmetered load** is shared equally across each of those **ICPs**.
- (7) A **trader** must take responsibility for **shared unmetered load** assigned to an **ICP** for which the **trader** becomes responsible as a result of a switch in accordance with this Part.
- (8) A **trader** must not relinquish responsibility for **shared unmetered load** assigned to an **ICP** if there would then be no **ICPs** left across which the load could be shared.
- (9) A **trader** who changes the status of an **ICP** across which the **unmetered load** is shared to inactive in accordance with clause 19 of Schedule 11.1 is not required to give written notice to the **distributor** of the change under subclause (3). The amount of **electricity** attributable to that **ICP** becomes **UFE**.

Compare: Electricity Governance Rules 2003 rule 14 part E
Clause 11.14(1): amended, on 23 February 2015, by clause 75 of the Electricity Industry Participation Code Amendment (Distributed Generation) 2014.
Clause 11.14(1), (2), (3), (4), (5) and (9): amended, on 5 October 2017, by clause 199 of the Electricity Industry Participation Code Amendment (Code Review Programme) 2017.
Clause 11.14(3), (4), (5) and (6): amended, on 1 November 2018, by clause 35 of the Electricity Industry Participation Code Amendment (Code Review Programme) 2018.
Clause 11.14(3A): inserted, on 1 March 2024, by clause 43 of the Electricity Industry Participation Code Amendment (Code Review Programme) 2024.

11.15 Process for customer or embedded generator switching

- (1) This clause applies if a **trader** (“the gaining **trader**”) has an arrangement with a customer or **embedded generator** to—
 - (a) commence trading **electricity** with the customer or **embedded generator** at an **ICP** at which another **trader** (“the losing **trader**”) trades **electricity** with the customer or **embedded generator**; or
 - (b) assume responsibility under clause 11.18(1) for such an **ICP**.
- (2) The gaining **trader** and the losing **trader** must comply with Schedule 11.3.

Compare: Electricity Governance Rules 2003 rule 15 part E
Clause 11.15(1): amended, on 1 November 2018, by clause 36 of the Electricity Industry Participation Code Amendment (Code Review Programme) 2018.

11.15AA Restrictions during switch protected period

A **losing retailer** must not, by any means, including by using a third party or agent acting on its behalf, contact any customer who is switching from the **losing retailer** to a **gaining retailer** to attempt to persuade the customer to terminate the arrangement with the **gaining retailer** during the **switch protected period**, including by –

- (a) making a counter-offer to the customer; or
- (b) offering an enticement to the customer.

Clause 11.15AA: inserted, on 12 January 2015, by clause 4 of the Electricity Industry Participation Code Amendment (Switch Saving Protection) 2014.

Clause 11.15AA(2) and (3): amended, on 5 October 2017, by clause 200 of the Electricity Industry Participation Code Amendment (Code Review Programme) 2017.

Clause 11.15AA: replaced, on 31 March 2020, by clause 7 of the Electricity Industry Participation Code Amendment (Prohibition of Save and Win-Back Approaches by Losing Retailers During a Switch Protected Period) 2020.

11.15AB Retailer may communicate with customers for certain purposes

- (1) Despite clause 11.15AA, a **losing retailer** may contact a customer who is switching to a **gaining retailer** for any or all of the following purposes -
 - (a) to contact the customer to advise the customer of any termination fees that the customer is required to pay as a result of the customer ceasing to trade with the **losing retailer**; or
 - (b) to contact a customer regarding administrative matters, including –
 - (i) any fees the customer owes the **losing retailer**;
 - (ii) the customer’s final meter reading;
 - (iii) how the **losing retailer** will return any keys it holds on the customer’s behalf;
 - (iv) the effect of the customer ceasing to buy **electricity** from the **losing retailer** on other contracts between the customer and the **losing retailer**, for example, for the supply of gas; or

- (c) to provide a factual response to a question asked by a customer; or
 - (d) to make a counter-offer or offer an enticement to a customer where the customer has:
 - (i) contacted the **losing retailer** without the **losing retailer** having first prompted the customer to do so; and
 - (ii) invited the **losing retailer** to attempt to persuade the customer not to complete the **switch** to the **gaining retailer** but to remain with or return to the **losing retailer** instead; or
 - (e) to offer an enticement to a customer as part of a general marketing campaign; or
 - (f) to contact the customer to address network fault issues or to follow up customer complaints.
- (2) If a **losing retailer** contacts a customer under subclause (1), the **losing retailer** must not communicate with the customer for any other purpose other than a purpose specified in subclause (1).
- (3) Without limiting any of its other obligations, a **retailer** (whether a **gaining retailer** or a **losing retailer**) must not harass or coerce a customer.
- Clause 11.15AB: inserted, on 12 January 2015, by clause 4 of the Electricity Industry Participation Code Amendment (Switch Saving Protection) 2014.
- Clause 11.15AB(2), (3) and (4): amended, on 1 November 2018, by clause 37 of the Electricity Industry Participation Code Amendment (Code Review Programme) 2018.
- Clause 11.15AB: replaced, on 31 March 2020, by clause 8 of the Electricity Industry Participation Code Amendment (Prohibition of Save and Win-Back Approaches by Losing Retailers During a Switch Protected Period) 2020.

11.15AC Restrictions on use of customer information by retailer prior to or during switch protected period

- (1) A **losing retailer** must not use information relating to a customer that it obtained prior to or during the **switch protected period**, including information that may be used to contact the customer, during the **switch protected period** to do any of the following:
- (a) contact the customer for any purpose other than a purpose specified in clause 11.15AB;
 - (b) include the customer in a marketing campaign other than a general marketing campaign; or
 - (c) enable any other **retailer**, except the **gaining retailer**, to contact the customer.
- (2) This clause does not limit any other requirement to maintain the confidentiality of any information relating to a customer that is imposed by the contract entered into between the **losing retailer** and the customer or otherwise by law.

Clause 11.15AC: inserted, on 12 January 2015, by clause 4 of the Electricity Industry Participation Code Amendment (Switch Saving Protection) 2014.

Clause 11.15AC: amended, on 1 November 2018, by clause 38 of the Electricity Industry Participation Code Amendment (Code Review Programme) 2018.

Clause 11.15AC: replaced, on 31 March 2020, by clause 9 of the Electricity Industry Participation Code Amendment (Prohibition of Save and Win-Back Approaches by Losing Retailers During a Switch Protected Period) 2020.

11.15AD [Revoked]

Clause 11.15AD: inserted, on 12 January 2015, by clause 4 of the Electricity Industry Participation Code Amendment (Switch Saving Protection) 2014.

Clause 11.15AD: revoked, on 31 March 2020, by clause 10 of the Electricity Industry Participation Code Amendment (Prohibition of Save and Win-Back Approaches by Losing Retailers During a Switch Protected Period) 2020.

11.15A Application of Schedule 11.4

The following parties must comply with Schedule 11.4:

- (a) a **trader** that gives written notice to the **registry manager** of the **gaining metering equipment provider** responsible for each **metering installation** for an **ICP**;
- (b) the **registry manager**;
- (c) the **gaining metering equipment provider**.

Clause 11.15A: inserted, on 29 August 2013, by clause 10 of the Electricity Industry Participation (Metering Arrangements) Code Amendment 2011.

Clause 11.15A(a) and (b): amended, on 5 October 2017, by clause 201 of the Electricity Industry Participation Code Amendment (Code Review Programme) 2017.

11.15B Trader contracts with customers to permit assignment by Authority

- (1) Each **trader** must at all times ensure that the terms of each contract under which a customer of the **trader** purchases **electricity** from the **trader** permit—
 - (a) the **Authority** to assign the rights and obligations of the **trader** under the contract to another **trader** if the **trader** commits an **event of default** under paragraph (a) or (b) or (f) or (h) of clause 14.41(1); and
 - (b) the terms of the assigned contract to be amended on such an assignment to—
 - (i) the standard terms that the recipient **trader** would normally have offered to the customer immediately before the **event of default** occurred; or
 - (ii) such other terms that are more advantageous to the customer than the standard terms, as the recipient **trader** and the **Authority** agree; and
 - (c) the terms of the assigned contract to be amended on such an assignment to include a minimum term in respect of which the customer must pay an amount for cancelling the contract before the expiry of the minimum term; and
 - (d) the **trader** to provide information about the customer to the **Authority** and for the **Authority** to provide the information to another **trader** if required under Schedule 11.5; and
 - (e) the **trader** to assign the rights and obligations of the **trader** to another **trader**.
- (2) The terms specified in subclause (1) must—
 - (a) be expressed to be for the benefit of the **Authority** for the purposes of subpart 1 of Part 2 of the Contract and Commercial Law Act 2017; and
 - (b) not be able to be amended without the consent of the **Authority**.
- (3) *[Revoked]*

Clause 11.15B: inserted, on 16 December 2013, by clause 6 of the Electricity Industry Participation (Managing Retailer Default Situations) Code Amendment 2013.

Heading clause 11.15B: amended, on 28 February 2015, by clause 6(1) of the Electricity Industry Participation Code Amendment (Trader Default) 2014.

Clause 11.15B(1): amended, on 28 February 2015, by clause 6(2)(a) of the Electricity Industry Participation Code Amendment (Trader Default) 2014.

Clause 11.15B(1): amended, on 1 November 2018, by clause 39(1) of the Electricity Industry Participation Code Amendment (Code Review Programme) 2018.

Clause 11.15B(1)(a): amended, on 28 February 2015, by clause 6(2)(b) of the Electricity Industry Participation Code Amendment (Trader Default) 2014.

Clause 11.15B(1)(a): amended, on 1 February 2016, by clause 40 of the Electricity Industry Participation Code Amendment (Code Review Programme) 2015.

Clause 11.15B(1)(a): amended, on 5 October 2017, by clause 202 of the Electricity Industry Participation Code Amendment (Code Review Programme) 2017.

Clause 11.15B(2)(a): amended, on 1 November 2018, by clause 39(2) of the Electricity Industry Participation Code Amendment (Code Review Programme) 2018.

Clause 11.15B(3): revoked, on 28 August 2015, by clause 6(3) of the Electricity Industry Participation Code Amendment (Trader Default) 2014.

11.15C Process for trader events of default

- (1) This clause applies if the **Authority** is satisfied that a **trader** has committed an **event of default** under paragraph (a) or (b) or (f) or (h) of clause 14.41(1).
- (2) The **Authority** and each **participant** must comply with Schedule 11.5.
- (3) This clause ceases to apply, and the **Authority** and each **participant** must cease to comply with Schedule 11.5, if the **Authority** is advised under clause 14.41(2), 14.43(3B), or 14.43(4A) that the relevant **participant** considers that the **event of default** has been remedied.

Clause 11.15C: inserted, on 16 December 2013, by clause 6 of the Electricity Industry Participation (Managing Retailer Default Situations) Code Amendment 2013.

Heading, clause 11.15C: amended, on 28 February 2015, by clause 7(1) of the Electricity Industry Participation Code Amendment (Trader Default) 2014.

Clause 11.15C(1): amended, on 28 February 2015, by clause 7(2) of the Electricity Industry Participation Code Amendment (Trader Default) 2014.

Clause 11.15C(1): amended, on 24 March 2015, by clause 5 of the Electricity Industry Participation Code Amendment (Settlement and Prudential Security) 2014.

Clause 14.15C(1): amended, on 20 December 2021, by clause 35 of the Electricity Industry Participation Code Amendment (Code Review Programme) 2019.

Clause 11.15C(2): amended, on 15 May 2014, by clause 21 of the Electricity Industry Participation (Minor Code Amendments) Code Amendment 2014.

Clause 11.15C(3): inserted, on 1 February 2016, by clause 41 of the Electricity Industry Participation Code Amendment (Code Review Programme) 2015.

11.16 Trader to ensure arrangements for distribution services and metering

Before providing the **registry manager** with information in accordance with clause 11.7(2) or clause 11.18(4), a **trader** must have—

- (a) either,—
 - (i) if the **trader** is a **trader** to whom Schedule 12A.1 or Schedule 12A.3 of Part 12A applies, a **distributor agreement** with the **distributor** on whose **network** the **ICP** is located; or
 - (ii) in all other cases, entered into an arrangement for the provision of **distribution** services in relation to the **ICP** with the **distributor**; and
- (b) entered into an arrangement with a **metering equipment provider** to be responsible for each **metering installation** for the **ICP**.

Compare: Electricity Governance Rules 2003 rule 15 part E

Clause 11.16: substituted, on 29 August 2013, by clause 11 of the Electricity Industry Participation (Metering Arrangements) Code Amendment 2011.

Clause 11.16: amended, on 5 October 2017, by clause 203 of the Electricity Industry Participation Code Amendment (Code Review Programme) 2017.

Clause 11.16: replaced, on 20 July 2020, by clause 6 of the Electricity Industry Participation Code Amendment (Default Distributor Agreement) 2020.

Clause 11.16(a): amended, on 1 February 2016, by clause 42 of the Electricity Industry Participation Code Amendment (Code Review Programme) 2015.

Clause 11.16(a): amended, on 1 November 2018, by clause 40 of the Electricity Industry Participation Code Amendment (Code Review Programme) 2018.

11.17 Connecting ICP that is not also NSP

- (1A) A **distributor** must, when connecting an **ICP** that is not also an **NSP**, follow the connection process set out in clause 10.31.
- (1) A **distributor** must not connect an **ICP** across which **unmetered load** is shared unless a **trader** is recorded in the **registry** as accepting responsibility for the **shared unmetered load**.
- (2) A **distributor** must not connect an **ICP** of any other kind unless a **trader** is recorded in the **registry** as accepting responsibility for the **ICP**.
- (3) Subclause (2) does not apply to an **ICP** that is—
- (a) the **point of connection** between a **network** and an **embedded network**; or
 - (b) the **point of connection of shared unmetered load**.

Compare: Electricity Governance Rules 2003 rule 17 part E

Clause 11.17: heading amended, on 29 August 2013, by clause 12(1) of the Electricity Industry Participation (Metering Arrangements) Code Amendment 2011.

Clause 11.17: heading amended, on 29 August 2013, by clause 5 of the Electricity Industry Participation (Metering Arrangements) Code Amendment 2011, Amendment 2013 (No 2).

Clause 11.17 Heading: amended, on 5 October 2017, by clause 204(1) of the Electricity Industry Participation Code Amendment (Code Review Programme) 2017.

Clause 11.17(1A): inserted, on 29 August 2013, by clause 12 of the Electricity Industry Participation (Metering Arrangements) Code Amendment 2011.

Clause 11.17(1A): substituted, on 29 August 2013, by clause 5 of the Electricity Industry Participation (Metering Arrangements) Code Amendment 2011 Amendment 2013 (No 2).

Clause 11.17(1A), (1) and (2): amended, on 23 February 2015, by clause 75 of the Electricity Industry Participation Code Amendment (Distributed Generation) 2014.

Clause 11.17(1A), (1) and (2): amended, on 5 October 2017, by clause 204(2) and (3) of the Electricity Industry Participation Code Amendment (Code Review Programme) 2017.

11.18 Trader responsibility for ICP

- (1) If a **trader** is recorded in the **registry** as accepting responsibility for an **ICP identifier** that is not also an **NSP**, the **trader** is responsible for all obligations in this Part that—
- (a) apply to **traders**; and
 - (b) relate to an **ICP** that is not also an **NSP**.
- (2) A **trader** ceases to be responsible for obligations in this Part relating to an **ICP** that is not also an **NSP** if—
- (a) another **trader** is recorded in the **registry** as being responsible for the **ICP identifier**; or
 - (b) the **ICP** is **decommissioned** in accordance with clause 20 of Schedule 11.1.
- (3) If an **ICP** is to be **decommissioned**, the **trader** who is responsible for the **ICP identifier** must—
- (a) arrange for a final **interrogation** to take place before or on removal of the **meter**; and
 - (b) advise the **metering equipment provider** responsible for each **metering installation** for the **ICP** that it is to be **decommissioned**.
- (4) A **trader** who is responsible for an **ICP identifier**, other than an **ICP** at which there is only **unmetered load**, must ensure that a **metering equipment provider** is recorded in the **registry** as being responsible for each **metering installation** for the **ICP**.

- (5) The **trader** must not trade at an **ICP** if a **metering equipment provider** is not recorded in the **registry** as being responsible for each **metering installation** for the **ICP**, unless the **trader** trades only **unmetered load** at that **ICP**.

Compare: Electricity Governance Rules 2003 rule 17 part E

Clause 11.18: substituted, on 29 August 2013, by clause 13 of the Electricity Industry Participation (Metering Arrangements) Code Amendment 2011.

Clause 11.18(5): amended, on 15 May 2014, by clause 22 of the Electricity Industry Participation (Minor Code Amendments) Code Amendment 2014.

Clause 11.18(1): amended, on 31 October 2023, by clause 4(1) of the Electricity Industry Participation Code Amendment (Clarification of Trader Obligations) 2023.

Clause 11.18(2): amended, on 31 October 2023, by clause 4(2) of the Electricity Industry Participation Code Amendment (Clarification of Trader Obligations) 2023.

Clause 11.18(3): amended, on 31 October 2023, by clause 4(3) of the Electricity Industry Participation Code Amendment (Clarification of Trader Obligations) 2023.

Clause 11.18(4): amended, on 31 October 2023, by clause 4(4) of the Electricity Industry Participation Code Amendment (Clarification of Trader Obligations) 2023.

11.18A Registry manager to advise metering equipment providers

The **registry manager** must, within 1 **business day** of being advised by a **trader** of a **metering equipment provider's participant identifier** for an **ICP identifier**, —

- (a) if there is not already a **metering equipment provider** assigned to the **ICP identifier**, advise the **gaining metering equipment provider** that the **registry manager** has been advised that it is the **gaining metering equipment provider** for each **metering installation** for the **ICP**; or
- (b) if there is a **losing metering equipment provider**, advise both the **gaining metering equipment provider** and the **losing metering equipment provider** of the advice.

Clause 11.8A Heading: amended, on 5 October 2017, by clause 205(1) of the Electricity Industry Participation Code Amendment (Code Review Programme) 2017.

Clause 11.18A: inserted, on 29 August 2013, by clause 13 of the Electricity Industry Participation (Metering Arrangements) Code Amendment 2011.

Clause 11.18A: amended, on 5 October 2017, by clause 205(2) of the Electricity Industry Participation Code Amendment (Code Review Programme) 2017.

11.18B Metering equipment provider responsibility for metering installation for ICP

- (1) This clause applies to a **metering equipment provider** who assumes responsibility, or is appointed to be responsible, as the **metering equipment provider** for an **ICP**.
- (2) The obligations under this Part, of a **metering equipment provider** to whom this clause applies,—
- (a) commence at the same time as the **metering equipment provider's** obligations under clause 10.21(1);
- (b) terminate when the **metering equipment provider's** obligations under Part 10 terminate under clause 10.23.

- (3) *[Revoked]*

Clause 11.18B: inserted, on 29 August 2013, by clause 13 of the Electricity Industry Participation (Metering Arrangements) Code Amendment 2011.

Clause 11.18B(3): revoked, on 1 November 2018, by clause 41 of the Electricity Industry Participation Code Amendment (Code Review Programme) 2018

11.19 Authority to specify timeframes and formats of information

- (1) Subject to subclause (3), subclause (2) applies if a **participant** is required to provide information under this Part, but this Code does not specify any 1 or more of the following:
 - (a) the time by which, or the period within which, the information must be provided;
 - (b) the format in which the information must be provided;
 - (c) the method by which the information must be provided.
- (2) The **participant** must provide the information in accordance with requirements as to those matters specified by the **Authority**.
- (3) Unless otherwise specified in this Part, information or notices that must be provided under this Part by the **registry manager** or to the **registry manager**, must be provided using the **registry**.

Compare: Electricity Governance Rules 2003 rule 20 part E

Clause 11.19(1): amended, on 5 October 2017, by clause 206(a) of the Electricity Industry Participation Code Amendment (Code Review Programme) 2017.

Clause 11.19(3): inserted, on 5 October 2017, by clause 206(b) of the Electricity Industry Participation Code Amendment (Code Review Programme) 2017.

11.20 Registry must be available between 0730 and 1930 each day

- (1) The **registry manager** must ensure that the **registry** is available to receive and provide information under this Part between 0730 hours and 1930 hours each day.
- (2) Information provided to the **registry manager** after 1930 hours is deemed to be provided at 0730 the next day.

Compare: Electricity Governance Rules 2003 rule 21 part E

Clause 11.20 Heading: amended, on 5 October 2017, by clause 207(1) of the Electricity Industry Participation Code Amendment (Code Review Programme) 2017.

Clause 11.20: amended, on 5 October 2017, by clause 207(2) of the Electricity Industry Participation Code Amendment (Code Review Programme) 2017.

11.21 Confirmation of receipt of data

- (1) Information provided to the **registry manager** is deemed, for the purposes of this Part, not to have been received until the **registry manager** has confirmed receipt in accordance with this clause.
- (2) The **registry manager** must confirm receipt of information received by it in accordance with this Part within 4 hours of the information being provided to it.
- (3) In determining whether the **registry manager** has confirmed receipt within the time specified in subclause (2), no account is to be taken of any period during which the **registry** is not required to be available under clause 11.20.
- (4) If the **participant** providing the information does not receive confirmation that the **registry manager** has received the **participant's** information, the **participant** must contact the **registry manager** to check whether the **registry manager** has received the information.
- (5) If the **registry manager** has not received the information, the **participant** must re-send the information. This process must be repeated until the **registry manager** has confirmed receipt of the information in accordance with this clause.

Compare: Electricity Governance Rules 2003 rules 22.1 and 22.2 part E

Clause 11.21(1), (2), (4) and (5): amended, on 5 October 2017, by clause 208(1) and (3) of the Electricity Industry Participation Code Amendment (Code Review Programme) 2017.

Clause 11.21(3): replaced, on 5 October 2017, by clause 208(2) of the Electricity Industry Participation Code Amendment (Code Review Programme) 2017.

11.22 Registry manager must maintain register of information

- (1) The **registry manager** must maintain a register of information received by it and updated in accordance with this Code.
- (2) The **registry manager** must ensure that a complete audit trail exists for all information received by it in accordance with this Code.

Compare: Electricity Governance Rules 2003 rule 22.3 part E

Clause 11.22 Heading: amended, on 5 October 2017, by clause 209(1) of the Electricity Industry Participation Code Amendment (Code Review Programme) 2017.

Clause 11.22: amended, on 5 October 2017, by clause 209(2) of the Electricity Industry Participation Code Amendment (Code Review Programme) 2017.

Clause 11.22(2): amended, on 1 November 2018, by clause 42 of the Electricity Industry Participation Code Amendment (Code Review Programme) 2018.

11.23 Reports from registry manager

By 1600 hours on the 6th **business day** of each **reconciliation period**, the **registry manager** must **publish** a report containing the following information:

- (a) the number of **ICPs** in the **registry** at the end of the immediately preceding **consumption period**;
- (b) the number of notifications received by the **registry manager** in accordance with clause 2 of Schedule 11.3 during the previous **reconciliation period**;
- (c) such other information as may be agreed from time to time between the **registry manager** and the **Authority**.

Compare: Electricity Governance Rules 2003 rule 23 part E

Clause 11.23 Heading: amended, on 5 October 2017, by clause 210(1) of the Electricity Industry Participation Code Amendment (Code Review Programme) 2017.

Clause 11.23: amended, on 5 October 2017, by clause 210(2) of the Electricity Industry Participation Code Amendment (Code Review Programme) 2017.

Clause 11.23(a): amended, on 1 November 2018, by clause 43 of the Electricity Industry Participation Code Amendment (Code Review Programme) 2018.

11.24 Registry manager delivers reports to specific participants

The **registry manager** must deliver the reports specified in clauses 11.25 to 11.27 in the manner specified in those clauses.

Compare: Electricity Governance Rules 2003 rule 24.1A part E

Clause 11.24 Heading: amended, on 5 October 2017, by clause 211(1) of the Electricity Industry Participation Code Amendment (Code Review Programme) 2017.

Clause 11.24: amended, on 5 October 2017, by clause 211(2) of the Electricity Industry Participation Code Amendment (Code Review Programme) 2017.

11.25 Reports to clearing manager, system operator or reconciliation manager

- (1) The **clearing manager**, or the **system operator**, or the **reconciliation manager** may request in writing, no later than 5 **business days** before the last day of the month before the 1st month for which the report is requested, a report that includes any or all of the following information:

- (a) all active **NSPs** connected to a **local network** during the immediately preceding 14 calendar months:

- (b) all active **NSPs** connected to a **network** for which a **trader** is, and has over the immediately preceding 14 calendar months been, responsible:
 - (c) the dates on which each **trader's** responsibility under this Code at an **NSP** commenced and ceased.
- (2) The **system operator** may at any time request, in writing, a report that sets out every switch made under clauses 2, 9 or 14 of Schedule 11.3, the effect of which is that a **trader** has commenced trading at an **NSP** or a **trader** has ceased trading at an **NSP**.
- (3) A request made under subclauses (1) or (2) may—
- (a) be a one-off request; or
 - (b) specify a frequency over a particular period; or
 - (c) specify a frequency over an indefinite period until terminated by the requesting person.
- (4) If the request is received by the time specified in this clause, the **registry manager** must provide the report by 1000 hours on the 1st **business day** of the month following the month in which the request was made, or if the request for the report specifies a later date, by the later date.
- (5) The person who requested the report may vary any of the details set out in the request, by giving notice to the **registry manager** of the relevant details in writing by no later than 5 **business days** before the last day of the month before the 1st month for which the person requests the variation.
- (6) The **registry manager** must comply with a request made in accordance with subclause (5) by 1000 hours on the 1st **business day** of the month following the month in which the request was made.

Compare: Electricity Governance Rules 2003 rule 24.1 part E

Clause 11.25 Heading: amended, on 5 October 2017, by clause 212(1) of the Electricity Industry Participation Code Amendment (Code Review Programme) 2017.

Clause 11.25(1)(a) and (b): amended, on 23 February 2015, by clause 75 of the Electricity Industry Participation Code Amendment (Distributed Generation) 2014.

Clause 11.25(1), (4), (5) and (6): amended, on 5 October 2017, by clause 212(2) to (4) of the Electricity Industry Participation Code Amendment (Code Review Programme) 2017.

Clause 11.25(5): amended, on 1 November 2018, by clause 44 of the Electricity Industry Participation Code Amendment (Code Review Programme) 2018.

11.26 Reports to reconciliation manager

By 1600 hours on the 4th **business day** of each calendar month, in respect of the immediately preceding **consumption period**, and by 1600 hours on the 13th **business day** of each calendar month in respect of the immediately preceding 14 **consumption periods**, the **registry manager** must deliver the following reports to the **reconciliation manager**:

- (a) a report identifying the number of **ICP days** per **NSP**, differentiated by **half-hour metering** type or non **half-hour metering** type (for the purpose of this clause, **half-hour metering** type on the **registry** must be reported as **half hour**, and all other metering types must be reported as non **half hour**) attributable to each **trader** for those **NSPs** that are recorded on the **registry** as consuming **electricity** at any time during, as the case may be, that **consumption period** or any of those **consumption periods**:

- (b) a report detailing the **loss factor** values for each **loss category** code recorded in the **registry** in respect of all **trading periods**:
- (c) a report detailing the **balancing area** to which each **NSP** belongs recorded in the **registry** in respect of all **trading periods** (including any changes during that month):
- (d) a report detailing the **half hour ICP identifiers** and the **NSPs** to which they are assigned for each individual **trader** (including any changes during that month):
- (e) a report that sets out every switch made under clauses 2, 9 or 14 of Schedule 11.3, the effect of which is that a **trader** has commenced trading at an **NSP** or a **trader** has ceased trading at an **NSP**.

Compare: Electricity Governance Rules 2003 rule 24.2 part E

Clause 11.26 Heading: amended, on 5 October 2017, by clause 213(1) of the Electricity Industry Participation Code Amendment (Code Review Programme) 2017.

Clause 11.26: amended, on 5 October 2017, by clause 213(2) and (3) of the Electricity Industry Participation Code Amendment (Code Review Programme) 2017.

11.27 Reports to Authority

By 1600 hours on the 1st **business day** of each calendar month, the **registry manager** must deliver to the **Authority** a report summarising the number of events—

- (a) that a **participant** has not notified to the **registry manager** within the timeframes specified in this Part; and
- (b) of which the **registry manager** is aware, despite the **participant** not having notified the **registry manager**.

Compare: Electricity Governance Rules 2003 rule 24.3 part E

Clause 11.27 Heading: amended, on 5 October 2017, by clause 214(1) of the Electricity Industry Participation Code Amendment (Code Review Programme) 2017.

Clause 11.27: amended, on 5 October 2017, by clause 214(2) of the Electricity Industry Participation Code Amendment (Code Review Programme) 2017.

Clause 11.27: amended, on 1 November 2018, by clause 45 of the Electricity Industry Participation Code Amendment (Code Review Programme) 2018.

11.28 Access to registry

- (1) A **participant** that requires access to the **registry** must apply to the **Authority** to have access to the **registry**.
- (1A) The **Authority** must specify and **publish** the terms and conditions that apply to **participants** that are granted access to the **registry**.
- (1B) For the avoidance of doubt, the terms and conditions specified and **published** by the **Authority** for access to the **registry** as at 18 April 2019—
 - (a) are the terms and conditions for the purposes of subclause (1A); and
 - (b) apply to a **participant** that has access to the **registry** as at 18 April 2019.
- (2) If the **Authority** grants a **participant's** application,—
 - (a) the **registry manager** must provide the **participant** with access to the **registry** in accordance with the terms and conditions specified and **published** by the **Authority** under subclause (1A):
 - (b) the **participant** must comply with the terms and conditions specified and **published** by the **Authority** under subclause (1A), including any amendments under subclause (2A):

- (c) the **Authority** may restrict or suspend a **participant's** access to the **registry** if the **participant** does not comply with those terms and conditions, even though such a restriction or suspension may affect a **participant's** ability to meet its obligations under this Code.
- (2A) The **Authority** may, from time to time, specify and **publish** amendments to the terms and conditions under which the **Authority** grants access to the **registry**. Such amendments will apply—
- (a) to those **participants** the **Authority** has already granted access to the **registry**; and
- (b) to future applications for access to the **registry**.
- (3) The **Authority** must consult with the **participants** referred to in subclause (2A)(a) on any proposed amendments to the terms and conditions specified and **published** by the **Authority** under subclause (1A).
- (4) If the **Authority** grants a **participant** access to information in the **registry**, and the **participant** requests a report, the **registry manager** must provide the report to the **participant** within 4 hours of receiving the request.
- (5) In determining whether the **registry manager** has provided the report within the time specified in subclause (4), no account is to be taken of any period during which the **registry** is not required to be available under clause 11.20.

Compare: Electricity Governance Rules 2003 rule 25 part E

Clause 11.28(1): replaced, on 18 April 2019, by clause 4(1) of the Electricity Industry Participation Code Amendment (Terms and Conditions for Access to Registry and WITS) 2019.

Clause 11.28(1A) and (1B): inserted, on 18 April 2019, by clause 4(2) of the Electricity Industry Participation Code Amendment (Terms and Conditions for Access to Registry and WITS) 2019.

Clause 11.28(2): replaced, on 18 April 2019, by clause 4(3) of the Electricity Industry Participation Code Amendment (Terms and Conditions for Access to Registry and WITS) 2019.

Clause 11.28(1), (2), (3) and (5): amended, on 5 October 2017, by clause 215(1) to (3) and (5) of the Electricity Industry Participation Code Amendment (Code Review Programme) 2017.

Clause 11.28(2A): inserted, on 29 August 2013, by clause 14(2) of the Electricity Industry Participation (Metering Arrangements) Code Amendment 2011.

Clause 11.28(2A): replaced, on 18 April 2019, by clause 4(4) of the Electricity Industry Participation Code Amendment (Terms and Conditions for Access to Registry and WITS) 2019.

Clause 11.28(3): replaced, on 18 April 2019, by clause 4(5) of the Electricity Industry Participation Code Amendment (Terms and Conditions for Access to Registry and WITS) 2019.

Clause 11.28(4): replaced, on 5 October 2017, by clause 215(4) of the Electricity Industry Participation Code Amendment (Code Review Programme) 2017.

11.29 Registry information change

If a change to **registry** information is provided in accordance with clause 11.7, the **registry manager** must, within 1 **business day** of receiving the information, advise affected **participants** of the change.

Compare: Electricity Governance Rules 2003 rule 26 part E

Clause 11.29: substituted, on 29 August 2013, by clause 15 of the Electricity Industry Participation (Metering Arrangements) Code Amendment 2011.

Clause 11.29: amended, on 5 October 2017, by clause 216 of the Electricity Industry Participation Code Amendment (Code Review Programme) 2017.

11.30 Use of ICP identifier on invoices

Each **trader** must ensure that the relevant **ICP identifier** is printed on every invoice or associated document relating to the sale of **electricity** rendered by the **trader**, and that the **ICP identifier** is clearly labelled "ICP" on the invoice.

Compare: Electricity Governance Rules 2003 rule 27 part E

11.30A Provision of information on dispute resolution scheme

- (1) Each **retailer** and **distributor** must provide information in the circumstances specified in subclauses (2) and (3) about the dispute resolution scheme identified under clause 3 of Schedule 4 of the **Act**.
- (2) The information required by subclause (1) must be clearly and prominently published on any website that—
 - (a) is maintained by, or on behalf of, the **retailer** or **distributor**; and
 - (b) deals with, describes or offers the supply of **electricity** or **line function services** by the **retailer** or **distributor**, or by an agent or related entity of the **retailer** or the **distributor**.
- (3) The information required by subclause (1) must also be clearly and prominently provided—
 - (a) as part of or accompanying any communication personalised for a specific named **consumer** (whether in print, electronic or other medium) from the **retailer** or **distributor**, or by an agent or related entity of the **retailer** or **distributor**, about—
 - (i) billing or charges to, or payments owed by or made by, the **consumer** for the supply of **electricity** or **line function services**, including any invoice, request for payment or statement of account; or
 - (ii) the terms and conditions for the supply of **electricity** or **line function services** to the **consumer**, including the prices, tariffs, energy plan, price plan, tariff plan and terms of service for the **consumer**; and
 - (b) in association with or in the course of the **retailer** or **distributor**, or any person on behalf of the **retailer** or **distributor**, responding in any form, to any query from a **consumer**, including—
 - (i) in association with or in the course of any telephone call from a **consumer**; or
 - (ii) in any emails.
- (4) A **retailer** or **distributor** may meet the requirement in sub-paragraph (3)(b)(i) by providing the information as part of initial automatic answering systems or call holding systems, provided in each case the information is reasonably likely to come to the attention of the **consumer**.

Clause 11.30A: inserted, on 1 April 2021, by clause 4 of the Electricity Industry Participation Code Amendment (Requirements to Improve Awareness of Dispute Resolution Scheme and the Electricity Plan Comparison Site) 2020.
Clause 11.30A(1): amended, on 1 March 2024, by clause 44 of the Electricity Industry Participation Code Amendment (Code Review Programme) 2024.

11.30B Provision of information on electricity plan comparison site

- (1) Each **retailer** that supplies **electricity** at any **ICP** for which the relevant business classification code for the purposes of clause 9(1)(k) of Schedule 11.1 is “000000” or “Residential” must provide clear information in the circumstances specified in subclauses (2) to (4) about the electricity plan comparison website or other platform, as identified on the **Authority’s** website.

- (2) The information required by subclause (1) must be clearly and prominently published on any website that—
 - (a) is maintained by, or on behalf of, the **retailer**; and
 - (b) deals with, describes or offers the supply of **electricity** at any such **ICP** by the **retailer**, or by an agent or related entity of the **retailer**.
- (3) The information required by subclause (1) must also be clearly and prominently provided as part of or accompanying any communication personalised to a specific named **consumer** (whether in print, electronic or other medium) from the **retailer**, or by an agent or related entity of the **retailer**, about—
 - (a) billing or charges to, or payments owed or made by, the **consumer** for the supply of **electricity** at any such **ICP**, including any invoice, request for payment or statement of account; or
 - (b) the terms and conditions for the supply of **electricity** at any such **ICP**, including the prices, tariffs, energy plan, price plan, tariff plan and terms of service for the **consumer**.
- (4) The information required by subclause (1) must also be clearly and prominently provided at least once every calendar year to each customer the **retailer** supplies **electricity** to at an **ICP** referred to in subclause (1).
- (5) If the **Authority** changes the web address of the electricity plan comparison website, establishes a new platform to perform the same purpose, or changes that platform or its location descriptor, each **retailer** must change the information published or provided under clause 11.30A to refer to the new address, platform or location descriptor as soon as reasonably possible and no later than 3 months from the date the change is notified on the **Authority's** website.

Clause 11.30B: inserted, on 1 April 2021, by clause 4 of the Electricity Industry Participation Code Amendment (Requirements to Improve Awareness of Dispute Resolution Scheme and the Electricity Plan Comparison Site) 2020.
Clause 11.30B(4): amended, on 1 March 2024, by clause 45 of the Electricity Industry Participation Code Amendment (Code Review Programme) 2024.

11.30C Specific requirements for information provided on websites and by other electronic means

The information provided under clauses 11.30A(2) and 11.30B(2)—

- (a) must be prominently provided on, or linked to, a page or pages of the **retailer's** or **distributor's** website, which a **consumer** seeking information on or in relation to the supply of **electricity** or **line function services**, or on the complaint processes of the **retailer** or **distributor**, is reasonably likely to view; but
- (b) does not need to be provided on every such page or every part, provided a **consumer** seeking such information is reasonably likely to come across the information in the course of visiting the website.

Clause 11.30C: inserted, on 1 April 2021, by clause 4 of the Electricity Industry Participation Code Amendment (Requirements to Improve Awareness of Dispute Resolution Scheme and the Electricity Plan Comparison Site) 2020.

11.30D Limitations on required information disclosure under clause 11.30A and 11.30B

- (1) If a **retailer** or a **distributor** has provided the information required by clause 11.30A or 11.30B to a **consumer**—

- (a) in a **consumer** communication under clause 11.30A(3)(a) or 11.30B(3), the **retailer** or **distributor** does not need to continue to provide the information in any subsequent **consumer** communication on the same matter; or
 - (b) in response to any query under clause 11.30A(3)(b), the **retailer** or **distributor** does not need to continue to provide the information in any further responses to the same or related queries.
- (2) Under subclause (1):
- (a) an invoice and any request for payment, reminder notice, notice of late payment, demand, or disconnection notice in respect of the amount in the invoice are on the same matter; but
 - (b) invoices that apply to different periods are not on the same matter.

Clause 11.30D: inserted, on 1 April 2021, by clause 4 of the Electricity Industry Participation Code Amendment (Requirements to Improve Awareness of Dispute Resolution Scheme and the Electricity Plan Comparison Site) 2020.

11.30E Meaning of “related entity”

For the purposes of clause 11.30A and 11.30B, the term “related entity” has the meaning set out in section 2(3) of the Companies Act 1993, where the reference in that section to “company” is read as if it referred to either a “company” or a “body corporate”.

Clause 11.30E: inserted, on 1 April 2021, by clause 4 of the Electricity Industry Participation Code Amendment (Requirements to Improve Awareness of Dispute Resolution Scheme and the Electricity Plan Comparison Site) 2020.

11.31 Customer and embedded generator queries

- (1) If a **trader** receives a request from a customer of the **trader** or a person authorised by a customer of the **trader** for the customer’s **ICP identifier**, the **trader** must provide that information no later than 3 **business days** after receiving the request.
- (2) If a **distributor** receives a request from a customer or **embedded generator** whose **ICP** is connected to the **distributor’s network** for the customer’s or **embedded generator’s ICP identifier**, or a person authorised by such a customer or **embedded generator**, the **distributor** must provide that information no later than 3 **business days** after receiving the request.

Compare: Electricity Governance Rules 2003 rule 28 part E

Clause 11.31(1): amended, on 1 November 2018, by clause 46(1) of the Electricity Industry Participation Code Amendment (Code Review Programme) 2018.

Clause 11.31(2): amended, on 23 February 2015, by clause 75 of the Electricity Industry Participation Code Amendment (Distributed Generation) 2014.

Clause 11.31(2): amended, on 5 October 2017, by clause 217 of the Electricity Industry Participation Code Amendment (Code Review Programme) 2017.

Clause 11.31(2): amended, on 1 November 2018, by clause 46(2) of the Electricity Industry Participation Code Amendment (Code Review Programme) 2018.

11.32 Reliance on registry

A **participant** does not breach this Code just because the **participant** does something relying on an incorrect record in the **registry**.

Compare: Electricity Governance Rules 2003 rule 29 part E

Access by consumers to information about their own electricity consumption

Cross Heading: inserted, on 1 February 2016, by clause 5 of the Electricity Industry Participation Code Amendment (Access to Retail Data) 2014.

11.32A Retailers must give information about consumer electricity consumption

- (1) Each **retailer** must, if requested by a **consumer** with whom the **retailer** has a contract to supply **electricity**, or with whom the **retailer** has had such a contract in the last 24 months, give the **consumer** any of the information specified in subclause (2) that the **consumer** requests.
- (2) The information referred to in subclause (1) is information relating to any period in the 24 months preceding the request—
 - (a) about the **consumer's** consumption of **electricity** relating to each **ICP** at which the **retailer** supplied **electricity** to the **consumer**; and
 - (b) used by the **retailer** to—
 - (i) calculate the amount of **electricity** consumed by the **consumer** at each **ICP**; or
 - (ii) provide any service to the **consumer**.

Clause 11.32A: inserted, on 1 February 2016, by clause 5 of the Electricity Industry Participation Code Amendment (Access to Retail Data) 2014.

11.32B Requests for information

- (1) A **retailer** to which a request is made must give the information to the **consumer** no later than 5 **business days** after the date on which the request is made.
- (2) In responding to a request, the **retailer** must comply with the procedures, and any relevant **EIEP**, **published** by the **Authority** under clause 11.32F.
- (3) A **retailer** must not charge a fee for responding to a request, but if 4 requests in respect of a **consumer's** information have been made in a 12 month period, the **retailer** may impose a reasonable charge for further requests in that 12 month period.

Clause 11.32B: inserted, on 1 February 2016, by clause 5 of the Electricity Industry Participation Code Amendment (Access to Retail Data) 2014.

Clause 11.32B(2): amended, on 1 February 2016, by clause 43 of the Electricity Industry Participation Code Amendment (Code Review Programme) 2015.

Clause 11.32B(2): amended, on 5 October 2017, by clause 218 of the Electricity Industry Participation Code Amendment (Code Review Programme) 2017.

11.32C Retailers must give written notice to consumers of availability of information

Each **retailer** must give written notice to each **consumer** with whom it has a contract to supply **electricity** of the **consumer's** ability to make a request to the **retailer** under clause 11.32B, so that the **consumer** is given written notice at least once in each year.

Clause 11.32C Heading: amended, on 5 October 2017, by clause 219(1) of the Electricity Industry Participation Code Amendment (Code Review Programme) 2017.

Clause 11.32C: inserted, on 1 February 2016, by clause 5 of the Electricity Industry Participation Code Amendment (Access to Retail Data) 2014.

Clause 11.32C: amended, on 5 October 2017, by clause 219(2) of the Electricity Industry Participation Code Amendment (Code Review Programme) 2017.

11.32D Information security

A **retailer** that receives a request for information under clause 11.32B—

- (a) must not give access to that information unless it is satisfied as to the identity of the **consumer** making the request; and
- (b) must ensure, by the adoption of appropriate procedures, that any information intended for a **consumer** is received—
 - (i) only by the **consumer**; or
 - (ii) where the request is made by an agent of the **consumer**, only by the **consumer** or the **consumer's** agent.

Clause 11.32D: inserted, on 1 February 2016, by clause 5 of the Electricity Industry Participation Code Amendment (Access to Retail Data) 2014.

11.32E Agents

If a **consumer** authorises an agent to request information under clause 11.32B on behalf of the **consumer**, a **retailer** must deal with any request from the agent for information about the **consumer** under clause 11.32B in accordance with:

- (a) clauses 11.32A and 11.32EB;
- (b) clause 11.32ED, if a request:
 - (i) includes a statement from the agent that the agent has obtained, or the request is accompanied by, a written authority from the **consumer** in the form and containing the information required by Schedule 11.6; and
 - (ii) the request is made through the **EIE System**; and
- (c) the Privacy Act 2020, where applicable.

Clause 11.32E: inserted, on 1 February 2016, by clause 5 of the Electricity Industry Participation Code Amendment (Access to Retail Data) 2014.

Clause 11.32E: amended, on 1 March 2020, by clause 5(a) and (b) of the Electricity Industry Participation Code Amendment (Requirements and Processes for Information Requests by Agents) 2020.

Clause 11.32E(c): amended, on 1 March 2024, by clause 46 of the Electricity Industry Participation Code Amendment (Code Review Programme) 2024.

11.32EA Retailer actions on receipt of requests from agents

- (1) A **retailer**, after receiving a request under clause 11.32B from an agent on behalf of a **consumer**, must:
 - (a) make a decision on the request, and advise the agent of that decision, as soon as reasonably practicable; and
 - (b) provide the information requested within the timeframe required by clause 11.32B unless there are grounds for refusing the request under clause 11.32EB.
- (2) If the **retailer** considers, in accordance with subclause (1), that there are grounds for refusing the request, the **retailer** must, before refusing the request:
 - (a) consider whether any further information could reasonably be provided by the agent to satisfy the **retailer**; and
 - (b) request any such further information from the agent, specifying the further information required in detail.
- (3) If further information is provided under subclause (2)(b), the **retailer** upon receiving the further information must:

- (a) make a final decision on the request, and advise the agent of that decision, as soon as reasonably practicable; and
 - (b) provide the information requested within the timeframe required by clause 11.32B as calculated from the time the **retailer** receives the further information, unless there are grounds for refusing the request under clause 11.32EB.
- (4) If a **retailer** decides to refuse a request, in advising the agent of that decision, the **retailer** must:
- (a) indicate the ground or grounds under clause 11.32EB(1) that the **retailer** is relying on to refuse the request; and
 - (b) provide the agent with the detailed reasons as to why that ground or grounds applies or apply.
- (5) If a **retailer** decides to grant a request in full, the **retailer** meets the obligation to advise the agent of that decision by providing the information to the agent in accordance with subclauses (1)(b) and (3)(b).
- (6) The obligations in subclauses (1)(a) and (3)(a) do not detract from the obligations in subclauses (1)(b) and (3)(b), respectively.
- Clause 11.32EA: inserted, on 1 March 2020, by clause 6 of the Electricity Industry Participation Code Amendment (Requirements and Processes for Information Requests by Agents) 2020.

11.32EB Decisions on requests

- (1) A **retailer** that receives a request under clause 11.32B from an agent on behalf of a **consumer** must grant the request and provide the information unless the **retailer** believes on reasonable grounds:
- (a) that the **consumer** has not authorised the request;
 - (b) that complying with the request would otherwise cause the **retailer** to breach its obligations under the Privacy Act 2020 (where it applies); or
 - (c) that:
 - (i) if the request is accompanied by a written authority in the form and containing the information required by Schedule 11.6 or the agent subsequently provides a copy of such an authority, any of the information required by Schedule 11.6 is incorrect in a material way, such that the **retailer** cannot be satisfied of the matters in paragraphs (a) or (b) or is unable to identify the **consumer** the request relates to; or
 - (ii) in any other situation, the **retailer** is unable to identify the **consumer** the request relates to.
- (2) A **retailer** may not refuse a request under clause 11.32B from an agent on behalf of a **consumer** on the basis that the request or any authorisation relating to the request is not in a particular form, or does not follow a particular process.
- Clause 11.32EB: inserted, on 1 March 2020, by clause 6 of the Electricity Industry Participation Code Amendment (Requirements and Processes for Information Requests by Agents) 2020.
Clause 11.32EB(1)(b): amended, on 1 March 2024, by clause 47 of the Electricity Industry Participation Code Amendment (Code Review Programme) 2024.

11.32EC Requirements for agents who are participants

- (1) This clause applies to each **participant** who wishes to make or who makes a request for information to a **retailer** under clause 11.32B as an agent on behalf of a **consumer**.

- (2) Before making the request, the **participant** must obtain an authorisation from the **consumer** for the **participant** to request the transfer of the information to the agent on behalf of the **consumer**.
- (3) The **participant** must:
 - (a) retain a copy of the authorisation under subclause (2) or otherwise retain evidence that the **consumer** has provided the authorisation required by subclause (2); and
 - (b) provide a copy of the authorisation or other evidence to the **retailer**, if requested by the **retailer**.

Clause 11.32EC: inserted, on 1 March 2020, by clause 6 of the Electricity Industry Participation Code Amendment (Requirements and Processes for Information Requests by Agents) 2020.

11.32ED Additional requirements on retailers for authorisations in prescribed form and requests received through the EIE System

- (1) This clause applies where an agent requests information from a **retailer** on behalf of a **consumer** under clause 11.32B and:
 - (a) subject to clause 11.32EE, either:
 - (i) the request includes a statement from the agent that the agent has obtained a written authority from the **consumer** in the form and containing the information required by Schedule 11.6 (being an authority that remains in force at the date the request is made); or
 - (ii) the agent separately provides a written authority in the form and containing the information required by Schedule 11.6 or a copy of such a written authority (being an authority that remains in force at the date the request is made); and
 - (b) the request is made through the **EIE System**.
- (2) If this clause applies:
 - (a) the **retailer** must use all reasonable endeavours to take the steps in clauses 11.32EA(1)(a) and 11.32EA(2), as applicable, within 2 **business days** of the later of:
 - (i) receiving the request; or
 - (ii) receiving a copy of a written authority under subparagraph (1)(a)(ii); and
 - (b) where clause 11.32EA(3) applies, the **retailer** must use all reasonable endeavours, within 2 **business days** of receiving further information from the agent, to take the steps in clause 11.32EA(3)(a).
- (3) Where clause 11.32EA(2) applies, the request may include a request that the agent provide a copy of the written authority referred to in subclause (1)(a), if not provided with the request.
- (4) If a request is made through the **EIE System**, but the **retailer** believes on reasonable grounds that the request does not meet the requirements of the **EIEP**, subclauses (2) and (3) do not apply but, for the avoidance of doubt, the **retailer** must still comply with clauses 11.32B, 11.32EB and 11.32EC.

Clause 11.32ED: inserted, on 1 March 2020, by clause 6 of the Electricity Industry Participation Code Amendment (Requirements and Processes for Information Requests by Agents) 2020.

11.32EE Requirements for written authorities under Schedule 11.6

- (1) Each written authority, for the purposes of clause 11.32ED, must include or be accompanied by:
 - (a) if the **consumer** is an individual (being a natural person), an **electronic signature** or physical signature of the **consumer** or of a person on behalf of the **consumer** (in which case, evidence of that person's authority to sign on behalf of the **consumer** is required) or other evidence that the **consumer** has approved the authority; or
 - (b) if the **consumer** is not an individual (not being a natural person), an **electronic signature** or physical signature of an authorised representative of the **consumer** or other evidence that the **consumer** has approved the authority.
- (2) Each **electronic signature**, for the purposes of subclause (1), must meet the requirements of sections 226 and 228 of the Contract and Commercial Law Act 2017.
Clause 11.32EE: inserted, on 1 March 2020, by clause 6 of the Electricity Industry Participation Code Amendment (Requirements and Processes for Information Requests by Agents) 2020.

11.32EF Revocation of authority

- (1) If a **retailer** receives notification from a **consumer** that the **consumer** has revoked an authority, the **retailer** must notify the agent within 2 **business days** of receiving the notification that the authority is revoked.
- (2) If an agent that is a **participant** receives notification from a **consumer** that the **consumer** has revoked the agent's authority, the agent must notify the **retailer** within 2 **business days** of receiving the notification that the authority is revoked.
Clause 11.32EF: inserted, on 1 March 2020, by clause 6 of the Electricity Industry Participation Code Amendment (Requirements and Processes for Information Requests by Agents) 2020.

11.32EG Authority may prescribe EIE System

- (1) The **Authority** may prescribe a system for the purpose of clauses 11.32E to 11.32ED for the:
 - (a) exchange of information between **participants**;
 - (b) the provision of information by **participants** to other **participants** or other persons; and
 - (c) the making of requests for information by **participants** or other persons to **participants**.
- (2) The **Authority** must advise **participants** and other parties of any system it prescribes under subclause (1) by posting a notice of the prescribed system on the **Authority's** website.
Clause 11.32EG: inserted, on 1 March 2020, by clause 6 of the Electricity Industry Participation Code Amendment (Requirements and Processes for Information Requests by Agents) 2020.

11.32F Authority to publish procedures for responding to requests for consumption information

- (1) The **Authority** must—
 - (a) **publish**, and keep **published**, procedures under which a **retailer** must respond to a request from a **consumer** under clause 11.32B; and
 - (b) prescribe 1 or more **EIEPs** with which a **retailer** must comply when responding to such a request.

- (1A) The **Authority** must **publish** an **EIEP** it prescribes under subclause (1).
- (2) The procedures **published** by the **Authority** must specify the manner in which information must be given to **consumers**.
- (3) Each **EIEP** prescribed by the **Authority** must specify 1 or more formats in which information must be given to **consumers**.
- (4) Before the **Authority** prescribes an **EIEP** under subclause (1), or amends an **EIEP** that it has prescribed under subclause (1), it must consult with the **participants** that the **Authority** considers are likely to be affected by the **EIEP**.
- (5) The **Authority** need not comply with subclause (4) if it proposes to amend an **EIEP** prescribed under subclause (1) if the **Authority** is satisfied that—
 - (a) the nature of the amendment is technical and non-controversial; or
 - (b) there has been adequate prior consultation so that the **Authority** has considered all relevant views.

Clause 11.32F Heading: amended, on 5 October 2017, by clause 220(1) of the Electricity Industry Participation Code Amendment (Code Review Programme) 2017.

Clause 11.32F: inserted, on 1 February 2016, by clause 5 of the Electricity Industry Participation Code Amendment (Access to Retail Data) 2014.

Clause 11.32F: substituted, on 1 February 2016, by clause 44 of the Electricity Industry Participation Code Amendment (Code Review Programme) 2015.

Clause 11.32F(1): replaced, on 5 October 2017, by clause 220(2) of the Electricity Industry Participation Code Amendment (Code Review Programme) 2017.

Clause 11.32F(1A): inserted, on 5 October 2017, by clause 220(2) of the Electricity Industry Participation Code Amendment (Code Review Programme) 2017.

Clause 11.32F(2) to (5): amended, on 5 October 2017, by clause 220(3) of the Electricity Industry Participation Code Amendment (Code Review Programme) 2017.

11.32G Retailers must provide information about generally available retail tariff plans

- (1) If any person asks a **retailer** to provide information about 1 or more of the **retailer's** current **generally available retail tariff plans**, the **retailer** must give the requested information to the person no later than **5 business days** after receiving the request.
- (2) If the person requests that information be provided under subclause (1) in a manner or format that differs from the manner or format the **retailer** typically uses to provide such information, the **retailer** may impose a reasonable charge for providing the information in the manner or form requested.

Clause 11.32G: inserted, on 1 February 2016, by clause 6 of the Electricity Industry Participation Code Amendment (Access to Retail Tariff Information) 2015.

11.33 Authority may direct registry to be suspended *[Expired]*

Clause 11.33: inserted, from 24 May 2013 to 29 December 2013, by clause 4 of the Electricity Industry Participation (Transitional Provisions for New Metering Arrangements) Code Amendment 2013.

11.34 Registry manager, distributors, and traders not required to comply with obligations when registry suspended *[Expired]*

Clause 11.34: inserted, from 24 May 2013 to 29 December 2013, by clause 4 of the Electricity Industry Participation (Transitional Provisions for New Metering Arrangements) Code Amendment 2013.

11.35 Registry manager and traders not required to comply with specified provisions after registry resumes operation *[Expired]*

Clause 11.35: inserted, from 24 May 2013 to 29 December 2013, by clause 4 of the Electricity Industry Participation (Transitional Provisions for New Metering Arrangements) Code Amendment 2013.

11.36 Clauses to expire *[Expired]*

Clause 11.36: inserted, from 24 May 2013 to 29 December 2013, by clause 4 of the Electricity Industry Participation (Transitional Provisions for New Metering Arrangements) Code Amendment 2013.

cl 11.7

Schedule 11.1
Creation and management of ICPs, ICP identifiers and NSPs

ICPs and ICP identifiers

1 ICP identifiers

- (1) A **distributor** must create an **ICP identifier** for each **ICP** on each **network** for which the **distributor** is responsible in accordance with the following format:

yyyyyyyyyyxxccc

where

yyyyyyyyyy is a numerical sequence provided by the **distributor**

xx is a code assigned by the **Authority** to the issuing **distributor** that ensures the **ICP** is unique

ccc is a checksum generated according to the algorithm provided by the **Authority**.

- (2) The **ICP identifier** must be used by a **participant** in all communications with the **registry manager** to identify—
- (a) the point at which a **trader** is deemed to convey **electricity** to a **consumer** or from an **embedded generating station**; and
 - (b) the **point of connection** between an **embedded network** and its parent **network**, or the **point of connection** between a **shared unmetered load** and its **network**.
- (3) Despite any clause to the contrary, only the obligations in this clause and clauses 2, 6 and 7(1)(a) to (e), (l) and (m) apply if an **ICP identifier** is used to **identify** a—
- (a) **point of connection** between an **embedded network** and its parent **network**; or
 - (b) **point of connection** between **shared unmetered load** and its **network**.
- (4) If an **ICP identifier** is used in the management of the status of the **ICP**, the obligations in clauses 13, 16 and 20 also apply.

Compare: Electricity Governance Rules 2003 clause 1.1 schedule E1
Clause 1(1) and (2): amended, on 5 October 2017, by clause 221 of the Electricity Industry Participation Code Amendment (Code Review Programme) 2017.

2 Address

- (1) Each **ICP identifier** must have a location address that allows the **ICP** to be readily located.
- (2) Despite subclause (1), the address of an **ICP identifier** for **distributed unmetered load** may be the location of the **distributed unmetered load** database.

Compare: Electricity Governance Rules 2003 clause 1.2 schedule E1

Clause 2(2): inserted, on 29 August 2013, by clause 6 of the Electricity Industry Participation (Metering Arrangements) Code Amendment 2013.

3 Electrically disconnecting

- (1) Subject to subclause (2), a **distributor** must not create an **ICP identifier** or connect an **ICP** created after 7 October 2002 unless—
 - (a) the **ICP identifier** is for an **ICP** that can be **electrically disconnected** without **electrically disconnecting** another **ICP**; and
 - (b) the **ICP** can be **electrically disconnected** without **electrically disconnecting** another **ICP**.
- (2) Subclause (1) does not apply if the **ICP** is—
 - (a) the **point of connection** between a **network** and an **embedded network**; or
 - (b) an **ICP** that represents the consumption calculated by the difference between the total consumption for the **embedded network** and all other **ICPs** on the **embedded network**.
- (3) A **distributor** must not—
 - (a) connect a new **ICP** to an existing **ICP** in series unless the existing **ICP** is of the type described in subclause (2)(a) or (2)(b); or
 - (b) create a new **ICP identifier** for a new or existing **ICP** in series with an existing **ICP** unless the existing **ICP** is of the type described in subclause (2)(a) or (2)(b) and the **distributor** is responsible for both the new and existing **ICPs**.

Compare: Electricity Governance Rules 2003 clause 1.3 schedule E1

Clause 3 Heading: replaced, on 5 October 2017, by clause 222(1) of the Electricity Industry Participation Code Amendment (Code Review Programme) 2017.

Clause 3: amended, on 5 October 2017, by clause 222(2) of the Electricity Industry Participation Code Amendment (Code Review Programme) 2017.

Clause 3: replaced, on 1 March 2024 by clause 48 of the Electricity Industry Participation Code Amendment (Code Review Programme) 2024.

4 Authority may grant dispensation

The **Authority** may, by giving written notice, grant a dispensation from the requirements of clause 3 for an **ICP** that cannot be **electrically disconnected** without **electrically disconnecting** another **ICP**.

Compare: Electricity Governance Rules 2003 clause 1.4 schedule E1

Clause 4: amended, on 5 October 2017, by clause 223 of the Electricity Industry Participation Code Amendment (Code Review Programme) 2017.

Clause 4: amended, on 1 November 2018, by clause 47 of the Electricity Industry Participation Code Amendment (Code Review Programme) 2018.

5 Electrical load

The electrical load associated with an **ICP** is deemed to be supplied through 1 **network supply point** only.

Compare: Electricity Governance Rules 2003 clause 1.5 schedule E1

6 Loss category

An **ICP** must have a single **loss category** code that is referenced in such a way as to identify the associated **loss factors**.

Compare: Electricity Governance Rules 2003 clause 1.6 schedule E1

Provision of ICP information to the registry manager

Cross heading: amended, on 5 October 2017, by clause 224 of the Electricity Industry Participation Code Amendment (Code Review Programme) 2017.

7 Distributors to provide ICP information to registry manager

- (1) A **distributor** must, for each **ICP** on the **distributor's network**, provide the following information to the **registry manager**:
- (a) the location address of the **ICP identifier**:
 - (b) subject to subclause (4), the **NSP identifier** of the **NSP** to which the **ICP** is usually connected:
 - (c) the **installation type** code assigned to the **ICP**:
 - (d) the **reconciliation type** code assigned to the **ICP**:
 - (e) the **loss category** code and **loss factors** for each **loss category** code assigned to the **ICP**:
 - (f) if the **ICP** connects the **distributor's network** to an **embedded generating station** that has a capacity of 10 **MW** or more, the information required by subclause (6), in accordance with subclause (7):
 - (g) the **price category** code assigned to the **ICP**, which may be a placeholder **price category** code only if the **distributor** is unable to assign the actual **price category** code because the capacity or **volume information** required to assign the actual **price category** code cannot be determined before **electricity** is traded at the **ICP**:
 - (h) if the **price category** code assigned under paragraph (g) requires one or more values for the capacity of the **ICP**, the **chargeable capacity** of the **ICP**, as follows:
 - (i) if the **chargeable capacity** cannot be determined before **electricity** is traded at the **ICP**, a placeholder **chargeable capacity**:
 - (ii) if the capacity value or values can be determined for a **billing period** from the **metering information** collected for that **billing period**, no **chargeable capacity**:
 - (iia) if there is more than one capacity value at the **ICP**, and one or more, but not all, of those capacity values can be determined for a **billing period** from the **metering information** collected for that **billing period**—
 - (A) no capacity value recorded in the **registry** field for the **chargeable capacity**; and
 - (B) either the term "POA" or all other capacity values, recorded in the **registry** field in which the **distributor** installation details are also recorded:
 - (iib) if there is more than one capacity value at the **ICP**, and none of those capacity values can be determined for a **billing period** from the **metering information** collected for that **billing period**—
 - (A) the annual capacity value recorded in the **registry** field for the **chargeable capacity**; and
 - (B) either the term "POA" or all other capacity values, recorded in the **registry** field in which the **distributor** installation details are also recorded:
 - (iii) in any other case, the actual **chargeable capacity**:

- (i) the **distributor** installation details of the **ICP** determined by the **price category** code assigned to the **ICP** (if any), which may be placeholder **distributor** installation details only if the **distributor** is unable to assign the actual **distributor** installation details because the capacity or **volume information** required to assign the actual **distributor** installation details cannot be determined before **electricity** is traded at the **ICP**;
 - (j) the **participant identifier** of the first **trader** who has entered into an arrangement with a customer or an **embedded generator** to sell or purchase **electricity** at the **ICP** (only if the information is provided by the first **trader**);
 - (k) the status of the **ICP** determined in accordance with clauses 12 to 20;
 - (l) designation of the **ICP** as "Dedicated" if the **ICP** is located in a **balancing area** that has more than 1 **NSP** located within it, and—
 - (i) the **ICP** will be supplied only from the **NSP** with the **NSP identifier** provided under paragraph (b); or
 - (ii) the **ICP** is a **point of connection** between a **network** and an **embedded network**;
 - (m) if **unmetered load**, other than **distributed unmetered load**, is associated with the **ICP**, the type and capacity in kW of the **unmetered load** (if the **distributor** knows that information);
 - (n) if **shared unmetered load** is associated with the **ICP**, a list of the **ICP identifiers** of the **ICPs** that are associated with the **unmetered load**;
 - (o) if the **ICP** connects the **distributor's network** to **distributed generation**,—
 - (i) the **nameplate capacity** of the **distributed generation**; and
 - (ii) the generation fuel type of the **distributed generation**;
 - (p) the date on which the **ICP** is initially **electrically connected**.
- (1A) For the purposes of subclause (1)(h), if the **price category** assigned to the **ICP** requires information additional to **chargeable capacity** to unambiguously define the line charges, the additional information may be contained in the **distributor** installation details field of the **registry**.
- (2) The **distributor** must provide the information specified in subclauses (1)(a) to (1)(o) to the **registry manager** as soon as practicable after the **ICP identifier** for the **ICP** to which the information relates is created, and before **electricity** is traded at the **ICP**.
- (2A) The **distributor** must provide the information specified in subclause (1)(p) to the **registry manager** no later than 10 **business days** after the date on which the **ICP** is initially **electrically connected**.
- (2B) Despite subclause (2A), the **distributor** is not required to provide the information specified in subclause (1)(p) if the date on which the **ICP** is initially **electrically connected** is earlier than 29 August 2013.
- (3) The **distributor** must provide the following information to the **registry manager** no later than 10 **business days** after the trading of **electricity** at the **ICP** commences:
- (a) the actual **price category** code assigned to the **ICP**;
 - (b) the actual **chargeable capacity** of the **ICP** determined by the **price category** code assigned to the **ICP** (if any):

- (c) the actual **distributor** installation details of the **ICP** determined by the **price category** code assigned to the **ICP** (if any).
- (4) If a **distributor** cannot identify the **NSP** that is connected to an **ICP**, the **distributor** must nominate the **NSP** that the **distributor** thinks is most likely to be connected to the **ICP**, taking into account the flow of **electricity** within the **distributor's network**.
- (5) An **ICP** is deemed to be connected to the **NSP** nominated by the **distributor** under subclause (1)(b).
- (6) If a **distributor** assigns a **loss category** code to an **ICP** on the **distributor's network** that connects the **distributor's network** to an **embedded generating station** that has a capacity of 10MW or more—
- (a) the **loss category** code assigned to the **ICP** must be unique and must not be assigned to any other **ICP** on the **distributor's network**; and
- (b) the **distributor** must provide the following information to the **reconciliation manager**:
- (i) the unique **loss category** code assigned to the **ICP**;
- (ii) the **ICP identifier** of the **ICP**;
- (iii) the **NSP identifier** of the **NSP** to which the **ICP** is connected;
- (iv) the plant name of the **embedded generating station**.
- (7) The **distributor** must provide the information in subclause (6) no later than 5 **business days** before the **distributor** assigns the **loss category** code.
- (8) A **distributor** may provide the **registry manager** with global positioning system coordinates for each **ICP** on the **distributor's network**.
- (9) If a **distributor** provides the global positioning system coordinates of an **ICP** to the **registry manager** under subclause (8), it must provide the coordinates—
- (a) as New Zealand Transverse Mercator 2000 (NZTM2000) coordinates as defined in Land Information New Zealand's LINZS25002 standard (Standard for New Zealand Geodetic Datum 2000 Projections); or
- (b) in a format specified by the **Authority**.

Compare: Electricity Governance Rules 2003 clause 2 schedule E1

Clause 7(1) Heading: amended, on 5 October 2017, by clause 225(1) of the Electricity Industry Participation Code Amendment (Code Review Programme) 2017.

Clause 7(1): amended, on 15 May 2014, by clause 23 of the Electricity Industry Participation (Minor Code Amendments) Code Amendment 2014.

Clause 7(1), (2), (2A), (3), (8) and (9): amended, on 5 October 2017, by clause 225(2) of the Electricity Industry Participation Code Amendment (Code Review Programme) 2017.

Clause 7(1)(a): amended, on 29 August 2013, by clause 16 of the Electricity Industry Participation (Metering Arrangements) Code Amendment 2011.

Clause 7(1)(b): amended, on 23 February 2015, by clause 75 of the Electricity Industry Participation Code Amendment (Distributed Generation) 2014.

Clause 7(1)(b), (4), (5) and (6)(b)(iii): amended, on 5 October 2017, by clause 225(3) of the Electricity Industry Participation Code Amendment (Code Review Programme) 2017.

Clause 7(1)(h): substituted, on 29 August 2013, by clause 7(1) of the Electricity Industry Participation (Metering Arrangements) Code Amendment 2013.

Clause 7(1)(h): amended, on 1 February 2019, by clause 48(1)(a) of the Electricity Industry Participation Code Amendment (Code Review Programme) 2018.

Clause 7(1)(h)(ii): replaced, on 1 February 2019, by clause 48(1)(b) of the Electricity Industry Participation Code Amendment (Code Review Programme) 2018.

Clause 7(1)(h)(iia): inserted, on 1 February 2019, by clause 48(1)(b) of the Electricity Industry Participation Code Amendment (Code Review Programme) 2018.

Clause 7(1)(h)(iib): inserted, on 1 February 2019, by clause 48(1)(b) of the Electricity Industry Participation Code Amendment (Code Review Programme) 2018.

Clause 7(1)(j): amended, on 1 November 2018, by clause 48(2) of the Electricity Industry Participation Code Amendment (Code Review Programme) 2018.

Clause 7(1)(o) and (p): inserted, on 29 August 2013, by clause 5(1) of the Electricity Industry Participation (Additional Registry Fields) Code Amendment 2012.

Clause 7(1)(p), (2A) and (2B): amended, on 5 October 2017, by clause 225(4) of the Electricity Industry Participation Code Amendment (Code Review Programme) 2017.

Clause 7(1A): inserted, on 29 August 2013, by clause 7(2) of the Electricity Industry Participation (Metering Arrangements) Code Amendment 2013.

Clause 7(2): amended, on 29 August 2013, by clause 5(2) of the Electricity Industry Participation (Additional Registry Fields) Code Amendment 2012.

Clause 7(2A) and (2B): inserted, on 29 August 2013, by clause 5(3) of the Electricity Industry Participation (Additional Registry Fields) Code Amendment 2012.

Clause 7(4): amended, on 23 February 2015, by clause 75 of the Electricity Industry Participation Code Amendment (Distributed Generation) 2014.

Clause 7(5): amended, on 23 February 2015, by clause 75 of the Electricity Industry Participation Code Amendment (Distributed Generation) 2014.

Clause 7(6): amended, on 21 September 2012, by clause 15(1) of the Electricity Industry Participation (Minor Amendments) Code Amendment 2012.

Clause 7(6)(b)(iii): amended, on 23 February 2015, by clause 75 of the Electricity Industry Participation Code Amendment (Distributed Generation) 2014.

Clause 7(8) and (9): inserted, on 29 August 2013, by clause 5(4) of the Electricity Industry Participation (Additional Registry Fields) Code Amendment 2012.

8 Distributors to change ICP information provided to registry manager

- (1) If information about an **ICP** provided to the **registry manager** in accordance with clause 7 changes, the **distributor** in whose **network** the **ICP** is located must give written notice to the **registry manager** of the change.
- (2) Subject to subclause (2A), the **distributor** must give the notice—
 - (a) in the case of a change to the information referred to in clause 7(1)(b) (other than a change that is the result of the **commissioning** or **decommissioning** of an **NSP**), no later than **8 business days** after the change takes effect; and
 - (aa) in the case of a change to the information provided under clauses 7(1)(g), 7(1)(h) and 7(1)(i), where the change is backdated, no later than **3 business days** after the **distributor** and the **trader** responsible for the **ICP** have agreed on the change; and
 - (ab) in the case of **decommissioning** an **ICP**, by the later of—
 - (i) **3 business days** after the **registry manager** has advised the **distributor** under clause 11.29 that the **ICP** is ready to be **decommissioned**; and
 - (ii) **3 business days** after the **distributor** has **decommissioned** the **ICP**; and
 - (b) in every other case, no later than **3 business days** after the change takes effect.
- (2A) Where the functioning of the **registry** prevents the **distributor** from updating the **registry** until after a **metering equipment provider** has completed its obligations relating to the **ICP** in accordance with Schedule 11.4, the timeframes in subclause (2) start from the day the **metering equipment provider** completes those obligations.
- (3) A **distributor** is not required to give written notice if information provided in accordance with clause 7(1)(b) changes, and applies for less than **10 business days**.
- (4) If information provided under clause 7(1)(b) changes, and applies for **10 business days** or more, the **distributor** must—
 - (a) give the notice under subclause (1) no later than **13 business days** after the change takes effect; and
 - (b) include in the notice the date the change occurred as the effective date for the change.

Compare: Electricity Governance Rules 2003 clause 2A schedule E1
Clause 8 Heading: amended, on 5 October 2017, by clause 226(1) of the Electricity Industry Participation Code Amendment (Code Review Programme) 2017.
Clause 8(1): amended, on 5 October 2017, by clause 226(2) of the Electricity Industry Participation Code Amendment (Code Review Programme) 2017.
Clause 8(2): amended, on 5 October 2017, by clause 226(3) of the Electricity Industry Participation Code Amendment (Code Review Programme) 2017.
Clause 8(2): amended, on 1 March 2024, by clause 49(1) of the Electricity Industry Participation Code Amendment (Code Review Programme) 2024
Clause 8(2)(a): amended, on 1 November 2018, by clause 49(1)(a) of the Electricity Industry Participation Code Amendment (Code Review Programme) 2018.
Clause 8(2)(a): amended, on 1 March 2024, by clause 49(2) of the Electricity Industry Participation Code Amendment (Code Review Programme) 2024.
Clause 8(2)(aa): inserted, on 31 November 2021, by clause 36 of the Electricity Industry Participation Code Amendment (Code Review Programme) 2019.
Clause 8(2)(aa): amended, on 1 March 2024, by clause 49(3) of the Electricity Industry Participation Code Amendment (Code Review Programme) 2024.
Clause 8(2)(ab): inserted, on 1 November 2018, by clause 49(1)(b) of the Electricity Industry Participation Code Amendment (Code Review Programme) 2018.
Clause 8(2)(ab)(ii): amended, on 1 March 2024, by clause 49(4) of the Electricity Industry Participation Code Amendment (Code Review Programme) 2024.
Clause 8(2A): inserted, on 1 March 2024, by clause 49(5) of the Electricity Industry Participation Code Amendment (Code Review Programme) 2024.
Clause 8(3): amended, on 1 August 2019, by clause 49(2) of the Electricity Industry Participation Code Amendment (Code Review Programme) 2018.
Clause 8(3): amended, on 5 October 2017, by clause 226(4) of the Electricity Industry Participation Code Amendment (Code Review Programme) 2017.
Clause 8(4): replaced, on 1 August 2019, by clause 49(3) of the Electricity Industry Participation Code Amendment (Code Review Programme) 2018.

9 Traders to provide ICP information to registry manager

- (1) Each **trader** must provide the following information to the **registry manager** for each **ICP** for which it is recorded in the **registry** as having responsibility:
- (a) the **participant identifier** of the **trader**;
 - (b) the **profile** code of each **profile** at that **ICP** approved by the **Authority** in accordance with clause 13 of Schedule 15.5;
 - (c) the **participant identifier** of the **metering equipment provider** for each **category 1 metering installation**, or higher category **metering installation**, for the **ICP**;
 - (d) *[Revoked]*
 - (e) *[Revoked]*
 - (ea) the type of **submission information** that the **trader** will provide to the **reconciliation manager** for the **ICP**;
 - (f) if the settlement type UNM is assigned to the **ICP**—
 - (i) if the load is profiled through an engineering **profile** in accordance with **profile class 2.1**, the code ENG; or
 - (ii) in all other cases, the daily average **unmetered load** in kWh at the **ICP**;
 - (g) the type and capacity of the **unmetered load** at the **ICP** (if any);
 - (h) *[Revoked]*
 - (i) *[Revoked]*
 - (j) the status of the **ICP** determined in accordance with clauses 12 to 20.
 - (k) except as provided in subclause (1A), the relevant business classification code applicable to the customer at the **ICP**, in accordance with business classification codes **published** by the **Authority**.

- (1A) A **trader** must not provide the information specified in subclause (1)(k) if—
 - (a) the **ICP** exists for the purpose of reconciling **embedded network** residual load; or
 - (b) the **ICP** has "Distributor" status as specified in clause 16.
- (2) The **trader** must provide the information specified in subclause (1)(a) to subclause (1)(j) to the **registry manager** no later than 5 **business days** after the **trader** commences trading at the **ICP** to which the information relates.
- (3) The **trader** must provide the information specified in subclause (1)(k) to the **registry manager** no later than 20 **business days** after the **trader** commences trading at the **ICP** to which the information relates.

Compare: Electricity Governance Rules 2003 clause 3 schedule E1

Clause 9 Heading: amended, on 5 October 2017, by clause 227(1) of the Electricity Industry Participation Code Amendment (Code Review Programme) 2017.

Clause 9(1): amended, on 29 August 2013, by clause 8(1) of the Electricity Industry Participation (Metering Arrangements) Code Amendment 2013.

Clause 9(1): amended, on 5 October 2017, by clause 227(2) of the Electricity Industry Participation Code Amendment (Code Review Programme) 2017.

Clause 9(1)(c): amended, on 29 August 2013, by clause 8(2) of the Electricity Industry Participation (Metering Arrangements) Code Amendment 2013.

Clause 9(1)(d): substituted, on 1 December 2011, by clause 14 of the Electricity Industry Participation Code (Distributor Use-of-System Agreements and Distributor Tariffs) Amendment 2011.

Clause 9(1)(d): amended, on 21 September 2012, by clause 15(2) of the Electricity Industry Participation (Minor Amendments) Code Amendment 2012.

Clause 9(1)(d): revoked, on 29 August 2013, by clause 8(3) of the Electricity Industry Participation (Metering Arrangements) Code Amendment 2013.

Clause 9(1)(e): revoked, on 15 May 2014, by clause 24 of the Electricity Industry Participation (Minor Code Amendments) Code Amendment 2014.

Clause 9(1)(ea): inserted, on 29 August 2013, by clause 8(5) of the Electricity Industry Participation (Metering Arrangements) Code Amendment 2013.

Clause 9(1)(f): amended, on 29 August 2013, by clause 8(6) of the Electricity Industry Participation (Metering Arrangements) Code Amendment 2013.

Clause 9(1)(h) and (i): revoked, on 29 August 2013, by clause 8(7) and (8) of the Electricity Industry Participation (Metering Arrangements) Code Amendment 2013.

Clause 9(1)(k): inserted, on 29 August 2013, by clause 5(5) of the Electricity Industry Participation (Additional Registry Fields) Code Amendment 2012 and Clause 8(9) of the Electricity Industry Participation (Metering Arrangements) Code Amendment 2013.

Clause 9(1)(k): amended, on 1 November 2018, by clause 50 of the Electricity Industry Participation Code Amendment (Code Review Programme) 2018.

Clause 9(1A): inserted, on 29 August 2013, by clause 8(9) of the Electricity Industry Participation (Metering Arrangements) Code Amendment 2013.

Clause 9(2): amended, on 29 August 2013, by clause 8(10) of the Electricity Industry Participation (Metering Arrangements) Code Amendment 2013.

Clause 9(2) and (3): amended, on 5 October 2017, by clause 227(3) of the Electricity Industry Participation Code Amendment (Code Review Programme) 2017.

Clause 9(3): inserted, on 29 August 2013, by clause 8(11) of the Electricity Industry Participation (Metering Arrangements) Code Amendment 2013.

10 Traders to change ICP information provided to registry manager

- (1) If information about an **ICP** provided to the **registry manager** in accordance with clause 9 changes, the **trader** who trades at the **ICP** must give written notice to the **registry manager** of the change.
- (2) Subject to subclause (2A) the **trader** must give the notice no later than 5 **business days** after the change.
- (2A) Where the functioning of the **registry** prevents the **trader** from updating the **registry** until after the **metering equipment provider** has completed its obligations relating to the **ICP** in accordance with Schedule 11.4, the timeframes in subclause (2) start from the day the **metering equipment provider** has completed those obligations.

(3) *[Revoked]*

(4) *[Revoked]*

Compare: Electricity Governance Rules 2003 clause 3A schedule E1

Clause 10 Heading: amended, on 5 October 2017, by clause 228(1) of the Electricity Industry Participation Code Amendment (Code Review Programme) 2017.

Clause 10(1): amended, on 5 October 2017, by clause 228(2) of the Electricity Industry Participation Code Amendment (Code Review Programme) 2017.

Clause 10(2): amended, on 1 March 2024, by clause 50(1) of the Electricity Industry Participation Code Amendment (Code Review Programme) 2024.

Clause 10(2A): inserted, on 1 March 2024, by clause 50(2) of the Electricity Industry Participation Code Amendment (Code Review Programme) 2024.

Clause 10(2) and (3): amended, on 5 October 2017, by clause 228(3) of the Electricity Industry Participation Code Amendment (Code Review Programme) 2017.

Clause 10(3) and (4): inserted, on 29 August 2013, by clause 9 of the Electricity Industry Participation (Metering Arrangements) Code Amendment 2013 and expire on 26 September 2013.

Clauses 10(3) and (4): revoked, on 1 March 2024, by clause 50(3) of the Electricity Industry Participation Code Amendment (Code Review Programme) 2024.

11 Correction of errors in the registry

(1) By 0900 hours on the 1st **business day** of each **reconciliation period**, the **registry manager** must provide to each **participant** who is required to submit **submission information**, the following:

(a) a list of the **ICPs** at which the **participant** is recorded on the **registry** as **trading** during each **consumption period** being revised in the **reconciliation period**:

(b) all information associated with the **participant's participant identifier**, including the **profiles** for each **ICP**.

(2) If there is an error in the information provided under subclause (1), the **participant** must change the information in the **registry** as soon as practicable after becoming aware of the error.

Compare: Electricity Governance Rules 2003 clause 3B schedule E1

Clause 11(1): amended, on 5 October 2017, by clause 229 of the Electricity Industry Participation Code Amendment (Code Review Programme) 2017.

Management of ICP status

12 Management of ICP status by distributors and traders

The status of an **ICP**, as recorded on the **registry**, must be managed by **distributors** and **traders** in accordance with clauses 13 to 20.

Compare: Electricity Governance Rules 2003 clause 4 schedule E1

13 "New" status

The **ICP** status of "New" must be managed by the relevant **distributor** and indicates that—

(a) the associated **electrical facilities** are in the construction phase; and

(b) the **ICP** is not ready for the **trader** to authorise the **electrical connection** of the **ICP**.

Compare: Electricity Governance Rules 2003 clause 4.1 schedule E1

Clauses 13(a): amended, on 1 March 2024, by clause 51 of the Electricity Industry Participation Code Amendment (Code Review Programme) 2024.

Clause 13(b): amended, on 5 October 2017, by clause 230 of the Electricity Industry Participation Code Amendment (Code Review Programme) 2017.

14 “Ready” status

- (1) The **ICP** status of “Ready” must be managed by the relevant **distributor** and indicates that—
 - (a) the associated **electrical facilities** are ready for connecting to the **electricity** supply; or
 - (b) the **ICP** is ready for the **trader** to authorise the **electrical connection** of the **ICP**.
- (2) Before an **ICP** is given the "Ready" status, the relevant **distributor** must—
 - (a) identify the **trader** that has taken responsibility for the **ICP**; and
 - (b) ensure that the **ICP** has a single **price category** code.

Compare: Electricity Governance Rules 2003 clauses 4.2 and 4.3 schedule E1

Clause 14(1): amended, on 5 October 2017, by clause 231 of the Electricity Industry Participation Code Amendment (Code Review Programme) 2017.

Clause 14(1)(a): amended, on 15 May 2014, by clause 25 of the Electricity Industry Participation (Minor Code Amendments) Code Amendment 2014.

Clause 14(1)(a): amended, on 23 February 2015, by clause 75 of the Electricity Industry Participation Code Amendment (Distributed Generation) 2014.

Clause 14(1)(a): amended, on 1 March 2024, by clause 52 of the Electricity Industry Participation Code Amendment (Code Review Programme) 2024.

15 "New" or "Ready" status for 24 months or more

- (1) Subclause (2) applies if—
 - (a) an **ICP** has had the status of "New" for 24 months or more; or
 - (b) an **ICP** has had the status of "Ready" for 24 months or more.
- (2) The **distributor** must—
 - (a) ask the **trader** who intends to trade at the **ICP** whether the **ICP** should continue to have that status; and
 - (b) **decommission** the **ICP** if the **trader** advises that the **ICP** should not continue to have that status.

Compare: Electricity Governance Rules 2003 clause 4.3A schedule E1

Clause 15 Heading: amended, on 5 October 2017, by clause 232 (1) of the Electricity Industry Participation Code Amendment (Code Review Programme) 2017.

Clause 15: substituted, on 15 May 2014, by clause 26 of the Electricity Industry Participation (Minor Code Amendments) Code Amendment 2014.

Clause 15(1): amended, on 5 October 2017, by clause 232(2) of the Electricity Industry Participation Code Amendment (Code Review Programme) 2017.

Clause 15(2)(b): amended, on 5 October 2017, by clause 232(3) of the Electricity Industry Participation Code Amendment (Code Review Programme) 2017.

16 “Distributor” status

- (1) The **ICP** status of “Distributor” must be managed by the relevant **distributor** and indicates that the **ICP** record represents a **shared unmetered load** installation or the **point of connection** between an **embedded network** and its parent **network**.
- (2) A **trader** cannot change the status of an **ICP** record with the **ICP** status of “Distributor”.

Compare: Electricity Governance Rules 2003 clause 4.4 schedule E1

17 “Active” status

- (1) The **ICP identifier** status of “Active” must be managed by the relevant **trader** and indicates that—

- (a) the associated **electrical facilities** are **electrically connected**; and
 - (b) a **trader** must provide information related to the **ICP identifier**, in accordance with Part 15, to the **reconciliation manager** for the purpose of compiling **reconciliation information**.
- (2) Before an **ICP** is given the “Active” status, the **trader** must ensure that—
- (a) the **ICP identifier** has only 1 **embedded generator**, **direct purchaser**, or customer of a **retailer**; and
 - (b) the **electricity** consumed is quantified by a **metering installation** or a method of calculation approved by the **Authority**.

Compare: Electricity Governance Rules 2003 clauses 4.5 and 4.6 schedule E1

Clause 17(1)(a): amended, on 29 August 2013, by clause 18 of the Electricity Industry Participation (Metering Arrangements) Code Amendment 2011.

Clause 17(1)(a): amended, on 5 October 2017, by clause 233 of the Electricity Industry Participation Code Amendment (Code Review Programme) 2017.

Clause 17(2)(a): amended, on 1 November 2018, by clause 51 of the Electricity Industry Participation Code Amendment (Code Review Programme) 2018.

Clause 17(1): amended, on 31 October 2023, by clause 5 of the Electricity Industry Participation Code Amendment (Clarification of Trader Obligations) 2023.

Clause 17(2)(a): amended, on 31 October 2023, by clause 5 of the Electricity Industry Participation Code Amendment (Clarification of Trader Obligations) 2023.

Clause 17(1)(a): amended, on 1 March 2024, by clause 53 of the Electricity Industry Participation Code Amendment (Code Review Programme) 2024.

18 *[Revoked]*

Compare: Electricity Governance Rules 2003 clause 4.6A schedule E1

Clause 18: revoked, on 29 August 2013, by clause 5(7) of the Electricity Industry Participation (Additional Registry Fields) Code Amendment 2012.

19 “Inactive” status

The **ICP** status of “Inactive” must be managed by the relevant **trader** and indicates that—

- (a) the **ICP** is **electrically disconnected**; or
- (b) **submission information** related to the **ICP** is not required by the **reconciliation manager** for the purpose of compiling **reconciliation information**.

Compare: Electricity Governance Rules 2003 clause 4.7 schedule E1

Clause 19(a): substituted, on 29 August 2013, by clause 20 of the Electricity Industry Participation (Metering Arrangements) Code Amendment 2011.

Clause 19(a): amended, on 5 October 2017, by clause 234 of the Electricity Industry Participation Code Amendment (Code Review Programme) 2017.

20 “Decommissioned” status

- (1) The **ICP** status of “Decommissioned” must be managed by the relevant **distributor** and indicates that the **ICP** is permanently removed from future switching and reconciliation processes.

(2) **Decommissioning** occurs when—

- (a) **electrical facilities** associated with the **ICP** are physically removed; or
- (b) there is a change in the allocation of electrical loads between **ICPs** with the effect of making the **ICP** obsolete; or
- (c) in the case of a **distributor-only ICP** for an **embedded network**, the **embedded network** no longer exists.

Compare: Electricity Governance Rules 2003 clause 4.8 schedule E1
Clause 20(2): amended, on 5 October 2017, by clause 235 of the Electricity Industry Participation Code Amendment (Code Review Programme) 2017.
Clause 20(2)(a): amended, on 1 March 2024, by clause 54 of the Electricity Industry Participation Code Amendment (Code Review Programme) 2024.

Updating registry standing information

21 Updating table of loss category codes

- (1) Each **distributor** must keep up to date the table in the **registry** of the **loss category** codes that may be assigned to **ICPs** on each **distributor's network**, by entering in the table any new **loss category** codes that may be assigned to an **ICP** on the **distributor's network**.
- (2) Each entry in the table must specify the date on which each **loss category** code takes effect.
- (3) The date that a **loss category** code takes effect must not be earlier than 2 months after the date on which the **loss category** code is entered in the table.
- (4) A **loss category** code takes effect on the specified date.
- (5) To avoid doubt, subclause (3) does not apply to the creation of an **ICP** or to the transfer of an **ICP** from 1 **distributor's network** to another **distributor's network**.

Compare: Electricity Governance Rules 2003 clause 5 schedule E1

22 Updating loss factors for loss category codes

- (1) A **distributor** must enter **loss factors** in the **registry** for each **loss category** code entered on the table in the **registry** under clause 21.
- (2) A **distributor** must ensure that—
 - (a) each **loss category** code has no more than 2 **loss factors** in a calendar month; and
 - (b) each **loss factor** covers a range of **trading periods** within that month so that all **trading periods** have a single applicable **loss factor**.
- (3) A **distributor** who wishes to replace an existing **loss factor** on the table in the **registry** must enter the replaced **loss factor** on the table in the **registry**.
- (4) Each entry in the table must specify the date on which the replaced **loss factor** takes effect.
- (5) The date that a **loss factor** takes effect must not be earlier than 2 months after the date on which the **loss factor** is entered in the table.
- (6) A replaced **loss factor** takes effect on the specified date.
- (7) To avoid doubt, subclause (5) does not apply to the creation of an **ICP** or to the transfer of an **ICP** from 1 **distributor's network** to another **distributor's network**.
- (8) The **registry manager** must **publish** an updated schedule of all **loss category** codes and the **loss factors** for each **loss category** code no later than 1 **business day** after receiving notice of a change.

Compare: Electricity Governance Rules 2003 clause 5A schedule E1
Clause 22(1): amended, on 5 October 2017, by clause 236(1) of the Electricity Industry Participation Code Amendment (Code Review Programme) 2017.
Clause 22(8): amended, on 21 September 2012, by clause 15(3) of the Electricity Industry Participation (Minor Amendments) Code Amendment 2012.
Clause 22(8): amended, on 5 October 2017, by clause 236(2) of the Electricity Industry Participation Code Amendment (Code Review Programme) 2017.

23 Updating table of price category codes

- (1) Each **distributor** must keep up to date the table in the **registry** of the **price category** codes that may be assigned to **ICPs** on each **distributor's network**, by entering in the table any new **price category** codes that may be assigned to an **ICP** on the **distributor's network**.
- (2) Each entry in the table must specify the date on which each **price category** code takes effect.
- (3) The date that a **price category** code takes effect must not be earlier than 2 months after the date on which the **price category** code is entered in the table.
- (4) A **price category** code takes effect on the specified date.
- (5) To avoid doubt, subclause (3) does not apply to the creation of an **ICP** or to the transfer of an **ICP** from 1 **distributor's network** to another **distributor's network**.

Compare: Electricity Governance Rules 2003 clause 6 schedule E1

24 Balancing area information

- (1) A **distributor** must give written notice to the **reconciliation manager** of the establishment of a **balancing area** associated with an **NSP** supplying the **distributor's network**, in accordance with clause 26.
- (2) A **distributor** must give written notice to the **reconciliation manager** of any change to the information provided under subclause (1).
- (3) The notice must—
 - (a) specify the date and **trading period** from which the change takes effect; and
 - (b) be given no later than 3 **business days** after the change takes effect.
- (4) The **reconciliation manager** must give written notice to the **registry manager** of changes to **balancing areas** within 1 **business day** after receiving the notice.
- (5) The **registry manager** must **publish** an updated schedule of the mapping between **NSPs** and **balancing areas** within 1 **business day** after receiving the notice.
- (6) The schedule must specify the date and **trading period** from which the change took effect.

Compare: Electricity Governance Rules 2003 clause 7 schedule E1

Clause 24(1), (2) and (4): amended, on 5 October 2017, by clause 237(1) of the Electricity Industry Participation Code Amendment (Code Review Programme) 2017.

Clause 24(3), (4) and (5): amended, on 5 October 2017, by clause 237(3) of the Electricity Industry Participation Code Amendment (Code Review Programme) 2017.

Clause 24(4) and (5): amended, on 5 October 2017, by clause 237(2) of the Electricity Industry Participation Code Amendment (Code Review Programme) 2017.

25 Creation and decommissioning of NSPs and transfer of ICPs from 1 distributor's network to another distributor's network

- (1) If an **NSP** is to be created or **decommissioned**,—
 - (a) the **participant** specified in subclause (3) in relation to the **NSP** must give written notice to the **reconciliation manager** of the creation or **decommissioning**; and
 - (b) the **reconciliation manager** must give written notice to the **Authority** and affected **reconciliation participants** of the creation or **decommissioning** no later than 1 **business day** after receiving the notice in paragraph (a).

- (2) If a **distributor** wishes to change the record in the **registry** of an **ICP** that is not recorded as being usually connected to an **NSP** in the **distributor's network**, to transfer the **ICP** so that it is recorded as being usually connected to an **NSP** in the **distributor's network**, the **distributor** must give written notice to the **reconciliation manager**, the **Authority**, and each affected **reconciliation participant** of the transfer.
- (3) The notice required by subclause (1) must be given by—
 - (a) the **grid owner**, if—
 - (i) the **NSP** is a **point of connection** between the **grid** and a **local network**; or
 - (ii) if the **NSP** is a **point of connection** between a **generator** and the **grid**; or
 - (b) the **distributor** for the **local network** who initiated the creation or **decommissioning**, if the **NSP** is an **interconnection point** between 2 **local networks**; or
 - (c) the **embedded network** owner who initiated the creation or **decommissioning**, if the **NSP** is an **interconnection point** between 2 **embedded networks**; or
 - (d) the **distributor** for the **embedded network**, if the **NSP** is a **point of connection** between an **embedded network** and another **network**.
- (4) A **distributor** who is required to give written notice of a transfer under subclause (2) or subclause (3)(d) must comply with Schedule 11.2.
- (5) The **participant** required to give notice under subclause (1) must give notice no later than 30 days prior to the intended date of creation or **decommissioning** of the **NSP**.
- (6) If a **participant** changes the intended date of creation or **decommissioning** after giving notice under subclause (1), the **participant** must give a replacement notice advising the new intended date of creation or **decommissioning**, as soon as possible after the **participant** decides to change the intended date.
- (7) An **embedded network** owner must not give written notice of **decommissioning** an **NSP** under subclause (3)(c) or subclause (3)(d) unless—
 - (a) the **embedded network** owner has changed the status in the **registry** of all **ICPs** recorded as being usually connected to the **NSP** to 'Decommissioned'; or
 - (b) a **distributor** has changed the record in the **registry** of each **ICP** previously recorded as being usually connected to the **NSP**, and with a status in the **registry** of 'Active' or 'Inactive', to record the **ICP** as being usually connected to an **NSP** in the **distributor's network**; or
 - (c) a combination of the changes described in paragraphs (a) and (b) has occurred, so that no **ICP** with a status in the **registry** of 'Active' or 'Inactive' is recorded as being connected to the **NSP** that is to be **decommissioned**.

Compare: Electricity Governance Rules 2003 clause 8 schedule E1

Clause 25(1), (2), (3) and (4): amended, on 5 October 2017, by clause 238(1) to (6) of the Electricity Industry Participation Code Amendment (Code Review Programme) 2017.

Clause 25(2): amended, on 23 February 2015, by clause 75 of the Electricity Industry Participation Code Amendment (Distributed Generation) 2014.

Clause 25(2): amended, on 1 March 2022, by clause 37(1)(a) and (b) of the Electricity Industry Participation Code Amendment (Code Review Programme) 2019.

Clause 25(5) and 25(6): inserted, on 1 February 2021, by clause 45 of the Electricity Industry Participation Code Amendment (Metering and Related Registry Processes) 2020.

Clause 25(7): inserted, on 1 March 2022, by clause 37(2) of the Electricity Industry Participation Code Amendment (Code Review Programme) 2019.

26 Information to be provided if NSPs are created or ICPs are transferred from 1 distributor's network to another distributor's network

- (1) If a **participant** gives notice under clause 25(1) or (2) of the creation of an **NSP** or the transfer of an **ICP** from 1 **distributor's network** to another **distributor's network**, the **participant** must request that the **reconciliation manager** create a unique **NSP identifier** for the **NSP**.
- (2) The **participant** must make the request—
 - (a) in the case of notice given under clause 25(3)(b) or (c), at least 10 **business days** before the **NSP** is **electrically connected**; and
 - (b) in every other case, at least 1 month before the **NSP** is **electrically connected** or the **ICP** is transferred.
- (3) If a **participant** gives notice under clause 25(1) of the creation of an **NSP**, the **distributor** on whose **network** the **NSP** is located must give the **reconciliation manager** the following information:
 - (a) if the **NSP** is to be located in a new **balancing area** to be created—
 - (i) all relevant details necessary for the **balancing area** to be created; and
 - (ii) notice that the **NSP** to be created is to be assigned to the new **balancing area**; and
 - (b) in every other case, notice of the **balancing area** in which the **NSP** is located.
- (4) If a **participant** gives notice under clause 25(1) or (2) of a creation or transfer that relates to an **NSP** between a **network** and an **embedded network**, the **distributor** who owns the **embedded network** must give written notice to the **reconciliation manager** of the following:
 - (a) the **network** on which the **NSP** will be located after the creation or transfer;
 - (b) the **ICP identifier** for the **ICP** that connects the **network** and the **embedded network**;
 - (c) the date on which the creation or transfer will take effect.
- (5) The **distributor** must give the notice at least 1 month before the creation or transfer.

Compare: Electricity Governance Rules 2003 clause 9 schedule E1

Clause 26(1): amended, on 5 October 2017, by clause 239(1) of the Electricity Industry Participation Code Amendment (Code Review Programme) 2017.

Clause 26(2): amended, on 5 October 2017, by clause 239(2) and (3) of the Electricity Industry Participation Code Amendment (Code Review Programme) 2017.

Clause 26(2)(a) and (b): amended, on 23 February 2015, by clause 75 of the Electricity Industry Participation Code Amendment (Distributed Generation) 2014.

Clause 26(3): amended, on 21 September 2012, by clause 15(4) of the Electricity Industry Participation (Minor Amendments) Code Amendment 2012.

Clause 26(3): amended, on 5 October 2017, by clause 239(4) of the Electricity Industry Participation Code Amendment (Code Review Programme) 2017.

Clause 26(4): amended, on 5 October 2017, by clause 239(1) and (5) of the Electricity Industry Participation Code Amendment (Code Review Programme) 2017.

Clause 26(5): amended, on 5 October 2017, by clause 239(3) and (6) of the Electricity Industry Participation Code Amendment (Code Review Programme) 2017.

27 Information to be provided if ICPs become NSPs

- (1) If a transfer for which notice is given under clause 25 results in an **ICP** becoming an **NSP** at which an **embedded network** connects to a **network**, or in an **ICP** becoming an **NSP** that is an **interconnection point**, the **distributor** who owns the **network** on which

the **NSP** will be located after the change must give written notice to any **trader** trading at the **ICP** of the transfer.

- (2) The **distributor** must give the notice at least 1 month before the transfer.

Compare: Electricity Governance Rules 2003 clause 10 schedule E1

Clause 27(1): amended, on 5 October 2017, by clause 240(1) of the Electricity Industry Participation Code Amendment (Code Review Programme) 2017.

Clause 27(2): amended, on 5 October 2017, by clause 240(2) of the Electricity Industry Participation Code Amendment (Code Review Programme) 2017.

28 Reconciliation manager to allocate new identifiers

The **reconciliation manager** must, within 1 **business day** of receiving notice under clause 25(1) or (2), allocate a unique **NSP identifier** to each **point of connection** or **interconnection point** to which the notice relates in accordance with the following format:

bbbqqqz nnnn

where

bbbqqqz is, in the case of a **local network**, the code for the **GXP** or **GIP** or, in the case of an **embedded network** or the **point of connection** between **2 local networks**, the code for the **point of connection** to its parent **network**

where

bbb is a combination of 3 alpha characters that form a unique location identifier

qqq is the voltage in kV of the supply bus

z is a numeral allocated to distinguish it from any other supply bus of the same voltage at the same location

nnnn is a **participant identifier** for the **network** owner who from time to time owns the **network** being supplied.

Compare: Electricity Governance Rules 2003 clause 11 schedule E1

Clause 28: amended, on 5 October 2017, by clause 241 of the Electricity Industry Participation Code Amendment (Code Review Programme) 2017.

29 Obligations concerning change in network owner

- (1) If a **network** owner acquires all or part of an existing **network**, the **network** owner must give written notice to the following of the acquisition:

- (a) the previous **network** owner:
- (b) the **reconciliation manager**:
- (c) the **Authority**:

- (d) every **reconciliation participant** who trades at an **ICP** connected to the **network** or part of the **network** acquired.
- (2) The **network** owner must give the notice at least 1 month before the acquisition.
- (3) The notice must specify—
 - (a) the **ICP identifiers** for which the **network** owner's **participant identifier** must be amended to reflect the acquisition of the **network** or part of the **network** by the **network** owner; and
 - (b) the effective date of the acquisition.
- (4) A **network** owner who acquires all or part of an existing **network** must comply with Schedule 11.2.

Compare: Electricity Governance Rules 2003 clause 12 schedule E1

Clause 29(1): amended, on 5 October 2017, by clause 242(1) of the Electricity Industry Participation Code Amendment (Code Review Programme) 2017.

Clause 29(1)(d): amended, on 23 February 2015, by clause 75 of the Electricity Industry Participation Code Amendment (Distributed Generation) 2014.

Clause 29(2): amended, on 5 October 2017, by clause 242(2) and (3) of the Electricity Industry Participation Code Amendment (Code Review Programme) 2017.

Clause 29(3): amended, on 5 October 2017, by clause 242(3) of the Electricity Industry Participation Code Amendment (Code Review Programme) 2017.

30 Reconciliation manager to advise registry manager

- (1) The **reconciliation manager** must—
 - (a) advise the **registry manager** of any new or deleted **NSP identifier** no later than 1 **business day** after receiving notice of its creation or deletion; and
 - (b) advise the **registry manager** of any changes to supporting **NSP** information provided by a **distributor** in accordance with clause 26(4) no later than 1 **business day** after receiving the notice.
- (2) The **registry manager** must **publish** an updated schedule of all **NSP identifiers** and supporting information within 1 **business day** of receiving notice in accordance with subclause (1).

Compare: Electricity Governance Rules 2003 clause 13 schedule E1

Clause 30 Heading: amended, on 5 October 2017, by clause 243(1) of the Electricity Industry Participation Code Amendment (Code Review Programme) 2017.

Clause 30(1): amended, on 5 October 2017, by clause 243(2) and (3) of the Electricity Industry Participation Code Amendment (Code Review Programme) 2017.

Clause 30(2): amended, on 5 October 2017, by clause 243(3) and (4) of the Electricity Industry Participation Code Amendment (Code Review Programme) 2017.

Schedule 11.2

cls 25 and 29 of Schedule 11.1

Transfer of ICPs between distributors' networks

- 1 This Schedule applies if a **distributor** (the applicant **distributor**) wishes to change the record in the **registry** of an **ICP** that is not recorded as being usually connected to an **NSP** in the **distributor's network**, to transfer the **ICP** so that it is recorded as being usually connected to an **NSP** in the applicant **distributor's network**.

Compare: Electricity Governance Rules 2003 clause 1 schedule E1A

Clause 1: amended, on 23 February 2015, by clause 75 of the Electricity Industry Participation Code Amendment (Distributed Generation) 2014.

Clause 1: amended, on 5 October 2017, by clause 244 of the Electricity Industry Participation Code Amendment (Code Review Programme) 2017.

Clause 1: amended, on 1 March 2022, by clause 38(1)(a) and (b) of the Electricity Industry Participation Code Amendment (Code Review Programme) 2019.

- 2 The applicant **distributor** must give written notice to the **Authority** of the transfer.

Compare: Electricity Governance Rules 2003 clause 2 schedule E1A

Clause 2: amended, on 5 October 2017, by clause 245 of the Electricity Industry Participation Code Amendment (Code Review Programme) 2017.

- 3 The notice must be in the **prescribed form**.

Compare: Electricity Governance Rules 2003 clause 3 schedule E1A

Clause 3: amended, on 5 October 2017, by clause 246 of the Electricity Industry Participation Code Amendment (Code Review Programme) 2017.

- 4 The notice must be given no later than 3 **business days** before the transfer takes effect.

Compare: Electricity Governance Rules 2003 clause 4 schedule E1A

Clause 4: amended, on 5 October 2017, by clause 247 of the Electricity Industry Participation Code Amendment (Code Review Programme) 2017.

- 5 The applicant **distributor** must give the **Authority** confirmation that the applicant **distributor** has received written consent to the proposed transfer from—

- (a) the **distributor** whose **network** is associated with the **NSP** to which the **ICP** is recorded as being connected immediately before the notice, except if the notice relates to the creation of an **embedded network**; and
- (b) every **trader** who trades **electricity** at any **ICP** nominated at the time of notice as being supplied from the same **NSP** to which the notice relates.

Compare: Electricity Governance Rules 2003 clause 5 schedule E1A

Clause 5(a): amended, on 23 February 2015, by clause 75 of the Electricity Industry Participation Code Amendment (Distributed Generation) 2014.

Clause 5: amended, on 5 October 2017, by clause 248 of the Electricity Industry Participation Code Amendment (Code Review Programme) 2017.

- 5A For the purposes of clause 5, the **distributor** (under subclause 5(a)) or the **trader** (under subclause 5(b)) is deemed to have consented to the proposed transfer if the applicant **distributor** has requested in writing the **distributor's** or **trader's** written consent and—

- (a) the **distributor** or **trader** (as the case may be)—

- (i) has not provided written consent; and
- (ii) has not indicated in writing that it refuses to give written consent; and
- (b) more than 40 **business days** (or such other period as the applicant **distributor** agrees with the **distributor** or **trader**) have passed since the applicant **distributor** requested the **distributor's** or **trader's** written consent; and
- (c) during the 40 **business days** (or such other period as the applicant **distributor** agrees with the **distributor** or **trader**) the applicant **distributor** has—
 - (i) checked the **registry** to ensure it has sought consent from the correct **distributor** or **trader**; and
 - (ii) made reasonable endeavours to contact the **distributor** or **trader** and obtain a response.

Clause 5A: inserted, on 1 March 2022, by clause 38(2) of the Electricity Industry Participation Code Amendment (Code Review Programme) 2019.

- 5B For the purposes of clause 5, the **distributor** (under subclause 5(a)) or the **trader** (under subclause 5(b)) must not unreasonably withhold consent to the proposed transfer.

Clause 5B: inserted, on 1 March 2022, by clause 38(2) of the Electricity Industry Participation Code Amendment (Code Review Programme) 2019.

- 6 If a notice relates to an **embedded network**, it must relate to every **ICP** on the **embedded network**.

Compare: Electricity Governance Rules 2003 clause 6 schedule E1A

Clause 6: amended, on 5 October 2017, by clause 249 of the Electricity Industry Participation Code Amendment (Code Review Programme) 2017.

- 7 The **Authority** must not authorise the change of any information in the **registry** if clauses 2 to 5 are not complied with.

Compare: Electricity Governance Rules 2003 clause 7 schedule E1A

Clause 7: amended, on 29 August 2013, by clause 10 of the Electricity Industry Participation (Metering Arrangements) Code Amendment 2013.

Clause 7: amended, on 15 May 2014, by clause 27 of the Electricity Industry Participation (Minor Code Amendments) Code Amendment 2014.

Clause 7: amended, on 5 October 2017, by clause 250 of the Electricity Industry Participation Code Amendment (Code Review Programme) 2017.

- 7A Despite clause 7, the **Authority** may authorise the change if the applicant **distributor** has not given written notice to the **Authority** within the time frame required under clause 4, if—

- (a) the applicant **distributor** has complied with clauses 2, 3 and 5; and
- (b) the **Authority** considers that it has not been materially disadvantaged by the applicant **distributor's** failure to comply with clause 4.

Clause 7A: inserted, on 15 May 2014, by clause 28 of the Electricity Industry Participation (Minor Code Amendments) Code Amendment 2014.

Clause 7A: amended, on 5 October 2017, by clause 251 of the Electricity Industry Participation Code Amendment (Code Review Programme) 2017.

- 8 The notice must include any information requested by the **Authority** from time to time.

Compare: Electricity Governance Rules 2003 clause 8 schedule E1A

Clause 8: amended, on 5 October 2017, by clause 252 of the Electricity Industry Participation Code Amendment (Code Review Programme) 2017.

- 9 The **registry manager** must remove from the **registry** any information the **registry manager** has received under clause 7 of Schedule 11.1 if the information—
- (a) relates to an **ICP** for which an applicant **distributor** has given written notice of a transfer under this Schedule; and
 - (b) was to come into effect after the date on which the **Authority** authorises the change of information in the **registry** under this Schedule.

Compare: Electricity Governance Rules 2003 clause 9 schedule E1A
Clause 9: replaced, on 5 October 2017, by clause 253 of the Electricity Industry Participation Code Amendment (Code Review Programme) 2017.

- 10 A transfer may take effect on a date that is before the date on which the notice is given only with the consent of the **Authority**.

Compare: Electricity Governance Rules 2003 clause 10 schedule E1A
Clause 10: amended, on 5 October 2017, by clause 254 of the Electricity Industry Participation Code Amendment (Code Review Programme) 2017.

- 11 Each **reconciliation participant** must take a **validated meter reading** or **permanent estimate** on the date a transfer becomes effective for use in the creation of the **reconciliation participant's** submission file, unless the **Authority** authorises the **reconciliation manager** to provide additional **seasonal adjustment shapes** under clause 12.

Compare: Electricity Governance Rules 2003 clause 11 schedule E1A

- 12 The **Authority** may authorise the **reconciliation manager** to provide additional **seasonal adjustment shapes** for use in the creation of each **reconciliation participant's** submission file.

Compare: Electricity Governance Rules 2003 clause 12 schedule E1A

Schedule 11.3 Switching

cl 11.15

Overview

Cross heading: inserted on 9 October 2015, by clause 5(1) of the Electricity Industry Participation Code Amendment (ICP Switching) 2014.

1A Application of Schedule

- (1) This Schedule prescribes 3 processes for switching **ICPs** as follows:
 - (a) a standard switch process that applies in the circumstances described in clause 1(1):
 - (b) a switch move process that applies in the circumstances described in clause 8(1):
 - (c) a gaining **trader** switch process that applies in the circumstances described in clause 13(1).
- (2) If a **trader** proposes switching an **ICP**, the **trader** must use one of the switch processes set out in this Schedule.

Clause 1A Heading: amended, on 1 November 2018, by clause 52(1) of the Electricity Industry Participation Code Amendment (Code Review Programme) 2018.

Clause 1A: inserted on 9 October 2015, by clause 5(2) of the Electricity Industry Participation Code Amendment (ICP Switching) 2014.

Clause 1A(2): inserted, on 1 November 2018, by clause 52(2) of the Electricity Industry Participation Code Amendment (Code Review Programme) 2018.

Standard switch process

Cross heading: amended on 9 October 2015, by clause 6 of the Electricity Industry Participation Code Amendment (ICP Switching) 2014.

1 Standard switch process for ICPs

- (1) A standard switch process applies only when a **trader** (the "gaining **trader**") has an arrangement with a customer or **embedded generator** to commence trading **electricity** with the customer or **embedded generator** at, or to otherwise assume responsibility under clause 11.18(1) for, an **ICP** at which another **trader** (the "losing **trader**") trades **electricity**, and the gaining **trader** switch process under clauses 13 to 16 does not apply.
- (1A) This clause and clauses 2 to 7 apply to a standard switch process.
- (2) If subpart 2 of Part 4A of the Fair Trading Act 1986 applies to an arrangement described in subclause (1),—
 - (a) the gaining **trader** must identify the period within which the customer or **embedded generator** may cancel the arrangement in accordance with section 36M of the Fair Trading Act 1986; and
 - (b) for the purpose of this Schedule, the arrangement is deemed to come into effect on the day after the expiry of the period.

Compare: Electricity Governance Rules 2003 clauses 1.1A and 1.1B schedule E2

Clause 1 Heading: amended, on 29 August 2013, by clause 11(1) of the Electricity Industry Participation (Metering Arrangements) Code Amendment 2013.

Clause 1 Heading: amended on 9 October 2015, by clause 7(1) of the Electricity Industry Participation Code Amendment (ICP Switching) 2014.

Clause 1(1) and 1(1A): substituted on 9 October 2015, by clause 7(2) of the Electricity Industry Participation Code Amendment (ICP Switching) 2014.

Clause 1(1): amended, on 1 November 2018, by clause 53(1) and (2) of the Electricity Industry Participation Code Amendment (Code Review Programme) 2018.

Clause 1(1)(a): substituted, on 29 August 2013, by clause 11(2) of the Electricity Industry Participation (Metering Arrangements) Code Amendment 2013.

Clause 1(2): amended, on 6 November 2014, by clause 7(3) of the Electricity Industry Participation Code Amendment (ICP Switching) 2014.

Clause 1(2)(a): amended, on 6 November 2014, by clause 7(4) of the Electricity Industry Participation Code Amendment (ICP Switching) 2014.

Clause 1(2)(a): amended, on 1 November 2018, by clause 53(2) of the Electricity Industry Participation Code Amendment (Code Review Programme) 2018.

2 Gaining trader advises registry manager of standard switch request

(1) For each **ICP** to which a switch relates, the gaining **trader** must advise the **registry manager** of the switch no later than **2 business days** after the arrangement to trade **electricity** with the customer or the **embedded generator** comes into effect.

(2) The gaining **trader** must include in its advice to the **registry manager**—

(a) *[Revoked]*

(b) that the switch type is TR; and

(c) 1 or more **profile** codes of a **profile** at the **ICP**.

Compare: Electricity Governance Rules 2003 clause 1.1 schedule E2

Clause 2 Heading: substituted on 9 October 2015, by clause 8(1) of the Electricity Industry Participation Code Amendment (ICP Switching) 2014.

Clause 2 Heading: amended, on 5 October 2017, by clause 255(1) of the Electricity Industry Participation Code Amendment (Code Review Programme) 2017.

Clause 2(1) and (2): amended, on 5 October 2017, by clause 255(2) of the Electricity Industry Participation Code Amendment (Code Review Programme) 2017.

Clause 2(1): amended, on 1 November 2018, by clause 54 of the Electricity Industry Participation Code Amendment (Code Review Programme) 2018.

Clause 2(2): inserted on 9 October 2015, by clause 8(2) of the Electricity Industry Participation Code Amendment (ICP Switching) 2014.

Clause 2(2)(a): revoked on 9 October 2015, by clause 4 of the Electricity Industry Participation Code Amendment (ICP Switching) 2015.

3 Losing trader response to standard switch request

No later than **3 business days** after the date on which the **registry manager**, under clause 22(a), makes written notice of a switch request available to the losing **trader**, the losing trader must,—

(a) either—

(i) acknowledge the switch request by providing the following information to the **registry manager**:

(A) the proposed **event date**; and

(B) a valid switch response code approved by the **Authority**; or

(ii) provide the final information specified in clause 5(a) to (c) to complete the switch; or

(b) *[Revoked]*

(c) request that the switch be withdrawn in accordance with clause 17.

Compare: Electricity Governance Rules 2003 clause 1.2 schedule E2

Clause 3: substituted on 9 October 2015, by clause 9 of the Electricity Industry Participation Code Amendment (ICP Switching) 2014.

Clause 3: amended, on 5 October 2017, by clause 256 of the Electricity Industry Participation Code Amendment (Code Review Programme) 2017

Clause 3: amended, on 1 March 2022, by clause 39(a) & (b) of the Electricity Industry Participation Code Amendment (Code Review Programme) 2019.

Clause 3(a): substituted on 9 October 2015, by clause 5(1) of the Electricity Industry Participation Code Amendment (ICP Switching) 2015.

Clause 3(b): revoked on 9 October 2015, by clause 5(2) of the Electricity Industry Participation Code Amendment (ICP Switching) 2015.

4 Event dates

- (1) The **losing trader** must establish **event dates** so that—
 - (a) no **event date** is more than **10 business days** after the date on which the **registry manager**, under clause 22(a), makes written notice available to the **losing trader**; and
 - (b) in any 12 month period at least 50% of the **event dates** established by the **losing trader** are no more than **5 business days** after the date on which the **registry manager**, under clause 22(a), makes written notice available to the **losing trader**.
- (2) For the purpose of determining whether it complies with subclause (1)(b), the **losing trader** may disregard every **event date** it has established for an **ICP** for which, on the date on which the **registry manager**, under clause 22(a), made written notice available to the **losing trader**, the **losing trader** had been responsible for less than 2 months.

Compare: Electricity Governance Rules 2003 clause 1.2A schedule E2

Clause 4: replaced, on 1 March 2022, by clause 40 of the Electricity Industry Participation Code Amendment (Code Review Programme) 2019.

Clause 4(1): amended on 9 October 2015, by clause 6 of the Electricity Industry Participation Code Amendment (ICP Switching) 2015.

Clause 4(1): amended, on 5 October 2017, by clause 257(1) of the Electricity Industry Participation Code Amendment (Code Review Programme) 2017.

Clause 4(1)(a): amended, on 15 May 2014, by clause 29 of the Electricity Industry Participation (Minor Code Amendments) Code Amendment 2014.

Clause 4(2): amended on 9 October 2015, by clause 10 of the Electricity Industry Participation Code Amendment (ICP Switching) 2014.

Clause 4(2): amended, on 5 October 2017, by clause 257(2) of the Electricity Industry Participation Code Amendment (Code Review Programme) 2017.

Clause 4(2): replaced, on 1 November 2018, by clause 55 of the Electricity Industry Participation Code Amendment (Code Review Programme) 2018.

5 Losing trader must provide final information

If the **losing trader** has provided information under clause 3(a)(i) rather than under clause 3(a)(ii), no later than **5 business days** after the **event date**, the **losing trader** must complete the switch by providing final information to the **registry manager**, including—

- (a) the **event date**; and
- (b) a **switch event meter reading** as at the **event date** for each **meter** or **data storage device** that is recorded in the **registry** with an accumulator type of C and a settlement indicator of Y; and
- (c) if the **switch event meter reading** is not a **validated meter reading**, the date of the last **meter reading** of the **meter** or **data storage device** described in paragraph (b).

Compare: Electricity Governance Rules 2003 clause 1.3 schedule E2

Clause 5: substituted on 9 October 2015, by clause 11 of the Electricity Industry Participation Code Amendment (ICP Switching) 2014.

Clause 5: amended on 9 October 2015, by clause 7 of the Electricity Industry Participation Code Amendment (ICP Switching) 2015.

Clause 5: amended, on 5 October 2017, by clause 258 of the Electricity Industry Participation Code Amendment (Code Review Programme) 2017.

6 Traders must use same reading

- (1) The losing **trader** and the gaining **trader** must both use the same **switch event meter reading** for the **event date** as determined by the following procedure:
 - (a) if the **switch event meter reading** provided by the losing **trader** differs by less than 200 kWh from a value established by the gaining **trader**, the gaining **trader** must use the losing **trader's switch event meter reading**; or
 - (b) if the **switch event meter reading** provided by the losing **trader** differs by 200 kWh or more from a value established by the gaining **trader**, the gaining **trader** may dispute the **switch event meter reading**.
- (2) Despite subclause (1), subclause (3) applies if—
 - (a) the losing **trader** trades **electricity** at the **ICP** through a **metering installation** with a submission type of non **half hour** in the **registry**; and
 - (b) the gaining **trader** will trade **electricity** at the **ICP** through a **metering installation** with a submission type of **half hour** in the **registry**, as a result of the gaining **trader's** arrangement to trade **electricity** with the customer or the **embedded generator**; and
 - (c) a **switch event meter reading** provided by the losing **trader** under subclause (1) has not been obtained from an **interrogation** of a **certified metering installation** with an AMI flag of Y in the **registry**.
- (3) No later than 5 **business days** after the date on which the **registry manager**, under clause 22(d), makes written notice of switch completion information available to the gaining **trader**—
 - (a) the gaining **trader** may provide the losing **trader** with a **switch event meter reading** obtained from an **interrogation** of a **certified metering installation** with an AMI flag of Y in the **registry**; and
 - (b) the losing **trader** must use that **switch event meter reading**.

Compare: Electricity Governance Rules 2003 clause 1.4 schedule E2

Clause 6: amended on 9 October 2015, by clause 12(1) of the Electricity Industry Participation Code Amendment (ICP Switching) 2014.

Clause 6(a): amended on 9 October 2015, by clause 12(2) of the Electricity Industry Participation Code Amendment (ICP Switching) 2014.

Clause 6(b): substituted on 9 October 2015, by clause 12(3) of the Electricity Industry Participation Code Amendment (ICP Switching) 2014.

Clause 6(2) and (3): inserted on 9 October 2015, by clause 8 of the Electricity Industry Participation Code Amendment (ICP Switching) 2015.

Clause 6(2)(b): amended, on 1 November 2018, by clause 56 of the Electricity Industry Participation Code Amendment (Code Review Programme) 2018.

Clause 6(3): amended, on 5 October 2017, by clause 259 of the Electricity Industry Participation Code Amendment (Code Review Programme) 2017.

Clause 6(3): amended, on 1 March 2022, by clause 41 of the Electricity Industry Participation Code Amendment (Code Review Programme) 2019.

6A Gaining trader disputes reading

- (1) If a gaining **trader** disputes a **switch event meter reading** under clause 6(1)(b), the gaining **trader** must, no later than 4 months after the date on which the **registry manager** made written notice under clause 22(d) of switch completion information

available to the gaining **trader**, provide to the losing **trader** a revised **switch event meter reading** supported by 2 **validated meter readings**.

- (2) On receipt of a revised **switch event meter reading** from the gaining **trader** under subclause (1), the losing **trader** must either,—
- (a) if the losing **trader** accepts the revised **switch event meter reading**, or does not respond to the gaining **trader**, use the revised **switch event meter reading**; or
 - (b) if the losing **trader** does not accept the revised **switch event meter reading**, advise the gaining **trader** (giving all relevant details) no later than 5 **business days** after receiving the revised **switch event meter reading**.

Clause 6A: inserted on 9 October 2015, by clause 13 of the Electricity Industry Participation Code Amendment (ICP Switching) 2014.

Clause 6A Heading: amended on 9 October 2015, by clause 9(a) of the Electricity Industry Participation Code Amendment (ICP Switching) 2015.

Clause 6A: amended on 9 October 2015, by clause 9(b) and (c) of the Electricity Industry Participation Code Amendment (ICP Switching) 2015.

Clause 6A: replaced, on 5 October 2017, by clause 260 of the Electricity Industry Participation Code Amendment (Code Review Programme) 2017.

Clause 6A(1): amended, on 1 February 2019, by clause 57 of the Electricity Industry Participation Code Amendment (Code Review Programme) 2018.

Clause 6A(1): replaced, on 1 March 2022, by clause 42 of the Electricity Industry Participation Code Amendment (Code Review Programme) 2019.

7 Disputes

- (1) A losing **trader** or a gaining **trader** may give written notice to the other **trader** that it disputes a **switch event meter reading** provided under clauses 1 to 6.
- (2) The dispute must be resolved in accordance with the disputes procedure in clause 15.29 (with all necessary amendments).

Compare: Electricity Governance Rules 2003 clause 1.5 schedule E2

Clause 7(1): amended on 9 October 2015, by clause 14 of the Electricity Industry Participation Code Amendment (ICP Switching) 2014.

Clause 7(1): amended, on 5 October 2017, by clause 261 of the Electricity Industry Participation Code Amendment (Code Review Programme) 2017.

Switch move process

8 Switch move process for ICPs

- (1) A standard switch process applies only when a **trader** (the “gaining **trader**”) has an arrangement with a customer or **embedded generator** to commence trading **electricity** with the customer or **embedded generator** at, or to otherwise assume responsibility under clause 11.18(1) for, an **ICP** for which no **trader** has an agreement to trade **electricity** and the gaining **trader** switch process under clauses 13 to 16 does not apply.
- (1A) This clause and clauses 9 to 12 apply to a switch move process.
- (2) If subpart 2 of Part 4A of the Fair Trading Act 1986 applies to an arrangement described in subclause (1)—
 - (a) the gaining **trader** must identify the period within which the customer or **embedded generator** may cancel the arrangement in accordance with section 36M of the Fair Trading Act 1986; and
 - (b) for the purpose of this Schedule, the arrangement is deemed to come into effect on the day after the expiry of the period.

Compare: Electricity Governance Rules 2003 clauses 2.1A and 2.1B schedule E2

Clause 8 Heading: amended, on 29 August 2013, by clause 12(1) of the Electricity Industry Participation (Metering Arrangements) Code Amendment 2013.

Clause 8(1) and 8(1A): substituted on 9 October 2015, by clause 15 of the Electricity Industry Participation Code Amendment (ICP Switching) 2014.

Clause 8(1)(a): substituted, on 29 August 2013, by clause 12(2) of the Electricity Industry Participation (Metering Arrangements) Code Amendment 2013.

Clause 8(1): amended, on 1 November 2018, by clause 58(1) and (2) of the Electricity Industry Participation Code Amendment (Code Review Programme) 2018.

Clause 8(2): amended, on 6 November 2014, by clause 15(2) of the Electricity Industry Participation Code Amendment (ICP Switching) 2014.

Clause 8(2)(a): amended, on 6 November 2014, by clause 15(3) of the Electricity Industry Participation Code Amendment (ICP Switching) 2014.

Clause 8(2)(a): amended, on 1 November 2018, by clause 58(2) of the Electricity Industry Participation Code Amendment (Code Review Programme) 2018.

9 Gaining trader informs registry manager of switch request

- (1) For each **ICP** to which a switch relates, the gaining **trader** must advise the **registry manager** of the switch request no later than **2 business days** after the arrangement to trade **electricity** with the customer or the **embedded generator** comes into effect.
- (2) The gaining **trader** must include in its advice to the **registry manager**—
 - (a) a proposed **event date**; and
 - (b) that the switch type is **MI**; and
 - (c) **1 or more profile codes** of a **profile** at the **ICP**.

Compare: Electricity Governance Rules 2003 clause 2.1 schedule E2

Clause 9 Heading: amended, on 5 October 2017, by clause 262(1) of the Electricity Industry Participation Code Amendment (Code Review Programme) 2017.

Clause 9(1): amended, on 9 October 2015, by clause 16(1)(a) and 16(1)(b) of the Electricity Industry Participation Code Amendment (ICP Switching) 2014.

Clause 9(1): amended, on 1 November 2018, by clause 59 of the Electricity Industry Participation Code Amendment (Code Review Programme) 2018.

Clause 9(2): inserted, on 9 October 2015, by clause 16(2) of the Electricity Industry Participation Code Amendment (ICP Switching) 2014.

Clause 9(1) and (2): amended, on 5 October 2017, by clause 262(2) of the Electricity Industry Participation Code Amendment (Code Review Programme) 2017.

10 Losing trader response to switch move request

- (1) The **trader** that is recorded in the **registry** as being responsible for an **ICP** that is subject to a switch request (the “losing **trader**”) must, no later than **5 business days** after the date on which the **registry manager** makes written notice under clause 22(a) of the switch request available to the losing **trader**,—
 - (a) if the losing **trader** accepts the event date proposed by the gaining **trader**, complete the switch by providing to the **registry manager**—
 - (i) *[Revoked]*
 - (ia) confirmation of the **event date**; and
 - (ib) a valid switch response code approved by the **Authority**; and
 - (ii) final information in accordance with clause 11; or
 - (b) if the losing **trader** does not accept the **event date** proposed by the gaining **trader**, acknowledge the switch request to the **registry manager** and determine a different **event date** that—
 - (i) is not earlier than the gaining **trader’s** proposed **event date**; and

- (ii) is no later than 10 **business days** after the date on which the **registry manager**, under clause 22(a), made written notice of the switch request available to the losing **trader**; or
 - (c) request that the switch be withdrawn in accordance with clause 17.
- (2) If the losing **trader** determines a different **event date** under subclause (1)(b), the losing **trader** must, no later than 10 **business days** after the date on which the **registry manager** made written notice referred to in subclause (1) available to the losing **trader**, also complete the switch by providing to the **registry manager** the information described in subclause (1)(a), but in that case the **event date** is the **event date** determined by the losing **trader**.

Compare: Electricity Governance Rules 2003 clause 2.2 schedule E2

Clause 10: substituted, on 9 October 2015, by clause 17 of the Electricity Industry Participation Code Amendment (ICP Switching) 2014.

Clause 10(1): amended, on 9 October 2015, by clause 10(1) of the Electricity Industry Participation Code Amendment (ICP Switching) 2015.

Clause 10(1): amended, on 5 October 2017, by clause 263(1), (2) and (3) of the Electricity Industry Participation Code Amendment (Code Review Programme) 2017.

Clause 10(1)(a)(i): revoked, on 9 October 2015, by clause 10(2)(a) of the Electricity Industry Participation Code Amendment (ICP Switching) 2015.

Clause 10(1)(a)(ia) and (ib): inserted, on 9 October 2015, by clause 10(2)(b) of the Electricity Industry Participation Code Amendment (ICP Switching) 2015.

Clause 10(1)(b): amended, on 9 October 2015, by clause 10(3) of the Electricity Industry Participation Code Amendment (ICP Switching) 2015.

Clause 10(1)(c): amended, on 9 October 2015, by clause 10(4) of the Electricity Industry Participation Code Amendment (ICP Switching) 2015.

Clause 10(2): amended, on 5 October 2017, by clause 263(2) of the Electricity Industry Participation Code Amendment (Code Review Programme) 2017.

Clause 10(2): amended, on 1 November 2018, by clause 60 of the Electricity Industry Participation Code Amendment (Code Review Programme) 2018.

Clause 10: replaced, on 1 March 2022, by clause 43 of the Electricity Industry Participation Code Amendment (Code Review Programme) 2019.

11 Losing trader must provide final information

The losing **trader** must provide final information to the **registry manager** for the purposes of clause 10(1)(a)(ii), including—

- (a) the **event date**; and
- (b) a **switch event meter reading** as at the **event date** for each **meter** or **data storage device** that is recorded in the **registry** with an accumulator type of C and a settlement indicator of Y; and
- (c) if the **switch event meter reading** is not a **validated meter reading**, the date of the last **meter reading** of the **meter** or **data storage device** described in paragraph (b).

Compare: Electricity Governance Rules 2003 clause 2.3 schedule E2

Clause 11: substituted, on 9 October 2015, by clause 17 of the Electricity Industry Participation Code Amendment (ICP Switching) 2014.

Clause 11: amended, on 9 October 2015, by clause 11 of the Electricity Industry Participation Code Amendment (ICP Switching) 2015.

Clause 11: amended, on 5 October 2017, by clause 264 of the Electricity Industry Participation Code Amendment (Code Review Programme) 2017.

12 Gaining trader may change switch event meter reading

- (1) The gaining **trader** may use the **switch event meter reading** supplied by the losing **trader** or may, at its own cost, obtain its own **switch event meter reading**.

- (2) If the gaining **trader** elects to use the new **switch event meter reading**, the gaining **trader** must advise the losing **trader** of the new **switch event meter reading** and the **event date** to which it refers as follows:
- (a) if the **switch event meter reading** established by the gaining **trader** differs by less than 200 kWh from that provided by the losing **trader**, both **traders** must use the **switch event meter reading** provided by the gaining **trader**; or
 - (b) if the **switch event meter reading** provided by the losing **trader** differs by 200 kWh or more from a value established by the gaining **trader**, the gaining **trader** may dispute the **switch event meter reading**.
- (2A) Despite subclauses (1) and (2), subclause (2B) applies if—
- (a) the losing **trader** trades **electricity** at the **ICP** through a **metering installation** with a submission type of non **half hour** in the **registry**; and
 - (b) the gaining **trader** will trade **electricity** at the **ICP** through a **metering installation** with a submission type of **half hour** in the **registry**, as a result of the gaining **trader's** arrangement with the customer or **embedded generator**; and
 - (c) a **switch event meter reading** provided by the losing **trader** under subclause (1) has not been obtained from an **interrogation** of a **certified metering installation** with an AMI flag of Y in the **registry**.
- (2B) No later than 5 **business days** after the date on which the **registry manager**, under clause 22(d), makes written notice,—
- (a) the gaining **trader** may provide the losing **trader** with a **switch event meter reading** obtained from an **interrogation** of a **certified metering installation** with an AMI flag of Y in the **registry**; and
 - (b) the losing **trader** must use that **switch event meter reading**
- (3) If the gaining **trader** disputes a **switch event meter reading** under subclause (2)(b), the gaining **trader** must, no later than 4 months after the date on which the **registry manager**, under clause 22(d), made written notice of switch completion information available to the gaining **trader**, provide to the losing **trader** a revised **validated meter reading** or a **permanent estimate** supported by 2 **validated meter readings**, and the losing **trader** must either,—
- (a) no later than 5 **business days** after receiving the **switch event meter reading** from the gaining **trader**, the losing **trader**, if it does not accept the **switch event meter reading**, must advise the gaining **trader** (giving all relevant details), and the losing **trader** and the gaining **trader** must use reasonable endeavours to resolve the dispute in accordance with the disputes procedure contained in clause 15.29 (with all necessary amendments); or
 - (b) if the losing **trader** advises its acceptance of the **switch event meter reading** received from the gaining **trader**, or does not provide any response, the losing **trader** must use the **switch event meter reading** supplied by the gaining **trader**.

Compare: Electricity Governance Rules 2003 clause 2.4 schedule E2
Clause 12 Heading: amended, on 9 October 2015, by clause 18(1) of the Electricity Industry Participation Code Amendment (ICP Switching) 2014.
Clause 12(1) and (3): amended, on 9 October 2015, by clause 18(2) of the Electricity Industry Participation Code Amendment (ICP Switching) 2014.
Clause 12(2): substituted, on 9 October 2015, by clause 18(3) of the Electricity Industry Participation Code Amendment (ICP Switching) 2014.

Clause 12(2), (2B) and (3): amended, on 5 October 2017, by clause 265 of the Electricity Industry Participation Code Amendment (Code Review Programme) 2017.

Clause 12(2A) and (2B): inserted, on 9 October 2015, by clause 12 of the Electricity Industry Participation Code Amendment (ICP Switching) 2015.

Clause 12(2A)(b): amended, on 1 November 2018, by clause 61(2) of the Electricity Industry Participation Code Amendment (Code Review Programme) 2018.

Clause 12(2B): amended, on 1 March 2022, by clause 44(1)(a) and (b) of the Electricity Industry Participation Code Amendment (Code Review Programme) 2019.

Clause 12(3): amended, on 9 October 2015, by clause 18(4) of the Electricity Industry Participation Code Amendment (ICP Switching) 2014.

Clause 12(3): amended, on 1 February 2019, by clause 61(1) of the Electricity Industry Participation Code Amendment (Code Review Programme) 2018.

Clause 12(3): amended, on 1 March 2022, by clause 44(2)(a), (b) and (c) of the Electricity Industry Participation Code Amendment (Code Review Programme) 2019.

Clause 12(3)(a): amended, on 9 October 2015, by clause 18(5) of the Electricity Industry Participation Code Amendment (ICP Switching) 2014.

Clause 12(3)(b): amended, on 9 October 2015, by clause 18(6) of the Electricity Industry Participation Code Amendment (ICP Switching) 2014.

Gaining trader switch process

Cross heading: amended, on 9 October 2015, by clause 19 of the Electricity Industry Participation Code Amendment (ICP Switching) 2014.

13 Gaining trader switch processes

- (1) A gaining **trader** switch process applies only when a **trader** (the “gaining **trader**”) has an arrangement with a customer or **embedded generator** to—
- (a) trade **electricity** with the customer or **embedded generator** at an **ICP** at which another **trader** (the “losing **trader**”) trades **electricity** with the customer or **embedded generator**, and one of subparagraphs (i) to (iii) applies—
 - (i) at the **ICP**, the gaining **trader** will trade **electricity** through a **half-hour metering installation** that is a category 3 or higher **metering installation**;
or
 - (ii) at the **ICP**—
 - (A) the gaining **trader** will trade **electricity** through a **half-hour metering installation**, and in the **registry** the **ICP** will have a submission type of **half hour** and an AMI flag of “N”; and
 - (B) the losing **trader** trades **electricity** through a non **half-hour metering installation**, and in the **registry** the **ICP** has a submission type of non **half hour** and an AMI flag of “N”; or
 - (iii) at the **ICP**—
 - (A) the gaining **trader** will trade **electricity** through a non **half-hour metering installation**, and the **ICP** will have a submission type of non **half hour** in the **registry**; and
 - (B) the losing **trader** trades **electricity** through a **half-hour metering installation**, and in the **registry** the **ICP** has a submission type of **half hour** and an AMI flag of “N”; or
 - (b) assume responsibility under clause 11.18(1) for an **ICP** described in subparagraph (a)(i), (a)(ii), or (a)(iii).
- (1A) This clause and clauses 14 to 16 apply to a gaining **trader** switch process.
- (2) If subpart 2 of Part 4A of the Fair Trading Act 1986 applies to an arrangement described in subclause (1)—

- (a) the gaining **trader** must identify the period within which the customer or **embedded generator** may cancel the arrangement in accordance with section 36M of the Fair Trading Act 1986; and
- (b) for the purpose of this Schedule, the arrangement is deemed to come into effect on the day after the expiry of the period.

Compare: Electricity Governance Rules 2003 clauses 3.1 and 3.1A schedule E2

Clause 13 Heading: amended, on 9 October 2015, by clause 20(1) of the Electricity Industry Participation Code Amendment (ICP Switching) 2014.

Clause 13(1): amended, on 9 October 2015, by clause 20(2) of the Electricity Industry Participation Code Amendment (ICP Switching) 2014.

Clause 13(1): amended, on 1 November 2018, by clause 62(1)(a) and (b) of the Electricity Industry Participation Code Amendment (Code Review Programme) 2018.

Clause 13(1)(a): substituted, on 29 August 2013, by clause 13 of the Electricity Industry Participation (Metering Arrangements) Code Amendment 2013.

Clause 13(1)(a): replaced, on 1 February 2019, by clause 62(2) of the Electricity Industry Participation Code Amendment (Code Review Programme) 2018.

Clause 13(1)(a)(i): amended, on 9 October 2015, by clause 13(a) and (b) of the Electricity Industry Participation Code Amendment (ICP Switching) 2015.

Clause 13(1)(a)(i) and (1)(a)(ii): amended, on 5 October 2017, by clause 266 of the Electricity Industry Participation Code Amendment (Code Review Programme) 2017.

Clause 13(1)(b): amended, on 9 October 2015, by clause 20(3) of the Electricity Industry Participation Code Amendment (ICP Switching) 2014.

Clause 13(1)(b): amended, on 1 February 2019, by clause 62(3) of the Electricity Industry Participation Code Amendment (Code Review Programme) 2018.

Clause 13(1A): inserted, on 9 October 2015, by clause 20(4) of the Electricity Industry Participation Code Amendment (ICP Switching) 2014.

Clause 13(2): amended, on 6 November 2014, by clause 20(5) of the Electricity Industry Participation Code Amendment (ICP Switching) 2014.

Clause 13(2)(a): amended, on 6 November 2014, by clause 20(6) of the Electricity Industry Participation Code Amendment (ICP Switching) 2014.

Clause 13(2)(a): amended, on 1 November 2018, by clause 62(4) of the Electricity Industry Participation Code Amendment (Code Review Programme) 2018.

14 Gaining trader informs registry manager of switch request

- (1) For each **ICP** to which a switch relates, the gaining **trader** must advise the **registry manager** of the switch request no later than 3 **business days** after the arrangement to trade **electricity** with the customer or the **embedded generator** comes into effect.
- (2) The gaining **trader** must include in its advice to the **registry manager**—
 - (a) a proposed **event date**; and
 - (b) that the switch type is **HH**.
- (3) Unless subclause (4) applies, the proposed **event date** must be a date that is after the date on which the gaining **trader** advises the **registry manager**.
- (4) The proposed **event date** may be a date that is before the date on which the gaining **trader** advises the **registry manager**, if—
 - (a) the proposed **event date** is in the same month as the date on which the gaining **trader** advises the **registry manager**; or
 - (b) the proposed **event date** is no more than 90 days before the date on which the gaining **trader** advises the **registry manager**, and the losing **trader** and gaining **trader** agree on the proposed **event date**.

Compare: Electricity Governance Rules 2003 clause 3.2 schedule E2

Clause 14 Heading: amended, on 5 October 2017, by clause 267(1) of the Electricity Industry Participation Code Amendment (Code Review Programme) 2017.

Clause 14: amended, on 5 October 2017, by clause 267(2) of the Electricity Industry Participation Code Amendment (Code Review Programme) 2017.
Clause 14(1): amended, on 1 November 2018, by clause 63 of the Electricity Industry Participation Code Amendment (Code Review Programme) 2018.
Clause 14(1): amended, on 9 October 2015, by clause 21(1) of the Electricity Industry Participation Code Amendment (ICP Switching) 2014.
Clause 14(2), (3), and (4): inserted, on 9 October 2015, by clause 21(2) of the Electricity Industry Participation Code Amendment (ICP Switching) 2014.

15 Losing trader provides information

No later than 3 **business days** after the date on which the **registry manager**, under clause 22(a), makes written notice available to the losing **trader**, must—

- (a) provide the **registry manager** with a valid switch response code approved by the **Authority**; or
- (b) request that the switch be withdrawn in accordance with clause 17.

Compare: Electricity Governance Rules 2003 clause 3.3 schedule E2
Clause 15: amended, on 9 October 2015, by clause 22(1) of the Electricity Industry Participation Code Amendment (ICP Switching) 2014.
Clause 15: amended, on 9 October 2015, by clause 14 of the Electricity Industry Participation Code Amendment (ICP Switching) 2015.
Clause 15: amended, on 5 October 2017, by clause 268 of the Electricity Industry Participation Code Amendment (Code Review Programme) 2017.
Clause 15: amended, on 1 March 2022, by clause 45(1) and (2) of the Electricity Industry Participation Code Amendment (Code Review Programme) 2019.
Clause 15(a): amended, on 9 October 2015, by clause 22(2) of the Electricity Industry Participation Code Amendment (ICP Switching) 2014.
Clause 15(b): amended, on 9 October 2015, by clause 22(3) of the Electricity Industry Participation Code Amendment (ICP Switching) 2014.

16 Gaining trader obligations

- (1) The gaining **trader** must complete the switch by advising the **registry manager** of the **event date** no later than 3 **business days** after the date on which the **registry manager**, under clause 22(c), makes written notice of a valid switch response code available to the gaining **trader**.
- (2) If the **ICP** is being **electrically disconnected** or if **metering** equipment is being removed, the gaining **trader** must either—
 - (a) give the losing **trader** or the **metering equipment provider** for the **ICP** an opportunity to **interrogate** the **metering installation** immediately before the **ICP** is **electrically disconnected** or the **metering** equipment is removed; or
 - (b) carry out an **interrogation** and, no later than 5 **business days** after the **metering installation** is **electrically disconnected** or removed, advise the losing **trader** of—
 - (i) the results of the **interrogation**; and
 - (ii) the **metering component** numbers for each data channel in the **metering installation**.

Compare: Electricity Governance Rules 2003 clause 3.4 schedule E2
Clause 16 Heading: amended, on 9 October 2015, by clause 23(1) of the Electricity Industry Participation Code Amendment (ICP Switching) 2014.
Clause 16(1): amended, on 9 October 2015, by clause 23(2) of the Electricity Industry Participation Code Amendment (ICP Switching) 2014.
Clause 16(1): amended, on 9 October 2015, by clause 15 of the Electricity Industry Participation Code Amendment (ICP Switching) 2015.

Clause 16(1): amended, on 1 March 2022, by clause 46(a) and (b) of the Electricity Industry Participation Code Amendment (Code Review Programme) 2019.

Clause 16(1) and (2): amended, on 5 October 2017, by clause 269 of the Electricity Industry Participation Code Amendment (Code Review Programme) 2017.

Clause 16(2): inserted, on 9 October 2015, by clause 23(3) of the Electricity Industry Participation Code Amendment (ICP Switching) 2014.

Withdrawing a switch request

17 Withdrawal of switch requests

A losing **trader** or gaining **trader** may request that a switch request be withdrawn at any time until the expiry of 2 months after the **event date**.

Compare: Electricity Governance Rules 2003 clause 3A schedule E2

Clause 17: amended, on 9 October 2015, by clause 24 of the Electricity Industry Participation Code Amendment (ICP Switching) 2014.

18 Withdrawing a switch request

If a **trader** requests the withdrawal of a switch under clause 17, the following provisions apply:

- (a) the **Authority** must determine the valid codes for withdrawing a switch request (“withdrawal advisory codes”);
- (b) the **Authority** must **publish** the withdrawal advisory codes;
- (c) for each **ICP**, the **trader** withdrawing the switch request must provide the **registry manager** with the following information:
 - (i) the **participant identifier** of the **trader**; and
 - (ii) the withdrawal advisory code **published** by the **Authority** in accordance with paragraph (b);
- (d) no later than 5 **business days** after the date on which the **registry manager**, under clause 22(b), makes written notice available to the **trader** receiving the withdrawal, the **trader** must advise the **registry manager** that the switch withdrawal request is accepted or rejected. A switch withdrawal request must not become effective until accepted by the **trader** who received the withdrawal;
- (e) on receipt of a rejection notice from the **registry manager** in accordance with paragraph (d), a **trader** may re-submit a switch withdrawal request for an **ICP** in accordance with paragraph (c). All switch withdrawal requests must be resolved no later than 10 **business days** after the date of the initial switch withdrawal request;
- (f) if a **trader** requests that a switch request be withdrawn and the resolution of that switch withdrawal request results in the switch proceeding, no later than 2 **business days** after the date on which the **registry manager**, under clause 22(b), makes written notice available to the losing **trader**, the losing **trader** must comply with clauses 3, 5, 10 and 11 (whichever is appropriate) and the gaining **trader** must comply with clause 16.

Compare: Electricity Governance Rules 2003 clause 4 schedule E2

Clause 18(b): amended, on 21 September 2012, by clause 16(1) of the Electricity Industry Participation (Minor Amendments) Code Amendment 2012.

Clause 18(c)(i): amended, on 21 September 2012, by clause 16(2) of the Electricity Industry Participation (Minor Amendments) Code Amendment 2012.

Clause 18(c) to (f): amended, on 5 October 2017, by clause 270 of the Electricity Industry Participation Code Amendment (Code Review Programme) 2017.

Clause 18(d): amended, on 1 March 2022, by clause 47(1) of the Electricity Industry Participation Code Amendment (Code Review Programme) 2019.

Clause 18(d), (e), and (f): amended, on 9 October 2015, by clause 25 of the Electricity Industry Participation Code Amendment (ICP Switching) 2014.

Clause 18(f): amended, on 1 March 2022, by clause 47(2) of the Electricity Industry Participation Code Amendment (Code Review Programme) 2019.

Exchange of information

19 Participants to use file formats

Participants who exchange information in accordance with this Schedule must use the file formats determined and **published** by the **Authority**.

Compare: Electricity Governance Rules 2003 clause 5.1 schedule E2

20 Method of exchanging files

(1) The **Authority** may, from time to time, after consultation with **participants**, do all or any of the following:

- (a) determine the method by which **participants** exchange information:
- (b) determine the file formats that **participants** must use to exchange information:
- (c) alter the file formats or the method by which **participants** exchange information.

(2) The **Authority** must **publish** the file formats.

Compare: Electricity Governance Rules 2003 clause 5.2 schedule E2

Clause 20(1): substituted, on 15 May 2014, by clause 30 of the Electricity Industry Participation (Minor Code Amendments) Code Amendment 2014.

21 Metering information

For each **interrogation** or **switch event meter reading** carried out in accordance with this Schedule,—

- (a) the **trader** who carries out the **interrogation** or **switch event meter reading** must ensure that the **interrogation** is as accurate as possible, or that the **switch event meter reading** is fair and reasonable (as the case may be); and
- (b) the cost of each **interrogation** or **switch event meter reading** must be met as follows:
 - (i) for each **interrogation** or **switch event meter reading** carried out in accordance with clauses 5(b) or 11(b) or (c), the cost must be met by the losing **trader**; and
 - (ii) in every other case, the cost must be met by the gaining **trader**.

Compare: Electricity Governance Rules 2003 clause 5.3 schedule E2

Clause 21: amended, on 9 October 2015, by clause 26(1) of the Electricity Industry Participation Code Amendment (ICP Switching) 2014.

Clause 21(a): amended, on 9 October 2015, by clause 26(2) of the Electricity Industry Participation Code Amendment (ICP Switching) 2014.

Clause 21(b), and (c): substituted, on 9 October 2015, by clause 26(3) of the Electricity Industry Participation Code Amendment (ICP Switching) 2014.

22 Registry manager notices

The **registry manager** must provide notice to **participants** required by this Schedule as follows:

- (a) on receipt of information about a switch request in accordance with clauses 2, 9 and 14, the **registry manager** must make written notice available to the losing **trader** of the information received:
- (b) on receipt of information about a withdrawal request in accordance with clauses 18(c) and (d), the **registry manager** must make written notice available to the other relevant **trader** of the information received:
- (c) on receipt of information about a switch acknowledgement in accordance with clauses 3(a) and 15, the **registry manager** must make written notice available to the gaining **trader** of the information received:
- (d) on receipt of information about a switch completion in accordance with clauses 3(a)(ii), 5, 10 and 16, the **registry manager** must make written notice available to the gaining **trader**, the losing **trader**, the **metering equipment provider**, and the relevant **distributor** of the information received.

Compare: Electricity Governance Rules 2003 clause 5.4 schedule E2

Clause 22 Heading: amended, on 5 October 2017, by clause 271(1) of the Electricity Industry Participation Code Amendment (Code Review Programme) 2017.

Clause 22: amended, on 5 October 2017, by clause 271(2) of the Electricity Industry Participation Code Amendment (Code Review Programme) 2017.

Clause 22(a), (b), (c) and (d): amended, on 1 March 2022, by clause 48 of the Electricity Industry Participation Code Amendment (Code Review Programme) 2019.

Clause 22(d): amended, on 29 August 2013, by clause 14 of the Electricity Industry Participation (Metering Arrangements) Code Amendment 2013.

Clause 22(d): amended, on 9 October 2015, by clause 16 of the Electricity Industry Participation Code Amendment (ICP Switching) 2015.

Schedule 11.4

cls 11.8A and 11.15A

Metering equipment provider switching and registry metering records

Schedule 11.4: inserted on 29 August 2013, by clause 22 of the Electricity Industry Participation (Metering Arrangements) Code Amendment 2011.

1 Metering equipment provider receives notice for ICP identifier

- (1) Within 10 **business days** of being advised by the **registry manager** under clause 11.18A, a **gaining metering equipment provider**,—
 - (a) must, if it intends to accept responsibility for each **metering installation** for the **ICP**—
 - (i) enter into an arrangement with the **trader**; and
 - (ii) advise the **registry manager** in the **prescribed form** that it accepts responsibility for each **metering installation** for the **ICP** and of the proposed date on which the **metering equipment provider** will assume responsibility for each **metering installation** for the **ICP**; or
 - (b) may, if it intends to decline responsibility for each **metering installation** for the **ICP**, advise the **registry manager** in the **prescribed form** that it declines to accept responsibility for each **metering installation** for the **ICP**.
- (2) The **registry manager** must, within 1 **business day** of a **metering equipment provider** advising under subclause (1)(b) that it declines to accept responsibility for each **metering installation** for the **ICP**, advise the **trader** of the declinature.
- (3) The **registry manager** must, within 1 **business day** of a **gaining metering equipment provider** advising of acceptance under subclause (1)(a), advise the following **participants** for the **ICP** of the acceptance and proposed date on which the **gaining metering equipment provider** will assume responsibility for each **metering installation** for the **ICP**:
 - (a) the **trader**; and
 - (b) the **distributor**; and
 - (c) if relevant, the **losing metering equipment provider**.

Clause 1 Heading: amended, on 5 October 2017, by clause 272(1) of the Electricity Industry Participation Code Amendment (Code Review Programme) 2017.

Clause 1: amended, on 5 October 2017, by clause 272(2) of the Electricity Industry Participation Code Amendment (Code Review Programme) 2017.

Clause 1(1): amended, on 29 August 2013, by clause 49 of the Electricity Industry Participation (Metering Arrangements) Code Amendment 2011, Amendment 2013 (No 2).

Clause 1(1)(b): amended, on 1 November 2018, by clause 64 of the Electricity Industry Participation Code Amendment (Code Review Programme) 2018.

2 Gaining metering equipment provider to advise registry manager of registry metering records

If the **metering equipment provider** who is responsible for a **metering installation** for an **ICP** changes, the **metering equipment provider** must, within 15 **business days** of becoming the **metering equipment provider** for the **metering installation**, advise the **registry manager** of the **registry metering records** for the **metering installation**.

Clause 2 Heading: amended, on 5 October 2017, by clause 273(1) of the Electricity Industry Participation Code Amendment (Code Review Programme) 2017.

Clause 2: amended, on 5 October 2017, by clause 273(2) of the Electricity Industry Participation Code Amendment (Code Review Programme) 2017.

3 Metering equipment provider to advise registry manager of changes to registry metering records

If a **metering equipment provider** has an arrangement with a **trader** at an **ICP** that is not also an **NSP**, the **metering equipment provider** must advise the **registry manager** of the **registry metering records**, or any change to the **registry metering records**, for each **metering installation** for which it is responsible at the **ICP**, no later than—

- (a) *[Revoked]*
- (b) *[Revoked]*
- (c) if updating the **registry metering records** in accordance with clause 8(11)(b) of Schedule 10.6, 10 **business days** following the most recent unsuccessful **interrogation**; or
- (d) if updating the **registry metering records** in accordance with clause 8(13) of Schedule 10.6, 3 **business days** following—
 - (i) the expiry of the time period under clause 8(12) of Schedule 10.6; or
 - (ii) the date on which the **metering equipment provider** determines in an investigation under clause 8(11)(a) of Schedule 10.6 that it cannot restore communications or fully download the **raw meter data**; or
- (e) in all other cases, 10 **business days** following:
 - (i) the **electrical connection** of an **ICP** that is not also an **NSP**; or
 - (ii) any subsequent change in any matter covered by the **metering records** other than a change to which subparagraphs (c) and (d) apply.

Clause 3 Heading: amended, on 5 October 2017, by clause 274(1) of the Electricity Industry Participation Code Amendment (Code Review Programme) 2017.

Clause 3: amended, on 5 October 2017, by clause 274(2) of the Electricity Industry Participation Code Amendment (Code Review Programme) 2017.

Clause 3 amended, on 1 November 2018, by clause 65(a), (b) and (c) of the Electricity Industry Participation Code Amendment (Code Review Programme) 2018.

Clause 3 amended, on 1 February 2021, by clause 46(1) of the Electricity Industry Participation Code Amendment (Metering and Related Registry Processes) 2020.

Clause 3(a): amended, on 29 August 2013, by clause 50 of the Electricity Industry Participation (Metering Arrangements) Code Amendment 2011, Amendment 2013 (No 2).

Clause 3(a): amended, on 1 November 2018, by clause 65(d) of the Electricity Industry Participation Code Amendment (Code Review Programme) 2018.

Clause 3(a) revoked, on 1 February 2021, by clause 46(2) of the Electricity Industry Participation Code Amendment (Metering and Related Registry Processes) 2020.

Clause 3(b): amended, on 1 November 2018, by clause 65(e) of the Electricity Industry Participation Code Amendment (Code Review Programme) 2018.

Clause 3(b) revoked, on 1 February 2021, by clause 46(2) of the Electricity Industry Participation Code Amendment (Metering and Related Registry Processes) 2020.

Clause 3(c), (d) and (e) inserted, on 1 February 2021, by clause 46(3) of the Electricity Industry Participation Code Amendment (Metering and Related Registry Processes) 2020.

4 Registry manager requirement to advise

The **registry manager** must, within 1 **business day** of being advised—

- (a) under clauses 2 or 3, advise the **trader** and **distributor** of the **registry metering records**;
- (b) under clauses 3 or 6, advise—

- (i) the **trader and distributor** of the details of the change to the **registry metering records**; and
- (ii) the **losing metering equipment provider** of the date of change of the **metering equipment provider for the ICP identifier**.

Clause 4 Heading: amended, on 5 October 2017, by clause 275(1) of the Electricity Industry Participation Code Amendment (Code Review Programme) 2017.

Clause 4: amended, on 5 October 2017, by clause 275(2) of the Electricity Industry Participation Code Amendment (Code Review Programme) 2017.

5 Changes to registry metering records for ICP identifier

The **registry manager** must, within 1 **business day** of being advised of 1 or more of the following changes relating to an **ICP identifier** record, advise the **metering equipment provider** of the change:

- (a) the **trader participant identifier**;
- (b) the **distributor participant identifier**;
- (c) the settlement type;
- (d) the status of the **ICP**.

Clause 5 Heading: amended, on 5 October 2017, by clause 276(1) of the Electricity Industry Participation Code Amendment (Code Review Programme) 2017.

Clause 5: amended, on 5 October 2017, by clause 276(2) of the Electricity Industry Participation Code Amendment (Code Review Programme) 2017.

6 Correction of errors in registry

- (1) A **metering equipment provider** must, by 0900 hours on the 13th **business day** of each **reconciliation period**, obtain the following information from the **registry**:
 - (a) a list of the **ICP identifiers** for the **ICPs** for the **metering installations** for which the **metering equipment provider** is recorded in the **registry** as being responsible; and
 - (b) the **registry metering records** for each **ICP identifier** obtained under paragraph (a).
- (2) A **metering equipment provider** must, as soon as reasonably practicable but not later than 5 **business days** after it obtains the information under subclause (1), compare the information obtained with its own records.
- (3) If the **metering equipment provider** finds a discrepancy between the information obtained under subclause (1) and its own records, the **metering equipment provider** must, within 5 **business days** of becoming aware of the discrepancy,—
 - (a) correct its records that are in error; and
 - (b) advise the **registry manager** of any necessary changes to the **registry metering records**.

Clause 6(3)(b): amended, on 5 October 2017, by clause 277 of the Electricity Industry Participation Code Amendment (Code Review Programme) 2017.

Clause 6(3)(b): amended, on 1 November 2018, by clause 66 of the Electricity Industry Participation Code Amendment (Code Review Programme) 2018.

7 Metering equipment provider to provide registry metering records to registry manager

- (1) A **metering equipment provider** must, if required under this Part, provide to the **registry manager** the information indicated in Table 1 as being "Required", in the **prescribed form**, for each **metering installation** for which it is responsible.
- (1A) Despite subclause (1) a **metering equipment provider** is not required to provide to the **registry manager** the information indicated in rows 23 to 30 of Table 1 as being "Required", if the information is used only for the purpose of a **distributor** direct billing **consumers** on its **network**.

Clause 7(1A) inserted, on 1 February 2021, by clause 47 of the Electricity Industry Participation Code Amendment (Metering and Related Registry Processes) 2020.

- (2) Despite anything to the contrary in this Code (except clause 11.2) the **metering equipment provider** must—
- (a) provide the information set out in Table 1 indicated as being required for **interim certified metering installations** to the **registry manager** for all **category 1 metering installations** for which it is responsible; and
 - (b) ensure that the **registry metering records** provided in accordance with this clause are, for not less than 50% of the **category 1 metering installations** for which it is responsible, complete, accurate, not misleading or deceptive, and not likely to mislead or deceive, by no later than 1 October 2014; and
 - (c) ensure that the **registry metering records** provided in accordance with this clause are, for each **category 1 metering installation** for which it is responsible, complete, accurate, not misleading or deceptive, and not likely to mislead or deceive, by no later than 1 April 2015.
- (3) The **metering equipment provider** must derive the information provided under subclause (2)(a) from—
- (a) the **metering equipment provider's metering records**; or
 - (b) the **metering records** contained within the current **trader's** system.

Clause 7 Heading: amended, on 5 October 2017, by clause 278(1) of the Electricity Industry Participation Code Amendment (Code Review Programme) 2017.

Clause 7(1) and 2(a): amended, on 5 October 2017, by clause 278(2) of the Electricity Industry Participation Code Amendment (Code Review Programme) 2017.

Clause 7(2): amended, on 29 August 2013, by clause 51 of the Electricity Industry Participation (Metering Arrangements) Code Amendment 2011, Amendment 2013 (No 2).

Table 1: Registry metering records

The following table sets out the **registry metering records**:

No	Registry term	Description	Fully certified metering installation	Interim certified metering installation
For each ICP identifier				
1	the metering equipment provider participant identifier	participant identifier	Required	Required
For each metering installation for an ICP				
2	metering installation number	a sequential number that is unique to the ICP's identifier , to identify the metering installation	Required	Required
3	highest metering category	the category recorded in the metering installation certification report	Required	Required
4	metering installation location code	a code from the list of codes in the registry , that identifies the location of the metering installation on a premises	Required	Required
5	the ATH participant identifier	the participant identifier of the ATH who certified the metering installation	Required	Optional

No	Registry term	Description	Fully certified metering installation	Interim certified metering installation
6	metering installation certification type	the certification type of the metering installation which must be half hour or non half hour as identified in the metering installation certification report or, where both half hour and non half hour are specified as the certification type in the metering installation certification report , must be one of those certification types .	Required	Required
7	metering installation certification date	the effective certification date identified in the metering installation certification report	Required	Optional

Electricity Industry Participation Code 2010
Schedule 11.4

No	Registry term	Description	Fully certified metering installation	Interim certified metering installation
8	the metering installation certification expiry date	the metering installation certification expiry date, identified in the metering installation certification report , or the date that the metering installation certification is cancelled	Required	Required
9	control device certification	confirmation that the control device used in the metering installation is included in the metering installation certification report	Required	Optional

No	Registry term	Description	Fully certified metering installation	Interim certified metering installation
10	certification variations	(a) Does an exemption under the Act for the metering installation apply? (b) Has the alternate measuring transformer certification process been used?	Required	Optional
11	certification variations expiry date	the earlier of the expiry date of any certification variation under item 10	Required	Optional
12	certification number	the certification number assigned to a metering installation's certification	Required	Optional
13	maximum interrogation cycle	the maximum interrogation cycle for the metering installation included in its certification report	Required	Required

No	Registry term	Description	Fully certified metering installation	Interim certified metering installation
14	price code	if the metering equipment provider considers it relevant, an identifier that may be used to indicate the price that would apply to a lease for the use of the metering installation	Optional	Optional
The following details for each metering component in the metering installation for each ICP				
15	metering component type	an identifier used to identify the type of metering component in the metering installation selected from the list of codes in the registry	Required	Required
16	metering component identifier	an identifier visible on the installed metering component that is either the manufacturer's serial number or the owner's component asset number	Required	Required for meter or data storage device . Optional for all other metering components .

No	Registry term	Description	Fully certified metering installation	Interim certified metering installation
17	meter or data storage device type	an identifier used to identify the type of meter or data storage device in the metering installation , which may be half hour , non half hour , or prepay selected from the list of codes in the registry	Required for meter or data storage device .	Required for meter or data storage device .
18	AMI type	an identifier to identify if the metering component is an advanced metering infrastructure device and the metering equipment provider's back office is the services access interface	Required for meter or data storage device . Optional for all other metering components .	Required for meter or data storage device . Optional for all other metering components .
19	registry compensation factor	the mathematical product of all compensation factors that the trader must apply to transform the raw meter data into volume information	Required for meter or data storage device . Optional for all other metering components .	Required for meter or data storage device . Optional for all other metering components .

No	Registry term	Description	Fully certified metering installation	Interim certified metering installation
20	owner of a metering component	a free text field to identify the owner of a metering component , which may be a participant identifier if the owner is a participant	Optional	Optional
21	removal date of a meter or data storage device	a date that a meter or data storage device is removed	Optional for meter or data storage device	Optional for meter or data storage device
The following details for each metering component identified in rows 15 to 21 above				
22	metering component type	the metering component type identifier selected from the list of codes in the registry	Required for meter or data storage device that returns any 1 or more of the following values as a result of an interrogation : (a) active energy : (b) reactive energy : (c) apparent energy : (d) apparent power . Optional for all other metering components .	Required for meter or data storage device that returns any 1 or more of the following values as a result of an interrogation : (a) active energy : (b) reactive energy : (c) apparent energy : (d) apparent power . Optional for all other metering components .

Electricity Industry Participation Code 2010
Schedule 11.4

No	Registry term	Description	Fully certified metering installation	Interim certified metering installation
23	register number	a sequential number that identifies each data channel that is present in the metering component	<p>Required (except where clause 7(1A) of this Schedule applies) for meter or data storage device that returns any 1 or more of the following values as a result of an interrogation:</p> <ul style="list-style-type: none"> (a) active energy: (b) reactive energy: (c) apparent energy: (d) apparent power. <p>Optional for all other metering components.</p>	<p>Required (except where clause 7(1A) of this Schedule applies) for meter or data storage device that returns any 1 or more of the following values as a result of an interrogation:</p> <ul style="list-style-type: none"> (a) active energy: (b) reactive energy: (c) apparent energy: (d) apparent power. <p>Optional for all other metering components.</p>

Electricity Industry Participation Code 2010
Schedule 11.4

No	Registry term	Description	Fully certified metering installation	Interim certified metering installation
24	number of dials	the number of dials or digits that relate to the data channel	<p>Required (except where clause 7(1A) of this Schedule applies) for meter or data storage device that returns any 1 or more of the following values as a result of an interrogation:</p> <ul style="list-style-type: none"> (a) active energy: (b) reactive energy: (c) apparent energy: (d) apparent power. <p>Optional for all other metering components.</p>	<p>Required (except where clause 7(1A) of this Schedule applies) for meter or data storage device that returns any 1 or more of the following values as a result of an interrogation:</p> <ul style="list-style-type: none"> (a) active energy: (b) reactive energy: (c) apparent energy: (d) apparent power. <p>Optional for all other metering components.</p>

Electricity Industry Participation Code 2010
Schedule 11.4

No	Registry term	Description	Fully certified metering installation	Interim certified metering installation
25	register content code	an identifier for the contents of a channel or a data channel, selected from a list in the registry	<p>Required (except where clause 7(1A) of this Schedule applies) for meter or data storage device that returns any 1 or more of the following values as a result of an interrogation:</p> <ul style="list-style-type: none"> (a) active energy: (b) reactive energy: (c) apparent energy: (d) apparent power. <p>Optional for all other metering components.</p>	<p>Required (except where clause 7(1A) of this Schedule applies) for meter or data storage device that returns any 1 or more of the following values as a result of an interrogation:</p> <ul style="list-style-type: none"> (a) active energy: (b) reactive energy: (c) apparent energy: (d) apparent power. <p>Optional for all other metering components.</p>

Electricity Industry Participation Code 2010
Schedule 11.4

No	Registry term	Description	Fully certified metering installation	Interim certified metering installation
26	period of availability	an identifier for the period of availability for which a control device is configured, selected from a list in the registry	<p>Required (except where clause 7(1A) of this Schedule applies) for meter or data storage device that returns any 1 or more of the following values as a result of an interrogation:</p> <ul style="list-style-type: none"> (a) active energy: (b) reactive energy: (c) apparent energy: (d) apparent power. <p>Optional for all other metering components.</p>	<p>Required (except where clause 7(1A) of this Schedule applies) for meter or data storage device that returns any 1 or more of the following values as a result of an interrogation:</p> <ul style="list-style-type: none"> (a) active energy: (b) reactive energy: (c) apparent energy: (d) apparent power. <p>Optional for all other metering components.</p>

Electricity Industry Participation Code 2010
Schedule 11.4

No	Registry term	Description	Fully certified metering installation	Interim certified metering installation
27	unit of measurement	an identifier for the units recorded in a data channel, selected from a list in the registry	<p>Required (except where clause 7(1A) of this Schedule applies) for meter or data storage device that returns any 1 or more of the following values as a result of an interrogation:</p> <ul style="list-style-type: none"> (a) active energy: (b) reactive energy: (c) apparent energy: (d) apparent power. <p>Optional for all other metering components.</p>	<p>Required (except where clause 7(1A) of this Schedule applies) for meter or data storage device that returns any 1 or more of the following values as a result of an interrogation:</p> <ul style="list-style-type: none"> (a) active energy: (b) reactive energy: (c) apparent energy: (d) apparent power. <p>Optional for all other metering components.</p>

Electricity Industry Participation Code 2010
Schedule 11.4

No	Registry term	Description	Fully certified metering installation	Interim certified metering installation
28	energy flow direction	an identifier for the import or export recording in the data channel, selected from a list in the registry	<p>Required (except where clause 7(1A) of this Schedule applies) for meter or data storage device that returns any 1 or more of the following values as a result of an interrogation:</p> <ul style="list-style-type: none"> (a) active energy: (b) reactive energy: (c) apparent energy: (d) apparent power. <p>Optional for all other metering components.</p>	<p>Required (except where clause 7(1A) of this Schedule applies) for meter or data storage device that returns any 1 or more of the following values as a result of an interrogation:</p> <ul style="list-style-type: none"> (a) active energy: (b) reactive energy: (c) apparent energy: (d) apparent power. <p>Optional for all other metering components.</p>

Electricity Industry Participation Code 2010
Schedule 11.4

No	Registry term	Description	Fully certified metering installation	Interim certified metering installation
29	accumulator type	an identifier for either absolute or cumulative recording in the data channel, selected from a list in the registry	<p>Required (except where clause 7(1A) of this Schedule applies) for meter or data storage device that returns any 1 or more of the following values as a result of an interrogation:</p> <ul style="list-style-type: none"> (a) active energy: (b) reactive energy: (c) apparent energy: (d) apparent power. <p>Optional for all other metering components.</p>	<p>Required (except where clause 7(1A) of this Schedule applies) for meter or data storage device that returns any 1 or more of the following values as a result of an interrogation:</p> <ul style="list-style-type: none"> (a) active energy: (b) reactive energy: (c) apparent energy: (d) apparent power. <p>Optional for all other metering components.</p>

No	Registry term	Description	Fully certified metering installation	Interim certified metering installation
30	settlement indicator	<p>an identifier determined as follows:</p> <p>(a) if the relevant meter or data storage device has an AMI flag of "Y", the cumulative data channel identifier must be "Y" and the other data channel identifiers must be "N"; and</p> <p>(b) for any other meter or data storage device, or for a control device, the data channel identifier must be the appropriate identifier selected from the list in the registry</p>	<p>Required (except where clause 7(1A) of this Schedule applies) for meter or data storage device that returns any 1 or more of the following values as a result of an interrogation:</p> <p>(a) active energy;</p> <p>(b) reactive energy;</p> <p>(c) apparent energy;</p> <p>(d) apparent power.</p> <p>Optional for all other metering components.</p>	<p>Required (except where clause 7(1A) of this Schedule applies) for meter or data storage device that returns any 1 or more of the following values as a result of an interrogation:</p> <p>(a) active energy;</p> <p>(b) reactive energy;</p> <p>(c) apparent energy;</p> <p>(d) apparent power.</p> <p>Optional for all other metering components.</p>
31	event reading	the event meter read of a meter or data storage device	Optional	Optional

Table 1: row 6, column 2 amended, on 5 October 2017, by clause 279(a) of the Electricity Industry Participation Code Amendment (Code Review Programme) 2017.

Table 1: row 6, column 3 amended, on 1 February 2021, by clause 48(a) of the Electricity Industry Participation Code Amendment (Metering and Related Registry Processes) 2020. Table 1: row 16 amended, on 29 August 2013, by clause 52(1) of the Electricity Industry Participation (Metering Arrangements) Code Amendment 2011, Amendment 2013 (No 2).

Electricity Industry Participation Code 2010
Schedule 11.4

Table 1: row 18, column 3 amended, on 1 February 2021, by clause 48(b) of the Electricity Industry Participation Code Amendment (Metering and Related Registry Processes) 2020.

Table 1: row 19 amended, on 29 August 2013, by clause 52(2) of the Electricity Industry Participation (Metering Arrangements) Code Amendment 2011, Amendment 2013 (No 2).

Table 1: row 19, column 2 amended, on 1 February 2021, by clause 48(c) of the Electricity Industry Participation Code Amendment (Metering and Related Registry Processes) 2020.

Table 1: row 19, column 3 replaced, on 1 February 2021, by clause 48(c) of the Electricity Industry Participation Code Amendment (Metering and Related Registry Processes) 2020.

Table 1: row 21 amended, on 29 August 2013, by clause 52(3) of the Electricity Industry Participation (Metering Arrangements) Code Amendment 2011, Amendment 2013 (No 2).

Table 1: row 21 replaced, on 5 October 2017, by clause 279(b) of the Electricity Industry Participation Code Amendment (Code Review Programme) 2017.

Table 1: row 23 amended, on 15 May 2014, by clause 31 of the Electricity Industry Participation (Minor Code Amendments) Code Amendment 2014.

Table 1: row 30 amended, on 29 August 2013, by clause 5(1) of the Electricity Industry Participation (Metering Arrangements) Code Amendment 2011, Amendment 2013 (No 3).

Table 1: rows 22 to 30 substituted, on 1 February 2016, by clause 45 of the Electricity Industry Participation Code Amendment (Code Review Programme) 2015.

Table 1: rows 23 to 30, columns 4 and 5 amended, on 1 February 2021, by clause 48(d) of the Electricity Industry Participation Code Amendment (Metering and Related Registry Processes) 2020.

Schedule 11.5

cl 11.15C

Process for trader event of default

Schedule 11.5: inserted, on 16 December 2013, by clause 7 of the Electricity Industry Participation (Managing Retailer Default Situations) Code Amendment 2013.

Schedule 11.5, heading: amended, on 28 February 2015, by clause 8 of the Electricity Industry Participation Code Amendment (Trader Default) 2014.

1 Purpose

The purpose of this Schedule is to set out the process that the **Authority** and each **participant** must comply with when the **Authority** is satisfied that a **trader** has committed an **event of default** under paragraph (a) or (b) or (f) or (h) of clause 14.41.

Clause 1: amended, on 28 February 2015, by clause 9 of the Electricity Industry Participation Code Amendment (Trader Default) 2014.

Clause 1: amended, on 24 March 2015, by clause 6 of the Electricity Industry Participation Code Amendment (Settlement and Prudential Security) 2014.

2 Notice to trader who has committed event of default

(1) If the **Authority** is satisfied that a **trader** ("defaulting trader") has committed an **event of default** under paragraph (a) or (b) or (f) or (h) of clause 14.41 the **Authority** must give written notice to the defaulting **trader** that—

(a) the defaulting **trader** must—

(i) remedy the **event of default**; or

(ii) assign its rights and obligations under every contract under which a customer of the defaulting **trader** purchases **electricity** from the defaulting **trader** to another **trader**, and assign to another **trader** all **ICPs** for which the defaulting **trader** is recorded in the **registry** as being responsible; and

(b) if the defaulting **trader** does not comply with the requirements set out in paragraph (a) within 7 days of the notice, clause 4 will apply.

(2) The **Authority** may give written notice to the defaulting **trader** requiring the defaulting **trader** to provide to the **Authority**, within a time specified by the **Authority**, information about the defaulting **trader's** customers.

(3) The defaulting **trader** must provide the information requested by the **Authority** under subclause (2) within the time specified by the **Authority**.

Clause 2, heading: amended, on 28 February 2015, by clause 10(1) of the Electricity Industry Participation Code Amendment (Trader Default) 2014.

Clause 2(1): amended, on 28 February 2015, by clause 10(2) of the Electricity Industry Participation Code Amendment (Trader Default) 2014.

Clause 2(1): amended, on 24 March 2015, by clause 7 of the Electricity Industry Participation Code Amendment (Settlement and Prudential Security) 2014.

Clause 2(1) and (2): amended, on 5 October 2017, by clause 280 of the Electricity Industry Participation Code Amendment (Code Review Programme) 2017.

Clause 2(1)(a)(ii): amended, on 1 November 2018, by clause 67(a) of the Electricity Industry Participation Code Amendment (Code Review Programme) 2018.

Clause 2(2): amended, on 28 February 2015, by clause 10(3) of the Electricity Industry Participation Code Amendment (Trader Default) 2014.

Clause 2(2): amended, on 1 November 2018, by clause 67(b) of the Electricity Industry Participation Code Amendment (Code Review Programme) 2018.

Clause 2(3): amended, on 28 February 2015, by clause 10(4) of the Electricity Industry Participation Code Amendment (Trader Default) 2014.

3 Authority may require distributor, registry manager, and metering equipment provider to provide information

- (1) The **Authority** may, by notice in writing to a **distributor** on whose **network** a defaulting **trader** trades **electricity**, require the **distributor** to provide to the **Authority** the information specified in the notice about the defaulting **trader's** customers within the period specified in the notice.
- (2) If the **distributor** holds the information, the **distributor** must provide the information to the **Authority** within the time specified by the **Authority**.
- (3) The **Authority** may, by notice in writing to the **registry manager**, require the **registry manager** to provide to the **Authority** the information, specified in the notice, about **ICPs** for which a defaulting **trader** is recorded in the **registry** as being responsible, within the period specified in the notice.
- (4) If the **registry manager** holds the information, the **registry manager** must provide the information to the **Authority** within the time specified by the **Authority**.
- (5) The **Authority** may, by notice in writing to a **metering equipment provider** who is recorded in the **registry** as the **metering equipment provider** for an **ICP** for which a defaulting **trader** is responsible, require the **metering equipment provider** to provide to the **Authority** the information, specified in the notice, about the **ICPs** for which the defaulting **trader** is recorded in the **registry** as being responsible, within the period specified in the notice.
- (6) If the **metering equipment provider** holds the information, the **metering equipment provider** must provide the information to the **Authority** within the time specified by the **Authority**.

Clause 3 Heading: amended, on 5 October 2017, by clause 281(1) of the Electricity Industry Participation Code Amendment (Code Review Programme) 2017.

Clause 3 Heading: amended, on 7 September 2020, by clause 4(1) of the Electricity Industry Participation Code Amendment (Improving Trader Default Process) 2020.

Clause 3(1): amended, on 28 February 2015, by clause 11(1) of the Electricity Industry Participation Code Amendment (Trader Default) 2014.

Clause 3(1): amended, on 1 November 2018, by clause 68 of the Electricity Industry Participation Code Amendment (Code Review Programme) 2018.

Clause 3(1): amended, on 7 September 2020, by clause 4(2) of the Electricity Industry Participation Code Amendment (Improving Trader Default Process) 2020.

Clause 3(2): amended, on 7 September 2020, by clause 4(3) of the Electricity Industry Participation Code Amendment (Improving Trader Default Process) 2020.

Clause 3(3): amended, on 28 February 2015, by clause 11(2) of the Electricity Industry Participation Code Amendment (Trader Default) 2014.

Clause 3(3) and (4): replaced, on 7 September 2020, by clause 4(4) and (5) of the Electricity Industry Participation Code Amendment (Improving Trader Default Process) 2020.

Clause 3(3) and (4): amended, on 5 October 2017, by clause 281(2) of the Electricity Industry Participation Code Amendment (Code Review Programme) 2017.

Clause 3(5) and (6): inserted, on 7 September 2020, by clause 4(6) of the Electricity Industry Participation Code Amendment (Improving Trader Default Process) 2020.

4 Failure by defaulting trader to remedy event of default

- (1) This clause applies if—
 - (a) 7 days or more have elapsed since the **Authority** gave notice to the defaulting **trader** under clause 2(1); and
 - (b) the **Authority** considers that—
 - (i) the defaulting **trader** has not remedied the **event of default** or, in the case of an **event of default** under clause 14.41(b) in respect of which there is an

- unresolved invoice dispute under clause 14.25, has not reached an agreement with the **Authority** to resolve the **event of default**; and
- (ii) the defaulting **trader** still has 1 or more contracts under which a customer of the defaulting **trader** purchases **electricity** from the defaulting **trader** or is still recorded in the **registry** as being responsible for 1 or more **ICPs**.
- (2) The **Authority** must—
- (a) give written notice to the defaulting **trader** that the **Authority** considers that this clause applies; and
- (b) unless the **Authority** considers there is good reason not to, attempt to advise customers of the defaulting **trader** that the defaulting **trader** has committed an **event of default** and one or more of the following:
- (i) *[Revoked]*
- (ii) the customer should enter into a contract for the purchase of **electricity** with another **trader** by the date that is 14 days after the day on which the **Authority** gave written notice to the defaulting **trader** under clause 2(1):
- (iii) if the customer fails to enter into a contract with another **trader** by that date, the **Authority** may assign the defaulting **trader's** rights and obligations under the customer's contract with the defaulting **trader** to another **trader** under clause 5:
- (iv) any other information the **Authority** considers appropriate.
- (3) *[Revoked]*
- (4) *[Revoked]*
- Clause 4, heading: amended, on 28 February 2015, by clause 12(1) of the Electricity Industry Participation Code Amendment (Trader Default) 2014.
- Clause 4(1): amended, on 28 February 2015, by clause 12(2) of the Electricity Industry Participation Code Amendment (Trader Default) 2014.
- Clause 4(1)(a): amended, on 7 September 2020, by clause 5(1) of the Electricity Industry Participation Code Amendment (Improving Trader Default Process) 2020.
- Clause 4(1)(b)(i): amended, on 24 March 2015, by clause 8 of the Electricity Industry Participation Code Amendment (Settlement and Prudential Security) 2014.
- Clause 4(1)(b)(ii): amended, on 1 November 2018, by clause 69(a) of the Electricity Industry Participation Code Amendment (Code Review Programme) 2018.
- Clause 4(2)(a): amended, on 28 February 2015, by clause 12(3)(a) of the Electricity Industry Participation Code Amendment (Trader Default) 2014.
- Clause 4(2)(a) and (b): amended, on 5 October 2017, by clause 282 of the Electricity Industry Participation Code Amendment (Code Review Programme) 2017.
- Clause 4(2)(b): substituted, on 28 February 2015, by clause 12(3)(b) of the Electricity Industry Participation Code Amendment (Trader Default) 2014.
- Clause 4(2)(b): amended, on 1 November 2018, by clause 69(b) of the Electricity Industry Participation Code Amendment (Code Review Programme) 2018.
- Clause 4(2)(b): replaced, on 7 September 2020, by clause 5(2) of the Electricity Industry Participation Code Amendment (Improving Trader Default Process) 2020.
- Clause 4(2)(b)(ii) and (iii): amended, on 1 November 2018, by clause 69(c) and (d) of the Electricity Industry Participation Code Amendment (Code Review Programme) 2018.
- Clause 4(3) and 4(4): revoked, on 28 August 2015, by clause 12(4) of the Electricity Industry Participation Code Amendment (Trader Default) 2014.

4A Trader to provide information about NSPs and ICPs at which it cannot trade

- (1) If the **Authority** gives written notice to a **trader** under clause 4, the **Authority** must give written notice to each **trader** (except the defaulting **trader**) that it must provide the

information specified in subclause (2) to the **registry manager** by no later than 1600 on the **business day** following the day on which the notice under this subclause was given.

- (2) The information that a **trader** must provide to the **registry manager** is—
- (a) the **NSPs** at which the **trader** cannot trade because it does not have an arrangement with the relevant **distributor** on whose network the **NSPs** are located to trade at the **NSP**; and
 - (b) the **ICPs** at which the **trader** cannot trade for any of the following reasons:
 - (i) the type of each **meter** at the **ICPs** (for example, **half hour**, non **half hour**, or prepay);
 - (ii) the **price category code** assigned to the **ICPs**;
 - (iii) the **metering installation** category of the **metering installation** at the **ICPs**;
 - (iv) the **installation type** code assigned to the **ICPs**; and
 - (c) the reasons, being 1 or more reasons specified in paragraph (a) and (b), for the **trader** being unable to trade at the **NSPs** or **ICPs**.
- (3) A **trader** must comply with a notice given to it under subclause (1).

Clause 4A: inserted, on 28 August 2015, by clause 13 of the Electricity Industry Participation Code Amendment (Trader Default) 2014.

Clause 4A(1): amended, on 5 October 2017, by clause 283 of the Electricity Industry Participation Code Amendment (Code Review Programme) 2017.

4B Authority may direct registry manager not to process certain ICP switching activities

- (1) If the **Authority** gives written notice to a **trader** under clause 2, the **Authority** may, by written notice to the **registry manager**, direct the **registry manager** not to—
- (a) process the initiation or completion of the switch of any **ICP** to the defaulting **trader**; or
 - (b) process a switch withdrawal request under clauses 17 and 18 of Schedule 11.3 if processing the switch withdrawal request would mean the defaulting **trader** retained responsibility for the **ICP** to which the switch withdrawal request applies.
- (2) If the **Authority** gives written notice under subclause (1), the **registry manager** must comply with the notice.

Clause 4B: replaced, on 7 September 2020, by clause 6 of the Electricity Industry Participation Code Amendment (Improving Trader Default Process) 2020.

Clause 4B Heading: amended, on 5 October 2017, by clause 284(1) of the Electricity Industry Participation Code Amendment (Code Review Programme) 2017.

Clause 4B: amended, on 5 October 2017, by clause 284(2) of the Electricity Industry Participation Code Amendment (Code Review Programme) 2017.

Clause 4B: inserted, on 28 August 2015, by clause 13 of the Electricity Industry Participation Code Amendment (Trader Default) 2014.

5 Authority may assign contracts and ICPs

- (1) This clause applies if, by the end of the 17th day after the defaulting **trader** was given notice under clause 2(1),—
- (a) the defaulting **trader** has not remedied the **event of default** or, in the case of an **event of default** under clause 14.41(b) in respect of which there is an unresolved invoice dispute under clause 14.25, has not reached an agreement with the **Authority** to resolve the **event of default**; and

- (b) the defaulting **trader** continues to have 1 or more contracts under which a customer of the defaulting **trader** purchases **electricity** from the defaulting **trader** or the defaulting **trader** is still recorded in the **registry** as being responsible for 1 or more **ICPs**.
- (2) The **Authority** may—
 - (a) exercise its right under a contract under which a customer purchases **electricity** from the defaulting **trader** to assign the rights and obligations of the defaulting **trader** under the contract to a recipient **trader** in accordance with the contract; and
 - (b) assign an **ICP** to a recipient **trader** and direct the **registry manager** to amend the record in the **registry** so that the recipient **trader** is recorded as being responsible for the **ICP**; and
 - (c) specify the recipient **trader** to whom the rights and obligations under the contract or the **ICP** will be assigned.
- (2A) When determining an assignment under subclause (2), the **Authority** may do 1 or both of the following:
 - (a) exercise its discretion to determine the recipient **trader** without going through a tender or other competitive process;
 - (b) undertake a tender or other competitive process to determine the recipient **trader**.
- (3) The **Authority** must, by notice in writing to each recipient **trader**, direct the recipient **trader** to accept an assignment under subclause (2).
- (4) Before the **Authority** gives notice to a recipient **trader** under subclause (3), the **Authority** may decide not to assign rights and obligations of the defaulting **trader** under a contract or an **ICP** to a recipient **trader** if the recipient **trader** satisfies the **Authority** that the assignment would pose a serious threat to the financial viability of the recipient **trader**.
- (5) A recipient **trader** must comply with a direction given to it under subclause (3).
- (6) The **registry manager** must comply with a direction given to it under subclause (2).
- (7) Before the **Authority** exercises its right to assign rights and obligations or an **ICP** under subclause (2), the **Authority** must, if the **Authority** considers it is practicable, consult with the defaulting **trader** as to the need for the notice.

Clause 5, heading: amended, on 28 February 2015, by clause 14(1) of the Electricity Industry Participation Code Amendment (Trader Default) 2014.

Clause 5(1): amended, on 28 February 2015, by clause 14(2) of the Electricity Industry Participation Code Amendment (Trader Default) 2014.

Clause 5(1)(a): amended, on 24 March 2015, by clause 9 of the Electricity Industry Participation Code Amendment (Settlement and Prudential Security) 2014.

Clause 5(1)(b): amended, on 1 November 2018, by clause 70 of the Electricity Industry Participation Code Amendment (Code Review Programme) 2018.

Clause 5(2) to (8): amended, on 28 February 2015, by clause 14(3) of the Electricity Industry Participation Code Amendment (Trader Default) 2014.

Clause 5(2)(a): amended, on 1 November 2018, by clause 70 of the Electricity Industry Participation Code Amendment (Code Review Programme) 2018.

Clause 5(2)(b): amended, on 5 October 2017, by clause 285(a) of the Electricity Industry Participation Code Amendment (Code Review Programme) 2017.

Clause 2A: inserted, on 7 September 2020, by clause 7(1) of the Electricity Industry Participation Code Amendment (Improving Trader Default Process) 2020.

Clause 5(6): amended, on 5 October 2017, by clause 285(b) of the Electricity Industry Participation Code Amendment (Code Review Programme) 2017.

Clause 5(8): deleted, on 7 September 2020, by clause 7(2) of the Electricity Industry Participation Code Amendment (Improving Trader Default Process) 2020.

5A Effect of assignment

If the **Authority** assigns an **ICP** to a recipient **trader** under clause 5, and at the time of the assignment the recipient **trader** does not comply with clause 10.24(a) in relation to the **ICP**, the recipient **trader** is excused from complying with that clause for the first 3 months after the assignment.

Clause 5A: inserted, on 28 August 2015, by clause 15 of the Electricity Industry Participation Code Amendment (Trader Default) 2014.

6 Authority must provide information to recipient trader

If the **Authority** exercises its right to assign rights and obligations or an **ICP** under clause 5(2), the **Authority** must provide the following information to each recipient **trader**:

- (a) the number of customer contracts (to the extent that the **Authority** has the information) and **ICPs** assigned to the **trader**; and
- (b) any information that the **Authority** holds about the customers and **ICPs** assigned to the **trader**.

Clause 6, heading: amended, on 28 February 2015, by clause 16(1) of the Electricity Industry Participation Code Amendment (Trader Default) 2014.

Clause 6: amended, on 28 February 2015, by clause 16(2) of the Electricity Industry Participation Code Amendment (Trader Default) 2014.

Clause 6(a) and (b): amended, on 1 November 2018, by clause 71(a) and (b) of the Electricity Industry Participation Code Amendment (Code Review Programme) 2018.

7 Authority may direct registry manager to process certain ICP switching activities

(1) If the **Authority** gives written notice to a defaulting **trader** under clause 2, the **Authority** may, by written notice to the **registry manager**, even if the defaulting **trader** has not complied with its obligations under Schedule 11.3, direct the **registry manager** to—

- (a) initiate and complete the switch of an **ICP** away from the defaulting **trader**; or
- (b) process the initiation or completion of the switch of an **ICP** away from the defaulting **trader**; or
- (c) cancel the switch of an **ICP** to the defaulting **trader**; or
- (d) process the completion of a switch withdrawal request under clauses 17 and 18 of Schedule 11.3 for an **ICP** that is being switched to the defaulting **trader**; or
- (e) cancel a switch withdrawal request made under clauses 17 and 18 of Schedule 11.3 for an **ICP** that is being switched away from the defaulting **trader**.

(2) The **registry manager** must, as soon as possible, comply with a direction given by the **Authority** in a written notice.

Clause 7: replaced, on 7 September 2020, by clause 8 of the Electricity Industry Participation Code Amendment (Improving Trader Default Process) 2020.

Clause 7 Heading: amended, on 5 October 2017, by clause 286(1) of the Electricity Industry Participation Code Amendment (Code Review Programme) 2017.

Clause 7: amended, on 28 February 2015, by clause 17 of the Electricity Industry Participation Code Amendment (Trader Default) 2014.

Clause 7: amended, on 5 October 2017, by clause 286(2) of the Electricity Industry Participation Code Amendment (Code Review Programme) 2017.

8 Terms of assigned contract

- (1) If the **Authority** exercises its right to assign rights and obligations under clause 5(2), the **Authority** must attempt to advise the customer that the terms of the contract may be amended on assignment.
- (2) The recipient **trader** must use reasonable endeavours to advise the customer of those terms.

Clause 8(1) and (2): amended, on 1 November 2018, by clause 72 of the Electricity Industry Participation Code Amendment (Code Review Programme) 2018.

Clause 8(2): amended, on 28 February 2015, by clause 18 of the Electricity Industry Participation Code Amendment (Trader Default) 2014.

Schedule 11.6

Forms for authorisation of an Agent to request consumption information

Schedule 11.6 inserted, on 1 March 2020, by clause 7 of the Electricity Industry Participation Code Amendment (Requirements and Processes for Information Requests by Agents) 2020.

Form 1: Form for authorisation by an individual (being a natural person)

Consumer: [Consumer full name]

Property: [property address (es)]

Customer number¹: [customer number]

Installation Control Points (ICP(s)) Identifier(s): [List all ICPs]

Retailer: [name of Retailer]

Agent: [full name of Agent and contact details]

Period of authority: [enter period of authorisation to Agent]

I (being the Consumer named above) confirm that I own or occupy the Property identified above (or owned or occupied that property at the relevant time) or otherwise am or was responsible for the consumption of electricity at the Property.

I confirm that I am or have been a customer of the Retailer identified above in relation to the Property and ICP(s) identified above.

I authorise:

- (a) the Agent identified above to request, receive and hold information on my behalf about electricity consumption for the Property or the ICP(s); and
- (b) the Retailer to transfer information on my behalf about electricity consumption for the Property or ICP(s) to the Agent.

[Signature/electronic signature of Consumer or of a person on behalf of the Consumer (in which case, evidence of that person's authority to sign on behalf of the Consumer is required) or other evidence of Consumer's agreement]

¹ This is the customer number assigned to the Customer by the Retailer to whom the request is being made.

Form 2: Form for authorisation by a non-individual (not being a natural person)

Consumer: [Consumer full name]

Authorised Representative of Consumer: [Full name and title/position with Consumer]

Property: [property address (es)]

Customer number²: [customer number]

Installation Control Points (ICP(s)) Identifier(s): [List all ICPs]

Retailer: [name of Retailer]

Agent: [full name of Agent and contact details]

Period of authority [enter period of authorisation to Agent]

The Consumer identified above owns or occupies the Property identified above (or owned or occupied that property at the relevant time) or otherwise is or was responsible for the consumption of electricity at the Property.

The Consumer is or has been a customer of the Retailer identified above in relation to the Property and, ICP(s) identified above.

The Consumer authorises:

(a) the Agent identified above to request, receive and hold information on the Consumer's behalf about electricity consumption for the Property or the ICP(s); and

(b) the Retailer to transfer information on the Consumer's behalf about electricity consumption for the Property or ICP(s) to the Agent.

In signing this form as the Authorised representative of the Consumer, I warrant that I am authorised to sign this form and agree to the matters above on behalf of the Consumer.

[Signature/electronic signature of Authorised Representative].

² This is the customer number assigned to the Customer by the Retailer to whom the request is being made.

Electricity Industry Participation Code 2010

Part 12 Transport

Contents

Subpart 1—General

- 12.1 Contents of this Part
Discretion to waive Code requirements
- 12.2 Interaction between Parts 7 and 8 and this Part
- 12.3

Subpart 2—Transmission agreements

- 12.4 Contents of this subpart
- 12.5 Structure for transmission agreements *[Revoked]*
- 12.6 Review of structure for transmission agreements *[Revoked]*
- 12.7 Categories of participants required to enter into transmission agreements
Transpower and designated transmission customers must enter transmission agreements
- 12.8 Obligation to enter transmission agreements
- 12.9 When designated transmission customer must enter into transmission agreement
- 12.10 Default transmission agreements
- 12.11 Subsequent transmission agreements
- 12.12 Changes to connection assets under default transmission agreements
- 12.13 Expiry or termination of transmission agreements

Content of transmission agreements

- 12.14 Transmission agreements to be consistent with default transmission agreement template and grid reliability standards
- 12.15 Transpower to publish information about transmission agreements and provide them on request

Connection Code

- 12.16 Connection Code *[Revoked]*
- 12.17 Purpose of Connection Code
- 12.18 Review of Connection Code
- 12.19 Transpower to submit Connection Code
- 12.20 Required content of Connection Code
- 12.21 Principles for developing Connection Code
- 12.22 Authority may initially approve proposed Connection Code or refer back to Transpower
- 12.23 Amendment of proposed Connection Code by Authority
- 12.24 Authority must consult on proposed Connection Code
- 12.25 Decision on Connection Code
- 12.26 Incorporation of Connection Code by reference *[Revoked]*

Default transmission agreement template

- 12.27 Benchmark agreement *[Revoked]*
- 12.28 Authority may initiate review *[Revoked]*
- 12.29 Purpose of default transmission agreement template
- 12.30 Principles for default transmission agreement template
- 12.31 Contents of default transmission agreement template
- 12.32 Authority must consult on draft benchmark agreement *[Revoked]*
- 12.33 Decision on benchmark agreement *[Revoked]*
- 12.34 Incorporation of benchmark agreement by reference *[Revoked]*

Variations from default transmission agreement template and grid reliability standards and enhancement and removal of connection assets

- 12.35 Increased service levels and reliability
- 12.36 Decreased service levels and reliability
- 12.37 Variations that may increase or decrease reliability
- 12.38 Other variations from terms of default transmission agreement template
- 12.39 Customer specific value of expected unserved energy
- 12.40 Replacement and enhancement of shared connection assets
- 12.41 Removal of shared connection assets from service
- 12.42 Reconfiguration of shared connection assets
- 12.43 Net benefits test
- 12.44 Request to the Commerce Commission to request an investment proposal be submitted

Resolutions of disputes

- 12.45 Certain disputes relating to transition agreements may be referred to Rulings Panel
- 12.46 Rulings Panel has discretion to determine dispute
- 12.47 Determinations by Rulings Panel
- 12.48 Status of default transmission agreement while Rulings Panel determining dispute

Existing agreements not affected

- 12.49 Existing agreements
- 12.50 Copies of other agreements to be provided to the Authority
- 12.51 Application to Rio Tinto agreements *[Revoked]*

Subpart 3—Grid reliability and industry information

- 12.52 Contents of this subpart
- 12.53 Purpose of the reliability and industry information clauses
- 12.54 Obligations to provide information

Grid reliability standards

- 12.55 Authority determines grid reliability standards
- 12.56 Purpose of grid reliability standards
- 12.57 Principles of grid reliability standards
- 12.58 Content of grid reliability standards

Review of grid reliability standards

- 12.59 Interested parties may request review of grid reliability standards
- 12.60 Authority review of grid reliability standards
- 12.61 Authority must publish draft grid reliability standards
- 12.62 Decision on grid reliability standards

Core grid determination

- 12.63 Authority determines core grid determination
- 12.64 Purpose of core grid determination
- 12.65 Objectives of core grid determination

Review of core grid determination

- 12.66 Interested parties may request review of core grid determination
- 12.67 Authority review of grid determination
- 12.68 Authority must publish draft core grid determination
- 12.69 Decision on core grid determination

Investment contracts

- 12.70 Purpose
- 12.71 Investment contracts

Centralised data set [Revoked]

- 12.72 Authority to establish and maintain centralised data set *[Revoked]*
- 12.73 Purpose of centralised data set *[Revoked]*
- 12.74 Contents of centralised data set *[Revoked]*
- 12.75 Public access to centralised data set *[Revoked]*

Grid reliability reporting

- 12.76 Transpower to publish grid reliability report

Subpart 4—Transmission pricing methodology

- 12.77 Recovery of investment costs by Transpower
- 12.78 Purpose for establishing transmission pricing methodology
- 12.79 Main statutory objective
- 12.80 Application and interpretation of pricing principles *[Revoked]*
- 12.81 Authority must prepare an issues paper
- 12.82 Authority must consult on issues paper
- 12.83 Authority must publish process and guidelines for development of transmission pricing methodology

Development of transmission pricing methodology by Transpower

- 12.84 Transmission pricing methodology

Review of an approved transmission pricing methodology

- 12.85 Review by Transpower
- 12.86 Review by Authority
- 12.87 Process for review
- 12.88 Transpower to submit methodology
- 12.89 Form of proposed transmission pricing methodology
- 12.90 Authority may decline to consider proposed transmission pricing methodology

Process for Authority determination of transmission pricing methodology

- 12.91 Authority may approve proposed transmission pricing methodology or refer back to Transpower
- 12.92 Authority must publish proposed transmission pricing methodology
- 12.93 Decision on transitional pricing methodology
- 12.94 Authority to determine commencement date

- 12.94A *Amending the transmission pricing methodology*
Amending the transmission pricing methodology
Application of approved transmission pricing methodology
- 12.95 Charges to comply with transmission pricing methodology
- 12.96 Development of transmission prices
Audit of transmission prices
- 12.97 Audit of transmission prices
- 12.98 Transpower may respond to auditor's report
- 12.99 Final auditor report to the Authority
- 12.100 Transpower to redetermine transmission prices
- 12.101 Auditor's costs
- 12.102 Enforcement of transmission charges
Information for calculating transmission charges
- 12.102A Information held by system operator may be used to calculate charges
- 12.102B Information about embedded electricity
Subpart 5—Financial transmission rights *[Revoked]*
- 12.103 Contents of this subpart *[Revoked]*
- 12.104 Design *[Revoked]*
Subpart 6—Interconnection asset services
- 12.105 Purpose of this subpart
- 12.106 Interconnection asset capacity and grid configuration
- 12.107 Transpower to identify interconnection branches, and propose service measures and levels
- 12.108 Consultation on proposed interconnection asset capacity and grid configuration
- 12.109 Decision on interconnection asset capacity and grid configuration
- 12.110 Incorporation of interconnection asset capacity and grid configuration by reference
- 12.111 Transpower to make interconnection branches and other assets available and keep grid configuration
- 12.112 Exceptions to clause 12.111
- 12.113 Transpower to maintain interconnection assets
Transpower to propose investments
- 12.114 Investments to meet the grid reliability standards
- 12.115 Other investments
- 12.116 Information on capacities of individual interconnection assets
- 12.116AA Temporary removal of interconnection assets from service or temporary grid reconfiguration
- 12.116AB *[Expired]*
- 12.116AC Information to be published
- 12.116A *[Expired]*
- 12.116B *[Expired]*
- 12.116C *[Expired]*
- 12.117 Permanent removal of interconnection assets from service or permanent grid reconfiguration
- 12.118 Transpower to provide and publish annual report on interconnection asset capacity and grid configuration

Reporting on availability and reliability

- 12.119 Index measures for availability and reliability
- 12.120 Updating of availability and reliability index measures
- 12.121 Transpower to submit draft index measures for availability and reliability
- 12.122 Requirements for index measures
- 12.123 Authority may initially approve proposed index measures or refer back to Transpower
- 12.124 Amendment of proposed index measures by the Authority
- 12.125 Authority must consult on proposed index measures
- 12.126 Decision on index measures
- 12.127 Transpower to report on availability and reliability
- 12.128 Transpower and designated transmission customers may agree on other requirements

Subpart 7—Preparation of Outage Protocol

- 12.129 Purpose of this subpart
- 12.130 Definition of outage
- 12.131 Outage protocol

Review of Outage Protocol

- 12.132 Review of Outage Protocol
- 12.133 Transpower to submit proposed Outage Protocol

Principles and required content of Outage Protocol

- 12.134 Principles for developing Outage Protocol
- 12.135 Required content of Outage Protocol
- 12.136 Planning for outages
- 12.137 Transpower and designated transmission customers to act reasonably and in good faith
- 12.138 Reconsideration of planned outages
- 12.139 Variations to planned outages
- 12.140 Net benefit principle, requirements and methodologies
- 12.141 Consideration of likely effects of planned outages
- 12.142 Planned outages required in order to give effect to an investment or required by the Act
- 12.143 Required content of Outage Protocol in relation to unplanned outages
- 12.144 Reporting on compliance with Outage Protocol

Decisions on Outage Protocol

- 12.145 Authority may initially approve the proposed Outage Protocol or refer back to Transpower
- 12.146 Reconsideration of revised Outage Protocol by the Authority
- 12.147 Authority must consult on the proposed Outage Protocol
- 12.148 Authority may undertake additional consultation
- 12.149 Decision on Outage Protocol
- 12.150 Incorporation of Outage Protocol by reference

Complying with Outage Protocol

- 12.151 Compliance with Outage Protocol

Schedule 12.1
Categories of designated transmission customers

Schedule 12.2
Grid reliability standards

Schedule 12.3
Core grid determination

Schedule 12.4
Transmission Pricing Methodology

Part A - Preliminary

Part B - Grid Asset Classification

Part C - Connection Charges

Part D - Benefit-based Charges

Part E - Residual Charges

Part F - Adjustments

Part G - Reassignment

Part H - Transitional Price Gap

Part I - Prudent Discount Policy

Appendix A: BBIs and Starting BBI Customer Allocations

Schedule 12.5
Availability and reliability index measures

Schedule 12.6
Default transmission agreement template

Subpart 1—General

12.1 Contents of this Part

This Part relates to the following aspects of transmission:

- (a) **transmission agreements** (subpart 2):
- (b) **grid** reliability and industry information (subpart 3):
- (c) the **transmission pricing methodology** (subpart 4):
- (d) *[Revoked]*
- (e) **interconnection asset** services (subpart 6):
- (f) the **Outage Protocol** (subpart 7).

Compare: Electricity Governance Rules 2003 rule 1 section I part F

Clause 12.1(d): revoked, on 1 October 2011, by clause 5 of the Electricity Industry Participation (Financial Transmission Rights) Code Amendment 2011.

12.2 Discretion to waive Code requirements

- (1) The **Authority** may agree to waive Code requirements under this Part if, before the commencement of an amendment to this Part,—
 - (a) **Transpower** or any other **participant** required to complete actions under this Code has in substance done what it would have been required to do under this

Code; and

- (b) the **Authority** is satisfied that the actions have been completed.
- (2) If the **Authority** agrees to waive Code requirements under subclause (1), the **Authority** must **publish** its decision and reasons for agreeing to waive Code requirements.

Compare: Electricity Governance Rules 2003 rule 2 section I part F

12.3 Interaction between Parts 7 and 8 and this Part

- (1) The **principal performance obligations** in relation to the real time delivery of **common quality and dispatch** under Part 7 relate to the functions and obligations of the **system operator**.
- (2) When it is exercising its functions and powers under this Part, the **Authority** must have regard to the desirability of Parts 7 and 8 and this Part operating in an integrated and consistent manner.
- (3) The performance or non-performance of a function or obligation of the **system operator** under Parts 7 or 8, and a claim against the **system operator** under Parts 7 or 8, is without prejudice to the functions and obligations of **Transpower** under this Part.
- (4) The performance or non-performance of a function or obligation of **Transpower** under this Part, and any claim against **Transpower** under this Part or a **transmission agreement**, is without prejudice to the functions and obligations of the **system operator** under Parts 7 or 8.

Compare: Electricity Governance Rules 2003 rule 3 section I part F

Subpart 2—Transmission agreements

12.4 Contents of this subpart

This subpart deals with **transmission agreements**, and provides for the following:

- (a) *[Revoked]*
- (b) the categories of **participants** that must enter into **transmission agreements**:
- (c) an obligation on **Transpower** and **designated transmission customers** to enter into **transmission agreements**:
- (d) matters to be included in **transmission agreements**:
- (e) provisions relating to the **default transmission agreement template**, which—
- (i) provides the basis for the negotiation of **transmission agreements**; or
- (ii) provides the basis for a **default transmission agreement**:
- (f) a process for the **Authority** to determine a **Connection Code** that forms part of the **default transmission agreement template**:
- (g) a process for variations in **transmission agreements** from the **default transmission agreement template**:
- (h) a process for resolving disputes arising from the negotiation of **transmission agreements** and the failure to agree to the terms of **default transmission agreements**:
- (i) existing agreements.

Compare: Electricity Governance Rules 2003 rule 1 section II part F

Clause 12.4(a): revoked, on 1 October 2023, by clause 5(1) of the Electricity Industry Participation Code Amendment (Default Transmission Agreement) 2023.

Clauses 12.4(e) to 12.4(h): amended, on 1 October 2023, by clause 5(2) of the Electricity Industry Participation Code Amendment (Default Transmission Agreement) 2023.

12.5 Structure for transmission agreements *[Revoked]*

Compare: Electricity Governance Rules 2003 rule 2.1.2 section II part F
Clause 12.5: revoked, on 1 October 2023, by clause 6 of the Electricity Industry Participation Code Amendment (Default Transmission Agreement) 2023.

12.6 Review of structure for transmission agreements *[Revoked]*

Compare: Electricity Governance Rules 2003 rules 2.1.3 to 2.1.5 section II part F
Clause 12.6(3): amended, on 1 November 2018, by clause 73 of the Electricity Industry Participation Code Amendment (Code Review Programme) 2018.
Clause 12.6: revoked, on 1 October 2023, by clause 7 of the Electricity Industry Participation Code Amendment (Default Transmission Agreement) 2023.

12.7 Categories of participants required to enter into transmission agreements

- (1) The categories of **designated transmission customers** required to enter into **transmission agreements** with **Transpower** under clause 12.8 are as specified in Schedule 12.1.
- (2) The **Authority** must record in the **register** whether a **registered participant** is a **designated transmission customer**.
- (3) Registration has no effect on a **participant's** status as a **designated transmission customer**.

Compare: Electricity Governance Rules 2003 rule 2.2 section II part F

Transpower and designated transmission customers must enter transmission agreements

12.8 Obligation to enter transmission agreements

Transpower and **designated transmission customers** must enter into **transmission agreements**.

Compare: Electricity Governance Rules 2003 rule 3.1.1 section II part F

12.9 When designated transmission customer must enter into transmission agreement

A **participant** who becomes a **designated transmission customer** must enter into a **transmission agreement** with **Transpower** within 2 months after the **participant** becomes a **designated transmission customer**.

Compare: Electricity Governance Rules 2003 rule 3.1.2.3 section II part F

12.10 Default transmission agreements

- (1) Subject to clause 12.49 the terms in the **default transmission agreement template** (other than incomplete terms) apply as a **default transmission agreement** as soon as a **participant** becomes a **designated transmission customer**.
- (1A) Subject to clause 12.49, if, at the expiry of 2 months after a **participant** becomes a **designated transmission customer**, the **designated transmission customer** and **Transpower** have not entered into a **transmission agreement** in accordance with clause 12.9, the **designated transmission customer** and **Transpower** must comply with the process specified in this clause.
- (2) If this clause applies:

- (a) within 10 **business days** of the date that is 2 months after the **participant** became a **designated transmission customer**, the **designated transmission customer** must provide **Transpower**, at the address for service for **Transpower** registered at the New Zealand Companies Office, with—
 - (i) the **designated transmission customer's** full name; and
 - (ii) the **designated transmission customer's** physical address, postal address and electronic address to which notices under the **default transmission agreement** are to be sent; and
 - (iii) the name of the contact person of the **designated transmission customer** to whom such notices should be addressed:
- (b) by the date 20 **business days** after the receipt of the **designated transmission customer's** details under paragraph (a), **Transpower** must provide the **designated transmission customer** with a draft **default transmission agreement** completed in accordance with the **default transmission agreement template**, which must include the following:
 - (i) the **designated transmission customer's** details as provided under paragraph (a):
 - (ii) **Transpower's** physical address, postal address and electronic address to which notices under the **default transmission agreement** are to be sent:
 - (iii) the contact person to whom notices under the **default transmission agreement** should be addressed:
 - (iv) **Transpower's** designated bank account for the purposes of receiving payments under the **default transmission agreement**:
 - (v) draft Schedules 1 and 2, which set out the **connection locations, points of service** and **points of connection** of the **assets** owned or operated by the **designated transmission customer** to the **grid**:
 - (vi) a draft Schedule 4 setting out, in the same form as the diagram in Schedule 4 of the **default transmission agreement template**, the configuration of the **connection assets** in relation to each **connection location** listed in Schedule 1:
 - (vii) a draft Schedule 5 setting out proposed service levels for each **connection location** listed in Schedule 1 determined in accordance with subclause (3):
 - (viii) if applicable, a draft Schedule 6, including identifying the facilities, facilities area, and land that are to be subject to the access and occupation terms set out in the schedule and the licence charges under the schedule:
- (c) the **designated transmission customer** and **Transpower** may discuss the schedules proposed under paragraph (b)(v) to (viii), as a result of which **Transpower** may amend any of the schedules:
- (d) the **designated transmission customer** must advise **Transpower** in writing no later than 20 **business days** after receiving the draft **default transmission agreement** under paragraph (b) whether—
 - (i) it accepts the schedules as proposed by **Transpower** under paragraph (b)(v) to (viii); or
 - (ii) if **Transpower** has amended any of those schedules under paragraph (c), it

- accepts the schedules as amended.
- (3) The service levels set out in Schedule 5 of a **default transmission agreement** must be determined on the following basis:
- (a) the capacity service levels for each **branch** must be consistent with—
 - (i) the capacities of the **branch** or component **assets** in the most recent **asset capability statement** provided by **Transpower** under clause 2(5) of **Technical Code A** of Schedule 8.3; or
 - (ii) if the relevant information is not contained in the **asset capability statement**, the **manufacturer's specification** for the component **assets**:
 - (b) the service levels for the voltage range specified in the capacity service measures for each **branch** must be consistent with,—
 - (i) for **assets** of voltages of 50kV or above,—
 - (A) the voltage ranges for the component **assets** specified in the **AOPOs**, if any; or
 - (B) the voltage range specified in any **equivalence arrangement** approved or any **dispensation** granted under clauses 8.29 to 8.31 in respect of any **asset** that does not comply with the voltage range specified in the **AOPOs**; or
 - (ii) for assets of voltages less than 50kV, the normal operating voltage of the component **assets**:
 - (c) **Transpower** must ensure that each **connection asset** is included in a **branch**:
 - (d) the availability and reliability service levels must—
 - (i) be set at a level equivalent to the average annual availability and reliability at each **point of service** subject to the **default transmission agreement** over the 5 year period (being years ending 30 June) immediately before the date that is 2 months after the **participant** became a **designated transmission customer**; or
 - (ii) if a **point of service** subject to the **default transmission agreement** has not been in existence for 5 years (being years ending 30 June) before the date referred to in subparagraph (i), reflect a reasonable estimate of the expected availability and reliability at the **point of service** having regard to the performance data available for the **point of service** and average annual availability and reliability of **assets** similar to the **connection assets** at the **connection location** at which the **point of service** is located:
 - (e) the reporting and response service levels must be consistent with **Transpower's** practices existing on the date that is 2 months after the **participant** became a **designated transmission customer**, including **Transpower's** documented policies and procedures, and must not result in changes to the management or operation of the **grid** that could materially affect **Transpower** or any other **participant** or end use customer, or require **Transpower** to materially alter the level of its normal on-going **grid** expenditure.
- (4) If the **designated transmission customer** accepts the schedules as proposed by **Transpower** under subclause (2)(b)(v) to (viii), or as amended by **Transpower** under subclause (2)(c), the draft **default transmission agreement** proposed under subclause

- (2)(b)(v) to (viii), or as amended by **Transpower** under subclause (2)(c), (as applicable) is deemed to apply as a **default transmission agreement** from the date the **participant** became a **designated transmission customer**.
- (5) If **Transpower** and a **designated transmission customer** are unable to agree on the terms of any of the schedules proposed by **Transpower** under subclause (2)(b)(v) to (viii), or as amended by **Transpower** under subclause (2)(c), either party may refer the matter to the **Rulings Panel** for determination under clauses 12.45 to 12.48.
- (6) If a dispute is referred to the **Rulings Panel**, under subclause (5)—
- (a) the **default transmission agreement** as determined by the **Rulings Panel** in accordance with clauses 12.45 to 12.48 is deemed to apply between **Transpower** and the **designated transmission customer** from the date the **participant** became a **designated transmission customer**; and
 - (b) until the **Rulings Panel** makes a determination, the draft **default transmission agreement** proposed under subclause (2)(b)(v) to (viii), or as amended by **Transpower** under subclause (2)(c), (as applicable) is deemed to apply as a **default transmission agreement** from the date the **participant** became a **designated transmission customer**.

Compare: Electricity Governance Rules 2003 rule 3.1.3 section II part F

Clause 12.10 Heading: amended, on 1 October 2023, by clause 8(1) of the Electricity Industry Participation Code Amendment (Default Transmission Agreement) 2023.

Clause 12.10(1): amended, on 16 December 2013, by clause 5 of the Electricity Industry Participation (Revocation of Part 16) Code Amendment 2013.

Clause 12.10(1): amended, on 1 October 2023, by clause 8(2) of the Electricity Industry Participation Code Amendment (Default Transmission Agreement) 2023.

Clause 12.10(1A): inserted, on 1 October 2023, by clause 8(2) of the Electricity Industry Participation Code Amendment (Default Transmission Agreement) 2023.

Clause 12.10(2)(a)(ii) and (b)(ii): amended, on 5 October 2017, by clause 287 of the Electricity Industry Participation Code Amendment (Code Review Programme) 2017.

Clause 12.10(2): amended, on 1 October 2023, by clause 8(3) of the Electricity Industry Participation Code Amendment (Default Transmission Agreement) 2023.

Clause 12.10(3): amended, on 1 October 2023, by clause 8(3) of the Electricity Industry Participation Code Amendment (Default Transmission Agreement) 2023.

Clause 12.10(4): amended, on 1 October 2023, by clause 8(4) of the Electricity Industry Participation Code Amendment (Default Transmission Agreement) 2023.

Clause 12.10(4): amended, on 1 March 2024, by clause 55(1) of the Electricity Industry Participation Code Amendment (Code Review Programme) 2024.

Clause 12.10(5): amended, on 1 October 2023, by clause 8(5) of the Electricity Industry Participation Code Amendment (Default Transmission Agreement) 2023.

Clause 12.10(6)(a): amended, on 1 October 2023, by clause 8(6) of the Electricity Industry Participation Code Amendment (Default Transmission Agreement) 2023.

Clause 12.10(6)(b): amended, on 1 October 2023, by clause 8(7) of the Electricity Industry Participation Code Amendment (Default Transmission Agreement) 2023.

Clause 12.10(6): replaced, on 1 March 2024, by clause 55(2) of the Electricity Industry Participation Code Amendment (Code Review Programme) 2024.

12.11 Subsequent transmission agreements

If a **default transmission agreement** applies, it may be superseded by a subsequent **transmission agreement** entered into by **Transpower** and the **designated transmission customer**.

Compare: Electricity Governance Rules 2003 rule 3.1.4 section II part F

Clause 12.11: amended, on 1 October 2023, by clause 9 of the Electricity Industry Participation Code Amendment (Default Transmission Agreement) 2023.

12.12 Changes to connection assets under default transmission agreements

- (1) If **Transpower** reconfigures, replaces, enhances, or permanently removes a **connection asset** from service in accordance with the provisions of a **default transmission agreement**—
 - (a) within 20 **business days**, to the extent necessary, **Transpower** must provide the **designated transmission customer** who is a party to that agreement with a revised Schedules 1 and 2, a revised Schedule 4, and a revised Schedule 5, and a revised Schedule 6 for that agreement, reflecting any changes to the description of the **connection locations, points of service, or points of connection** in Schedules 1 and 2, the diagram in Schedule 4, the service levels specified in Schedule 5, or the information in Schedule 6 resulting from the replacement or enhancement of the **connection asset**; and
 - (b) the **designated transmission customer** and **Transpower** may discuss the revised schedules, as a result of which **Transpower** may amend any of the revised schedules; and
 - (c) the **designated transmission customer** must advise **Transpower** within 20 **business days** of receiving the revised schedules under paragraph (a) whether—
 - (i) it accepts the revised schedules as proposed by **Transpower** under paragraph (a); or
 - (ii) if **Transpower** has amended any of those revised schedules under paragraph (b), it accepts the revised schedules as amended; and
 - (d) the revised schedules apply under the **default transmission agreement** from the date that acceptance is received by **Transpower** under paragraph (c).
- (2) If the **designated transmission customer** does not accept the revised schedules under subclause (1)(c), either party may refer the matter to the **Rulings Panel** for determination under clauses 12.45 to 12.48.
- (3) If a dispute is referred to the **Rulings Panel** in accordance with subclause (2)—
 - (a) the revised schedules proposed by **Transpower** under subclause (1)(a) apply from the date on which **Transpower** provides the **designated transmission customer** with the revised schedules under subclause (1)(a) until the date on which the **Rulings Panel** makes its determination or the determination comes into effect; and
 - (b) the revised schedules as determined by the **Rulings Panel** under clauses 12.45 to 12.48 apply under the **default transmission agreement** from the date determined by the **Rulings Panel**.

Compare: Electricity Governance Rules 2003 rule 3.1.5 section II part F
Clause 12.12: amended, on 1 October 2023, by clause 10(1) of the Electricity Industry Participation Code Amendment (Default Transmission Agreement) 2023. Clause 12.12(1) and (1)(a): amended, on 1 October 2023, by clause 10(2) and 10(3) of the Electricity Industry Participation Code Amendment (Default Transmission Agreement) 2023.

12.13 Expiry or termination of transmission agreements

If a **participant** and **Transpower** are party to an existing **transmission agreement** or written agreement to which clause 12.49 applies, and do not enter into a new **transmission agreement** before the existing agreement expires or terminates, upon expiry or termination of the existing agreement the provisions in clause 12.10 apply

with all necessary modifications.

Compare: Electricity Governance Rules 2003 rule 3.1.6 section II part F

Clause 12.13: amended, on 1 October 2023, by clause 11(1) and 11(2) of the Electricity Industry Participation Code Amendment (Default Transmission Agreement) 2023.

Clause 12.13(a)(ii) and (b)(ii): amended, on 5 October 2017, by clause 288 of the Electricity Industry Participation Code Amendment (Code Review Programme) 2017.

Clause 12.13(b)(v): amended, on 1 October 2023, by clause 11(3) of the Electricity Industry Participation Code Amendment (Default Transmission Agreement) 2023.

Clause 12.13(e): amended, on 1 October 2023, by clause 11(4) of the Electricity Industry Participation Code Amendment (Default Transmission Agreement) 2023.

Clause 12.13(g)(i): amended, on 1 October 2023, by clause 11(5) of the Electricity Industry Participation Code Amendment (Default Transmission Agreement) 2023.

Clause 12.13(g)(ii): amended, on 1 October 2023, by clause 11(6) of the Electricity Industry Participation Code Amendment (Default Transmission Agreement) 2023.

Clause 12.13: replaced, on 1 March 2024, by clause 56 of the Electricity Industry Participation Code Amendment (Code Review Programme) 2024.

Content of transmission agreements

12.14 Transmission agreements to be consistent with default transmission agreement template and grid reliability standards

Subject to clauses 12.35 to 12.38, a **transmission agreement** entered into between **Transpower** and a **designated transmission customer** under clause 12.8 must be consistent in all material respects with—

- (a) the **default transmission agreement template**; and
- (b) the **grid reliability standards**,—

as at the date the **transmission agreement** is entered into.

Compare: Electricity Governance Rules 2003 rule 3.2.1 section II part F

Clause 12.14 Heading: amended, on 1 October 2023, by clause 12(1) of the Electricity Industry Participation Code Amendment (Default Transmission Agreement) 2023.

Clause 12.14(a): amended, on 1 October 2023, by clause 12(2) of the Electricity Industry Participation Code Amendment (Default Transmission Agreement) 2023.

12.15 Transpower to publish information about transmission agreements and provide them on request

- (1) **Transpower** must **publish** and update annually a list of all **transmission agreements** it has with **designated transmission customers** that includes, in respect of each **transmission agreement** contained in the list, the following information:

- (a) the full name of the **designated transmission customer** that is a party to the **transmission agreement**; and
- (b) the date on which the **transmission agreement** was executed; and
- (c) whether the **transmission agreement** includes any material variations from the **default transmission agreement**; and
- (d) if the **transmission agreement** includes any material variations from the **default transmission agreement**; a description of the variations; and
- (e) if any schedule to the **transmission agreement** has been revised in accordance with clause 12.12, the date from which the revised schedule began to apply.

- (2) A person may request from **Transpower** a copy of a **transmission agreement** that **Transpower** has with a **designated transmission customer**, and **Transpower** must provide a copy to the person as soon as practicable after receiving the request.
- (3) Despite subclause (2), **Transpower** may refuse to provide information from a **transmission agreement** if it considers that there would be grounds for withholding the information under the Official Information Act 1982.
Compare: Electricity Governance Rules 2003 rule 3.2.2 section II part F
Clause 12.15: substituted, on 1 February 2016, by clause 46 of the Electricity Industry Participation Code Amendment (Code Review Programme) 2015.
Clause 12.15(1): amended, on 1 October 2023, by clause 13 of the Electricity Industry Participation Code Amendment (Default Transmission Agreement) 2023.

Connection Code

12.16 Connection Code [Revoked]

Clause 12.16: revoked, on 1 October 2023, by clause 14 of the Electricity Industry Participation Code Amendment (Default Transmission Agreement) 2023.

12.17 Purpose of Connection Code

The purpose of the **Connection Code** is to set out the technical requirements and standards that **designated transmission customers** must meet in order to be connected to the **grid** and that **Transpower** and **designated transmission customers** must comply with under **transmission agreements**.

Compare: Electricity Governance Rules 2003 rule 3.3.1 section II part F
Clause 12.17: amended, on 23 February 2015, by clause 75 of the Electricity Industry Participation Code Amendment (Distributed Generation) 2014.
Clause 12.17: amended, on 5 October 2017, by clause 289 of the Electricity Industry Participation Code Amendment (Code Review Programme) 2017.
Clause 12.17: amended, on 1 October 2023, by clause 15 of the Electricity Industry Participation Code Amendment (Default Transmission Agreement) 2023.

12.18 Review of Connection Code

- (1) The **Authority** may review the **Connection Code** at any time.
- (2) Clauses 12.19 to 12.25 apply to any such review.
Compare: Electricity Governance Rules 2003 rule 3.3.10 section II part F

12.19 Transpower to submit Connection Code

- (1) **Transpower** must submit a proposed **Connection Code** to the **Authority** within 90 days (or such longer period as the **Authority** may allow) of receipt of a written request from the **Authority**. The **Authority** may issue such a request at any time. The proposed **Connection Code** must provide for the matters set out in clause 12.20 and give effect to the principles set out in clause 12.21.
- (2) With its proposed **Connection Code**, **Transpower** must submit to the **Authority** an explanation of the proposed **Connection Code** and a **statement of proposal** for the proposed **Connection Code**.
Compare: Electricity Governance Rules 2003 rule 3.3.2 section II part F

12.20 Required content of Connection Code

The **Connection Code** must provide for the following matters:

- (a) connection requirements for **designated transmission customers**:

- (b) technical requirements for **assets**, including **assets** owned by **Transpower**, and for other equipment and plant that is connected to a **local network** or an **embedded network** or that forms part of an **embedded network** or **embedded generating station** if the operation of that equipment and plant could affect the **grid assets**:
- (c) operating standards for equipment that is owned by a **designated transmission customer**, used in relation to the conveyance of **electricity**, and that is situated on land owned by **Transpower**:
- (d) information requirements to be met by **designated transmission customers** before equipment is connected to the **grid** and before changes are made to the equipment:
- (e) an obligation on **Transpower** to provide a 10 year forecast of the expected maximum fault level of each point of service to **designated transmission customers** set out in the **transmission agreement** between **Transpower** and each **designated transmission customer**.

Compare: Electricity Governance Rules 2003 rule 3.3.3 section II part F

Clause 20.20: amended, on 23 February 2015, by clause 75 of the Electricity Industry Participation Code Amendment (Distributed Generation) 2014.

Clause 12.20(a): amended, on 5 October 2017, by clause 290(1) of the Electricity Industry Participation Code Amendment (Code Review Programme) 2017.

Clause 12.20(b) and (d): amended, on 5 October 2017, by clause 290(2) of the Electricity Industry Participation Code Amendment (Code Review Programme) 2017.

Clause 12.20(c): amended, on 5 October 2017, by clause 290(3) of the Electricity Industry Participation Code Amendment (Code Review Programme) 2017.

Clause 12.20(e): amended, on 5 October 2017, by clause 290(4) of the Electricity Industry Participation Code Amendment (Code Review Programme) 2017.

12.21 Principles for developing Connection Code

The **Connection Code** must give effect to the following principles:

- (a) the principles of the **default transmission agreement template** in clause 12.30:
- (b) the desirability of the **Connection Code** and Part 8 operating in an integrated and consistent manner, if possible:
- (c) the need to ensure that the **grid owner** can meet all obligations placed on it by the **system operator** for the purpose of meeting common security and power quality requirements under Part 8:
- (d) the need to ensure that the safety of all personnel is maintained:
- (e) the need to ensure that the safety and integrity of equipment is maintained.

Compare: Electricity Governance Rules 2003 rule 3.3.4 section II part F

Clause 12.21: amended, on 1 October 2023, by clause 16 of the Electricity Industry Participation Code Amendment (Default Transmission Agreement) 2023.

12.22 Authority may initially approve proposed Connection Code or refer back to Transpower

- (1) After consideration of **Transpower's** proposed **Connection Code**, and accompanying explanation and **statement of proposal**, the **Authority** may—
 - (a) provisionally approve the proposed **Connection Code** having regard to the matters set out in clause 12.20 and the principles in clause 12.21; or
 - (b) refer the proposed **Connection Code** and accompanying explanation and **statement of proposal** back to **Transpower** if, in the **Authority's** view,—

- (i) the proposed **Connection Code** does not contain the matters set out in clause 12.20; or
 - (ii) the proposed **Connection Code** does not adequately provide for the principles in clause 12.21; or
 - (iii) the explanation or **statement of proposal** provided with the proposed **Connection Code** in accordance with clause 12.19(2) is inadequate.
- (2) **Transpower** may, no later than 20 **business days** (or such longer period as the **Authority** may allow) after the **Authority** advises **Transpower** of its decision under subclause (1), consider the **Authority's** concerns and resubmit its proposed **Connection Code** and accompanying explanation and **statement of proposal** for consideration by the **Authority**.

Compare: Electricity Governance Rules 2003 rule 3.3.5 section II part F

Clause 12.22(2): amended, on 1 November 2018, by clause 74 of the Electricity Industry Participation Code Amendment (Code Review Programme) 2018.

12.23 Amendment of proposed Connection Code by Authority

If the **Authority** considers that the **Connection Code** resubmitted by **Transpower** under clause 12.22(b) does not adequately provide for the matters set out in clause 12.20 or adequately give effect to the principles in clause 12.21, the **Authority** may make any amendments to the proposed **Connection Code** it considers necessary.

Compare: Electricity Governance Rules 2003 rule 3.3.6 section II part F

12.24 Authority must consult on proposed Connection Code

- (1) The **Authority** must **publish** the proposed **Connection Code**, either as provisionally approved by the **Authority** or as amended by the **Authority**, as soon as practicable, for consultation with any person that the **Authority** thinks is likely to be materially affected by the proposed **Connection Code**.
- (2) As well as the consultation required under subclause (1), the **Authority** may undertake any other consultation it considers necessary.

Compare: Electricity Governance Rules 2003 rules 3.3.7 and 3.3.8 section II part F

12.25 Decision on Connection Code

When the **Authority** has completed its consultation on the proposed **Connection Code** it must decide whether to amend the **Connection Code**.

Compare: Electricity Governance Rules 2003 rule 3.3.9 section II part F

Clause 12.25(2): amended, on 1 August 2023, by clause 41 of the Electricity Industry Participation Code Amendment (System Operation Documents) 2023.

Clause 12.25(1) and 12.25(2): amended, on 1 October 2023, by clause 17 of the Electricity Industry Participation Code Amendment (Default Transmission Agreement) 2023.

12.26 Incorporation of Connection Code by reference *[Revoked]*

Clause 12.26(1): amended, on 5 October 2017, by clause 291 of the Electricity Industry Participation Code Amendment (Code Review Programme) 2017.

Clause 12.26(1): amended, on 1 August 2023, by clause 42(1) of the Electricity Industry Participation Code Amendment (System Operation Documents) 2023.

Clause 12.26(2): revoked, on 1 August 2023, by clause 42(2) of the Electricity Industry Participation Code Amendment (System Operation Documents) 2023.

Clause 12.26: revoked, on 1 October 2023, by clause 18 of the Electricity Industry Participation Code Amendment (Default Transmission Agreement) 2023.

Default transmission agreement template

Cross heading: amended, on 1 October 2023, by clause 19 of the Electricity Industry Participation Code Amendment (Default Transmission Agreement) 2023.

12.27 Benchmark agreement [Revoked]

Clause 12.27(1)(e): amended, on 1 February 2016, by clause 47 of the Electricity Industry Participation Code Amendment (Code Review Programme) 2015.

Clause 12.27: revoked, on 1 October 2023, by clause 20 of the Electricity Industry Participation Code Amendment (Default Transmission Agreement) 2023.

12.28 Authority may initiate review [Revoked]

Compare: Electricity Governance Rules 2003 rule 7 section II part F

Clause 12.28: revoked, on 1 October 2023, by clause 20 of the Electricity Industry Participation Code Amendment (Default Transmission Agreement) 2023.

12.29 Purpose of default transmission agreement template

The purpose of **default transmission agreement template** is to—

- (a) facilitate commercial arrangements between **Transpower** and **designated transmission customers** by providing a basis for negotiating **transmission agreements** required under clause 12.8 that meet the particular requirements of **Transpower** and **designated transmission customers**; and
- (b) provide the basis for **default transmission agreements**

Compare: Electricity Governance Rules 2003 rule 4.1 section II part F

Clause 12.29 heading and clause: amended, on 1 October 2023, by clause 21(1) and (2) of the Electricity Industry Participation Code Amendment (Default Transmission Agreement) 2023.

Clause 12.29(b): amended, on 1 October 2023, by clause 21(3) of the Electricity Industry Participation Code Amendment (Default Transmission Agreement) 2023.

12.30 Principles for default transmission agreement template

The **default transmission agreement template** should—

- (a) reflect a fair and reasonable balance between the requirements of **designated transmission customers** and the legitimate interests of **Transpower** as **asset owner**; and
- (b) reflect the interests of end use customers; and
- (c) reflect the reasonable requirements of **designated transmission customers** at the **grid injection points** and **grid exit points**, and the ability of **Transpower** to meet those requirements; and
- (d) reflect the differing needs of different classes of **designated transmission customers**; and
- (e) be appropriate to the technical requirements of services provided at the **point of connection** to the **grid**, but not duplicate requirements that are more appropriately included in the **grid reliability standards**; and
- (f) establish common standards for a common configuration based on factors such as size of connection and voltage level; and
- (g) encourage efficient and effective processes for enforcement of obligations and dispute resolution.

Compare: Electricity Governance Rules 2003 rule 4.2 section II part F

Clause 12.30(f): amended, on 23 February 2015, by clause 75 of the Electricity Industry Participation Code Amendment (Distributed Generation) 2014.

Clause 12.30(f): amended, on 5 October 2017, by clause 292 of the Electricity Industry Participation Code Amendment (Code Review Programme) 2017.

Clause 12.30 heading and clause: amended, on 1 October 2023, by clause 22(1) and (2) of the Electricity Industry Participation Code Amendment (Default Transmission Agreement) 2023.

12.31 Contents of default transmission agreement template

- (1) The **default transmission agreement template** must include—
- (a) an obligation on the parties to design, construct, maintain and operate all relevant plant and equipment in accordance with—
 - (i) relevant laws; and
 - (ii) the requirements of this Code (including obligations on **designated transmission customers** to provide information to facilitate system planning, as set out in clause 12.54); and
 - (iii) **good electricity industry practice** and applicable New Zealand technical and safety standards; and
 - (b) an obligation on **designated transmission customers** to comply with **Transpower's** reasonable technical connection and safety requirements; and
 - (c) an obligation on **designated transmission customers** to pay prices calculated in accordance with the **transmission pricing methodology** approved by the **Authority** under subpart 4; and
 - (d) arbitration or mediation processes for resolving disputes; and
 - (e) service definitions, service levels, and service measures to the extent practicable for transmission services, other than the services to which the clauses in subpart 6 apply; and
 - (f) the charging of a fee by **Transpower** to recover its **settlement residue** processing costs from **designated transmission customers**; and
 - (g) the recovery of any negative **settlement residue** by **Transpower** from **designated transmission customers**.
- (2) The **default transmission agreement template** must be consistent in all material respects with the **grid reliability standards**.

Compare: Electricity Governance Rules 2003 rule 4.3 section II part F

Clause 12.31(1)(b): amended, on 23 February 2015, by clause 75 of the Electricity Industry Participation Code Amendment (Distributed Generation) 2014.

Clause 12.31(1)(b): amended, on 5 October 2017, by clause 293 of the Electricity Industry Participation Code Amendment (Code Review Programme) 2017.

Clause 12.31 heading: amended, on 1 October 2023, by clause 23(1) of the Electricity Industry Participation Code Amendment (Default Transmission Agreement) 2023.

Clause 12.31(1) and (1)(e): amended, on 1 October 2023, by clause 23(2) and (3) of the Electricity Industry Participation Code Amendment (Default Transmission Agreement) 2023.

Clause 12.31(1)(f) and (g): inserted, on 1 October 2023, by clause 23(4) of the Electricity Industry Participation Code Amendment (Default Transmission Agreement) 2023.

Clause 12.31(2): amended, on 1 October 2023, by clause 23(5) of the Electricity Industry Participation Code Amendment (Default Transmission Agreement) 2023.

12.32 Authority must consult on draft benchmark agreement *[Revoked]*

Compare: Electricity Governance Rules 2003 rules 4.4 and 4.5 section II part F

Clause 12.32(2): amended, on 1 November 2018, by clause 75 of the Electricity Industry Participation Code Amendment (Code Review Programme) 2018.

Clause 12.32: revoked, on 1 October 2023, by clause 24 of the Electricity Industry Participation Code Amendment (Default Transmission Agreement) 2023.

12.33 Decision on benchmark agreement *[Revoked]*

Compare: Electricity Governance Rules 2003 rule 4.6 section II part F

Clause 12.33(2): amended, on 1 August 2023, by clause 43 of the Electricity Industry Participation Code Amendment (System Operation Documents) 2023.

Clause 12.33: revoked, on 1 October 2023, by clause 24 of the Electricity Industry Participation Code Amendment (Default Transmission Agreement) 2023.

12.34 Incorporation of benchmark agreement by reference *[Revoked]*

Clause 12.34(1): amended, on 5 October 2017, by clause 294 of the Electricity Industry Participation Code Amendment (Code Review Programme) 2017.

Clause 12.34(1): amended, on 1 August 2023, by clause 44(1) of the Electricity Industry Participation Code Amendment (System Operation Documents) 2023.

Clause 12.34(2): revoked, on 1 August 2023, by clause 44(2) of the Electricity Industry Participation Code Amendment (System Operation Documents) 2023.

Clause 12.34: revoked, on 1 October 2023, by clause 24 of the Electricity Industry Participation Code Amendment (Default Transmission Agreement) 2023.

Variations from default transmission agreement template and grid reliability standards and enhancement and removal of connection assets

Cross heading: amended, on 1 October 2023, by clause 25 of the Electricity Industry Participation Code Amendment (Default Transmission Agreement) 2023.

12.35 Increased service levels and reliability

(1) This clause applies if—

- (a) a proposed **transmission agreement** is not consistent in all material respects with the **default transmission agreement template** because it increases the service levels above those in the template; or
- (b) subject to clause 12.39, a proposed **transmission agreement** or other agreement between **Transpower** and a **designated transmission customer** increases the level of reliability above the **grid reliability standards** for a particular **grid injection point** or **grid exit point**.

(2) If this clause applies, the parties to the proposed **transmission agreement** must confirm in writing to the **Authority** that—

- (a) they have consulted with affected end use customers in relation to—
 - (i) the proposed service levels or the proposed increase in reliability; and
 - (ii) any resulting price implications; and
- (b) there are no material unresolved issues affecting the interests of those end use customers.

Compare: Electricity Governance Rules 2003 rule 5.1 section II part F

Clause 12.35 Heading: amended, on 15 May 2014, by clause 32(a) of the Electricity Industry Participation (Minor Code Amendments) Code Amendment 2014.

Clause 12.35(1)(a): amended, on 15 May 2014, by clause 32(b) of the Electricity Industry Participation (Minor Code Amendments) Code Amendment 2014.

Clause 12.35(1)(a): amended, on 1 October 2023, by clause 26 of the Electricity Industry Participation Code Amendment (Default Transmission Agreement) 2023.

Clause 12.35(2): replaced, on 5 October 2017, by clause 295 of the Electricity Industry Participation Code Amendment (Code Review Programme) 2017.

12.36 Decreased service levels and reliability

(1) This clause applies if—

- (a) a proposed **transmission agreement** is not consistent in all material respects with the **default transmission agreement template** because it decreases the service levels below those in the template; or
 - (b) subject to clause 12.39, a proposed **transmission agreement** or other agreement between **Transpower** and a **designated transmission customer** decreases the level of reliability below the **grid reliability standards** for a particular **grid injection point** or **grid exit point**.
- (2) If this clause applies, the parties must obtain the **Authority's** approval of the proposed service levels or the lower level of reliability.
- (3) The parties must satisfy the **Authority** that the **Authority** should grant an approval under subclause (2), having regard to any potential material adverse impacts of the proposed service levels or the lower level of reliability on—
- (a) current and future service levels or reliability for any affected **designated transmission customer** or end use customer; and
 - (b) the price paid for transmission or distribution services, or **electricity**, by any affected **designated transmission customer** or end use customer.

Compare: Electricity Governance Rules 2003 rule 5.2 section II part F

Clause 12.36 Heading: amended, on 15 May 2014, by clause 33(a) of the Electricity Industry Participation (Minor Code Amendments) Code Amendment 2014.

Clause 12.36(1)(a): amended, on 15 May 2014, by clause 33(b) of the Electricity Industry Participation (Minor Code Amendments) Code Amendment 2014.

Clause 12.36(1)(a): amended, on 1 October 2023, by clause 27 of the Electricity Industry Participation Code Amendment (Default Transmission Agreement) 2023.

12.37 Variations that may increase or decrease reliability

If it is uncertain whether, subject to clause 12.39, a proposed **transmission agreement** or other agreement increases or decreases the service levels from those that would apply if the **default transmission agreement template** applied, or whether a proposed **transmission agreement** or other agreement increases or decreases the level of reliability above or below the **grid reliability standards**, for a particular **grid injection point** or **grid exit point**, the parties must obtain the **Authority's** approval described in clause 12.36(2).

Compare: Electricity Governance Rules 2003 rule 5.3 section II part F

Clause 12.37: amended, on 1 October 2023, by clause 28 of the Electricity Industry Participation Code Amendment (Default Transmission Agreement) 2023.

12.38 Other variations from terms of default transmission agreement template

- (1) This clause applies if a proposed **transmission agreement** to be entered into by **Transpower** and a **designated transmission customer** under clause 12.8 is not consistent in all material aspects with the **default transmission agreement template**, other than a situation to which clauses 12.35 to 12.37 apply.
- (2) If this clause applies, the parties must obtain the **Authority's** approval to the proposed variation from the **default transmission agreement template**. The parties to the proposed **transmission agreement** must satisfy the **Authority** that they have consulted with any affected end use customers and **designated transmission customers** in relation to the proposed variation, and there are no material unresolved issues affecting the interests of those persons.

Compare: Electricity Governance Rules 2003 rule 5.4 section II part F

Clause 12.38 heading: amended, on 1 October 2023, by clause 29(1) of the Electricity Industry Participation Code Amendment (Default Transmission Agreement) 2023.

Clause 12.38: amended, on 1 October 2023, by clause 29(2) of the Electricity Industry Participation Code Amendment (Default Transmission Agreement) 2023.

12.39 Customer specific value of expected unserved energy

- (1) *[Revoked]*
- (2) **Transpower** or a **designated transmission customer** may apply to the **Authority**—
 - (a) if permitted under a **transmission agreement**, for provisional approval to use a different **value of expected unserved energy** than the value specified in clause 4 of Schedule 12.2 for the purposes of determining whether to replace or enhance **connection assets** as provided for under that **transmission agreement**; or
 - (b) for approval to use a different **value of expected unserved energy** than the value specified in clause 4 of Schedule 12.2 for the purposes of applying the **grid reliability standards** under clauses 12.35 to 12.37 for a **grid injection point** or **grid exit point**, regardless of whether **Transpower** or the **designated transmission customer** has applied for the **Authority's** provisional approval under subclause (4).
- (3) An application under subclause (2) must be made in writing to the **Authority**—
 - (a) in the case of an application under subclause (2)(a), within 20 **business days** of the **designated transmission customer** proposing that different value to **Transpower** under the **transmission agreement**; and
 - (b) in the case of an application under subclause (2)(b), within 20 **business days** of the **designated transmission customer** reaching an agreement with **Transpower** to which clauses 12.35 to 12.37 apply.
- (4) If **Transpower** or a **designated transmission customer** applies for approval of a different **value of expected unserved energy** under subclause (2)(a), the **Authority** may provisionally approve that value if the **Authority** considers that the value is a reasonable estimate of the **value of expected unserved energy** in respect of the **grid injection point** or **grid exit point** for the **designated transmission customer** concerned.
- (5) If **Transpower** or a **designated transmission customer** applies for approval of a different **value of expected unserved energy** under subclause (2)(b) the **Authority**—
 - (a) may approve that value if the **Authority** considers that the value is a reasonable estimate of the **value of expected unserved energy** in respect of the **grid injection point** or **grid exit point** for the **designated transmission customer** concerned; and
 - (b) may decline to approve that value despite having provisionally approved that value under subclause (4).
- (6) If the **Authority** approves the **value of expected unserved energy** proposed by **Transpower** or the **designated transmission customer** under subclause (2)(b), that **value of expected unserved energy** applies for the purposes of applying the **grid reliability standards** under clauses 12.35 to 12.37 for the **grid injection point** or **grid exit point** instead of the **value of expected unserved energy** specified under clause 4 of Schedule 12.2.

- (7) If the **Authority** does not approve the **value of expected unserved energy** proposed by **Transpower** or the **designated transmission customer** under subclause (2)(b), the **value of expected unserved energy** under clause 4 of Schedule 12.2 applies for the purposes of applying the **grid reliability standards** under clauses 12.35 to 12.37 for the **grid injection point** or **grid exit point**.

Compare: Electricity Governance Rules 2003 rule 5.5 section II part F

Clause 12.39 Heading: amended, on 1 February 2016, by clause 48(1) of the Electricity Industry Participation Code Amendment (Code Review Programme) 2015.

Clause 12.39: amended, on 1 February 2016, by clause 48(3) of the Electricity Industry Participation Code Amendment (Code Review Programme) 2015.

Clause 12.39(1): revoked, on 1 February 2016, by clause 48(2) of the Electricity Industry Participation Code Amendment (Code Review Programme) 2015.

Clause 12.39(2)(b): amended, on 1 February 2016, by clause 48(4) of the Electricity Industry Participation Code Amendment (Code Review Programme) 2015.

Clause 12.39(4): amended, on 1 February 2016, by clause 48(5) of the Electricity Industry Participation Code Amendment (Code Review Programme) 2015.

Clause 12.39(6): amended, on 1 February 2016, by clause 48(6) and (7) of the Electricity Industry Participation Code Amendment (Code Review Programme) 2015.

Clause 12.39(7): amended, on 1 February 2016, by clause 48(8) of the Electricity Industry Participation Code Amendment (Code Review Programme) 2015.

12.40 Replacement and enhancement of shared connection assets

- (1) If 2 or more **designated transmission customers** are connected to a **point of connection** and **Transpower** has advised those **designated transmission customers**, in accordance with the provisions of a **transmission agreement** between **Transpower** and each of the **designated transmission customers**, that a **grid reliability report published** by **Transpower** in accordance with clause 12.76 sets out that the power system is not reasonably expected to meet the **N-1 criterion** at all times over the next 5 years because of a **connection asset** related to that **point of connection**, **Transpower** must—
- (a) as soon as practicable after advising the **designated transmission customers**, investigate whether the **connection asset** meets the **grid reliability standards**; and
 - (b) if it finds that the **connection asset** does not meet the **grid reliability standards**, develop proposals for investment in the **grid** to ensure that the **connection asset** meets the **grid reliability standards** and propose them to the **designated transmission customers** as soon as reasonably possible after **publication** of the **grid reliability report**.
- (2) **Transpower** and the **designated transmission customers** advised under subclause (1) must attempt in good faith, within 6 months of the date on which **Transpower** makes its proposals to the **designated transmission customers** under subclause (1)(b), or such longer period as the **Authority** may allow, to reach an agreement for an investment or other solution that will have the effect of—
- (a) maintaining the level of reliability for the **connection asset** at the level of reliability in the **grid reliability standards**; or
 - (b) increasing or decreasing the level of reliability for the **connection asset** above or below the **grid reliability standards**, so long as **Transpower** and the **designated transmission customers** have complied with clauses 12.35 to 12.37 and 12.39.
- (3) **Transpower** may undertake an investment proposed under subclause (2) only—

- (a) if the **designated transmission customers** unanimously agree with the proposal in accordance with subclause (2); or
- (b) if the **designated transmission customers** do not unanimously agree or none of the **designated transmission customers** agree with the proposed investment, if—
 - (i) the proposal has been approved under a grid upgrade plan requested by the Electricity Commission in accordance with rule 5.10 of section II of part F of the **rules** before this Code came into force; or
 - (ii) the proposal is approved by the Commerce Commission under an investment proposal requested by the Commerce Commission in accordance with clause 12.44(1); or
 - (iii) the proposal is permitted under an input methodology determined by the Commerce Commission under section 54S of the Commerce Act 1986.

Compare: Electricity Governance Rules 2003 rule 5.6 section II part F

Clause 12.40(1): amended, on 23 February 2015, by clause 75 of the Electricity Industry Participation Code Amendment (Distributed Generation) 2014.

Clause 12.40(1): amended, on 5 October 2017, by clause 296 of the Electricity Industry Participation Code Amendment (Code Review Programme) 2017.

Clause 12.40(1) and (2): amended, on 1 November 2018, by clause 76(a) and (b) of the Electricity Industry Participation Code Amendment (Code Review Programme) 2018.

12.41 Removal of shared connection assets from service

- (1) If 2 or more **designated transmission customers** are connected to a **point of connection**, and **Transpower** is required by a **transmission agreement** between **Transpower** and each of those **designated transmission customers** to provide the **connection assets** at the **point of connection**, **Transpower** may **decommission a connection asset** at that **point of connection** from service only—
 - (a) if the **designated transmission customers** unanimously agree with the **decommissioning** and clauses 12.35 to 12.37 (if applicable) are complied with; or
 - (b) if the **designated transmission customers** do not unanimously agree, or none of the **designated transmission customers** agree, with the **decommissioning**, if the **decommissioning** results in a net benefit, as calculated under the test set out in clause 12.43.
- (2) To avoid doubt, this clause applies only if **Transpower** proposes to remove a **connection asset** from service and not replace the **asset** with another **connection asset**.

Compare: Electricity Governance Rules 2003 rule 5.7 section II part F

Clause 12.41(1): amended, on 23 February 2015, by clause 75 of the Electricity Industry Participation Code Amendment (Distributed Generation) 2014.

Clause 12.41(1): amended, on 5 October 2017, by clause 297 of the Electricity Industry Participation Code Amendment (Code Review Programme) 2017.

12.42 Reconfiguration of shared connection assets

If 2 or more **designated transmission customers** are connected to a **point of connection**, and **Transpower** is required by a **transmission agreement** between **Transpower** and each of those **designated transmission customers** to provide the **connection assets** in the configuration specified in each of those **transmission agreements**, **Transpower** may only change that configuration—

- (a) if the **designated transmission customers** unanimously agree with the reconfiguration and clauses 12.35 to 12.37 (if applicable) are complied with; or

- (b) if the **designated transmission customers** do not unanimously agree, or none of the **designated transmission customers** agree with the reconfiguration, if the reconfiguration results in a net benefit, as calculated under the test set out in clause 12.43.

Compare: Electricity Governance Rules 2003 rule 5.8 section II part F

Clause 12.42: amended, on 23 February 2015, by clause 75 of the Electricity Industry Participation Code Amendment (Distributed Generation) 2014.

Clause 12.42: amended, on 5 October 2017, by clause 298 of the Electricity Industry Participation Code Amendment (Code Review Programme) 2017.

12.43 Net benefits test

- (1) When **Transpower** is required to apply a net benefit test, **Transpower** must—
- (a) estimate the following costs:
- (i) any additional fuel costs incurred by a **generator** in respect of any **generating units** that will be **dispatched** or are likely to be **dispatched** during or after the removal of the **connection asset** or the reconfiguration of the **connection assets**, arising as a result of the removal or reconfiguration:
 - (ii) any direct labour and material costs that will be incurred by **Transpower** and the **designated transmission customers** undertaking the removal of the **connection asset** or the reconfiguration of the **connection assets**:
 - (iii) any increase in the estimate of **expected unserved energy** in MWh multiplied by the value per MWh of that **expected unserved energy**, arising as a result of the removal of the **connection asset** or the reconfiguration of the **connection assets**:
 - (iv) any of the following costs, if the cost is to a person that produces, transmits, retails, or consumes **electricity** in New Zealand:
 - (A) changes in fuel costs of **existing assets, committed projects and modelled projects**:
 - (B) changes in the value of involuntary **demand** curtailment:
 - (C) changes in the costs of **demand**-side management:
 - (D) changes in costs resulting from deferral of capital expenditure on **modelled projects**:
 - (E) changes in costs resulting from differences in the amount of capital expenditure on **modelled projects**:
 - (F) changes in costs resulting from differences in operations and maintenance expenditure on **existing assets, committed projects, and modelled projects**:
 - (G) changes in costs for **ancillary services**:
 - (H) changes in **losses**, including **local losses**:
 - (I) subsidies or other benefits provided under or arising pursuant to all applicable laws, regulations and administrative determinations:
 - (J) the value of the expected change in economic surplus due to a change in competition among **participants** arising as a result of the removal of the **connection asset** or the reconfiguration of the **connection assets**, excluding any expected change in economic surplus due to a change in another cost in this net benefit test:

- (v) any other relevant cost to a person that produces, transmits, retails or consumes **electricity** in New Zealand; and
 - (b) estimate the following benefits:
 - (i) any reduction in maintenance costs arising as a result of the removal of the **connection asset** or the reconfiguration of the **connection assets** (including **Transpower's** and any **designated transmission customer's** costs):
 - (ii) any reduction in fuel costs incurred by a **generator** in respect of any **generating units**, arising or likely to arise during or after the removal of the **connection asset** or the reconfiguration of the **connection assets**, as a result of the removal or reconfiguration:
 - (iii) any decrease in the estimate of **expected unserved energy** in MWh multiplied by the value per MWh of that **expected unserved energy**, arising as a result of the removal of the **connection asset** or the reconfiguration of the **connection assets**:
 - (iv) any of the following benefits, if the benefit is to a person that produces, transmits, retails or consumes **electricity** in New Zealand:
 - (A) changes in fuel costs of **existing assets, committed projects and modelled projects**:
 - (B) changes in the value of involuntary **demand** curtailment:
 - (C) changes in the costs of **demand**-side management:
 - (D) changes in costs resulting from the deferral of capital expenditure on **modelled projects**:
 - (E) changes in costs resulting from differences in the amount of capital expenditure on **modelled projects**:
 - (F) changes in costs resulting from differences in operations and maintenance expenditure on **existing assets, committed projects, and modelled projects**:
 - (G) changes in costs for **ancillary services**:
 - (H) changes in **losses**, including **local losses**:
 - (I) subsidies or other benefits provided under or arising pursuant to all applicable laws, regulations and administrative determinations:
 - (J) the value of the expected change in economic surplus due to a change in competition among **participants** arising as a result of the removal of the **connection asset** or the reconfiguration of the **connection assets**, excluding any expected change in economic surplus due to a change in another benefit in this net benefit test:
 - (v) any other relevant benefit to a person that produces, transmits, retails or consumes **electricity** in New Zealand; and
 - (c) deduct the costs estimated under paragraph (a) from the benefits estimated under paragraph (b) to determine the net benefit of the proposed removal of the **connection asset** or the reconfiguration of the **connection assets**.
- (2) **Transpower** may apply the test under this clause at differing levels of rigour in different circumstances, which may include taking into account the number of **assets** to

- be removed or reconfigured, the value of the **assets** involved, and the size of the load served by the **assets**.
- (3) **Transpower** is only required to—
- (a) make a reasonable estimate of the costs and benefits identified in subclause (1), based on information reasonably available to it at the time it undertakes the test, and taking into account the proposed number of **assets** to be removed or reconfigured, the value of the **assets** involved, and the size of the load served by the **assets**; and
 - (b) take account of events that can be reasonably foreseen.
- (4) **Transpower's** estimate of fuel costs under subclause (1) must—
- (a) in relation to thermal **generating stations**, be a reasonable estimate of the fuel costs, based on the economic value of the fuel required for the relevant thermal **generating station**, and justified by **Transpower** with reference to opinions on the economic value of the fuel, provided by 1 or more independent and suitably qualified persons; and
 - (b) in relation to hydroelectric **generating stations**—
 - (i) be a reasonable estimate of the fuel costs, based on the economic value of the water stored at a hydroelectric **generating station**, provided by a suitably qualified person other than—
 - (A) **Transpower**; or
 - (B) an employee of **Transpower**; and
 - (ii) be **published**, as provided for in the **Outage Protocol**.
- (5) The direct labour costs of **Transpower** and **designated transmission customers** under subclause (1)(a) may include any amounts paid to contractors, but must not include any apportionment of the overheads or office costs of **Transpower** or **designated transmission customers**.
- (6) The material costs of **Transpower** and **designated transmission customers** under subclause (1)(a) are the costs of the materials used in carrying out the work during the removal of the **connection asset** or the reconfiguration of the **connection assets**.
- (7) In assessing costs and benefits under subclause (1), **Transpower** must consider any reasonably expected operating conditions, forecasts in the **system security forecast**, likely fuel costs, and any other reasonable assumptions.
- (8) The estimate of **expected unserved energy** in MWh multiplied by the value per MWh of that **expected unserved energy** under subclause (1) must be based on—
- (a) the estimated amount and value of the **expected unserved energy** as agreed between **Transpower** and each affected **designated transmission customer**; or
 - (b) if **Transpower** and a **designated transmission customer** cannot agree on the amount and value of the **expected unserved energy** under paragraph (a), the **value of expected unserved energy** in clause 4 of Schedule 12.2 and **Transpower's** estimate of the **expected unserved energy** in respect of each affected **designated transmission customer** and end use customer.

Compare: Electricity Governance Rules 2003 rule 5.9 section II part F

Clause 12.43: substituted, on 16 December 2013, by clause 5 of the Electricity Industry Participation (Urgent Temporary Grid Reconfiguration) Code Amendment 2013.

Clause 12.43(8)(b): amended, on 1 February 2016, by clause 49 of the Electricity Industry Participation Code Amendment (Code Review Programme) 2015.

Clause 12.43(8)(b): amended, on 1 November 2018, by clause 77 of the Electricity Industry Participation Code Amendment (Code Review Programme) 2018.

12.44 Request to the Commerce Commission to request an investment proposal be submitted

- (1) **Transpower** may request in writing that the Commerce Commission request that **Transpower** submit an investment proposal to the Commerce Commission—
 - (a) for the purposes of clause 12.40(3); or
 - (b) if permitted by a **transmission agreement**.
- (2) Unless requested to do so by the Commerce Commission, **Transpower** must not submit an investment proposal to the Commerce Commission for approval in respect of an investment that has been proposed by **Transpower** in accordance with a **transmission agreement** or clause 12.40(3).

Compare: Electricity Governance Rules 2003 rules 5.10 section II, and 12.2.2 section III part F

Resolutions of disputes

12.45 Certain disputes relating to transmission agreements may be referred to Rulings Panel

If a dispute between **Transpower** and a **designated transmission customer** concerning—

- (a) the customer specific terms of a **transmission agreement** being negotiated between those parties; or
- (b) a requested variation of any of the terms of a **default transmission agreement** (other than a variation under clause 12.12) that applies between **Transpower** and the **designated transmission customer** in accordance with clauses 12.10 to 12.13 (including a requested variation from the services described in the **default transmission agreement**); or
- (c) the schedules proposed by **Transpower** under clauses 12.10(2)(b)(v) to (viii), or as amended by **Transpower** under clause 12.10(2)(c) or
- (d) any revision to Schedule 4 or Schedule 5 of a **default transmission agreement** proposed by **Transpower** under clause 12.12; or
- (e) the schedules proposed or amended by **Transpower** under clause 12.13 on the expiry or termination of a **transmission agreement**—

is not resolved within a reasonable time, either party may refer the matter to the **Rulings Panel** for determination.

Compare: Electricity Governance Rules 2003 rule 6.1 section II part F

Clause 12.45(b), (c), and (d): amended, on 1 October 2023, by clause 30(1) of the Electricity Industry Participation Code Amendment (Default Transmission Agreement) 2023.

Clause 12.45(c): amended, on 1 October 2023, by clause 30(2) of the Electricity Industry Participation Code Amendment (Default Transmission Agreement) 2023.

Clause 12.45(e): amended, on 1 October 2023, by clause 30(3) of the Electricity Industry Participation Code Amendment (Default Transmission Agreement) 2023.

12.46 Rulings Panel has discretion to determine dispute

- (1) The **Rulings Panel** may, in its discretion, decide whether or not to undertake the determination of a dispute under clause 12.45(a) or (b).
- (2) If the **Rulings Panel** decides not to undertake the determination of the dispute, the

Rulings Panel must inform **Transpower** or the **designated transmission customer**—

- (a) that the **Rulings Panel** intends to do no more in relation to the matter; and
- (b) of the reasons for that intention.

Compare: Electricity Governance Rules 2003 rule 6.2 section II part F

12.47 Determinations by Rulings Panel

- (1) In determining a dispute under this clause, the **Rulings Panel** must take into account—
 - (a) the principles for the **default transmission agreement template** in clause 12.30; and
 - (b) the desirability of consistent treatment of **designated transmission customers** except if special circumstances justify a departure; and
 - (c) the potential impact of a decision on the contents of other **transmission agreements** or existing agreements as described in clauses 12.49 and 12.50.
- (2) The **Rulings Panel** must not determine disputes relating to the interpretation or enforcement of a **transmission agreement**.
- (3) The **Rulings Panel** must give notice to the parties of its determination, as soon as reasonably practicable.

Compare: Electricity Governance Rules 2003 rules 6.3 and 6.4 section II part F

Clause 12.47(1)(c): amended, on 16 December 2013, by clause 6 of the Electricity Industry Participation (Revocation of Part 16) Code Amendment 2013.

Clause 12.47(1)(a): amended, on 1 October 2023, by clause 31(1) of the Electricity Industry Participation Code Amendment (Default Transmission Agreement) 2023.

Clause 12.47(2): amended, on 1 October 2023, by clause 31(2) of the Electricity Industry Participation Code Amendment (Default Transmission Agreement) 2023.

12.48 Status of default transmission agreement while Rulings Panel determining dispute

Nothing in clauses 12.45 to 12.47 overrides the application of a **default transmission agreement** pending a determination of the **Rulings Panel**.

Compare: Electricity Governance Rules 2003 rule 6.5 section II part F

Clause 12.48: amended, on 1 October 2023, by clause 32 of the Electricity Industry Participation Code Amendment (Default Transmission Agreement) 2023.

Existing agreements not affected

12.49 Existing agreements

- (1) Except as provided for by clauses 12.50B and 12.95, this Part does not apply to or affect the rights, powers or obligations of a **participant** or **Transpower** under a written agreement entered into between that **participant** and **Transpower** for connection to and/or use of the **grid** that is—
 - (a) entered into before 29 October 2003; or
 - (b) based on **Transpower's** standard connection contract and entered into before 28 June 2007.
- (2) The exceptions from this Part in subclause (1) do not apply to a right, power or obligation of a **participant** that arises because of the variation of an agreement described in subclause (1).
- (3) To avoid doubt, the posted terms and conditions of **Transpower** do not constitute a written agreement.

Compare: Electricity Governance Rules 2003 rule 8.1 section II part F

Clause 12.49(1): amended, on 23 February 2015, by clause 75 of the Electricity Industry Participation Code Amendment (Distributed Generation) 2014.

Clause 12.49(1): amended, on 5 October 2017, by clause 299 of the Electricity Industry Participation Code Amendment (Code Review Programme) 2017.

Clause 12.49(1): amended, on 1 October 2023, by clause 33(1) of the Electricity Industry Participation Code Amendment (Default Transmission Agreement) 2023.

Clause 12.49(2): amended, on 1 October 2023, by clause 33(2) of the Electricity Industry Participation Code Amendment (Default Transmission Agreement) 2023.

12.50 Copies of other agreements to be provided to Authority

If requested to do so by the **Authority**, **Transpower** or a **participant** must provide a copy of any written agreement for connection to and/or use of the grid that **Transpower** or the **participant** is a party to and that was entered into before 28 June 2007, including any amendments.

Compare: Electricity Governance Rules 2003 rule 8.2 section II part F

Clause 12.50(1): amended, on 23 February 2015, by clause 75 of the Electricity Industry Participation Code Amendment (Distributed Generation) 2014.

Clause 12.50(1): amended, on 5 October 2017, by clause 300 of the Electricity Industry Participation Code Amendment (Code Review Programme) 2017.

Clause 12.50: amended, on 1 October 2023, by clause 34 of the Electricity Industry Participation Code Amendment (Default Transmission Agreement) 2023.

12.50A Amending default transmission agreement template

- (1) An amendment of the **default transmission agreement template** must have regard to the purpose, principles, and content of the **default transmission agreement template** in clause 12.29 to 12.31.
- (2) An amendment of the **Connection Code** must be carried out in accordance with clause 12.18.
- (3) For the purpose of this clause and clause 12.50B an amendment of the **default transmission agreement template** includes a replacement of the agreement.

Clause 12.50A: inserted, on 1 October 2023, by clause 35 of the Electricity Industry Participation Code Amendment (Default Transmission Agreement) 2023.

12.50B Effect of amendment of default transmission agreement template on existing agreements

- (1) This clause applies when the **Authority** amends the **default transmission agreement template**.
- (2) Subject to subclause (3), all **transmission agreements** and agreements referred to in clause 12.49(1) are deemed to be amended to the extent necessary to make them consistent with an amendment to the **default transmission agreement template**, from the date of the amendment.
- (3) Subclause (2) applies except where an amendment to the **default transmission agreement template** provides otherwise.

Clause 12.50B: inserted, on 1 October 2023, by clause 35 of the Electricity Industry Participation Code Amendment (Default Transmission Agreement) 2023.

12.50C Effect of first default transmission agreement template

Despite anything else in this Code, agreements referred to in clause 12.49(1) are deemed to be amended in respect of the first **default transmission agreement template** inserted into this Code, only to the extent necessary to make them consistent with Part D of that template.

Clause 12.50C: inserted, on 1 October 2023, by clause 35 of the Electricity Industry Participation Code Amendment (Default Transmission Agreement) 2023

12.51 Application to Rio Tinto agreements *[Revoked]*

Compare: Electricity Governance Rules 2003 rule 8.3 section II part F

Clause 12.51: revoked, on 16 December 2013, by clause 7 of the Electricity Industry Participation (Revocation of Part 16) Code Amendment 2013.

Subpart 3— Grid reliability and industry information

12.52 Contents of this subpart

This subpart relates to—

- (a) **grid reliability standards**; and
- (b) **investment contracts**; and
- (c) *[Revoked]*
- (d) grid reliability reporting.

Compare: Electricity Governance Rules 2003 rule 1 section III part F

Clause 12.52(c): revoked, on 1 February 2016, by clause 50 of the Electricity Industry Participation Code Amendment (Code Review Programme) 2015.

12.53 Purpose of the reliability and industry information clauses

The purposes of this subpart are to—

- (a) facilitate **Transpower's** ability to develop and implement long term plans (including timely securing of land access and resource consents) for investment in the **grid**; and
- (b) assist **participants** to identify and evaluate investments in **transmission alternatives**; and
- (c) facilitate efficient investment in generation; and
- (d) facilitate any processes pursuant to Part 4 of the Commerce Act 1986.

Compare: Electricity Governance Rules 2003 rule 2 section III part F

12.54 Obligations to provide information

- (1) Each **participant** must provide information reasonably required by the **Authority** for the purposes of this subpart and respond to requests from the **Authority** under this subpart promptly and accurately.
- (2) Each **participant** must use reasonable endeavours to provide accurate information.
- (3) The **Authority** is not liable for the accuracy of information provided by a **participant**.
- (4) Subject to the Official Information Act 1982, the **Authority** may at its discretion, or on the application of an affected party, withhold **publication** of confidential aspects of the information provided by a **participant** to the **Authority** if the **Authority** reasonably considers that there is good reason for withholding it.

Compare: Electricity Governance Rules 2003 rule 3 section III part F

Grid reliability standards

12.55 Authority determines grid reliability standards

- (1) The **Authority** must determine the most appropriate **grid reliability standards**.

- (2) The **Authority** must consider and determine **grid reliability standards**, having regard to the purposes set out in clause 12.56 and the principles set out in clause 12.57.
- (3) The **grid reliability standards** that apply at the commencement of this Code are the **grid reliability standards** in Schedule 12.2.

Compare: Electricity Governance Rules 2003 rule 4.1 section III part F

12.56 Purpose of grid reliability standards

The purpose of the **grid reliability standards** is to provide a basis for **Transpower** and other parties to appraise opportunities for transmission investments and **transmission alternatives**.

Compare: Electricity Governance Rules 2003 rule 4.2 section III part F

12.57 Principles of grid reliability standards

The **grid reliability standards** should—

- (a) take into account that transmission investments are long-lived assets and require a long-term planning perspective; and
- (b) reflect the public interest in reasonable stability in planning, having regard to the long term nature of investment in transmission assets; and
- (c) be consistent with **good electricity industry practice**; and
- (d) provide flexibility to allow the form of the standards to evolve over time, reflecting any changes in **good electricity industry practice**.

Compare: Electricity Governance Rules 2003 rule 4.3 section III part F

12.58 Content of grid reliability standards

- (1) The **grid reliability standards** must contain 1 or more standards for reliability of the **grid**, which may include without limitation a primary reliability standard and other reliability standards.
- (2) The reliability standards set out in the **grid reliability standards** may differ to reflect differing circumstances in different regions supplied by the **grid**.
- (3) The **grid reliability standards** may include 1 or more standards for reliability of the **core grid**.
- (4) The **grid reliability standards** may contain supporting information, such as information summarising economic assessments balancing different levels of reliability and the expected value of energy at risk.

Compare: Electricity Governance Rules 2003 rule 4.4 section III part F

Review of grid reliability standards

12.59 Interested parties may request review of grid reliability standards

- (1) 1 or more interested parties may request a review by the **Authority** of the **grid reliability standards**. The request must be in the form of a written submission to the **Authority** describing—
 - (a) the nature of the interest of each party seeking the review; and
 - (b) how the review might enable the **grid reliability standards** to better reflect the purpose and principles set out in clauses 12.56 and 12.57

- (2) In addition to receiving written submissions, the **Authority** may elect to hear 1 or more oral submissions.
- (3) The **Authority** must either undertake a review of the **grid reliability standards**, or decline to review the **grid reliability standards** and **publish** reasons for declining.

Compare: Electricity Governance Rules 2003 rule 5.1 section III part F

12.60 Authority review of grid reliability standards

The **Authority** may initiate a review of the **grid reliability standards** for any reason consistent with the main objective of the **Authority** in section 15 of the **Act** and the purpose and principles set out in clauses 12.56 and 12.57.

Compare: Electricity Governance Rules 2003 rule 5.2 section III part F

Clause 12.60: amended, on 1 March 2024, by clause 57 of the Electricity Industry Participation Code Amendment (Code Review Programme) 2024

12.61 Authority must publish draft grid reliability standards

- (1) This clause applies if the **Authority** undertakes a review of the **grid reliability standards** under clauses 12.59 or 12.60.
- (2) The **Authority** must **publish** draft **grid reliability standards**.
- (3) At the time the **Authority** publishes the draft **grid reliability standards** the **Authority** must **publish** the date by which submissions on the draft **grid reliability standards** are to be received by the **Authority**. The date must be no earlier than 15 **business days** from the date of **publication** of the draft **grid reliability standards**.
- (4) Each submission on the draft **grid reliability standards** must be made in writing to the **Authority** and be received on or before the **submission expiry date**. In addition to receiving written submissions, the **Authority** may elect to hear 1 or more oral submissions.

Compare: Electricity Governance Rules 2003 rules 4.5 and 4.6 section III part F

Clause 12.61(3): amended, on 5 October 2017, by clause 301 of the Electricity Industry Participation Code Amendment (Code Review Programme) 2017.

12.62 Decision on grid reliability standards

Within 20 **business days** of the **submission expiry date** (or such longer period as the **Authority** may allow), the **Authority** must complete its consideration of all submissions it receives on the draft **grid reliability standards** and consider whether to include the **grid reliability standards** as a schedule to this Part, in accordance with the **Act**.

Compare: Electricity Governance Rules 2003 rule 4.7 section III part F

Core grid determination

12.63 Authority determines core grid determination

- (1) The **Authority** must determine the most appropriate **core grid determination**.
- (2) The **core grid** specified in the **core grid determination** must include—
 - (a) at a minimum, those **assets** that comprise the main elements of the **grid**; and
 - (b) at most, all **assets** that form part of the **grid** and operate at nominal voltages of 66kV and above.
- (3) In determining the most appropriate **core grid determination**, and in a subsequent

review of the **core grid determination**, the **Authority** must have regard to—

- (a) the purposes set out in clause 12.64; and
 - (b) the principles set out in clause 12.57 for the **grid reliability standards**; and
 - (c) the objectives set out in clause 12.65.
- (4) In determining the most appropriate **core grid determination**, the **Authority** may engage **Transpower** or any other person to assist in the preparation of all or part of the **core grid determination**.
- (5) The **core grid determination** that applies at the commencement of this Code is the **core grid determination** in Schedule 12.3.

Compare: Electricity Governance Rules 2003 rule 5A.1 section III part F

12.64 Purpose of core grid determination

The purpose of the **core grid determination** is to provide a basis for—

- (a) the **Authority** to determine the **grid reliability standards**; and
- (b) **Transpower** and other parties to appraise opportunities for transmission investment and **transmission alternatives**.

Compare: Electricity Governance Rules 2003 rule 5A.2 section III part F

12.65 Objectives of core grid determination

The **Authority** must have regard to the following objectives in determining, and in any subsequent review of, the **core grid determination**:

- (a) avoiding the failure or removal from service of any **asset** forming part of the **core grid**, if the failure or removal from service of that **asset** may result in cascade failure;
- (b) providing flexibility to allow the **core grid** to evolve over time, reflecting any changes in the **grid**;
- (c) reflecting the public interest in reasonable stability in planning for transmission.

Compare: Electricity Governance Rules 2003 rule 5A.3 section III part F

Review of core grid determination

12.66 Interested parties may request review of core grid determination

- (1) 1 or more interested parties may request a review by the **Authority** of the **core grid determination**. The request must be in the form of a written submission to the **Authority** describing—
- (a) the nature of the interest of each party seeking the review; and
 - (b) how the review might enable the **core grid determination** to better reflect the purpose and objectives set out in clauses 12.64 and 12.65 respectively.
- (2) In addition to receiving written submissions, the **Authority** may elect to hear 1 or more oral submissions.
- (3) The **Authority** must either undertake a review of the **core grid determination**, or decline to review the **core grid determination** and **publish** reasons for declining.

Compare: Electricity Governance Rules 2003 rule 5B.1 section III part F

12.67 Authority review of grid determination

The **Authority** may initiate a review of the **core grid determination** for any reason consistent with the main objective of the **Authority** in section 15 of the **Act** and the purpose and objectives set out in clauses 12.64 and 12.65 respectively.

Compare: Electricity Governance Rules 2003 rule 5B.2 section III part F

Clause 12.67: amended, on 1 March 2024, by clause 58 of the Electricity Industry Participation Code Amendment (Code Review Programme) 2024.

12.68 Authority must publish draft core grid determination

- (1) This clause applies if the **Authority** undertakes a review of the **core grid determination** in accordance with clauses 12.66 or 12.67.
- (2) The **Authority** must **publish** a draft **core grid determination**.
- (3) When the **Authority publishes** the draft **core grid determination** the **Authority** must **publish** the date by which submissions on the draft **core grid determination** are to be received by the **Authority**. The date must be no earlier than 15 **business days** from the date of publication of the draft **core grid determination**.
- (4) Each submission on the draft **core grid determination** must be made in writing to the **Authority** and be received on or before the **submission expiry date**. In addition to receiving written submissions, the **Authority** may elect to hear 1 or more oral submissions.

Compare: Electricity Governance Rules 2003 rules 5A.4 and 5A.5 section III part F

Clause 12.68(3): amended, on 5 October 2017, by clause 302 of the Electricity Industry Participation Code Amendment (Code Review Programme) 2017.

12.69 Decision on core grid determination

Within 20 **business days** of the **submission expiry date** (or such longer period as the **Authority** may allow), the **Authority** must complete its consideration of all submissions it receives on the draft **core grid determination** and consider whether to include the **core grid determination** in a schedule to this Part.

Compare: Electricity Governance Rules 2003 rule 5A.6 section III part F

Investment contracts

12.70 Purpose

Clause 12.71 provides for **investment contracts** to be agreed between **designated transmission customers** and **Transpower**, and establishes a process to manage any potential implications for **grid reliability standards**.

Compare: Electricity Governance Rules 2003 rule 8.1 section III part F

12.71 Investment contracts

Transpower may enter into an **investment contract** with implications for **grid reliability standards** only if—

- (a) the **investment contract** is consistent with the **grid reliability standards** or the proposed investment has been approved by the **Authority** under clause 12.36(2), and clause 12.36(2) will apply as if the **investment contract** was a **transmission**

agreement; and

(b) **Transpower** advises the **Authority** of the proposed **investment contract**.

Compare: Electricity Governance Rules 2003 rule 8.2 section III part F

Clause 12.71(b): amended, on 1 November 2018, by clause 78 of the Electricity Industry Participation Code Amendment (Code Review Programme) 2018.

Centralised data set [Revoked]

Cross Heading: revoked, on 1 February 2016, by clause 51(1) of the Electricity Industry Participation Code Amendment (Code Review Programme) 2015.

12.72 Authority to establish and maintain centralised data set [Revoked]

Compare: Electricity Governance Rules 2003 rule 11.1 section III part F

Clause 12.72: revoked, on 1 February 2016, by clause 51(2) of the Electricity Industry Participation Code Amendment (Code Review Programme) 2015.

12.73 Purpose of centralised data set [Revoked]

Compare: Electricity Governance Rules 2003 rule 11.2 section III part F

Clause 12.73: revoked, on 1 February 2016, by clause 51(2) of the Electricity Industry Participation Code Amendment (Code Review Programme) 2015.

12.74 Contents of centralised data set [Revoked]

Compare: Electricity Governance Rules 2003 rule 11.3 section III part F

Clause 12.74: revoked, on 1 February 2016, by clause 51(2) of the Electricity Industry Participation Code Amendment (Code Review Programme) 2015.

12.75 Public access to centralised data set [Revoked]

Compare: Electricity Governance Rules 2003 rule 11.4 section III part F

Clause 12.75: revoked, on 1 February 2016, by clause 51(2) of the Electricity Industry Participation Code Amendment (Code Review Programme) 2015.

Grid reliability reporting

12.76 Transpower to publish grid reliability report

- (1) **Transpower** must **publish** a **grid reliability report** setting out—
 - (a) a forecast of **demand** at each **grid exit point** over the next 10 years; and
 - (b) a forecast of **supply** at each **grid injection point** over the next 10 years; and
 - (c) whether the power system is reasonably expected to meet the **N-1 criterion**, including in particular whether the power system would be in a **secure state** at each **grid exit point**, at all times over the next 10 years; and
 - (d) proposals for addressing any matters identified in accordance with paragraph (c).
- (2) **Transpower** must **publish** a **grid reliability report** no later than 2 years after the date on which it **published** the previous **grid reliability report**, or such other date as determined by the **Authority** (having consulted with **Transpower**).
- (3) If there is a material change in the forecast **demand** at a **grid exit point** or in the forecast **supply** at a **grid injection point** in the period to which the most recent **grid reliability report** relates, **Transpower** must **publish** a revised **grid reliability report** as soon as reasonably practicable after the material change.

Compare: Electricity Governance Rules 2003 rule 12A section III part F

Clause 12.76(2): amended, on 21 September 2012, by clause 17 of the Electricity Industry Participation (Minor Amendments) Code Amendment 2012.

Clause 12.76(1): amended, on 5 October 2017, by clause 303 of the Electricity Industry Participation Code Amendment (Code Review Programme) 2017.

Subpart 4—Transmission pricing methodology

12.77 Recovery of investment costs by Transpower

The costs incurred by **Transpower** (irrespective of when they are incurred) in relation to an **approved investment** are recoverable by **Transpower** from **designated transmission customers** on the basis of **the transmission pricing methodology** and must be paid by **designated transmission customers** accordingly.

Compare: Electricity Governance Rules 2003 rule 17.1 section III part F

12.78 Purpose for establishing transmission pricing methodology

The purpose of the **transmission pricing methodology** is to ensure that, subject to Part 4 of the Commerce Act 1986, the full economic costs of **Transpower's** services are allocated in accordance with the **Authority's** main objective in section 15 of the **Act**.

Compare: Electricity Governance Rules 2003 rule 1 section IV part F

Clause 12.78: amended, on 1 June 2011, by clause 4 of the Electricity Industry Participation (Transmission Pricing) Code Amendment 2011.

Clause 12.78: amended, on 1 March 2024, by clause 59 of the Electricity Industry Participation Code Amendment (Code Review Programme) 2024.

12.79 Main statutory objective

Transpower, in developing the **transmission pricing methodology**, and the **Authority**, in approving the **transmission pricing methodology**, must assess the **transmission pricing methodology** against the **Authority's** main objective in section 15 of the **Act**.

Compare: Electricity Governance Rules 2003 rule 2 section IV part F

Clause 12.79: substituted, on 1 June 2011, by clause 5 of the Electricity Industry Participation (Transmission Pricing) Code Amendment 2011.

Clause 12.79: Heading: amended, on 1 March 2024, by clause 60(1) of the Electricity Industry Participation Code Amendment (Code Review Programme) 2024.

Clause 12.79: amended, on 1 March 2024, by clause 60(2) of the Electricity Industry Participation Code Amendment (Code Review Programme) 2024.

12.80 Application and interpretation of pricing principles *[Revoked]*

Compare: Electricity Governance Rules 2003 rule 3 section IV part F

Clause 12.80: revoked, on 1 June 2011, by clause 6 of the Electricity Industry Participation (Transmission Pricing) Code Amendment 2011.

12.81 Authority must prepare an issues paper

- (1) The **Authority** must prepare an issues paper on—
 - (a) the process for development and approval of the **transmission pricing methodology**; and
 - (b) the guidelines to be followed by **Transpower** in preparing a methodology for allocating **Transpower's** revenues to **designated transmission customers**.
- (2) The process and guidelines must be developed in accordance with the **Authority's** main objective in section 15 of the **Act**.

Compare: Electricity Governance Rules 2003 rule 4 section IV part F

Clause 12.81: substituted, on 1 June 2011, by clause 7 of the Electricity Industry Participation (Transmission Pricing) Code Amendment 2011.

Clause 12.81(2): amended, on 1 March 2024, by clause 61 of the Electricity Industry Participation Code Amendment (Code Review Programme) 2024.

12.82 Authority must consult on issues paper

- (1) When the **Authority publishes** the issues paper, the **Authority** must **publish** of the date by which submissions are to be received by the **Authority**. The date must be no earlier than 15 **business days** from the date of **publication** of the issues paper.
- (2) Each submission on the issues paper must be made in writing to the **Authority** and received on or before the **submission expiry date**. In addition to receiving written submissions, the **Authority** may elect to hear one or more oral submissions.
- (3) Within 20 **business days** of the **submission expiry date** (or such longer period as the **Authority** may allow), the **Authority** must complete its consideration of all submissions it receives on the issues paper.

Compare: Electricity Governance Rules 2003 rule 5 section IV part F

Clause 12.82(1): amended, on 5 October 2017, by clause 304 of the Electricity Industry Participation Code Amendment (Code Review Programme) 2017.

12.83 Authority must publish process and guidelines for development of transmission pricing methodology

After consideration of submissions in clause 12.82(3), the **Authority** must, as soon as reasonably practicable, **publish**—

- (a) the process for the development of the **transmission pricing methodology**; and
- (b) any guidelines that **Transpower** must follow in developing the **transmission pricing methodology**.

Compare: Electricity Governance Rules 2003 rule 6 section IV part F

Clause 12.83: heading amended, on 1 June 2011, by clause 8(1) of the Electricity Industry Participation (Transmission Pricing) Code Amendment 2011.

Clause 12.83(b): amended, on 1 June 2011, by clause 8(2) of the Electricity Industry Participation (Transmission Pricing) Code Amendment 2011.

Development of transmission pricing methodology by Transpower

12.84 Transmission pricing methodology

The **transmission pricing methodology** that applies at the commencement of this Code is the **transmission pricing methodology** in Schedule 12.4.

Clause 12.83(b): amended, on 1 June 2011, by clause 8(2) of the Electricity Industry Participation (Transmission Pricing) Code Amendment 2011.

Clause 12.84 heading: amended, on 20 December 2021, by clause 49 of the Electricity Industry Participation Code Amendment (Code Review Programme) 2019.

Review of an approved transmission pricing methodology

Heading: amended, on 1 June 2011, by clause 9 of the Electricity Industry Participation (Transmission Pricing) Code Amendment 2011.

12.85 Review by Transpower

At any time, **Transpower** may submit to the **Authority** a proposed variation of its **transmission pricing methodology**, provided that the submission is made at least 12 months after the last **Authority** approval of the **transmission pricing methodology**.

Compare: Electricity Governance Rules 2003 rule 11.1 section IV part F

12.86 Review by Authority

The **Authority** may review an approved **transmission pricing methodology** if it considers that there has been a material change in circumstances.

Compare: Electricity Governance Rules 2003 rule 11.2 section IV part F

Clause 12.86 heading: amended, on 20 December 2021, by clause 50 of the Electricity Industry Participation Code Amendment (Code Review Programme) 2019.

12.87 Process for review

A review of the **transmission pricing methodology** must take into account the requirements of clauses 12.79 and 12.89(1). The **Authority** must follow the processes outlined in clauses 12.91 to 12.94 when reviewing a **transmission pricing methodology**.

Compare: Electricity Governance Rules 2003 rule 11.3 section IV part F

12.88 Transpower to submit methodology

- (1) **Transpower** must submit a proposed **transmission pricing methodology** to the **Authority** within 90 days (or such longer period as the **Authority** may allow) of receipt of a written request from the **Authority**.
- (2) The **Authority** may, after **publishing** the process described in clause 12.83(a) and the guidelines described in clause 12.83(b), issue such a request.

Compare: Electricity Governance Rules 2003 rule 7.1 section IV part F

12.89 Form of proposed transmission pricing methodology

- (1) **Transpower** must develop its proposed **transmission pricing methodology** consistent with—
 - (a) any determination made under Part 4 of the Commerce Act 1986; and
 - (b) the **Authority's** main objective in section 15 of the **Act**; and
 - (c) any guidelines **published** under clause 12.83(b).
- (2) **Transpower's** proposed **transmission pricing methodology** must include indicative prices to allow the **Authority** and interested parties to understand the impact of the methodology on **designated transmission customers**.

Compare: Electricity Governance Rules 2003 rule 7.2 section IV part F

Clause 12.89 (1)(b): substituted, on 1 June 2011, by clause 10 of the Electricity Industry Participation (Transmission Pricing) Code Amendment 2011.

Clause 12.89(1)(b): amended, on 1 March 2024, by clause 62 of the Electricity Industry Participation Code Amendment (Code Review Programme) 2024..

12.90 Authority may decline to consider proposed transmission pricing methodology

- (1) The **Authority** may decline to consider the proposed **Transpower transmission pricing methodology** if, in the **Authority's** view, **Transpower** has not provided sufficient information for the **Authority** to make an informed assessment of the matters referred to in clauses 12.91 to 12.94.
- (2) If the **Authority** so declines, the **Authority** must advise **Transpower** of the extra information required, and **Transpower** must provide a revised **transmission pricing methodology** by a date specified by the **Authority**.

Compare: Electricity Governance Rules 2003 rule 7.3 section IV part F

Process for determination of transmission pricing methodology

12.91 Authority may approve proposed transmission pricing methodology or refer back to Transpower

- (1) After consideration of **Transpower's** proposed **transmission pricing methodology**, the **Authority** may either—
 - (a) approve the proposed **transmission pricing methodology** having regard to the requirements of clause 12.89(1); or
 - (b) refer the proposed **transmission pricing methodology** back to **Transpower** if in the **Authority's** view the proposed **transmission pricing methodology** does not adequately conform to the requirements of clause 12.89(1) and **Transpower** will have 20 **business days** to consider the **Authority's** concerns and to resubmit its proposed **transmission pricing methodology** for consideration by the **Authority**.
- (2) If the **Authority** considers that the **transmission pricing methodology** resubmitted by **Transpower** under subclause (1)(b) does not conform to the requirements of clause 12.89(1), the **Authority** may make any amendments it considers necessary to ensure that the proposed **transmission pricing methodology** adequately conforms to the requirements of clause 12.89(1).

Compare: Electricity Governance Rules 2003 rule 8.1 section IV part F

12.92 Authority must publish proposed transmission pricing methodology

- (1) The **Authority** must **publish** the proposed **transmission pricing methodology** as soon as practicable.
- (2) At the time the **Authority publishes** the proposed **transmission pricing methodology** the **Authority** must **publish** the date by which submissions are to be received by the **Authority**. The date must be no earlier than 15 **business days** from the date of **publication** of the proposed **transmission pricing methodology**.
- (3) Each submission on the proposed **transmission pricing methodology** must be made in writing to the **Authority** and received on or before the **submission expiry date**. In addition to receiving written submissions, the **Authority** may elect to hear 1 or more oral submissions.

Compare: Electricity Governance Rules 2003 rules 8.2 and 8.3 section IV part F

Clause 12.92(2): amended, on 5 October 2017, by clause 305 of the Electricity Industry Participation Code Amendment (Code Review Programme) 2017.

12.93 Decision on transmission pricing methodology

Within 40 **business days** of the **submission expiry date** (or such longer period as the **Authority** may allow), the **Authority** must complete its consideration of all submissions it receives on a proposed **transmission pricing methodology** and consider whether to include the **transmission pricing methodology** in a schedule to this Part and, if so, the date that the **transmission pricing methodology** will take effect.

Compare: Electricity Governance Rules 2003 rule 8.4 section IV part F

12.94 Authority to determine commencement date

In determining a date on which the **transmission pricing methodology** must take

effect, the **Authority** must consult with **Transpower**.

Compare: Electricity Governance Rules 2003 rule 8.5 section IV part F

Amending the transmission pricing methodology

Cross Heading: inserted, on 25 July 2022, by clause 4 of the Electricity Industry Participation Code Amendment (Transmission Pricing Methodology Related Amendments) 2022.

12.94A Amending the transmission pricing methodology

Despite anything else in this Code, the **Authority** may amend the **transmission pricing methodology** under section 38 of the **Act** if—

- (a) the **Authority** is satisfied on reasonable grounds regarding any of the matters in section 39(3)(a), (b) or (c) of the **Act** (in which case sections 39(1)(b) and (c) of the **Act** will not apply to the amendment); or
- (b) section 40 of the **Act** applies (in which case section 39(1) of the **Act** will not apply to the amendment).

Clause 12.94A: inserted, on 25 July 2022, by clause 4 of the Electricity Industry Participation Code Amendment (Transmission Pricing Methodology Related Amendments) 2022.

Application of approved transmission pricing methodology

12.95 Charges to comply with transmission pricing methodology

Transpower must charge for those transmission services affected only in accordance with the **transmission pricing methodology**.

Compare: Electricity Governance Rules 2003 rule 9.1 section IV part F

Clause 12.95(1): amended, on 16 December 2013, by clause 8(1) of the Electricity Industry Participation (Revocation of Part 16) Code Amendment 2013.

Clause 12.95(2): revoked, on 16 December 2013, by clause 8(2) of the Electricity Industry Participation (Revocation of Part 16) Code Amendment 2013.

Clause 12.95: replaced, on 1 April 2023, by clause 5 of the Electricity Industry Participation Code Amendment (Transmission Pricing Methodology Related Amendments) (No 2) 2022.

12.96 Development of transmission prices

After approval of the **transmission pricing methodology**, **Transpower** must—

- (a) develop and **publish** transmission prices consistent with the **transmission pricing methodology** based on its total revenue requirement for connection to or use of the **grid**; and
- (b) demonstrate to the **Authority** that the prices are consistent with the **transmission pricing methodology**.

Compare: Electricity Governance Rules 2003 rule 9.2 section IV part F

Clause 12.96(a): amended, on 23 February 2015, by clause 75 of the Electricity Industry Participation Code Amendment (Distributed Generation) 2014.

Clause 12.96(a): amended, on 5 October 2017, by clause 306 of the Electricity Industry Participation Code Amendment (Code Review Programme) 2017.

Audit of transmission prices

12.97 Audit of transmission prices

- (1) The **Authority** may appoint an **auditor** to confirm whether **Transpower's** transmission prices have been calculated in accordance with the **transmission pricing methodology**.
- (2) **Transpower** must ensure that the **auditor's** report includes the **auditor's** view on

whether the application of the **transmission pricing methodology** by **Transpower** contains errors or inconsistencies that may have a material impact on the prices of any individual **designated transmission customers**, or **designated transmission customers** in general.

- (3) **Transpower** must provide the **auditor** with all relevant information required by the **auditor** to complete its review.

Compare: Electricity Governance Rules 2003 rule 9.3 section IV part F
Clause 12.97(2): amended, on 1 February 2016, by clause 52 of the Electricity Industry Participation Code Amendment (Code Review Programme) 2015.

12.98 Transpower may respond to auditor's report

Transpower must ensure that the **auditor's** report includes any comments that **Transpower** provided to the **auditor** within 15 **business days** of **Transpower** receiving a draft of the report.

Compare: Electricity Governance Rules 2003 rule 9.4 section IV part F
Clause 12.98: substituted, on 1 February 2016, by clause 53 of the Electricity Industry Participation Code Amendment (Code Review Programme) 2015.

12.99 Final auditor report to the Authority

- (1) **Transpower** must ensure that, within 10 **business days** after the **auditor** receives **Transpower's** response under clause 12.98, the **auditor** provides a report to the **Authority** certifying that either—

- (a) **Transpower** had applied correctly the approved **transmission pricing methodology**; or
(b) material errors remained in **Transpower's** application of the **transmission pricing methodology**.

- (2) Within 5 **business days** of receiving the report, the **Authority** must **publish** the **auditor's** report.

Compare: Electricity Governance Rules 2003 rules 9.5 and 9.6 section IV part F
Clause 12.99(1): amended, on 1 February 2016, by clause 54 of the Electricity Industry Participation Code Amendment (Code Review Programme) 2015.

12.100 Transpower to redetermine transmission prices

If the **auditor** concludes that there are material errors in **Transpower's** application of the **transmission pricing methodology**, **Transpower** must recalculate and **publish** revised transmission prices to correct identified errors.

Compare: Electricity Governance Rules 2003 rule 9.7 section IV part F

12.101 Auditor's costs

Transpower must meet the actual and reasonable expenses of the **auditor**.

Compare: Electricity Governance Rules 2003 rule 9.8 section IV part F

12.102 Enforcement of transmission charges

- (1) The approved **transmission pricing methodology** must be incorporated in **transmission agreements** between **Transpower** and **designated transmission customers**.

- (2) The amount payable by a **designated transmission customer** under a **transmission agreement** under subclause (1)—
- (a) is recoverable in any court of competent jurisdiction as a debt due to **Transpower**; and
 - (b) may be challenged in any proceedings to recover the debt on the ground that **Transpower** has incorrectly applied the **transmission pricing methodology** in a manner that is adverse to the **designated transmission customer** but the **transmission pricing methodology** itself may not be challenged.

Compare: Electricity Governance Rules 2003 rule 10 section IV part F

Information for calculating transmission charges

Cross Heading: inserted, on 25 July 2022, by clause 5 of the Electricity Industry Participation Code Amendment (Transmission Pricing Methodology Related Amendments) 2022.

12.102A Information held by system operator may be used to calculate charges

- (1) The **system operator** may provide to **Transpower** any information the **system operator** holds that the **system operator** or **Transpower** considers **Transpower** reasonably needs to calculate charges under the **transmission pricing methodology**.
- (2) **Transpower** may use any information provided to it by the **system operator** under this clause to calculate charges under the **transmission pricing methodology**. **Transpower** must not use the information for any other purpose except—
 - (a) as provided for in this Code; or
 - (b) as required by law; or
 - (c) if the information is or becomes publicly available; or
 - (d) if the information is or has been provided to **Transpower** other than under this clause and without restriction as to **Transpower's** use of it for the other purpose; or
 - (e) otherwise as may be agreed with the **participant** or other person who is the subject of the information.

Clause 12.102A: inserted, on 25 July 2022, by clause 5 of the Electricity Industry Participation Code Amendment (Transmission Pricing Methodology Related Amendments) 2022.

12.102B Information about embedded electricity

- (1) In this clause, “AMDR”, “capacity”, “consuming plant”, “difference cap”, “embedded electricity”, and “generating plant” have the meanings given to those terms in the **transmission pricing methodology**.
- (2) This clause applies where the **Authority** or **Transpower** reasonably considers a **participant** owns generating plant with a total capacity of 10 MW or more directly or indirectly connected to the same **point of connection** in respect of which **Transpower** holds insufficient information to calculate embedded electricity under the **transmission pricing methodology**.
- (3) If subclause (2) applies, the **Authority** or **Transpower** may request that the **participant** provide the information specified in subclause (5) to **Transpower** in a format reasonably requested by the **Authority** or **Transpower**.

- (4) The **Authority** or **Transpower** (as applicable) must withdraw a request made under subclause (3) if the **participant** satisfies the **Authority** or **Transpower** (as applicable) within 10 **business days** (or such longer period as provided for by the **Authority** or **Transpower**) of the request that—
- (a) the **participant** does not own the generating plant referred to in subclause (2); or
 - (b) the generating plant does not have a total capacity of 10 **MW** or more directly or indirectly connected to the same **point of connection**; or
 - (c) the total capacity of any consuming plant supplied or potentially supplied by the generating plant, without that **electricity** first flowing through a **point of connection**, is 1 **MW** or less.
- (5) The information referred to in subclause (3) is any information about the **electricity** generated by the **participant's** generating plant referred to in subclause (2) (whether **metered** or estimated) for any **trading period** or **trading periods** specified by the **Authority** or **Transpower** from (and including) **trading period 1** on 1 July 2014 to (and including) **trading period 48** on the day immediately before the date of the request under subclause (3).
- (6) **Transpower** may use any information provided to it by a **participant** under this clause to calculate charges under the **transmission pricing methodology**. **Transpower** must not use the information for any other purpose except—
- (a) as provided for in this Code; or
 - (b) as required by law; or
 - (c) if the information is or becomes publicly available; or
 - (d) if the information is or has been provided to **Transpower** other than under this clause and without restriction as to **Transpower's** use of it for the other purpose; or
 - (e) otherwise as may be agreed with the **participant**.
- (7) Subject to subclause (9), if—
- (a) a **participant** does not provide to **Transpower** any or all of the information requested by the **Authority** or **Transpower** under subclause (5) within 20 **business days** (or such longer period as provided for by the **Authority** or **Transpower**) of the date of the request under subclause (3); or
 - (b) any or all of the information provided is not provided in the requested format or another format **Transpower** can reasonably use for calculating charges under the **transmission pricing methodology**; or
 - (c) **Transpower** reasonably considers any or all of the information provided is not sufficiently reliable for calculating charges under the **transmission pricing methodology**,
- Transpower** must use the values specified in subclause (8) to calculate charges under the **transmission pricing methodology** in place of the information that is not provided, is not in the requested format or another format **Transpower** can reasonably use, or is not sufficiently reliable.
- (8) The values referred to in subclause (7) are, for calculating the relevant

designated transmission customer's AMDR and difference cap under the **transmission pricing methodology**, a value or values of **electricity** generated by the generating plant calculated as if it were operating at its capacity.

- (9) Subclause (7) is subject to any requirement on **Transpower** in this Code to use information from a specific source to calculate charges under the **transmission pricing methodology**.

Clause 12.102B: inserted, on 25 July 2022, by clause 5 of the Electricity Industry Participation Code Amendment (Transmission Pricing Methodology Related Amendments) 2022.

Subpart 5—Financial transmission rights *[Revoked]*

Subpart 5: revoked, on 1 October 2011, by clause 6 of the Electricity Industry Participation (Financial Transmission Rights) Code Amendment 2011.

12.103 Contents of this subpart *[Revoked]*

Compare: Electricity Governance Rules 2003 rule 1 section V part F

Clause 12.103: revoked, on 1 October 2011, by clause 6 of the Electricity Industry Participation (Financial Transmission Rights) Code Amendment 2011.

12.104 Design *[Revoked]*

Compare: Electricity Governance Rules 2003 rule 2 section V part F

Clause 12.104: revoked, on 1 October 2011, by clause 6 of the Electricity Industry Participation (Financial Transmission Rights) Code Amendment 2011.

Subpart 6—Interconnection asset services

12.105 Purpose of this subpart

The purpose of this subpart is to—

- (a) create incentives on **Transpower**, through enforceable service measures, to provide **interconnection assets** at the capacity ratings required by **designated transmission customers** and other **grid** users; and
- (b) ensure that **Transpower** provides information on the capacity of **interconnection assets**, and their reliability and availability, to enable **grid** users to monitor the capacity and performance of **interconnection assets**; and
- (c) establish processes for the identification of investments in the **grid**, and alternatives to such investments, to ensure efficient decision-making on the use of and upgrades to the **grid**; and
- (d) specify the circumstances in which **Transpower** may permanently or temporarily remove **interconnection assets** from service or reconfigure the **grid**.

Compare: Electricity Governance Rules 2003 rule 1 section VI part F

Clause 12.105(d): amended, from 2 March 2012 to 3 December 2012, by clause 4 of the Electricity Industry Participation (Temporary Grid Reconfiguration) Code Amendment 2012.

Clause 12.105(d): amended, from 15 March 2013 to 15 December 2013, by clause 4 of the Electricity Industry Participation (Temporary Grid Reconfiguration) Code Amendment 2013.

Clause 12.105(d): amended, 16 December 2013, by clause 6 of the Electricity Industry Participation (Urgent Temporary Grid Reconfiguration) Code Amendment 2013.

12.106 Interconnection asset capacity and grid configuration

- (1) The interconnection asset capacity and grid configuration set out in schedule F6 of section VI of part F of the **rules** immediately before this Code came into force, continues in force and is deemed to be the interconnection asset capacity and grid

configuration that applies at the commencement of this Code.

- (2) Clause 12.110 applies to the interconnection asset capacity and grid configuration.

12.107 Transpower to identify interconnection branches, and propose service measures and levels

- (1) **Transpower** must provide the **Authority** with the information set out in subclause (4) and a diagram showing the configuration of the **grid**, other than **connection assets**.
- (2) **Transpower** must provide the information and diagram referred to in subclause (1) to the **Authority** in the form specified by the **Authority**.
- (3) The interconnection asset capacity and grid configuration referred to in subclause (1) must be provided within 3 months of the date on which the **Authority**, in accordance with subclause (2), sets the form in which the interconnection asset capacity and grid configuration must be provided.
- (4) The information required under subclause (1) is—
- (a) for each **interconnection circuit branch**, the following service measures and service levels:
- (i) the overall continuous capacity rating of the **interconnection circuit branch**, for both summer and winter periods in MVA and amperes:
 - (ii) the level of impedance of the interconnection **circuit branch** both **resistive** and **reactive** and for **assets** arranged in both **shunt** and **series** in PU, using a base of 100 MVA, provided the impedance of the **interconnection circuit branch** is equal to or more than 0.0001 PU, using 100 MVA as the base:
 - (iii) the nominal high voltage rating of each interconnection **circuit branch** in kV:
 - (iv) the high voltage range that each **interconnection circuit branch** can be operated over in kV, specified as a maximum and a minimum; and
- (b) for each **interconnection transformer branch**, the following information:
- (i) the overall 24 hour post contingency capacity rating of the **interconnection transformer branch**, for both the summer and winter period, in amperes and MVA as follows:
 - (A) for 2 Winding **interconnection transformer branches**, the overall 24 hour post contingency capacity rating:
 - (B) for 3 Winding **interconnection transformer branches**, the overall 24 hour post contingency capacity rating, at HV, MV, and LV:
 - (ii) the continuous capacity rating of the **interconnection transformer branch** in amperes and MVA as follows:
 - (A) for 2 Winding **interconnection transformer branches**, the continuous capacity rating:
 - (B) for 3 Winding **interconnection transformer branches**, the continuous capacity rating, at HV, MV, and LV:
 - (iii) the level of impedance of the **interconnection transformer branch**, both **resistive** and **reactive** and for **assets** arranged in both **shunt** and in **series** in PU, using a base of 100 MVA, as follows:
 - (A) for 2 Winding **interconnection transformer branches**, the level of

- impedance of the **interconnection transformer branch**:
- (B) for 3 Winding **interconnection transformer branches**, the level of impedance of the **interconnection transformer branch**, at HV, MV, and LV:
 - (iv) the nominal high voltage rating of the interconnection **transformer branch** in kV:
 - (v) the high voltage range that the interconnection **transformer branch** can be operated over in kV, specified as a maximum, and a minimum:
 - (vi) in respect of the tapping steps and ranges of the **interconnection transformer branch**:
 - (A) the tap voltage range in volts, specified as a maximum and a minimum:
 - (B) the **number** of tapping steps:
 - (C) the size of each tapping step as a percentage of the operational voltage range:
 - (D) whether the tapping step is on-load or off-load:
 - (E) whether on-load tapping capacity is automatic or manual;
 - (F) if on-load tapping capacity is automatic, whether it is auto-selected:
 - (G) if on-load tapping capacity is manual, the tap step it is normally set to, which for the purposes of this clause is the actual or expected position at winter peak demand; and
- (c) the transfer capacity in the North and South transfer for each **HVDC link configuration** expressed as follows:
- (i) DC sent in **MW**:
 - (ii) AC received in **MW**; and
- (d) for each **shunt asset**, the following service measures and service levels:
- (i) the overall capacity rating, in MVAR, in terms of both absorption or provision:
 - (ii) the nominal voltage rating of the **shunt asset** in kV:
 - (iii) the maximum and minimum voltage range in kV that the **shunt asset** can operate over; and
- (e) in addition to the information required under paragraph (d) in relation to **shunt assets**:
- (i) whether each **shunt asset** is dynamic or static:
 - (ii) if the **shunt asset** is dynamic, whether it is an SVC or synchronous compensator:
 - (iii) any **shunt assets** that may directly affect the capacity of the **HVDC link** as set out in paragraph (c) and the likely magnitude of such effect; and
- (f) the dates for the summer and winter periods or other such defined periods as may apply for the purposes of paragraphs (a) and (b).
- (5) The information provided under subclause (4) must,—
- (a) in the case of information provided under subclause (4)(a), (c) and (d), be consistent with the information disclosed by **Transpower** in the most recent **asset capability statement** provided by **Transpower** under clause 2(5) of **Technical**

- Code A** of Schedule 8.3; and
- (b) in the case of information provided under subclause (4)(b), be consistent with the **manufacturer's specification** for the component **assets** and the information disclosed by **Transpower** in the most recent **asset capability statement** provided under clause 2(5) of **Technical Code A** of Schedule 8.3, if this differs from the **manufacturer's specifications**;
 - (c) in the case of information provided under subclause (4)(a), be consistent with the thermal design rating of each **interconnection branch**; and
 - (d) cover every **interconnection asset**, either as part of an **interconnection circuit branch**, **interconnection transformer branch**, the **HVDC link** or as a **shunt asset**.
- (6) After reviewing the interconnection asset capacity and grid configuration provided under subclause (1), the **Authority** may request **Transpower** to reconsider whether any of the interconnection asset capacity and grid configuration, is accurate, and require **Transpower** to resubmit the interconnection asset capacity and grid configuration to the **Authority** for reconsideration.

Compare: Electricity Governance Rules 2003 rules 2.1 to 2.6 section VI part F

Clause 12.107(2): replaced, on 5 October 2017, by clause 307(1) of the Electricity Industry Participation Code Amendment (Code Review Programme) 2017.

Clause 12.107(4): amended, on 5 October 2017, by clause 307(2) of the Electricity Industry Participation Code Amendment (Code Review Programme) 2017.

Clause 12.107(4)(c): amended, on 20 December 2021, by clause 51 of the Electricity Industry Participation Code Amendment (Code Review Programme) 2019. Clause 12.107(5): amended, on 5 October 2017, by clause 307(3) of the Electricity Industry Participation Code Amendment (Code Review Programme) 2017.

Clause 12.107(4)(c): amended, on 1 March 2024, by clause 63 of the Electricity Industry Participation Code Amendment (Code Review Programme) 2024.

12.108 Consultation on proposed interconnection asset capacity and grid configuration

- (1) If the **Authority** is provisionally satisfied that the interconnection asset capacity and grid configuration provided under clause 12.107(1) or resubmitted under clause 12.107(6) are correct, the **Authority** must **publish** the proposed interconnection asset capacity and grid configuration as soon as practicable for consultation with any person that the **Authority** thinks is likely to be materially affected by the incorporation of the proposed interconnection asset capacity and grid configuration by reference in this Code.
- (2) As well as the consultation required under subclause (1), the **Authority** may undertake any other consultation it considers necessary.

Compare: Electricity Governance Rules 2003 rules 2.7 and 2.8 section VI part F

12.109 Decision on interconnection asset capacity and grid configuration

- (1) When the **Authority** has completed its consultation on the proposed interconnection asset capacity and grid configuration, it must consider whether to incorporate the proposed interconnection asset capacity and grid configuration by reference in this Code.
- (2) If the **Authority** decides to incorporate the interconnection asset capacity and grid configuration by reference in this Code, the **Authority** must determine a date on which the incorporation by reference takes effect.

Compare: Electricity Governance Rules 2003 rule 2.9 section VI part F

Clause 12.109(2): amended, on 1 August 2023, by clause 45 of the Electricity Industry Participation Code Amendment (System Operation Documents) 2023.

12.110 Incorporation of interconnection asset capacity and grid configuration by reference

(1) The interconnection asset capacity and grid configuration is incorporated by reference in this Code.

(2) *[Revoked]*

Clause 12.110(1): amended, on 5 October 2017, by clause 308 of the Electricity Industry Participation Code Amendment (Code Review Programme) 2017.

Clause 12.110(1): amended, on 1 August 2023, by clause 46(1) of the Electricity Industry Participation Code Amendment (System Operation Documents) 2023.

Clause 12.110(2): revoked, on 1 August 2023, by clause 46(2) of the Electricity Industry Participation Code Amendment (System Operation Documents) 2023.

12.111 Transpower to make interconnection branches and other assets available and keep grid configuration

(1) **Transpower** must make each **interconnection circuit branch**, **interconnection transformer branch**, the **HVDC link**, and each **shunt asset** identified in the interconnection asset capacity and grid configuration available for use by the **system operator** for the conveyance of **electricity**—

(a) at least at the service levels specified in the interconnection asset capacity and grid configuration in accordance with clause 12.107(4); and

(b) in accordance with **good electricity industry practice** and relevant health and safety standards.

(2) **Transpower** must keep the **grid** in the configuration set out in the interconnection asset capacity and grid configuration.

(3) **Transpower** is not required to comply with subclauses (1)(a) or (2) if clause 12.112(1) applies.

Compare: Electricity Governance Rules 2003 rule 3 section VI part F

12.112 Exceptions to clause 12.111

(1) **Transpower** is not required to comply with clause 12.111(1)(a) or (2) if—

(a) permitted under the **Outage Protocol** made under subpart 7; or

(b) an **interconnection asset** that forms part of an interconnection **branch** or the **HVDC link**, or a **shunt asset**—

(i) is permanently removed from service, the **grid** is permanently reconfigured, or the transmission capacity of such an **asset** is reduced, and the decision to remove the **asset** from service or reconfigure the **grid** or reduce the transmission capacity of the **asset** takes into account the effect of the removal of the **asset**, reconfiguration of the **grid**, or the reduction in transmission capacity of the **asset**, on other materially affected parties, and is undertaken—

(A) in order to maintain the health and safety of any person; or

(B) in order to maintain the safety and integrity of equipment; or

(C) in accordance with demonstrably prudent economic criteria; or

(iaa) has been temporarily removed from service, or the **grid** has been

- temporarily reconfigured, in accordance with clause 12.116AA; or
 - (ia) *[Expired]*
 - (ii) has been permanently removed from service, or the **grid** has been permanently reconfigured, in accordance with clause 12.117; or
 - (c) a modification to an **interconnection branch**, the **HVDC link**, a **shunt asset** or to the configuration of the **grid**, has been made as a result of an investment in the **grid**; or
 - (d) a modification to an **interconnection branch**, the **HVDC link**, a **shunt asset** or to the configuration of the **grid** has been made as a result of an investment made under an **investment contract** entered into in accordance with clauses 12.70 and 12.71; or
 - (e) the voltage range specified in the **AOPOs** for an **interconnection asset** that forms part of an **interconnection branch** is modified, or any **equivalence arrangement** is approved or **dispensation** is granted under clauses 8.29 to 8.31 in respect of the **asset**; or
 - (ea) in relation to the **HVDC link**—
 - (i) the **HVDC owner** is operating the **HVDC link** in accordance with—
 - (A) a **commissioning** plan agreed with the **system operator** under clause 2(6) to (9) of **Technical Code A** of Schedule 8.3; or
 - (B) a test plan provided to the **system operator** under clause 2(6) to (9) of **Technical Code A** of Schedule 8.3; and
 - (ii) the **HVDC link configuration** is—
 - (A) Pole 3 and Pole 2 bipole **round power**; or
 - (B) Pole 3 and Pole 2 bipole not **round power**; or
 - (f) **Transpower** and a **designated transmission customer** have agreed otherwise in accordance with clause 12.128.
- (2) If subclause (1)(c) to (e) applies, or the **grid** is reconfigured under subclause (1)(b)(i) or (ii), **Transpower** must—
- (a) make the **interconnection branch**, the **HVDC link** or the **shunt asset** available to the **system operator** at least at its modified capacity rating, and at its modified service levels; and
 - (b) keep the **grid** in its modified configuration.
- (2AA) Subclause (2AB) applies—
- (a) if subclause (1)(b)(iaa) applies; and
 - (b) while—
 - (i) an **interconnection asset** that forms part of an **interconnection branch** or the **HVDC link**, or a **shunt asset**, has been temporarily removed; or
 - (ii) the **grid** has been temporarily reconfigured.
- (2AB) **Transpower** must make the **interconnection branch**, the **HVDC link** or the **shunt asset** available to the **system operator** at least at its modified capacity rating, and at its modified service levels.
- (2A) *[Expired]*
- (2B) *[Expired]*
- (3) If a decision to remove an **asset**, or reconfigure the **grid**, or reduce the transmission

capacity of an **asset** has been made under subclause (1)(b)(i) or (ii), **Transpower** must as soon as reasonably possible **publish** the analysis it undertook in accordance with subclause (1)(b)(i) or (ii), or a summary of that analysis.

Compare: Electricity Governance Rules 2003 rule 4 section VI part F

Clause 12.112(1)(b): amended, from 2 March 2012 to 3 December 2012, by clause 5(1) of the Electricity Industry Participation (Temporary Grid Reconfiguration) Code Amendment 2012.

Clause 12.112(1)(b)(i): amended, from 15 March 2013 to 15 December 2013, by clause 5(1)(a) of the Electricity Industry Participation (Temporary Grid Reconfiguration) Code Amendment 2013.

Clause 12.112(1)(b)(i): amended, on 16 December 2013, by clause 7(1) of the Electricity Industry Participation (Urgent Temporary Grid Reconfiguration) Code Amendment 2013.

Clause 12.112(1)(b)(iaa): inserted, from 15 March 2013 to 15 December 2013, by clause 5(1)(b) of the Electricity Industry Participation (Temporary Grid Reconfiguration) Code Amendment 2013.

Clause 12.112(1)(b)(iaa): inserted, on 16 December 2013, by clause 7(2) of the Electricity Industry Participation (Urgent Temporary Grid Reconfiguration) Code Amendment 2013.

Clause 12.112(1)(b)(ii): amended, from 15 March 2013 to 15 December 2013, by clause 5(1)(c) of the Electricity Industry Participation (Temporary Grid Reconfiguration) Code Amendment 2013.

Clause 12.112(1)(b)(ii): amended, on 16 December 2013, by clause 7(3) of the Electricity Industry Participation (Urgent Temporary Grid Reconfiguration) Code Amendment 2013.

Clause 12.112(1)(ea): inserted, on 26 September 2013, by clause 4 of the Electricity Industry Participation (HVDC Link Bipole Control System Testing) Code Amendment 2013.

Clause 12.112(1)(ea)(i)(A): amended, on 5 October 2017, by clause 309(1) of the Electricity Industry Participation Code Amendment (Code Review Programme) 2017.

Clause 12.112(2): amended, from 2 March 2012 to 3 December 2012, by clause 5(2) of the Electricity Industry Participation (Temporary Grid Reconfiguration) Code Amendment 2012.

Clause 12.112(2): amended, from 15 March 2013 to 15 December 2013, by clause 5(2) of the Electricity Industry Participation (Temporary Grid Reconfiguration) Code Amendment 2013.

Clause 12.112(2): amended, on 16 December 2013, by clause 7(4) of the Electricity Industry Participation (Urgent Temporary Grid Reconfiguration) Code Amendment 2013.

Clause 12.112(2): amended, on 5 October 2017, by clause 309(2) of the Electricity Industry Participation Code Amendment (Code Review Programme) 2017.

Clause 12.112(2AA) and (2AB): inserted, from 15 March 2013 to 15 December 2013, by clause 5(3) of the Electricity Industry Participation (Temporary Grid Reconfiguration) Code Amendment 2013.

Clause 12.112(2AA) and (2AB): inserted, on 16 December 2013, by clause 7(5) of the Electricity Industry Participation (Urgent Temporary Grid Reconfiguration) Code Amendment 2013.

Clause 12.112(2A) and (2B): inserted, from 2 March 2012 to 3 December 2012, by clause 5(3) of the Electricity Industry Participation (Temporary Grid Reconfiguration) Code Amendment 2012.

Clause 12.112(3): amended, from 15 March 2013 to 15 December 2013, by clause 5(4) of the Electricity Industry Participation (Temporary Grid Reconfiguration) Code Amendment 2013.

Clause 12.112(3): amended, on 16 December 2013, by clause 7(6) of the Electricity Industry Participation (Urgent Temporary Grid Reconfiguration) Code Amendment 2013.

Clause 12.112(3): amended, on 5 October 2017, by clause 309(3) of the Electricity Industry Participation Code Amendment (Code Review Programme) 2017.

Clause 12.112(1)(ea)(ii): amended, on 1 March 2024, by clause 63 of the Electricity Industry Participation Code Amendment (Code Review Programme) 2024.

12.113 Transpower to maintain interconnection assets

Transpower must design, construct, maintain and operate all **interconnection assets** in accordance with **good electricity industry practice**.

Compare: Electricity Governance Rules 2003 rule 5 section VI part F

Clause 12.113: amended, on 20 December 2021, by clause 52 of the Electricity Industry Participation Code Amendment (Code Review Programme) 2019.

Transpower to propose investments

12.114 Investments to meet the grid reliability standards

- (1) If a **grid reliability report** identifies, in accordance with clause 12.76(1)(c), that the power system is not reasonably expected to meet the **N-1 criterion** at a **grid exit point** at all times over the 5 years following the date on which the report is **published** and that this is due to

- an **interconnection asset**, **Transpower** must—
- (a) as soon as practicable, investigate whether the **interconnection asset** meets the **grid reliability standards**; and
 - (b) if the **interconnection asset** does not **meet** the **grid reliability standards**, consider reasonably practicable options for ensuring that the **grid reliability standards** can be met in respect of that asset; and
 - (c) if **Transpower** considers that 1 or more investments are required in respect of that **interconnection asset** in order to meet the **grid reliability standards**, submit an investment proposal to the Commerce Commission—
 - (i) in sufficient time to avoid a breach of the **grid reliability standards**; or
 - (ii) if the **grid reliability standards** have already been breached, within 6 months, or such longer period as the **Authority** may allow, after the publication of the **grid reliability report** that sets out the investment or investments that **Transpower** proposes to make; and
 - (d) if it considers that an investment is not necessary, **publish** the reasons for this and any alternative measures that **Transpower** proposes to undertake.
- (2) If an investment proposal submitted under this clause is approved by the Commerce Commission under section 54R of the Commerce Act 1986 or permitted under an input methodology determined under section 54S of that Act, **Transpower** must undertake the investment—
- (a) before the **grid** falls below the **grid reliability standards** for the reason referred to in subclause (1); or
 - (b) if the **grid** had already fallen below the **grid reliability standards**, or if it is not reasonably practicable to undertake the investment as provided in paragraph (a), as soon as reasonably practicable.
- (3) **Transpower** does not need to submit an investment proposal under subclause (1)(c) if the investment to which the proposal relates has previously been included in an investment proposal submitted to, and considered—
- (a) before this Code came into force, by the Electricity Commission under section III of part F of the **rules**; or
 - (b) after this Code came into force, by the Commerce Commission under section 54R or section 54S of the Commerce Act 1986.

Compare: Electricity Governance Rules 2003 rule 6.1 section VI part F

12.115 Other investments

- (1) **Transpower** must publish a **grid economic investment report** on whether there are investments that it considers, other than the investments identified under clause 12.114, could be made in respect of the **interconnection assets**.
- (2) **Transpower** must publish a **grid economic investment report** no later than 2 years after the date on which it published the previous **grid economic investment report**, or such other date as determined by the **Authority**.
- (3) If a **grid economic investment report** identifies that there are investments that could be made, **Transpower** must **publish** within 6 months a report setting out a proposed timetable for **Transpower** to consider whether to submit 1 or more investment proposals to the

Commerce Commission in respect of those possible investments.

- (4) The **grid economic investment report** does not need to report on possible investments that have been previously included in an investment proposal submitted to, and considered,—
- (a) before this Code came into force, by the Electricity Commission under section III of part F of the **rules**; or
 - (b) after this Code came into force, by the Commerce Commission under section 54R or section 54S of Part 4 of the Commerce Act 1986.

Compare: Electricity Governance Rules 2003 rule 6.2 section VI part F

12.116 Information on capacities of individual interconnection assets

- (1) **Transpower** must **publish** the following information in respect of each **interconnection asset**:
- (a) for each transformer that is an **interconnection asset**, the overall 24 hour post contingency capacity rating of the **asset** in amperes and MVA, for both the summer and winter periods:
 - (b) for all other **interconnection assets**, the overall capacity rating of the **asset** in amperes and MVA and, if the **interconnection assets** are circuits, for both the summer and winter periods.
- (2) The information required under subclause (1)—
- (a) must be consistent with the **manufacturer's specification** for the **asset** or with the most recent **asset capability statement** provided by **Transpower** under clause 2(5) of **Technical Code A** of Schedule 8.3, if this differs from the **manufacturer's specification**; and
 - (b) must be in a form that allows the **branch** to which each **asset** belongs to be easily identified; and
 - (c) must be **published** in the form determined by the **Authority** as soon as reasonably practicable after the **Authority** has determined the form.

Compare: Electricity Governance Rules 2003 rule 7 section VI part F

Clause 12.116(1): amended, on 5 October 2017, by clause 310(1) of the Electricity Industry Participation Code Amendment (Code Review Programme) 2017.

Clause 12.116(2)(b): amended, on 5 October 2017, by clause 310(2) of the Electricity Industry Participation Code Amendment (Code Review Programme) 2017.

Clause 12.116(2)(c): substituted, on 1 February 2016, by clause 55 of the Electricity Industry Participation Code Amendment (Code Review Programme) 2015.

12.116AA Temporary removal of interconnection assets from service or temporary grid reconfiguration

- (1) **Transpower** must temporarily remove 1 or more **interconnection assets** from service, or temporarily reconfigure the **grid** as permitted under clause 12.112(1)(b)(iaa), if—
- (a) the removal or reconfiguration is requested by the **system operator** in accordance with clause 9.13B; and
 - (b) the removal or reconfiguration will result in a net benefit, as calculated under the test set out in clause 12.117.
- (2) If **Transpower** temporarily removes **interconnection assets** from service or temporarily reconfigures the **grid** in response to a notice given under clause 9.13B, **Transpower** must, as soon as is reasonably practicable after the circumstances specified in that notice cease to exist—

- (a) restore the **interconnection assets** to service; or
- (b) restore the **grid** to its original configuration.

Clause 12.116AA: inserted, from 15 March 2013 to 15 December 2013, by clause 6 of the Electricity Industry Participation (Temporary Grid Reconfiguration) Code Amendment 2013.

Clause 12.116AA: inserted, on 16 December 2013, by clause 8 of the Electricity Industry Participation (Urgent Temporary Grid Reconfiguration) Code Amendment 2013.

Clause 12.116AA(1): amended, on 5 October 2017, by clause 311 of the Electricity Industry Participation Code Amendment (Code Review Programme) 2017.

12.116AB *[Expired]*

Clause 12.116AB: inserted, from 15 March 2013 to 15 December 2013, by clause 6 of the Electricity Industry Participation (Temporary Grid Reconfiguration) Code Amendment 2013.

12.116AC Information to be published

If **Transpower** receives a notice given in accordance with clause 9.13B, **Transpower** must **publish**,—

- (a) as soon as practical, a copy of the notice; and
- (b) by no later than **5 business days** after receiving the notice, a summary of **Transpower's** application of the net benefit test that relates to the exceptional circumstances stated in the notice.

Clause 12.116AC Heading: amended, on 5 October 2017, by clause 312(1) of the Electricity Industry Participation Code Amendment (Code Review Programme) 2017.

Clause 12.116AC: inserted, from 15 March 2013 to 15 December 2013, by clause 6 of the Electricity Industry Participation (Temporary Grid Reconfiguration) Code Amendment 2013.

Clause 12.116AC: inserted, on 16 December 2013, by clause 8 of the Electricity Industry Participation (Urgent Temporary Grid Reconfiguration) Code Amendment 2013.

Clause 12.116AC: amended, on 5 October 2017, by clause 312(2) of the Electricity Industry Participation Code Amendment (Code Review Programme) 2017.

12.116A *[Expired]*

Clause 12.116A: inserted, from 2 March 2012 to 3 December 2012, by clause 6 of the Electricity Industry Participation (Temporary Grid Reconfiguration) Code Amendment 2012.

12.116B *[Expired]*

Clause 12.116B: inserted, from 2 March 2012 to 3 December 2012, by clause 6 of the Electricity Industry Participation (Temporary Grid Reconfiguration) Code Amendment 2012.

12.116C *[Expired]*

Clause 12.116C: inserted, from 2 March 2012 to 3 December 2012, by clause 6 of the Electricity Industry Participation (Temporary Grid Reconfiguration) Code Amendment 2012.

12.117 Permanent removal of interconnection assets from service or permanent grid reconfiguration

- (1) **Transpower** may permanently remove **interconnection assets** from service or permanently reconfigure the **grid** as permitted under clause 12.112(1)(b) only if removal of the **asset** or reconfiguration of the **grid** results in a net benefit, as calculated under the test set out in subclause (2).
- (2) When **Transpower** is required to apply a net benefit test, **Transpower** must—
 - (a) estimate the following costs:
 - (i) any additional fuel costs incurred by a **generator** in respect of any **generating units** that will be **dispatched** or are likely to be **dispatched** during or after the removal of the **interconnection asset** or the

- reconfiguration of the **grid**, arising as a result of the removal or reconfiguration:
- (ii) any direct labour and material costs that will be incurred by **Transpower** and the **designated transmission customers** undertaking the removal of the **interconnection asset** or the reconfiguration of the **grid**:
 - (iii) any increase in the estimate of **expected unserved energy** in MWh multiplied by the value per MWh of that **expected unserved energy**, arising as a result of the removal of the **interconnection asset** or the reconfiguration of the **grid**:
 - (iv) any relevant cost specified in clause 12.43(1)(a)(iv):
 - (v) any other relevant cost to a person that produces, transmits, retails or consumes **electricity** in New Zealand; and
- (b) estimate the following benefits:
- (i) any reduction in maintenance costs arising as a result of the removal of the **interconnection asset** or the reconfiguration of the **grid** (including **Transpower's** and any **designated transmission customer's** costs):
 - (ii) any reduction in fuel costs incurred by a **generator** in respect of any **generating units**, arising or likely to arise during or after the removal of the **interconnection asset** or the reconfiguration of the **grid**, as a result of the removal or reconfiguration:
 - (iii) any decrease in the estimate of **expected unserved energy** in MWh multiplied by the value per MWh of that **expected unserved energy**, arising as a result of the removal of the **interconnection asset** or the reconfiguration of the **grid**:
 - (iv) any relevant benefit specified in clause 12.43(1)(b)(iv):
 - (v) any other relevant benefit to a person that produces, transmits, retails or consumes **electricity** in New Zealand; and
- (c) deduct the costs estimated under paragraph (a) from the benefits estimated under paragraph (b) to determine the net benefit of the proposed removal of the **interconnection asset** or the reconfiguration of the **grid**.
- (3) **Transpower** may apply the test under this clause at differing levels of rigour in different circumstances, which may include taking into account the number of **assets** to be removed or reconfigured, the value of the **assets** involved, and the size of the load served by the **assets**.
- (4) **Transpower** is only required to—
- (a) make a reasonable estimate of the costs and benefits identified in subclause (2), based on information reasonably available to it at the time it undertakes the test, and taking into account the proposed number of **assets** to be removed or reconfigured, the value of the **assets** involved, and the size of the load served by the **assets**; and
 - (b) take account of events that can be reasonably foreseen.
- (5) **Transpower's** estimate of fuel costs under subclause (2) must—
- (a) in relation to thermal **generating stations**, be a reasonable estimate of the fuel costs, based on the economic value of the fuel required for the relevant thermal

- generating station**, and justified by **Transpower** with reference to opinions on the economic value of the fuel, provided by 1 or more independent and suitably qualified persons; and
- (b) in relation to hydroelectric **generating stations**—
- (i) be a reasonable estimate of the fuel costs, based on the economic value of the water stored at a hydroelectric **generating station**, provided by a suitably qualified person other than—
- (A) **Transpower**; or
- (B) an employee of **Transpower**; and
- (ii) be **published**, as provided for in the **Outage Protocol**.
- (6) The direct labour costs of **Transpower** and **designated transmission customers** under subclause (2)(a) may include any amounts paid to contractors, but must not include any apportionment of the overheads or office costs of **Transpower** or **designated transmission customers**.
- (7) The material costs of **Transpower** and **designated transmission customers** under subclause (2)(a) are the costs of the materials used in carrying out the work during the removal of the **interconnection asset** or the reconfiguration of the **grid**.
- (8) In assessing the costs and benefits under subclause (2), **Transpower** must consider any reasonably expected operating conditions, forecasts in the **system security forecast**, likely fuel costs, and any other reasonable assumptions.
- (9) The estimate of **expected unserved energy** in MWh multiplied by the value per MWh of that **expected unserved energy** under subclause (2) must be based on the **value of expected unserved energy** in clause 4 of Schedule 12.2 and **Transpower's** estimate of the **expected unserved energy** in respect of each affected **designated transmission customer** and end use customer.
- (10) To avoid doubt, this clause applies to the removal of **interconnection assets** from service if **Transpower** does not propose to replace those **assets** with another **asset**.
- Compare: Electricity Governance Rules 2003 rule 8 section VI part F
Clause 12.117 Heading: amended, on 5 October 2017, by clause 313(1) of the Electricity Industry Participation Code Amendment (Code Review Programme) 2017.
Clause 12.117: substituted, on 16 December 2013, by clause 9 of the Electricity Industry Participation (Urgent Temporary Grid Reconfiguration) Code Amendment 2013.
Clause 12.117(1): amended, from 2 March 2012 to 3 December 2012, by clause 7 of the Electricity Industry Participation (Temporary Grid Reconfiguration) Code Amendment 2012.
Clause 12.117(1): amended, from 15 March 2013 to 15 December 2013, by clause 7 of the Electricity Industry Participation (Temporary Grid Reconfiguration) Code Amendment 2013.
Clause 12.117(1): amended, on 5 October 2017, by clause 313(2) of the Electricity Industry Participation Code Amendment (Code Review Programme) 2017.
Clause 12.117(9): amended, on 1 February 2016, by clause 56 of the Electricity Industry Participation Code Amendment (Code Review Programme) 2015.
Clause 12.117(9): amended, on 1 November 2018, by clause 79 of the Electricity Industry Participation Code Amendment (Code Review Programme) 2018.

12.118 Transpower to provide and publish annual report on interconnection asset capacity and grid configuration

- (1) **Transpower** must provide the **Authority** with and **publish** an annual report including—
- (a) any matter required to be reported on for the purposes of this clause by the **Outage Protocol**; and

- (b) the extent to which, in the preceding year ending 30 June, it has complied with the requirements of clause 12.111(1)(a) and (2); and
 - (c) any specific instances in which **Transpower** has not complied with clause 12.111(1)(a) and (2); and
 - (d) to the extent practicable, the circumstances that have given rise to any failure to comply with clause 12.111(1)(a) and (2); and
 - (e) to the extent practicable, any steps that it intends to take or other options to reduce the likelihood of failing to comply with clause 12.111(1)(a) and (2) in the future; and
 - (f) any modifications made to **interconnection circuit branches**, the **HVDC link**, and each **shunt asset** under clause 12.112(c) to (e) in the preceding year ending 30 June and the extent to which it has complied with clause 12.112(2) in respect of those modifications, including any specific instances in which **Transpower** has not complied; and
 - (g) any **interconnection assets** that have been removed from service, or any reconfigurations to the **grid** made, in accordance with clause 12.116AA or clause 12.117; and
 - (h) copies of any agreements made under clause 12.128 or, in respect of **interconnection assets** only, clause 12.151 in the preceding year ending 30 June; and
 - (i) an update of the interconnection asset capacity and grid configuration required under clause 12.107(1), as at the end of the preceding year ending 30 June.
- (2) **Transpower** must provide to the **Authority** and **publish**, the report referred to in subclause (1) by 30 November each year.
- (3) The **Authority** may incorporate by reference in this Code the updated interconnection asset capacity and grid configuration referred to in subclause (1)(i) in accordance with clause 12.110. The **Authority** may consult with any person the **Authority** considers is likely to be materially affected by the proposed amendments to the interconnection asset capacity and grid configuration, as it sees fit. **Transpower** must comply with the interconnection asset capacity and grid configuration incorporated by reference in this Code in accordance with clause 12.110.

Compare: Electricity Governance Rules 2003 rule 9 section VI part F

Clause 12.118(1)(g): amended, from 2 March 2012 to 3 December 2012, by clause 8 of the Electricity Industry Participation (Temporary Grid Reconfiguration) Code Amendment 2012.

Clause 12.118(1)(g): amended, from 15 March 2013 to 15 December 2013, by clause 8 of the Electricity Industry Participation (Temporary Grid Reconfiguration) Code Amendment 2013.

Clause 12.118(1)(g): amended, on 16 December 2013, by clause 10 of the Electricity Industry Participation (Urgent Temporary Grid Reconfiguration) Code Amendment 2013.

Clause 12.118(1): amended, on 5 October 2017, by clause 314(1) of the Electricity Industry Participation Code Amendment (Code Review Programme) 2017.

Clause 12.118(2): amended, on 5 October 2017, by clause 314(2) of the Electricity Industry Participation Code Amendment (Code Review Programme) 2017.

Reporting on availability and reliability

12.119 Index measures for availability and reliability

The index measures for availability and reliability for each **interconnection branch**, **shunt asset** and the **HVDC link** are the index measures for reliability for each

interconnection branch, shunt asset and the **HVDC link** in Schedule 12.5.

12.120 Updating of availability and reliability index measures

- (1) This clause applies if **interconnection assets**—
 - (a) are modified or replaced as permitted under clause 12.112(1); or
 - (b) have been damaged or degraded but, after conducting the investigation required under clause 12.114(1), **Transpower** considers that they still meet the **grid reliability standards**.
- (2) If this clause applies, if, after the availability and the reliability or availability index measures for an **interconnection branch, shunt asset** and the **HVDC link** or aggregated **interconnection branches** or **shunt assets** no longer meet the requirements of clause 12.122, the availability and reliability index measures in Schedule 12.5 must be updated following the procedure specified in clauses 12.121 to 12.127.
- (3) **Transpower** must propose the revised index measures under clause 12.121 within 20 **business days** of the modification or replacement, or such longer period as the **Authority** may allow.

Compare: Electricity Governance Rules 2003 rule 10.9 section VI part F

12.121 Transpower to submit draft index measures for availability and reliability

- (1) **Transpower** must provide the **Authority** with proposed index measures for availability and reliability for each **interconnection branch, shunt asset** and the **HVDC link**, in accordance with this clause.
- (2) For the purposes of subclause (1), **Transpower** must categorise **interconnection branches** and **shunt assets** into groups of **interconnection branches** and **shunt assets** comprising similar **assets**.
- (3) The index measures to be provided under subclause (1) are—
 - (a) annual unavailability of each **interconnection branch, shunt asset** and the **HVDC link** due to **planned outages** of 1 minute or longer in hours per year ending 30 June, expressed as a percentage; and
 - (b) annual unavailability of each **interconnection branch, shunt asset** and the **HVDC link** due to **unplanned outages** of 1 minute or longer in hours per year ending 30 June, expressed as a percentage; and
 - (c) annual number of **planned interruptions** of 1 minute or longer caused by **planned outages** of 1 minute or longer of each **interconnection branch, shunt asset** and the **HVDC link**; and
 - (d) annual number of **unplanned interruptions** of 1 minute or longer caused by **unplanned outages** of 1 minute or longer of each **interconnection branch, shunt asset** and the **HVDC link**;
 - (e) total unserved energy per year ending 30 June in **MWh** resulting from **planned interruptions** of 1 minute or longer caused by **planned outages** of 1 minute or longer of each **interconnection branch, shunt asset** and the **HVDC link**; and
 - (f) total unserved energy per year ending 30 June in **MWh** resulting from **unplanned interruptions** of 1 minute or longer caused by **unplanned outages** of 1 minute or longer of each **interconnection branch, shunt asset** and the **HVDC link**.

- (4) At the same time, **Transpower** must propose availability and reliability index measures for aggregated **interconnection branches** and **shunt assets**, such as by **asset** class or for all of the **grid**.

Compare: Electricity Governance Rules 2003 rule 10.1 section VI part F

Clause 12.121(2): amended, on 5 October 2017, by clause 315(1) of the Electricity Industry Participation Code Amendment (Code Review Programme) 2017.

Clause 12.121(3): amended, on 5 October 2017, by clause 315(2) of the Electricity Industry Participation Code Amendment (Code Review Programme) 2017.

12.122 Requirements for index measures

- (1) The proposed availability and reliability index measures under clause 12.121(3) must be based on the average annual availability and reliability of each category of **interconnection branch**, or **shunt asset** and of the **HVDC link** over the 5 year period (ending 30 June) immediately before this clause came into force.
- (2) The proposed index measures under clause 12.121(3) must be accompanied by an explanation showing how the requirements of subclause (1) were applied.
- (3) The index measure for unserved energy under clause 12.121(3)(e) and (f) must be determined in accordance with the methodology for determining **expected unserved energy** relating to **outages of interconnection assets** specified in the **Outage Protocol**.
- (4) In proposing the availability and reliability index measures under clause 12.121(4), **Transpower** must specify its reasons for proposing those measures.

Compare: Electricity Governance Rules 2003 rule 10.2 section VI part F

Clause 12.122(1): amended, on 5 October 2017, by clause 316 of the Electricity Industry Participation Code Amendment (Code Review Programme) 2017.

12.123 Authority may initially approve proposed index measures or refer back to Transpower

After considering **Transpower's** proposed availability and reliability index measures and accompanying reasons the **Authority** may either—

- (a) provisionally approve the proposed availability and reliability index measures; or
- (b) refer the proposed availability and reliability index measures and accompanying explanation back to **Transpower** if in the **Authority's** view—
- (i) the proposed availability and reliability index measures under clause 12.121 are not consistent with the requirements of clause 12.122(1) or the methodology referred to in clause 12.122(3); or
- (ii) the proposed availability and reliability index measures under clause 12.121 do not provide sufficient information to meet the reasonable needs of **grid** users; or
- (iii) the reasons provided with the availability and reliability targets in accordance with clause 12.122 are inadequate—

and **Transpower** must within 20 **business days** (or such longer period as the **Authority** may allow) consider the **Authority's** concerns and resubmit the proposed availability and reliability index measures and accompanying explanations for consideration by the **Authority**.

Compare: Electricity Governance Rules 2003 rule 10.3 section VI part F

12.124 Amendment of proposed index measures by the Authority

If the **Authority** considers that the availability and reliability index measures resubmitted by **Transpower** under clause 12.123(b) are not consistent with the requirements of clause 12.122(1) or the methodology referred to in clause 12.122(3), or do not provide relevant information to **grid** users, the **Authority** may make any amendments to the index measures it considers necessary.

Compare: Electricity Governance Rules 2003 rule 10.4 section VI part F

12.125 Authority must consult on proposed index measures

- (1) The **Authority** must **publish** the proposed availability and reliability index measures, either as provisionally approved by the **Authority** or as amended by the **Authority**, as soon as is practicable, for consultation with any person that the **Authority** thinks is likely to be materially affected by the proposed index measures.
- (2) As well as the consultation required under subclause (1), the **Authority** may undertake any other consultation it considers necessary.

Compare: Electricity Governance Rules 2003 rules 10.5 and 10.6 section VI part F

12.126 Decision on index measures

When the **Authority** has completed its consultation on the proposed availability and reliability measures it must consider whether to include the index measures as a schedule to this Part.

Compare: Electricity Governance Rules 2003 rule 10.7 section VI part F

12.127 Transpower to report on availability and reliability

- (1) By 30 November in each year, **Transpower** must **publish** and provide to the **Authority** information on availability and reliability of **interconnection assets** including—
 - (a) annual unavailability of each **interconnection branch, shunt asset** and the **HVDC link** due to **planned outages** of 1 minute or longer in the preceding year ending 30 June in hours per year expressed as a percentage; and
 - (b) annual unavailability of each **interconnection branch, shunt asset** and the **HVDC link** due to **unplanned outages** of 1 minute or longer in the preceding year ending 30 June in hours per year, expressed as a percentage; and
 - (c) annual number of **planned interruptions** of 1 minute or longer caused by **planned outages** of one minute or longer of each **interconnection branch, shunt asset** and the **HVDC link** in the preceding year ending 30 June; and
 - (d) annual number of **unplanned interruptions** of 1 minute or longer caused by **unplanned outages** of 1 minute or longer of each **interconnection branch, shunt asset** and the **HVDC link** in the preceding year ending 30 June; and
 - (e) total unserved energy in the preceding year ending 30 June resulting from **planned interruptions** of 1 minute or longer caused by **planned outages** of 1 minute or longer of **interconnection branches, shunt assets** and the **HVDC link**; and
 - (f) total unserved energy in the preceding year ending 30 June resulting from **unplanned interruptions** of 1 minute or longer caused by **unplanned outages** of

- 1 minute or longer of **interconnection branches, shunt assets** and the **HVDC link**; and
- (g) annual number of **outages** of each **interconnection branch, shunt asset** and the **HVDC link** that are shorter than 1 minute in the preceding year ending 30 June; and
 - (h) the annual number of **interruptions** shorter than 1 minute caused by **outages** that are shorter than 1 minute of each **interconnection branch, shunt asset** and the **HVDC link**, in the preceding year ending 30 June; and
 - (i) a comparison of the information required by paragraphs (a) to (f) against the availability and reliability index measures for **interconnection branches, shunt assets** and the **HVDC link** included in a schedule to this Part under clause 12.126;
 - (j) to the extent practicable, an explanation of the reasons for not meeting the reliability and availability index measures for **interconnection branches, shunt assets** and the **HVDC link** included in a schedule to this Part under clause 12.126 and any steps or other options it intends to take in future to meet the index measures; and
 - (k) information on its performance against the reliability and availability index measures for aggregated **interconnection branches** included in a schedule to this Part under clause 12.126.
- (2) The information **published** under subclause (1) must be specified in the same units of measurement as the corresponding index measures included in a schedule to this Part under clause 12.126.
- (3) **Transpower** does not breach this Code by reason of a failure to meet the index measures included in a schedule to this Part under clause 12.126.

Compare: Electricity Governance Rules 2003 rule 10.8 section VI part F
Clause 12.127(1): amended, on 5 October 2017, by clause 317 of the Electricity Industry Participation Code Amendment (Code Review Programme) 2017.

12.128 Transpower and designated transmission customers may agree on other requirements

- (1) **Transpower** and each **designated transmission customer** must comply with this Part, unless agreed otherwise by **Transpower** and the **designated transmission customer** in respect of specified **interconnection circuit branches, the HVDC link, shunt assets or interconnection assets**, or the **designated transmission customer** in accordance with subclause (2).
- (2) An agreement between **Transpower** and a **designated transmission customer** under this clause must not exclude the application of subclause (3)(b) and must be conditional in all respects on—
 - (a) obtaining agreement from all other potentially affected **designated transmission customers** that this Part does not apply to the specified **interconnection circuit branches, the HVDC link, shunt assets or interconnection assets**, or the **designated transmission customer**; and
 - (b) **Transpower** and the **designated transmission customer** confirming in writing to the **Authority** that they have consulted with all potentially affected end use customers on this Part not applying to the specified **interconnection branches**,

circuit branches, the HVDC link, shunt assets or interconnection assets or the **designated transmission customer**, and that there are no material unresolved issues affecting the interests of those end use customers.

- (3) **Transpower** must—
- (a) give written notice to the **Authority** as soon as practicable if **Transpower** enters into an agreement with a **designated transmission customer** under this clause; and
 - (b) **publish** the agreement no later than 20 **business days** after entering into the agreement.

Compare: Electricity Governance Rules 2003 rule 11 section VI part F

Clause 12.128(2): amended, on 5 October 2017, by clause 318(a) of the Electricity Industry Participation Code Amendment (Code Review Programme) 2017.

Clause 12.128(3): replaced, on 5 October 2017, by clause 318(b) of the Electricity Industry Participation Code Amendment (Code Review Programme) 2017.

Subpart 7—Preparation of Outage Protocol

12.129 Purpose of this subpart

The purpose of this subpart is to provide for the making of an **Outage Protocol**, with input from **Transpower** and in consultation with other interested parties, that—

- (a) specifies the circumstances in which **Transpower** may temporarily remove any **assets** forming part of the **grid** from service or reduce the capacity of assets to efficiently manage the operation of the **grid**; and
- (b) specifies procedures and policies for **Transpower** to plan for **outages** and for carrying out such **outages** to—
 - (i) ensure **Transpower** involves **designated transmission customers** in making decisions on **planned outages** as much as possible; and
 - (ii) ensure coordination between **Transpower** and **designated transmission customers**; and
 - (iii) enable **Transpower** to efficiently manage the operation of the **grid**; and
- (c) specifies procedures and policies for dealing with **unplanned outages** of the **grid**.

Compare: Electricity Governance Rules 2003 rule 1 section VII part F

12.130 Definition of outage

- (1) An **outage** exists when **interconnection assets** or **connection assets** are temporarily not provided in accordance with—
 - (a) the requirements of a **transmission agreement**; or
 - (b) the requirements of subpart 6.
- (2) Without limiting subclause (1), an **outage** includes any situation in which—
 - (a) **Transpower** removes **assets** from service temporarily; or
 - (b) **assets** are not able to be provided due to **grid emergencies**, in order to deal with health and safety issues, or due to circumstances beyond **Transpower's** reasonable control; or
 - (c) **Transpower** reduces the capacity of **branches** below the capacity required by a **transmission agreement** or clause 12.111; or
 - (d) **Transpower** changes the configuration of the **grid**; or
 - (e) **Transpower** is required by law to carry out an **outage**.

Compare: Electricity Governance Rules 2003 rule 2 section VII part F

12.131 Outage Protocol

- (1) The **Outage Protocol** set out in schedule F7 of section VII of part F of the **rules** immediately before this Code came into force, continues in force and is deemed to be the **Outage Protocol** that applies at the commencement of this Code, with the following amendments:
 - (a) every reference to the Board must be read as a reference to the **Authority**;
 - (b) every reference to the **rules** must be read as a reference to the Code;
 - (c) every reference to a provision of the **rules** must be read as a reference to the corresponding provision of the Code;
 - (d) the reference in clause 3.1.2(d), clause 3.3.5(c), and clause 3.3.8(a) to a reliability investment or an economic investment approved by the Board must be read as a reference to an **approved investment**;
 - (e) the reference in clause 10.2.1(a) and (b) to the **benchmark agreement** in schedule F2 must be read as a reference to the **default transmission agreement template**;
 - (f) the reference in clauses A1.1(a)(ii), A7.2(a)(ii), and A7.2(b)(i) to the value of unserved energy in clause 8.3.4 of schedule F4 of section III must be read as a reference to the **value of expected unserved energy** in clause 4 of Schedule 12.2;
 - (g) the reference in clauses A6.1(f) and A6.2(e) to the matters specified in clauses 27.1 to 27.9 of schedule F4 of section III must be read as the matters specified in clause 12.43(1)(a)(iv) and (b)(iv);
 - (h) the reference in clause A8.1(a)(i) to fuel costs specified in the statement of opportunities must be read as a reference to fuel costs calculated in accordance with clause 12.141(3)(a)(i).
- (2) The **Authority** must as soon as practicable after this Code comes into force, publish a version of the **Outage Protocol** in which the provisions of this Code that correspond to the provisions of the **rules** referred to in the **Outage Protocol** are shown.
- (3) Clause 12.150 applies to the **Outage Protocol**.
Clause 12.131(1)(e): amended, on 1 October 2023, by clause 36 of the Electricity Industry Participation Code Amendment (Default Transmission Agreement) 2023

Review of Outage Protocol

12.132 Review of Outage Protocol

The **Authority** may review the **Outage Protocol** at any time, in accordance with the requirements of clauses 12.133 and 12.145 to 12.149.

Compare: Electricity Governance Rules 2003 rule 14 section VII part F

12.133 Transpower to submit proposed Outage Protocol

- (1) **Transpower** must submit a proposed **Outage Protocol** to the **Authority** within 3 months (or such longer period as the **Authority** may allow) of receipt of a written request from the **Authority**. The **Authority** may issue such a request at any time.
- (2) The proposed **Outage Protocol** must give effect to or promote the principles set out in clause 12.134 and provide for the matters set out in clauses 12.135 to 12.144.

- (3) With its proposed **Outage Protocol**, **Transpower** must submit to the **Authority** an explanation of the proposed **Outage Protocol** and a **statement of proposal** for the proposed **Outage Protocol**.

Compare: Electricity Governance Rules 2003 rule 8 section VII part F

Principles and required content of Outage Protocol

12.134 Principles for developing Outage Protocol

The **Outage Protocol** must give effect to the following principles:

- (a) the matters in clause 12.129;
- (b) the need for a fair and reasonable balance of interests between the **grid owner** and **designated transmission customers**;
- (c) the need to ensure that the **grid owner** can meet all obligations placed on it by the **system operator** for the purpose of meeting common security and power quality requirements under Part 8 of this Code;
- (d) the need to ensure that the safety of all personnel is maintained;
- (e) the need to ensure that the safety and integrity of equipment is maintained;
- (f) the desirability of the **Outage Protocol** and Part 8 operating in an integrated and consistent manner, if possible.

Compare: Electricity Governance Rules 2003 rule 3 section VII part F

12.135 Required content of Outage Protocol

- (1) The **Outage Protocol** must—
 - (a) require **Transpower** to plan for **outages**, other than **outages** that are not reasonably foreseeable, in accordance with clause 12.136; and
 - (b) require **Transpower** and **designated transmission customers** to act reasonably and in good faith in planning for **outages**, in accordance with clause 12.137; and
 - (c) set out the situations and times at which **Transpower** must reconsider the timing of proposed **planned outages**, as specified in clause 12.138; and
 - (d) permit **Transpower** to vary a proposed **planned outage**, as specified in clause 12.139;
 - (e) set out the requirements for **Transpower** to consider when planning for **outages**, in order to give effect to the net benefit principle, as specified in clause 12.140; and
 - (f) permit **Transpower** to undertake **outages** in order to give effect to an **approved investment**, and to undertake **outages** that are required by the Electricity Act 1992, as specified in clause 12.142; and
 - (g) permit **Transpower** to undertake **outages**, or take such other steps, as the **system operator** may reasonably require.
- (2) The **Outage Protocol** must require **Transpower** to set out the procedures and policies for dealing with **unplanned outages**, as specified in clause 12.143.
- (3) The **Outage Protocol** must require **Transpower** to report on compliance with the **Outage Protocol**, in accordance with clause 12.144.
- (4) The **Outage Protocol** must set out—

- (a) processes for **Transpower** to consult with **designated transmission customers** and to determine an **outage plan** setting out **planned outages** for each year ending 30 June, and processes for the **outage plan** to be updated; and
 - (b) requirements on **Transpower** to keep **designated transmission customers** informed about **planned outages**, including minimum notice periods for **Transpower** to advise affected **designated transmission customers** of **planned outages** not set out in the **outage plan**; and
 - (c) procedures for **outage** co-ordination by **Transpower** and between **Transpower** and **designated transmission customers**; and
 - (d) requirements on **Transpower** to provide information to **designated transmission customers** about **unplanned outages**.
- (5) The **Outage Protocol** is not limited to the matters referred to in this clause, and may provide for any other matters related to **outages**.

Compare: Electricity Governance Rules 2003 rule 4 section VII part F

Clause 12.135(4)(a): amended, on 5 October 2017, by clause 319 of the Electricity Industry Participation Code Amendment (Code Review Programme) 2017.

12.136 Planning for outages

The **Outage Protocol** must require **Transpower** to plan for **outages**, other than **outages** that are not reasonably foreseeable—

- (a) in respect of **interconnection assets**, in accordance with the requirements of the **Outage Protocol** specified under clause 12.140(1); and
- (b) in respect of **connection assets**, by agreeing with each affected **designated transmission customer** on the timing and duration of the **outage** or, failing agreement, in accordance with the requirements of the **Outage Protocol** specified under clause 12.140(1); and
- (c) in respect of outages of both **interconnection assets** and **connection assets** that are required in order to give effect to an **approved investment** or are required by the Electricity Act 1992, in accordance with the requirements of the **Outage Protocol** specified under clause 12.142.

Compare: Electricity Governance Rules 2003 rule 5.1 section VII part F

12.137 Transpower and designated transmission customers to act reasonably and in good faith

- (1) The **Outage Protocol** must require **Transpower**, in planning for **outages** in accordance with clauses 12.136, 12.140, and 12.142, reconsidering the timing of proposed **planned outages** in accordance with clause 12.138 or varying proposed **planned outages** in accordance with clause 12.139, to act reasonably and in good faith, taking into account the information reasonably known at the time or that can be reasonably forecast.
- (2) The **Outage Protocol** must require **designated transmission customers**, in exercising rights or undertaking obligations under the **Outage Protocol**, to act reasonably and in good faith.

Compare: Electricity Governance Rules 2003 rule 5.2 section VII part F

12.138 Reconsideration of planned outages

The **Outage Protocol** must set out the situations and the times at which **Transpower** must reconsider the timing of proposed **planned outages**, and the extent to which the proposed timing of **planned outages** needs to be reconsidered, which may include—

- (a) whenever material new information has been provided to **Transpower** about the likely effect of a proposed **planned outage**; and
- (b) whenever circumstances relating to a proposed **planned outage** have changed sufficiently to justify reconsideration of the requirements specified under clauses 12.140 or 12.142, and **Transpower** is aware or has been made aware of the change in circumstances.

Compare: Electricity Governance Rules 2003 rule 5.3 section VII part F

12.139 Variations to planned outages

- (1) The **Outage Protocol** may permit **Transpower** to vary a proposed **planned outage** only if—
 - (a) in respect of a proposed **planned outage** of **interconnection assets**, the variation of the proposed **planned outage** is permitted in accordance with the requirements of the **Outage Protocol** specified under clauses 12.140 or 12.142; or
 - (b) in respect of a proposed **planned outage** of **connection assets**, **Transpower** and each affected **designated transmission customer** agree on the variation as provided for in the **Outage Protocol** or, failing agreement, the variation of the proposed **planned outage** is permitted in accordance with the requirements of the **Outage Protocol** specified under clauses 12.140 or 12.142; or
 - (c) the variation is necessary as a result of a **grid emergency**, in order to deal with health and safety issues, in order to comply with the **Act** or due to other circumstances beyond **Transpower's** reasonable control; or
 - (d) the variation is required to meet a request of the **system operator** that **Transpower** vary a proposed **planned outage**.
- (2) The **Outage Protocol** must require **Transpower**, if possible, to give notice of a variation before the proposed **planned outage**, and if prior notice is not possible, to advise of the variation to the proposed **planned outage** as soon as possible after the variation occurs.

Compare: Electricity Governance Rules 2003 rule 5.4 section VII part F

12.140 Net benefit principle, requirements and methodologies

- (1) The requirements of the **Outage Protocol** relating to planning for **outages** under clause 12.136(a) or (b), or for varying proposed **planned outages** under clause 12.139(1)(a) or (b)—
 - (a) must give effect to the net benefit principle specified in subclause (2), in determining the timing and duration of a **planned outage**, and whether to undertake a **planned outage**, either by including the particular requirements set out in clause 12.141(2), or by some other means; and

- (b) may include methodologies and processes for **Transpower** to apply when planning for **outages**; and
- (c) may include other requirements that may apply in different situations.
- (2) The net benefit principle is that, in planning and varying a **planned outage**, **Transpower** must ensure that the **planned outage** is likely to result in net benefits to persons who produce, transmit, distribute, retail or consume **electricity**—
 - (a) in respect of **interconnection assets**, to the extent those persons are affected by an **outage**; and
 - (b) in respect of **connection assets**, if **Transpower** has not agreed the timing and duration of the **outage** with the relevant **designated transmission customer** in accordance with the **Outage Protocol**, to the extent those persons are affected by an **outage**.

Compare: Electricity Governance Rules 2003 rule 5.5 section VII part F

12.141 Consideration of likely effects of planned outages

- (1) The **Outage Protocol** may require **Transpower** to determine the likely effect of a proposed **planned outage** on the power system, **generators** and **consumers**, and—
 - (a) if a proposed **outage** is not reasonably expected to—
 - (i) result in the power system failing to meet the **grid reliability standards**; and/or
 - (ii) give rise to **binding constraints**; and/or
 - (iii) result in loss of supply to **consumers**, may permit **Transpower** to undertake the **outage**; and
 - (b) if a proposed **outage** is likely to result in, or give rise to, the matters referred to in paragraph (a), the **Outage Protocol** may require **Transpower** to comply with the particular requirements specified in subclause (2).
- (2) The requirements in subclause (1) that the **Outage Protocol** may provide are—
 - (a) if a proposed **planned outage** is likely to result in the power system failing to meet the **grid reliability standards**, but is not expected to give rise to **binding constraints** or result in loss of **supply** to **consumers**, **Transpower** must—
 - (i) estimate the following costs:
 - (A) any direct labour and material costs that **Transpower** will incur in undertaking the **outage**;
 - (B) any direct labour and material costs that **designated transmission customers** will incur as a result of **Transpower** undertaking the **outage**;
 - (C) if the **outage** will result in an increased risk of loss of **supply**, any increase in the estimate of **expected unserved energy** in MWh multiplied by the value per MWh of that **expected unserved energy**;
 - (D) any relevant cost specified in clause 12.43(1)(a)(iv);
 - (E) any other relevant cost to a person that produces, transmits, retails or consumes **electricity** in New Zealand; and
 - (ii) estimate the following benefits:

- (A) if the **outage** will result in a decreased risk of loss of **supply**, any decrease in the estimate of **expected unserved energy** in MWh multiplied by the value per MWh of that **expected unserved energy**;
 - (B) any reduction in maintenance costs arising as a result of the **outage** (including **Transpower's** and any **designated transmission customer's** costs);
 - (C) any relevant benefit specified in clause 12.43(1)(b)(iv);
 - (D) any other relevant benefit to a person that produces, transmits, retails or consumes **electricity** in New Zealand; and
- (iii) carry out the **outage** only if the costs estimated under subparagraph (i) are less than the benefits estimated under subparagraph (ii); and
- (b) if a proposed planned **outage** is likely to give rise to **binding constraints**, whether or not the **outage** is also likely to result in a loss of **supply** to **consumers**, **Transpower** must—
- (i) estimate the following costs:
 - (A) any direct labour and material costs that **Transpower** will incur in undertaking the **outage**;
 - (B) any direct labour and material costs that **designated transmission customers** will incur as a result of **Transpower** undertaking the **outage**;
 - (C) if the **outage** will result in an increased risk of loss of **supply**, any increase in the estimate of **expected unserved energy** in MWh multiplied by the value per MWh of that **expected unserved energy**;
 - (D) any additional fuel costs incurred by a **generator** in respect of any **generating units** that will be **dispatched** or are likely to be **dispatched** during or after the **outage** and as a result of the **outage**;
 - (E) any relevant cost specified in clause 12.43(1)(a)(iv);
 - (F) any other relevant costs to a person that produces, transmits, retails or consumes **electricity** in New Zealand; and
 - (ii) estimate the following benefits:
 - (A) any reduction in maintenance costs resulting from the **outage** (including **Transpower's** and any **designated transmission customer's** costs);
 - (B) any reduction in fuel costs incurred by a **generator** in respect of any **generating units**, arising or likely to arise during or after the **outage** and as a result of the **outage**;
 - (BA) if the **outage** will result in a decreased risk of loss of **supply**, any decrease in the estimate of **expected unserved energy** in MWh multiplied by the value per MWh of that **expected unserved energy**;
 - (C) any relevant benefit specified in clause 12.43(1)(b)(iv);
 - (D) any other relevant benefit to a person that produces, transmits, retails or consumes **electricity** in New Zealand; and
 - (iii) carry out the **outage** only if the costs estimated under subparagraph (i) are less than the benefits estimated under subparagraph (ii); and

- (c) if a proposed planned **outage** is likely to lead to loss of **supply** to **consumers**, whether or not the **outage** is also likely to give rise to **binding constraints**, **Transpower** must—
- (i) estimate the following costs:
 - (A) any direct labour and material costs that **Transpower** will incur in undertaking the **outage**:
 - (B) any direct labour and material costs that **designated transmission customers** will incur as a result of **Transpower** undertaking the **outage**:
 - (C) any increase in the estimate of **expected unserved energy** in MWh multiplied by the value per MWh of that **expected unserved energy**, arising from the loss of **supply** during the **outage**:
 - (CA) any additional fuel costs incurred by a **generator** in respect of any **generating units** that will be **dispatched** or are likely to be **dispatched** during or after the **outage** and as a result of the **outage**:
 - (D) any relevant cost specified in clause 12.43(1)(a)(iv):
 - (E) any other relevant cost to a person that produces, transmits, retails or consumes **electricity** in New Zealand; and
 - (ii) estimate the following benefits:
 - (A) any reduction in maintenance costs resulting from the **outage** (including **Transpower's** and any **designated transmission customer's** costs):
 - (B) if the **outage** will result in a decreased risk of loss of **supply**, any decrease in the estimate of **expected unserved energy** in MWh multiplied by the value per MWh of that **expected unserved energy**:
 - (C) any reduction in fuel costs incurred by a **generator** in respect of any **generating units**, arising or likely to arise during or after the **outage** and as a result of the **outage**:
 - (D) any relevant benefit specified in clause 12.43(1)(b)(iv):
 - (E) any other relevant benefit to a person that produces, transmits, retails or consumes **electricity** in New Zealand; and
 - (iii) carry out the **outage** only if the costs estimated under subparagraph (i) are less than the benefits estimated under subparagraph (ii).
- (3) In providing for the matters referred to in subclause (2), the **Outage Protocol** must include the following requirements:
- (a) **Transpower's** estimate of the fuel costs under subclause (2)(b) and (c) must—
 - (i) in relation to thermal **generating stations**, be a reasonable estimate of the fuel costs, based on the economic value of the fuel required for the relevant thermal **generating station**, and justified by **Transpower** with reference to opinions on the economic value of the fuel, provided by 1 or more independent and suitably qualified persons; and
 - (ii) in relation to hydroelectric **generating stations**—

- (A) be a reasonable estimate of the fuel costs, based on the economic value of the water stored at a hydroelectric **generating station**, provided by a suitably qualified person other than—
 - (1) **Transpower**; or
 - (2) an employee of **Transpower**; and
 - (B) be **published**, as provided for in the **Outage Protocol**:
 - (b) the direct labour costs of **Transpower** and **designated transmission customers** under subclause (2) may include any amounts paid to contractors, but must not include any apportionment of the overheads or office costs of **Transpower** or **designated transmission customers**:
 - (c) the material costs of **Transpower** and **designated transmission customers** under subclause (2) are the costs of the materials used in carrying out the work during the **outage**:
 - (d) the estimate of **expected unserved energy** in MWh multiplied by the value per MWh of that **expected unserved energy** under subclause (2) must—
 - (i) in the case of **connection assets**, be based on—
 - (A) the estimated amount and value of the **expected unserved energy** as agreed between **Transpower** and each affected **designated transmission customer**; or
 - (B) if **Transpower** and a **designated transmission customer** cannot agree on the amount and value of the **expected unserved energy** under subparagraph (A), the **value of expected unserved energy** in clause 4 of Schedule 12.2 and **Transpower's** estimate of the **expected unserved energy** in respect of each affected **designated transmission customer** and end use customer; and
 - (ii) in the case of **interconnection assets**, be based on—
 - (A) the **value of expected unserved energy** in clause 4 of Schedule 12.2; and
 - (B) **Transpower's** estimate of the **expected unserved energy** in respect of each affected **designated transmission customer** and end use customer.
- (4) In addition to the requirements in subclause (3), the **Outage Protocol** must require **Transpower**, in planning for **outages**, to consider any reasonably expected operating conditions, forecasts in the **system security forecast**, likely fuel costs, and any other reasonable assumptions.
- (5) The **Outage Protocol** must include a methodology for determining **expected unserved energy** for the purposes of subclause (2)(a) to (c) that complies with subclauses (3)(d) and (4).
- (6) The **Outage Protocol** may permit **Transpower** to—
 - (a) make only a reasonable estimate of the matters specified in subclauses (2) to (4) based on information reasonably available to it at the time **Transpower** considers whether to carry out a **planned outage**, and taking into account the number of **assets** to which the proposed **outage** applies, the value of the **assets** involved, the size of the load served by the **assets**, the proposed duration of the **outage**; and

- (b) apply differing levels of rigour in different circumstances, which may include taking into account the number of **assets** to which a proposed **outage** applies, the value of the **assets** involved, the size of the load served by the **assets**, the proposed duration of the **outage**, and any other relevant matters.

Compare: Electricity Governance Rules 2003 rule 5.6 section VII part F

Clause 12.141 heading: amended, on 20 December 2021, by clause 53 of the Electricity Industry Participation Code Amendment (Code Review Programme) 2019.

Clause 12.141(2) to (4): substituted, on 16 December 2013, by clause 11 of the Electricity Industry Participation (Urgent Temporary Grid Reconfiguration) Code Amendment 2013.

Clause 12.141(3)(d)(i)(B): amended, on 1 February 2016, by clause 57(1) of the Electricity Industry Participation Code Amendment (Code Review Programme) 2015.

Clause 12.141(3)(d)(i)(B): amended, on 1 November 2018, by clause 80 of the Electricity Industry Participation Code Amendment (Code Review Programme) 2018.

Clause 12.141(3)(d)(ii)(A): amended, on 1 February 2016, by clause 57(2) of the Electricity Industry Participation Code Amendment (Code Review Programme) 2015.

Clause 12.141(3)(d)(ii)(B): amended, on 1 November 2018, by clause 80 of the Electricity Industry Participation Code Amendment (Code Review Programme) 2018.

12.142 Planned outages required in order to give effect to an investment or required by the Act

- (1) The **Outage Protocol** must set out requirements for **Transpower** to consider when determining the timing of **planned outages** that are required in order to give effect to an **approved investment** or that are required by the Electricity Act 1992.
- (2) The requirements specified under subclause (1) must require **Transpower** to give effect to the net benefit principle in clause 12.140(2) in determining the timing and duration of **outages** subject to this clause, and may require **Transpower** to consider some or all of the costs and benefits specified in clause 12.141.

Compare: Electricity Governance Rules 2003 rule 5.7 section VII part F

12.143 Required content of Outage Protocol in relation to unplanned outages

- (1) The **Outage Protocol** must—
 - (a) set out procedures and policies for dealing with **unplanned outages**, so as to minimise the costs and, if relevant, maximise the benefits arising from an **unplanned outage**; and
 - (b) set out the reasonable steps and measures that **Transpower** must take in order to be prepared for **unplanned outages**, so as to ensure that it is readily able to deal with **unplanned outages** in a way that minimises the costs and, if relevant, maximises the benefits arising from an **unplanned outage**; and
 - (c) require **Transpower** to deal with **unplanned outages** as quickly as reasonably possible, in accordance with the procedures specified in the **Outage Protocol**.
- (2) The costs and benefits under subclause (1) are the costs and benefits of the **outage** to persons who produce, transmit, distribute, retail, or consume **electricity**.

Compare: Electricity Governance Rules 2003 rule 6 section VII part F

12.144 Reporting on compliance with Outage Protocol

The **Outage Protocol** must require **Transpower** to publish and report to **designated transmission customers** and the **Authority**, whether in the report provided under clause 12.118 or otherwise, on its compliance with the requirements of the **Outage**

Protocol, including the requirements specified in clause 12.140(1) for giving effect to the net benefit principle specified in clause 12.140(2) and the requirements of the **Outage Protocol** relating to **unplanned outages** specified in clause 12.143.

Compare: Electricity Governance Rules 2003 rule 7 section VII part F

Decisions on Outage Protocol

12.145 Authority may initially approve the proposed Outage Protocol or refer back to Transpower

After consideration of **Transpower's** proposed **Outage Protocol** and accompanying explanation and **statement of proposal**, the **Authority** may—

- (a) provisionally approve the proposed **Outage Protocol** having regard to the principles in clause 12.134 and the matters set out in clauses 12.135 to 12.144; or
- (b) refer the proposed **Outage Protocol** and accompanying explanation and regulatory statement back to **Transpower**, if in the **Authority's** view—
 - (i) the proposed **Outage Protocol** does not adequately give effect to or promote the principles in clause 12.134; or
 - (ii) the proposed **Outage Protocol** does not adequately provide for the matters set out in clauses 12.135 to 12.144; or
 - (iii) the explanation or **statement of proposal** provided with the **Outage Protocol** in accordance with clause 12.133(3) is not adequate—

and **Transpower** must, within 20 **business days** (or such longer period as the **Authority** may allow), consider the **Authority's** concerns and resubmit its proposed **Outage Protocol** and accompanying explanation and **statement of proposal** for reconsideration by the **Authority**.

Compare: Electricity Governance Rules 2003 rule 9 section VII part F

12.146 Reconsideration of revised Outage Protocol by the Authority

After reconsideration of **Transpower's** proposed **Outage Protocol**, and accompanying explanation and **statement of proposal**, as revised under clause 12.145(b), the **Authority** may either—

- (a) provisionally approve the proposed **Outage Protocol**, as revised, having regard to the principles in clause 12.134 and the matters set out in clauses 12.135 to 12.144; or
- (b) if the **Authority** considers that the **Outage Protocol** resubmitted by **Transpower** under clause 12.145(b) does not adequately give effect to or promote the principles in clause 12.134, or adequately provide for the matters set out in clauses 12.135 to 12.144, the **Authority** may make any amendments to the proposed **Outage Protocol**, as revised, that it considers necessary.

Compare: Electricity Governance Rules 2003 rule 10 section VII part F

12.147 Authority must consult on the proposed Outage Protocol

The **Authority** must **publish** the proposed **Outage Protocol**, either as provisionally approved by the **Authority** or as amended by the **Authority**, as soon as is practicable,

for consultation with any person that the **Authority** thinks is likely to be materially affected by the proposed **Outage Protocol**.

Compare: Electricity Governance Rules 2003 rule 11 section VII part F

12.148 Authority may undertake additional consultation

As well as the consultation required under clause 12.147, the **Authority** may undertake any other consultation it considers necessary.

Compare: Electricity Governance Rules 2003 rule 12 section VII part F

12.149 Decision on Outage Protocol

- (1) When the **Authority** has completed its consultation on the proposed **Outage Protocol**, it must consider whether to incorporate the proposed **Outage Protocol** by reference as the **Outage Protocol**.
- (2) If the **Authority** decides to incorporate the **Outage Protocol** by reference in this Code, the **Authority** must determine a date on which the incorporation by reference takes effect.

Compare: Electricity Governance Rules 2003 rule 13 section VII part F

Clause 12.149(2): amended, on 1 August 2023, by clause 47 of the Electricity Industry Participation Code Amendment (System Operation Documents) 2023.

12.150 Incorporation of Outage Protocol by reference

- (1) The **Outage Protocol** is incorporated by reference in this Code.
- (2) *[Revoked]*

Clause 12.150(1): amended, on 5 October 2017, by clause 320(1) of the Electricity Industry Participation Code Amendment (Code Review Programme) 2017.

Clause 12.150(1): amended, on 1 August 2023, by clause 48(1) of the Electricity Industry Participation Code Amendment (System Operation Documents) 2023.

Clause 12.150(2): amended, on 5 October 2017, by clause 320(2) of the Electricity Industry Participation Code Amendment (Code Review Programme) 2017.

Clause 12.150(2): revoked, on 1 August 2023, by clause 48(2) of the Electricity Industry Participation Code Amendment (System Operation Documents) 2023.

Complying with Outage Protocol

12.151 Compliance with Outage Protocol

- (1) **Transpower** and each **designated transmission customer** must comply with the **Outage Protocol**, unless agreed otherwise by **Transpower** and a **designated transmission customer** in respect of specified **assets** or the **designated transmission customer** in accordance with subclause (2).
- (2) An agreement between **Transpower** and a **designated transmission customer** to which the **Outage Protocol** does not apply in respect of specified **assets** must not exclude the application of subclause (3)(b) and must be conditional in all respects on—
 - (a) obtaining agreement from all other potentially affected **designated transmission customers** that the **Outage Protocol** does not apply in respect of the specified **assets** or the **designated transmission customer**; and
 - (b) **Transpower** and the **designated transmission customer** satisfying the **Authority** that they have consulted with all potentially affected end use customers on the **Outage Protocol** not applying in respect of the specified **assets** or the

designated transmission customer and that there are no material unresolved issues affecting the interests of those end use customers.

(3) **Transpower** must—

- (a) give written notice to the **Authority** as soon as practicable if **Transpower** enters into an agreement with a **designated transmission customer** under this clause; and
- (b) **publish** the agreement no later than 20 **business days** after entering into the agreement.

Compare: Electricity Governance Rules 2003 rule 15 section VII part F

Clause 12.151(2): amended, on 5 October 2017, by clause 321(a) of the Electricity Industry Participation Code Amendment (Code Review Programme) 2017.

Clause 12.151(3): replaced, on 5 October 2017, by clause 321(b) of the Electricity Industry Participation Code Amendment (Code Review Programme) 2017.

Schedule 12.1

Categories of designated transmission customers

cl 12.7

1 Categories of designated transmission customers required to enter into transmission agreements with Transpower

- (1) The categories of **designated transmission customers** required to enter into **transmission agreements with Transpower** are—
 - (a) **connected asset owners**; and
 - (b) *[Revoked]*
 - (c) **generators** that are directly connected to the **grid**.
- (2) *[Revoked]*
- (3) *[Revoked]*
- (4) *[Revoked]*
- (5) *[Revoked]*

Compare: Electricity Governance Rules 2003 schedule F1 part F

Schedule 12.1, clause 1(1): amended, on 16 December 2013, by clause 9(1) of the Electricity Industry Participation (Revocation of Part 16) Code Amendment 2013.

Schedule 12.1, clause 1(1)(a): amended, on 1 February 2016, by clause 58(1) of the Electricity Industry Participation Code Amendment (Code Review Programme) 2015.

Schedule 12.1, clause 1(1)(b): revoked, on 1 February 2016, by clause 58(2) of the Electricity Industry Participation Code Amendment (Code Review Programme) 2015.

Schedule 12.1, clause 1(1)(c): amended, on 23 February 2015, by clause 75 of the Electricity Industry Participation Code Amendment (Distributed Generation) 2014.

Schedule 12.1, clause 1(1)(c): amended, on 5 October 2017, by clause 322 of the Electricity Industry Participation Code Amendment (Code Review Programme) 2017.

Schedule 12.1, clause 1(2) to (5): revoked, on 16 December 2013, by clause 9(2) of the Electricity Industry Participation (Revocation of Part 16) Code Amendment 2013.

Schedule 12.2

Grid reliability standards

cl 12.55

1 Preamble

Clause 12.55 of this Code, requires the **Authority** to determine the most appropriate **grid reliability standards** and in so doing must have regard to the purposes in clause 12.56 and the principles set out in clause 12.57, as required by clause 12.55.

Compare: Electricity Governance Rules 2003 clause 2 schedule F3 part F

2 The grid reliability standards

- (1) The purpose of the **grid reliability standards** is to provide a basis for **Transpower** and other parties to appraise opportunities for transmission investments and **transmission alternatives**.
- (2) For the purpose of subclause (1), the **grid** satisfies the **grid reliability standards** if—
 - (a) the power system is reasonably expected to achieve a level of reliability at or above the level that would be achieved if all **economic reliability investments** were to be implemented; and
 - (b) with all **assets** that are reasonably expected to be in service, the power system would remain in a **satisfactory state** during and following a **single credible contingency event** occurring on the **core grid**.
- (3) For the purpose of subclause (2)(a), the expected level of reliability of the power system must be assessed at each and every **grid exit point** and **grid injection point** (wherever located on the **grid**).
- (4) For the purpose of subclause (2)(a) and (b), the expected level of reliability, and state, of the power system must be assessed using the range of relevant operating conditions that could reasonably be expected to occur.

Compare: Electricity Governance Rules 2003 clauses 3 to 6 schedule F3 part F

3 Interpretation and definitions

- (1) For the purposes of these **grid reliability standards**, unless the context calls for another interpretation—
 - (a) the terms defined in Part 1 of this Code take that defined meaning; and
 - (b) the term defined in subclause (2) takes that defined meaning; and
 - (c) a reference—
 - (i) to the singular includes the plural and conversely; and
 - (ii) to a person includes an individual, company, other body corporate, association, partnership, firm, joint venture, trust, or Government Agency; and
 - (d) the word including or includes means including, but not limited to, or includes, without limitation; and
 - (e) the other grammatical forms of the term defined in subclause (2) have a corresponding meaning.
- (2) **Economic reliability investments** means investments in the **grid** and **transmission**

alternatives that would satisfy the economic test for an investment proposal applied by the Commerce Commission under Part 4 of the Commerce Act 1986—

- (a) assuming that the economic test was applied to both investments in the **grid and transmission alternatives**; and
- (b) having regard to Parts 7 and 8 (including the **policy statement**).

Compare: Electricity Governance Rules 2003 clauses 7 and 8 schedule F3 part F

4 Value of expected unserved energy

- (1) The value of any **expected unserved energy** is—
 - (a) \$20,000 per **MWh**; or
 - (b) such other value as the **Authority** may determine.
- (2) The **Authority** may determine different **values of expected unserved energy** under this clause for different purposes and for different times.
- (3) If the **Authority** determines a **value of expected unserved energy** under this clause, the **Authority** must **publish** its determination.

Schedule 12.2, clause 4(1): amended, on 1 February 2016, by clause 59(1) of the Electricity Industry Participation Code Amendment (Code Review Programme) 2015.

Schedule 12.2, clause 4(2): amended, on 1 February 2016, by clause 59(2) of the Electricity Industry Participation Code Amendment (Code Review Programme) 2015.

Schedule 12.2, clause 4(3): amended, on 1 February 2016, by clause 59(3) of the Electricity Industry Participation Code Amendment (Code Review Programme) 2015.

Schedule 12.3 Core grid determination

cl 12.63

1 Background

Clause 12.63 of this Code, requires the **Authority** to determine the most appropriate **core grid determination** and in so doing to have regard to the purposes set out in clause 12.64, the principles set out in clause 12.57 for the **grid reliability standards** and the objectives set out in clause 12.65.

Compare: Electricity Governance Rules 2003 clause 2 schedule F3A part F

2 The core grid determination

- (1) The purpose of this **core grid determination** is to define the **core grid** for the purposes of the **grid reliability standards** and so provide a basis for—
 - (a) the **Authority** to determine the **grid reliability standards**; and
 - (b) **Transpower** and other parties to appraise opportunities for transmission investment and **transmission alternatives**.
- (2) The **core grid** consists of those assets that comprise the transmission links listed in Table 1 below:

Table 1

North Island core grid links	South Island core grid links
220kV Huapai-Marsden	220kV Islington-Kikiwa
220kV Huapai-Bream Bay	220kV Kikiwa-Stoke
220kV Bream Bay-Marsden	220kV Twizel-Tekapo B
110kV Marsden-Maungatapere	220kV Tekapo B-Islington
220 kV Henderson-Huapai	220kV Twizel-Opihi-Timaru-Ashburton
220 kV Albany-Huapai	220kV Ashburton-Bromley
220 kV Albany-Henderson	220kV Bromley-Islington
110kV Albany-Henderson	220kV Twizel-Opihi-Timaru-Islington
110kV Henderson-Hepburn Rd	220kV Livingstone-Islington
220kV Otahuhu-Henderson	220kV Benmore-Ohau B
220kV Otahuhu-Southdown	220kV Ohau B-Twizel
220kV Southdown-Henderson	220kV Benmore-Twizel
220kV Otahuhu-Penrose	220kV Benmore-Ohau C
110kV Mangere-Roskill	220kV Ohau C-Twizel
110kV Otahuhu-Roskill	220kV Benmore-Aviemore
110kV Otahuhu-Pakuranga	220kV Clyde-Cromwell
110kV Otahuhu-Wiri	220kV Cromwell-Twizel
220kV Otahuhu-Takanini	220kV Roxburgh-Clyde
220kV Huntly-Takanini	220kV Naseby-Livingstone
110kV Wiri-Bombay	220kV Roxburgh-Naseby
220kV Huntly-Glenbrook	220kV Roxburgh-Three Mile Hill

Electricity Industry Participation Code 2010
Schedule 12.3

North Island core grid links	South Island core grid links
220kV Glenbrook-Takanini	220kV Three Mile Hill-Half Way Bush
220kV Otahuhu-Whakamaru	220kV Three Mile Hill-Sth Dunedin
220kV Otahuhu-Huntly	220kV Sth Dunedin-Half Way Bush
220kV Huntly-Hamilton	220kV Manapouri-Invercargill
110kV Mt Maunganui-Tarukenga	220kV Manapouri-Nth Makarewa
110kV Tarukenga-Tauranga	220kV Nth Makarewa-Invercargill
220kV Tarukenga-Edgecumbe	220kV Invercargill-Roxburgh
220kV Edgecumbe-Kawerau	220kV Invercargill-Tiwai Pt
220kV Kawerau-Ohakuri	220kV Nth Makarewa-Tiwai Pt
220kV Wairakei-Ohakuri	220/66kV interconnection Islington
220kV Ohakuri-Atiamuri	66kV Islington-Addington
220kV Atiamuri-Tarukenga	220/66kV interconnection Bromley
220kV Atiamuri-Whakamaru	
220kV Wairakei-Redclyffe	
220kV Wairakei-Whirinaki	
220kV Whirinaki-Redclyffe	
220kV Hamilton-Whakamaru	
220kV Tokaanu-Whakamaru	
220kV Bunnythorpe-Tokaanu	
220kV Bunnythorpe-Tangiwai	
220kV Rangipo-Tangiwai	
220kV Rangipo-Wairakei	
220kV Wairakei-Poihipi	
220kV Poihipi-Whakamaru	
220kV Stratford-New Plymouth	
110kV New Plymouth-Carrington St	
220kV Bunnythorpe-Haywards	
220kV Haywards-Wilton	
220kV Haywards- Linton	
220kV Wilton-Linton	
220kV Bunnythorpe-Linton	
110kV Wilton-Central Park	
110kV Takapu Rd-Wilton	
220kV Bunnythorpe-Brunswick	
220kV Brunswick-Stratford	
110kV Otahuhu-Mangere	
110kV Haywards-Takapu Rd	
220/110kV interconnection Marsden	
220/110kV interconnection Albany	
220/110kV interconnection Henderson	
220/110kV interconnection Penrose	
220/110kV interconnection Otahuhu	
220/110kV interconnection Hamilton	
220/110kV interconnection Tarukenga	

North Island core grid links	South Island core grid links
220/110kV interconnection New Plymouth 220/110kV interconnection Stratford 220/110kV interconnection Redclyffe 220/110kV interconnection Bunnythorpe 220/110kV interconnection Haywards 220/110kV interconnection Wilton	

Compare: Electricity Governance Rules 2003 clauses 3 and 4 schedule F3A part F

3 Interpretation

For the purposes of this **core grid determination**, unless the context calls for another interpretation, a term has the meaning given to that term in the **grid reliability standards**.

Compare: Electricity Governance Rules 2003 clause 5 schedule F3A part F

Schedule 12.4 Transmission Pricing Methodology

Schedule 12.4: replaced, on 20 December 2022, by clause 4 of the Electricity Industry Participation Code Amendment (Transmission Pricing Methodology) 2022.

Part A Preliminary

- 1 Purpose
- 2 Overview of Transmission Charges
- 3 General Definitions
- 4 Load Customers, Gross Energy and Maximum Gross Demand
- 5 Commissioning
- 6 Connection and Disconnection
- 7 Large Plant
- 8 Interpretation
- 9 Transmission Charges Calculated Separately
- 10 Calculations and Estimations
- 11 Determinations
- 12 Reverse Flow
- 13 Exceptional Operating Circumstances
- 14 Applications, Application Fees and Application Requirements
- 15 Consultation on Transmission Charges
- 16 Information about Transmission Charges

Part B Grid Asset Classification

- 17 Grid Assets and Land and Buildings
- 18 Partial Funding of Grid Assets
- 19 Nodes and Links
- 20 Connection and Interconnection Nodes and Links
- 21 Connection and Interconnection Assets
- 22 Associating Connection Assets with Connection Locations and Customers
- 23 Discretion to Classify and Reclassify as Connection Asset

Part C Connection Charges

- 24 Calculation of Connection Charges
- 25 Start of Connection Charges
- 26 Asset Component
- 27 Anticipatory BBIs
- 28 Funded Asset Component

29	Funded Asset Rebate
30	Maintenance Component
31	Operating Component
32	Connection Customer Allocations
33	De-rating
34	Replacement Costs
Part D	Benefit-based Charges
35	Calculation of Benefit-based Charges
36	Start of Benefit-based Charges
37	Expenditure on Existing BBIs
38	Assumptions Book
39	Covered Cost
40	Attributed Opex Component
40A	Commissioned Assets Not Asseted
41	Covered Cost of Anticipatory BBI
42	BBI Customer Allocations for Appendix A BBIs
43	BBI Customer Allocations for Post-2019 BBIs
44	Overview of Price-quantity Method
45	Factual and Counterfactual
46	Scenarios
47	Individual NPB
48	Present Value of Regional NPB
49	Modelling for Market Regional NPB
50	Modelled Regions and Regional Customer Groups
51	Calculation of Market Regional NPB based on Quantity
52	Calculation of Market Regional NPB based on Price and Quantity
53	Ancillary Service Regional NPB
54	Reliability Regional NPB
55	Other Regional NPB
56	Overview of Resiliency Method
57	Individual NPB
58	Modelled Region and Regional Customer Group
59	Overview of Simple Method
60	Simple Method Periods
61	Individual NPB
62	Modelled Regions

63	Regional Customer Groups
64	Regional NPB
64A	Publication of Simple Method Information
65	Intra-regional Allocators
66	Recent Customers
67	Notional IRA Value
Part E	Residual Charges
68	Calculation of Residual Charges
69	Anytime Maximum Demand (Residual)
70	Anytime Maximum Demand (Residual) Baseline
71	Residual Charge Adjustment Factor
72	Reduction Events
73	Re-estimating for Recent Load Customers
74	Residual Charge Rate
Part F	Adjustments
75	Adjustment Events
76	Connection Charge Adjustment Events
77	Connection Charge Adjustment Event: Connecting Customer
78	Connection Charge Adjustment Event: Disconnecting Customer
79	Connection Charge Adjustment Event: Sale of Business
80	Connection Charge Adjustment Event: Voluntary Under-recovery
81	Benefit-based Charge Adjustment Events
82	Benefit-based Charge Adjustment Event: Material Damage
83	Benefit-based Charge Adjustment Event: New Customer
84	Benefit-based Charge Adjustment Event: Exiting Customer
85	Benefit-based Charge Adjustment Event: Large Plant Connected or Disconnected
86	Benefit-based Charge Adjustment Event: Substantial Sustained Increase
87	Benefit-based Charge Adjustment Event: Distributor Connection at Grid Point of Connection
88	Benefit-based Charge Adjustment Event: Changed Point of Connection
89	Benefit-based Charge Adjustment Event: Sale of Business
90	Benefit-based Charge Adjustment Event: Voluntary Under-recovery
91	Benefit-based Charge Adjustment Event: SSCGU
92	Residual Charge Adjustment Events
93	Residual Charge Adjustment Event: Exiting Load Customer
94	Residual Charge Adjustment Event: Sale of Business

95 Residual Charge Adjustment Event: Voluntary Under-recovery

Part G Reassignment

96 Effect of Reassignment

97 Reassignment Amount

98 Eligibility for Reassignment

99 Reassignment Application

100 Application Screening and Publication

101 Assessment

102 Forecast Peak Loading and Reassignment Factors

103 Consultation on Draft Decision

104 Decision and Independent Review

105 Decision to be Published

106 Commercially Sensitive Information

107 Reversal for Increased Forecast Peak Loading

108 Reversal for Subsequent Write-Down

109 Application Fees, Application Requirements and Reassignment Practice Manual

Part H Transitional Price Cap

110 Cap and Cap Condition

111 Difference Cap

112 Cap Recovery Charge

Part I Prudent Discount Policy

113 Effect of Prudent Discount Agreements

114 Prudent Discount Applications

115 Application Screening and Publication

116 Assessment

117 Calculation of Alternative Project Costs

118 Assessment of Commercial Viability

119 Consultation on Draft Decision

120 Decision and Independent Review

121 Prudent Discount Agreement

122 Back-dated Prudent Discounts

123 Calculation of Annuity

124 Decision to be Published

125 Commercially Sensitive Information

126 Application Fees, Application Requirements and Prudent Discount Practice Manual

127 Purpose of Inefficient Bypass Prudent Discount

- 128 Multiple Benefitting Customers
- 129 Assessment of Equivalence, Feasibility and Commercial Viability
- 130 Assessment whether the Alternative Project is Inefficient
- 131 Approval or Rejection of Inefficient Bypass Prudent Discount Application
- 132 Impact on Transmission Charges
- 133 Purpose of Stand-alone Cost Prudent Discount
- 134 Assessment of Equivalence, Feasibility and Commercial Viability
- 135 Assessment of Efficient Stand-alone Investment²¹⁶
- 136 Approval or Rejection of Stand-alone Cost Prudent Discount Application
- 137 Impact on Transmission Charges
- 138 Prudent Discount Recovery Charges

Part A Preliminary

Introduction

1 Purpose

The **transmission pricing methodology** is used to recover the cost of **transmission services** provided by **Transpower**, other than costs recovered under **investment agreements**, but not more than **recoverable revenue** for each **pricing year**. This **transmission pricing methodology** allocates that cost to **customers** through **transmission charges**.

2 Overview of Transmission Charges

The **transmission charges** are—

- (a) **connection charges**, which recover part of **recoverable revenue** by reference to the cost of **connection investments**. Part C specifies how **connection charges** are calculated; and
- (b) **benefit-based charges**, which recover part of **recoverable revenue** by reference to the **covered cost** of **benefit-based investments**. Part D specifies how **benefit-based charges** are calculated; and
- (c) **cap recovery charges**, which are a redistribution of **transmission charges** that would otherwise be payable by **capped customers** who are receiving **cap reductions**; and
- (d) **prudent discount recovery charges**, which are a redistribution of **transmission charges** that would otherwise be payable by **prudent discount recipients**; and
- (e) **residual charges**, which recover the remainder of **recoverable revenue**. Part E specifies how **residual charges** are calculated.

Clause 2(a): amended, on 31 July 2023, by clause 4(1) of the Electricity Industry Participation Code Amendment (Transmission Pricing Methodology Amendments) 2023.

Clause 2(b): amended, on 31 July 2023, by clause 4(2) of the Electricity Industry Participation Code Amendment (Transmission Pricing Methodology Amendments) 2023.

Clause 2(e): amended, on 31 July 2023, by clause 4(3) of the Electricity Industry Participation Code Amendment (Transmission Pricing Methodology Amendments) 2023.

Interpretation

3 General Definitions

In this **transmission pricing methodology**, unless the context otherwise requires—

2020 guidelines means the guidelines the **Authority** published under paragraph 12.83(b) of this Code on 10 June 2020

AC assets means **grid assets** other than **HVDC assets**

AC switch means a switch that is an **AC asset**

accelerated depreciation means **depreciation** or tax depreciation (as the context requires) of an asset exclusively due to damage to, or destruction, stranding, decommissioning or disposal of, the asset

adjustment event means a **connection charge adjustment event**, **benefit-based charge adjustment event** or **residual charge adjustment event**

alleviated price means, for a **regional customer group**, **factual** and **counterfactual**, a price at a **market node** in the **regional customer group's modelled region** that, due to a **modelled constraint** is—

- (a) higher in the **counterfactual** than the **factual**; or
- (b) higher in the **counterfactual** than a price at another **market node** in the **counterfactual** that is in a **modelled region** for a different **regional customer group** of the same type (**regional demand group** or **regional supply group**)

allocation data means any data about **supply, demand, injection, offtake** or **gross energy** that affects a **customer's** allocation of **transmission charges**

allowance means, for a cost or charge over a period, the forecast MAR building block under the **Transpower IPP** over the period for the cost or charge

alternative project means—

- (a) for an **inefficient bypass prudent discount**, an investment by the **customer** in a **transmission alternative** that, if implemented, would bypass existing **grid assets**; or
- (b) for a **stand-alone cost prudent discount**, an investment in the **grid** or 1 or more **transmission alternatives** by an efficient **transmission services** provider that, if implemented, would provide **transmission services** in substitution for all **transmission services** the **customer** currently receives

alternative project costs has the meaning in clause 117

ancillary service BBI means a **post-2019 BBI** that is expected to have a material impact on prices or quantities in the **wholesale market** for a **specified ancillary service** relative to the **post-2019 BBI's counterfactual**. An **ancillary service BBI** may also be a **market BBI** or **reliability BBI**, but cannot be a **resiliency BBI**

ancillary service regional customer group means a **regional customer group** defined in subclause 53(3)

ancillary service regional NPB means **regional NPB** arising from changes in prices or quantities in the **wholesale market** for a **specified ancillary service**. **Ancillary service regional NPB** may be calculated for **ancillary service BBIs**

annual benefit-based charge has the meaning in subclause 35(2)

annual cap recovery charge has the meaning in subclause 112(1)

annual charges means the following **transmission charges** for a **customer** and **pricing year**:

- (a) **annual connection charges**;
- (b) **annual benefit-based charges**;
- (c) **annual cap recovery charge**;
- (d) **annual prudent discount recovery charge**;
- (e) **annual residual charge**

annual connection charge has the meaning in subclause 24(2) or 24(3)

annual prudent discount recovery charge has the meaning in subclause 138(5)

annual residual charge has the meaning in subclause 68(2)

anticipatory BBI has the meaning in subclause 27(2)

anticipatory connection asset has the meaning given in subclause 26(3)

anytime maximum demand (connection) or **AMDC** means, for a **customer, connection location** and **pricing year**, the average of the 12 highest **offtake** quantities for the **customer** at the **connection location** during **CMP A** for the **pricing year**, multiplied by 2 to convert to average demand

anytime maximum demand (residual) or AMDR means the amount calculated under clause 69 for a **load customer** and **pricing year**

anytime maximum injection (connection) or AMIC means, for a **customer, connection location** and **pricing year**, the average of the 12 highest **injection** quantities for the **customer** at the **connection location** during **CMP A** for the **pricing year**, multiplied by 2 to convert to average **supply**

Appendix A allocation means, for an **Appendix A customer** and **Appendix A BBI** and subject to clause 10(8), the **Appendix A customer's BBI customer allocation** for the **Appendix A BBI** specified in Appendix A to 2 decimal places

Appendix A BBI means the following **interconnection investments**:

Bunnythorpe Haywards the **interconnection investment** approved by the **Commission** on 9 May 2014 as the Bunnythorpe-Haywards A and B Lines Conductor Replacement Project, including all amendments to that approved project subsequently approved by the **Commission**

HVDC all **interconnection investments** in the **HVDC link commissioned** on or before 23 July 2019

LSI Reliability the **interconnection investment** approved by the Electricity Commission on 6 September 2010 as the Lower South Island Reliability Transmission Investment, including all amendments to that approved project subsequently approved by the Electricity Commission or **Commission**

LSI Renewables the **interconnection investment** approved by the Electricity Commission on 9 August 2010 as the Lower South Island Renewables Investment, including all amendments to that approved project subsequently approved by the Electricity Commission or **Commission**, but excluding the **post-2019 CUWLP investment**

NIGU the **interconnection investment** approved by the Electricity Commission on 5 July 2007 as the North Island Grid Upgrade, including all amendments to that approved project subsequently approved by the Electricity Commission or **Commission**

UNIDRS the **interconnection investment** approved by the Electricity Commission on 5 July 2010 as the Upper North Island Dynamic Reactive Support Investment, including all amendments to that approved project subsequently approved by the Electricity Commission or **Commission**

Wairakei Ring the **interconnection investment** approved by the Electricity Commission on 20 February 2009 as the Wairakei Ring Investment, including all amendments to that approved project subsequently approved by the Electricity Commission or **Commission**

Appendix A beneficiary means, for an **Appendix A BBI**, an **Appendix A customer** who has a positive **Appendix A allocation** for the **Appendix A BBI**

Appendix A customer means a person specified in Appendix A, even if not a current **customer** at the time this definition is applied

application means an application to **Transpower** under this **transmission pricing methodology**, including an application for a **prudent discount** or **reassignment**

application fee means a fee for a type of **application published** by **Transpower**, if any

application requirements means, for an **application**, the content requirements for the **application published** by **Transpower**

asseted means, for an asset comprised in a **BBI**, that there is sufficient information about the asset in **Transpower's** fixed asset register for **Transpower** to calculate accurately the part of the **BBI's covered cost** for a **pricing year** that relates to the asset

Clause 3 **asseted**: inserted, on 31 July 2023, by clause 5(3) of the Electricity Industry Participation Code Amendment (Transmission Pricing Methodology Amendments) 2023.

assumptions book means a document **published** by **Transpower** containing assumptions and detailed methodologies that **Transpower**—

- (a) intends to apply for allocating and adjusting **benefit-based charges**; and
- (b) does not expect to vary between **BBI**s except according to the method (**standard method, simple method** or Appendix A) used to calculate their **BBI customer allocations**

avoided charges means—

- (a) for an **inefficient bypass prudent discount**—
 - (i) the **transmission charges** the relevant **customer** would avoid paying if the relevant **alternative project** were implemented—
 - (A) assessed relative to the **transmission charges** the **customer** would pay if the **alternative project** were not implemented; and
 - (B) assuming none of the **alternative project costs** for the **alternative project** would be recovered through **transmission charges**; less
 - (ii) the absolute value of any reduction in **settlement residue** that would be paid to the **customer** if the **alternative project** were implemented, assessed relative to the **settlement residue** that would be paid to the **customer** if the **alternative project** were not implemented; and
- (b) for a **stand-alone cost prudent discount**—
 - (i) the relevant **customer's connection charges, benefit-based charges** and **residual charge**; less
 - (ii) **settlement residue** paid to the **customer**

Clause 3 **avoided charges**: inserted, on 31 July 2023, by clause 5(3) of the Electricity Industry Participation Code Amendment (Transmission Pricing Methodology Amendments) 2023.

avoided transmission charges [*Revoked*]

Clause 3 **avoided transmission charges**: revoked, on 31 July 2023, by clause 5(1) of the Electricity Industry Participation Code Amendment (Transmission Pricing Methodology Amendments) 2023.

back-dated prudent discount means a **prudent discount** for which the **application**—

- (a) is received by **Transpower** within 6 months of the date on which **Transpower** first publishes the **application requirements** and the **application fee**, if any, for the relevant

type of **prudent discount (inefficient bypass prudent discount or stand-alone cost prudent discount)**; and

- (b) is not rejected by **Transpower** under subclause 14(1), 115(1) or 115(2)

battery storage means equipment functioning together as a single entity that is able to both—

- (a) take **electricity** and store the energy in another form; and
(b) inject that energy as **electricity** into the **grid**, a **local network**, a **non-grid network** or **consuming plant**

BBI customer allocation means a **customer's** allocation of the **benefit-based charge** for a **BBI**—

- (a) specified in or calculated under this **transmission pricing methodology**; and
(b) as adjusted under this **transmission pricing methodology**

BBI prudent discount recovery charge means a charge calculated under subclause 138(1) for a **prudent discount**, **customer** and **pricing year**

BBI reassignment factor has the meaning in subclause 102(4)

beneficiary means, for a **BBI**, a **customer** who has a positive **BBI customer allocation** for the **BBI**

benefit factor has the meaning in subclause 83(7)

benefit-based charge means a charge described in subclause 2(b) and calculated under clause 35 for a **BBI**, **beneficiary** and **pricing year**

benefit-based charge adjustment event has the meaning in subclause 81(1)

benefit-based investment or **BBI** means—

- (a) an **Appendix A BBI**; or
(b) a **post-2019 BBI**

benefitting customer means, for an **application** for an **inefficient bypass prudent discount**, any **customer** named in the **application** whose **transmission charges** would be reduced if the **alternative project** for the **application** were implemented

cap condition means the condition specified in subclause 110(2)

cap recovery charge means a charge described in subclause 2(c) and calculated under clause 112 for a **customer** and **pricing year**

cap recovery-relevant charges means, for a **customer** and **pricing year**, the **customer's**—

- (a) **annual benefit-based charges** for the **Appendix A BBIs** and **pricing year**; and
(b) **annual residual charge** for the **pricing year**,
net of any **prudent discount** of those **transmission charges** for the **customer** and **pricing year**

cap reduction means the total reduction in a **capped customer's transmission charges** for a **pricing year** under subclause 110(1)

capacity means the rated capacity of an asset to (as the case may be)—

- (a) consume or generate **electricity**; or
(b) take **electricity** from or inject **electricity** into a **network**; or
(c) transmit or **distribute electricity**,

in each case measured in units appropriate for the context

capacity measurement period or **CMP** means a period over which a calculation under this **transmission pricing methodology** is made, being either:

CMP A for **pricing year n**, **capacity year n-2**. **CMP A** is relevant to calculating **connection charges**

CMP B for a **BBI**, the period ending on the last **trading period** of the most recent complete **capacity year** before the **final investment decision date** for the **BBI (capacity year n)** and starting on the first **trading period** of **capacity year n-4**. **CMP B** is relevant to calculating **benefit-based charges** for **BBIs** under a **standard method**

CMP C for the first **simple method period**, the period ending on the last **trading period** of the second most recent complete **capacity year** before the **first pricing year (capacity year n)** and starting on the first **trading period** of **capacity year n-4**

for a subsequent **simple method period**, the period ending on the last **trading period** of the second most recent complete **capacity year** before the first **pricing year** of the **simple method period (capacity year n)** and starting on the first **trading period** of **capacity year n-4**.

CMP C is relevant to calculating **benefit-based charges** for **BBIs** under the **simple method**

CMP D the period from the first **trading period** of **financial year 2014** to the last **trading period** of **financial year 2017**. **CMP D** is relevant to calculating **benefit factors** and **residual charges**

CMP E for **pricing year n**, the period from the first **trading period** of **financial year n-8** to the last **trading period** of **financial year n-5**. **CMP E** is relevant to calculating **residual charges**

CMP F for a **SSCGU**, the period ending on the last **trading period** of the most recent complete **capacity year** before the **SSCGU** occurred (**capacity year n**) and starting on the first **trading period** of **capacity year n-4**. **CMP F** is relevant to adjusting **benefit-based charges** for **high-value BBIs**

CMP G the period from the first **trading period** of **pricing year 2015** to the last **trading period** of **pricing year 2019**. **CMP G** is relevant to calculating **difference caps**

capacity year means a period of 12 months starting on 1 September and ending on 31 August.

Capacity year n means the **capacity year** starting in year n

capital charge means **Transpower's** return on its investment in an asset

capped charges means, for a **capped customer** and **pricing year**, the **capped customer's**:

- (a) **annual benefit-based charges** for the **Appendix A BBIs** and **pricing year**; and
- (b) **annual residual charge** for the **pricing year**
- (c) *[Revoked]*

Clause 3 **capped charges** paragraph (b): amended, on 31 July 2023, by clause 5(2)(a) of the Electricity Industry Participation Code Amendment (Transmission Pricing Methodology Amendments) 2023.

Clause 3 **capped charges** paragraph (c): revoked, on 31 July 2023, by clause 5(2)(b) of the Electricity Industry Participation Code Amendment (Transmission Pricing Methodology Amendments) 2023.

capped customer means—

- (a) for the **first pricing year**, a **customer**, other than in its capacity as a **generator**, who was a **customer** during **pricing year 2019** and at least 2 **pricing years** preceding **pricing year 2019**; and
- (b) for each subsequent **pricing year**, any such **customer** who had a **cap reduction** for the previous **pricing year**

closing RAB value has the meaning in the **Transpower IMs**

coincident peak offtake has the meaning in subclause 65(8)

Commission means the Commerce Commission established by section 8 of the Commerce Act 1986

commissioned has the meaning in clause 5

commissioning date means the date an asset, **connection investment** or **interconnection investment** (including a **BBI**) is **commissioned**

compliance investment means an investment by **Transpower** in an existing **grid asset** or **transmission alternative** to ensure the **grid asset** or **transmission alternative** is maintained, and can be operated, in accordance with **good electricity industry practice**. A **compliance investment** may also be an **enhancement investment**, **refurbishment investment** or **replacement investment**

connection asset has the meaning in subclause 21(1), and includes “deep” **connection assets** as described in paragraph 22(5)(b)

connection charge means a charge described in subclause 2(a) and calculated under clause 24 for a **customer** and **pricing year** and—

- (a) a **connection asset** and **connection location**; or
- (b) a **connection transmission alternative**

connection charge adjustment event has the meaning in clause 76

connection customer allocation means a **customer’s** allocation of the **connection charge** for a **connection asset** and **connection location** calculated under clause 32

connection investment means a **transmission investment** or group of related **transmission investments** exclusively in 1 or more **connection assets** or **connection transmission alternatives**

connection link has the meaning in paragraph 20(1)(e)

connection node has the meaning in paragraph 20(1)(d)

connection region means a region determined by **Transpower** under subclause 62(4)

connection transmission alternative means a **transmission alternative** to the extent it is an alternative to an investment in a **connection asset**, as determined by **Transpower**

consuming plant means—

- (a) equipment that consumes **electricity**, regardless of size, including electrical appliances as defined in the Electricity Act 1992; and
- (b) **battery storage** when charging

continuing BBI has the meaning in subclause 84(5) or 85(4)

contributing customer means, for a **funded asset**—

- (a) a **customer** who funded, or is funding, all or part of the capital cost of the **funded asset** under an **investment agreement**; or
- (b) a **customer** who funded, or is funding, all or part of the capital cost of the **funded asset** through **connection charges**

counterfactual means, for a **BBI**, the expected future **grid** state assuming the **BBI** is not **commissioned**

covered cost means the amount of **recoverable revenue** allocated to a **BBI** for a **pricing year** calculated under subclause 39(1)

CPI means the consumers price index (all groups) published by Stats NZ

curtailed energy means **unserved energy** or **unsupplied energy**

customer means a **designated transmission customer**

demand factor means the scaling factor for **regional NPB** for **regional demand groups** under the **simple method** calculated under clause 64(4)

depreciation means depreciation of an asset calculated in accordance with the **Transpower IMs**

de-rate means, for an asset or **plant**, to alter the asset or **plant** physically so that the asset's or **plant's capacity** is permanently reduced

difference cap has the meaning in clause 111(1)

direct supplied load customer means, for a **connection location** and **trading period**, a **connected asset owner** who—

- (a) owns or controls a **local network** or **consuming plant** connected to the **grid** at the **connection location**; and
- (b) has **embedded electricity** at the **connection location** of the type defined in paragraph 4(1)(b) for the **trading period**

discounted BBI means—

- (a) for an **inefficient bypass prudent discount**, a **BBI** that would be bypassed by the relevant **alternative project**; or
- (b) for a **stand-alone cost prudent discount**, a **BBI** of which the **prudent discount recipient** is a **beneficiary**

economic life means, for an asset, the asset's physical asset life as defined in the **Transpower IMs**

EDB ID determination means the *Electricity Distribution Information Disclosure Determination 2012* [2012] NZCC 22

EDB IMs means the *Electricity Distribution Services Input Methodologies Determination 2012* [2012] NZCC 26

efficient stand-alone investment has the meaning in clause 135

eligible BBI means a **BBI**, including a **BBI** that is currently **reassigned** or was previously **reassigned**, for which both of the following conditions are satisfied (as applicable):

- (a) the total **closing RAB value** of all assets comprised in the **BBI** for the most recent complete **financial year**, adjusted by the **BBI reassignment factor** for any current **reassignment** the **BBI** is subject to, is at least the **reassignment threshold**;
- (b) if the **BBI** is a **post-2019 BBI**, either—
 - (i) at least 10 years have passed since the **BBI's commissioning date**; or
 - (ii) since the **BBI's commissioning date**—
 - (A) a **customer** permanently disconnected from the **grid** at a **connection location** at which the **customer** was a **beneficiary** of the **BBI** when it disconnected; and
 - (B) that disconnection, by itself and without taking into account other events, caused the **BBI's BBI reassignment factor** to decrease by at least 0.2; or
 - (iii) since the **BBI's commissioning date**—
 - (A) a **customer** who is a **beneficiary** of the **BBI** permanently disconnected **plant** from the **grid**; and
 - (B) that disconnection, by itself and without taking into account other events, caused the **BBI's BBI reassignment factor** to decrease by at least 0.2

eligible person means, for an **application** for **reassignment** or a proposal to reverse a **reassignment**—

- (a) a **beneficiary** of the **BBI** to which the **application** or proposal relates; or
- (b) a person who owns or controls **embedded plant** connected to the **local network** or **grid-connected plant** of a **beneficiary** of the **BBI**

embedded means, for **plant**, that the **plant** is connected to a **local network** or to **grid-connected plant**. If the **plant** is also connected to the **grid**, **Transpower** may treat the **plant** as part **embedded** and part **grid-connected**

embedded electricity has the meaning in paragraph 4(1)(b), 4(1)(c) or 4(1)(d) for a **customer** and **trading period**

enhancement investment means a **transmission investment** that is not a **refurbishment investment** or **replacement investment**. An **enhancement investment** may also be a **compliance investment**

event pricing year means the **pricing year** during which an **adjustment event** occurs

exacerbated price means, for a **regional customer group**, **factual** and **counterfactual**, a price at a **market node** in the **regional customer group's modelled region** that, due to a **modelled constraint** is—

- (a) higher in the **factual** than the **counterfactual**; or
- (b) lower in the **counterfactual** than a price at another **market node** in the **counterfactual** that is in a **modelled region** for a different **regional customer group** of the same type (**regional demand group** or **regional supply group**)

exempt post-2019 investment means an **interconnection investment**, other than the **post-2019 CUWLP investment**, that is—

- (a) **commissioned** after 23 July 2019 and before the start of **financial year 2021**; and
- (b) a **refurbishment investment**, **replacement investment** or **enhancement investment** in respect of an **Appendix A BBI** or another **interconnection investment commissioned** on or before 23 July 2019

exempt pricing year means, for an **adjustment event** and **customer**—

- (a) the **event pricing year**; and
- (b) the **pricing year** after the **event pricing year** if the **adjustment event** occurred less than 1 month before the deadline for **Transpower** notifying the **customer** of its **transmission charges** for the **pricing year** under the relevant **transmission agreement**

expected effective full commissioning date means, for a **BBI**, a date determined by **Transpower**, which must fall within the period from (and including) the **BBI's** expected **commissioning date** to (and including) the **BBI's** expected **full commissioning date**, by which sufficient **grid assets** and **transmission alternatives** comprised in the **BBI** are expected to have been **commissioned** such that all of the **BBI's** principal benefits will have been released

factual means, for a **BBI**, the expected future **grid** state assuming the **BBI** is **fully commissioned**

final investment decision date means, for a **BBI**, the date **Transpower** makes its final decision to proceed with its investment in the **BBI**

financial year means a period of 12 months starting on 1 July and ending on 30 June.

Financial year n means the **financial year** starting in year n

first pricing year means the first **pricing year** to which this **transmission pricing methodology** applies

forecast loading period has the meaning in subclause 102(1)

forecast peak loading has the meaning in subclause 102(2)

full commissioning date means the date a **connection investment** or **interconnection investment** (including a **BBI**) is **fully commissioned**

fully commissioned has the meaning in clause 5

funded asset means a **connection asset**—

- (a) **commissioned** after the start of the **first pricing year**; and
- (b) (all or part of the capital cost of which was funded, or is being funded, by a **customer** under an **investment agreement**

future regional customer group means a **regional customer group**—

- (a) that is expected to have no members when the relevant **post-2019 BBI** is **commissioned**; and
- (b) the future members of which (if any) will be new **customers** and **customers** who connect new **plant** to the **grid**

GAAP means generally accepted accounting practice in New Zealand

GEIP (standing for good electricity industry practice) means, for an **alternative project**, the exercise of that degree of skill, diligence, prudence, foresight and economic management that would reasonably be expected from a skilled and experienced asset owner engaged in the management of the **alternative project**, under conditions comparable to those applicable to the **alternative project**, consistent with applicable law, safety and environmental protection

generating plant has the meaning in Part 1 of this Code and includes **battery storage** when discharging

grid assets has the meaning in subclause 17(1)

grid point of connection means a **point of connection** to the **grid**

gross energy has the meaning in subclause 4(5)

GXP tie means a situation in which a **connected asset owner's assets** are simultaneously connected to the **grid** at more than 1 **point of connection**

high-value means, for a **BBI**, that the sum of—

- (a) the depreciated value of the assets comprised in the **BBI**; and
- (b) expected future **TA opex** for the **interconnection transmission alternatives** comprised in the **BBI**,

is, at the relevant time, more than the base capex threshold as defined in the **Transpower Capex IM**

high-value intervening BBI means a **post-2019 BBI**—

- (a) with a **final investment decision date** before the start of the **first pricing year**; and
- (b) **commissioned** on or before the last day of the **financial year** that precedes the **pricing year** after the **first pricing year**; and
- (c) expected to be **high-value** when **fully commissioned**

high-voltage grid means the part of the **grid** with a nominal voltage of 220 kV or more

HILP event means a low probability event or group of events that, if it or they occurred, would have a high impact on **unserved energy** other than by way of cascade failure, as determined by **Transpower**

host customer means, for **embedded plant**, the **customer** who owns or controls the **local network** or **grid-connected plant** the **embedded plant** is connected to

HVDC asset means a **grid asset** that is part of the **HVDC link**

HVDC opex means—

- (a) **availability costs** allocated to the **HVDC owner**; and
- (b) insurance premiums for the **HVDC link**

ID WACC means, for **Transpower** or a **distributor**, the post-tax or pre-tax (as the context requires) **WACC** determined by the **Commission** under the **Transpower IMs** or **EDB IMs** for the purposes of **Transpower's** or the **distributor's** information disclosure regulation under Part 4 of the Commerce Act 1986

independent expert means an independent person who is a recognised technical expert in the matter that has been referred to him or her. In appointing an **independent expert**, the party referring the matter to the **independent expert** must nominate 3 persons and the other party may agree that any 1 of them be appointed. Failing agreement between the parties, the **independent expert** will be appointed by the **Authority**

independent verification means, for an **application**, a written report on the accuracy and sufficiency of the information and analysis contained in the **application** prepared by 1 or more persons who are—

- (a) recognised technical experts on the subject matter of the **application**; and
- (b) independent of the **customer** making the **application**; and
- (c) approved by **Transpower**

indirect supplied load customer means, for a **connection location** and **trading period**, an **asset owner** who—

- (a) owns or controls a **local network**, **consuming plant** or **generating plant** connected to the **grid** at the **connection location**; and
- (b) has **embedded electricity** at the **connection location** of the type defined in paragraph 4(1)(c) for the **trading period**

individual NPB means **NPB** for a **customer** calculated under clause 47 or 57 or subclause 61(1)

inefficient bypass prudent discount means a discount of a **customer's transmission charges** provided under this **transmission pricing methodology** for the purpose in clause 127

injection means—

- (a) for a **trading period** and a **customer's grid point of connection**, the positive net quantity of **electricity** flow into the **grid** at the **grid point of injection** from the **customer's assets** during the **trading period** (if any); and
- (b) for a **trading period** and a **customer's connection location**, the positive net quantity of **electricity** flow into the **grid** at all of the **customer's grid points of connection** at the **connection location** during the **trading period** (if any)

injection customer means, for a **connection location** and **trading period**, a **customer** at the **connection location** who has **injection** at the **connection location** for the **trading period**

interconnection asset has the meaning in subclause 21(2)

interconnection investment means a **transmission investment** or group of related **transmission investments** exclusively in 1 or more **interconnection assets** or **interconnection transmission alternatives**

interconnection link has the meaning in paragraph 20(1)(f)

interconnection node has the meaning in paragraph 20(1)(a)

interconnection transmission alternative means a **transmission alternative** to the extent it is not a **connection transmission alternative**

intra-regional allocator has the meaning in subclause 65(1), 65(2), 65(3) or 65(4) for the relevant **regional customer group**

investment agreement means—

- (a) a contract entered into at any time between **Transpower** and another person (who may or may not be a **customer**) under which—
 - (i) **Transpower** agrees to provide any new, **upgraded** or modified **transmission investment**; or
 - (ii) the other person agrees to make a contribution to the capital, maintenance, operating or other cost of a **transmission investment**, including—
 - (iii) a **new investment agreement contract**; and
 - (iv) a contract to move or remove **grid assets**; or
- (b) an agreement deemed to be an **investment agreement** under paragraph 28(5)(b)

investment agreement asset means a **grid asset** provided under an **investment agreement**

investment grid means a simplified model of the **grid** for a **market BBI's factual** or **counterfactual** that models—

- (a) all existing **branches** and **market nodes**, as those **branches** and **market nodes** may be added to or removed in the **market BBI's factual** or **counterfactual** (as the case may be); and
- (b) the **constraints** of the **HVDC link**, as those **constraints** would be in the **market BBI's factual** or **counterfactual** (as the case may be); and
- (c) the **market BBI's modelled constraints**, as those **constraints** would be in the **market BBI's factual** or **counterfactual** (as the case may be)

investment reassignment factor has the meaning in subclause 102(3)

investment region means a **modelled region** under the **simple method** where a **BBI** or part of a **BBI** is located

investment test means the investment test applied to a **tested investment** under section III of Part F of the **rules** or the **Transpower Capex IM**

land and buildings has the meaning in subclause 17(3)

large means, subject to clause 7—

- (a) for **plant**, that the **plant**—
 - (i) is connected to the **grid**; or
 - (ii) has **capacity** of at least 10 MW; and
- (b) for an **upgrade** of **plant**, that the **plant's capacity** has increased by at least 10 MW compared to the **plant's capacity** before the **upgrade**; and
- (c) for a **de-rating** of **plant**, that the **plant's capacity** has reduced by at least 10 MW compared to the **plant's capacity** before the **de-rating**

link has the meaning in subclause 19(3)

load customer means a **customer** who, at a **connection location** during a **trading period**, is or was (as the context requires) 1 or more of the following:

- (a) an **offtake customer**;
- (b) a **direct supplied load customer**;
- (c) an **indirect supplied load customer**;
- (d) a **supplying load customer**

loop has the meaning in paragraph 20(1)(b)

low-value means, for a **BBI**, that the sum of—

- (a) the depreciated value of the assets comprised in the **BBI**; and
- (b) expected future **TA opex** for the **interconnection transmission alternatives** comprised in the **BBI**,

is, at the relevant time, not more than the base capex threshold as defined in the **Transpower Capex IM**

low-voltage grid means the part of the **grid** with a nominal voltage of less than 220 kV

market BBI means a **post-2019 BBI** that is expected to have a material impact on prices or quantities in the **wholesale market** for **electricity** relative to the **post-2019 BBI's counterfactual**. A **market BBI** may also be an **ancillary service BBI** or a **reliability BBI**, but cannot be a **resiliency BBI**

market node means a **GXP** or **GIP**

market regional NPB means **regional NPB** arising from changes in prices or quantities in the **wholesale market** for **electricity**. **Market regional NPB** is calculated for **market BBIs**

market scenario means, for a **BBI**, a future state for factors that influence **NPB** for the **BBI**

material damage means destruction of, or substantial damage to, a **BBI**, as determined by **Transpower**

maximum gross demand has the meaning in subclause 4(6)

maximum revenue means, for a **pricing year**, the maximum revenue **Transpower** is permitted to recover for the **pricing year**, as determined by the **Commission** under Part 4 of the Commerce Act 1986. At the date of this **transmission pricing methodology**, this is the most recently updated forecast SMAR for the **pricing year** under the **Transpower IPP**

MCP opex means operating costs of the type described in clause 3.1.3(1)(d) of the **Transpower IMs**, being operating costs relating to major capex projects

mixed connection asset means a **connection asset** that, as well as connecting a **customer**, is used for **grid** operation generally

modelled constraint means, for a **market BBI**—

- (a) a **constraint** affecting a new **grid asset** comprised in the **market BBI**; or
- (b) a **constraint** that would be alleviated materially if the **market BBI** were **fully commissioned**, as determined by **Transpower**

modelled region means a region defined in, or determined by **Transpower** under—

- (a) for a **BBI** under the **price-quantity method**, subclause 50(1), 54(3), 55(4) or 56(3) depending on the type of **regional NPB** being calculated; and
- (b) for a **BBI** under the **resiliency method**, clause 58; and
- (c) for a **BBI** under the **simple method**, subclause 62(1)

monthly benefit-based charge has the meaning in subclause 35(3)

monthly cap recovery charge has the meaning in subclause 112(2)

monthly charges means the following **transmission charges** for a **customer** and **pricing year**:

- (a) **monthly connection charges**;
- (b) **monthly benefit-based charges**;
- (c) **monthly cap recovery charge**;
- (d) **monthly prudent discount recovery charge**;
- (e) **monthly residual charge**

monthly connection charge has the meaning in subclause 24(4)

monthly prudent discount recovery charge has the meaning in subclause 138(6)

monthly residual charge has the meaning in subclause 68(3)

net private benefit or **NPB** (which may be negative, zero or positive)—

- (a) means, for a **regional customer group** or **customer**, the sum of the quantified benefits (positive values) and disbenefits (negative values) the **regional customer group** or **customer** is expected to receive from the relevant **BBI**; and
- (b) for a **host customer**, includes the sum of the quantified benefits (positive values) and disbenefits (negative values) the **embedded plant** owners connected to the **host customer's local network** or **grid-connected plant** are expected to receive from the relevant **BBI**

node has the meaning in subclause 19(1)

nominated peak kVar means, for a **connected asset owner**, **zone** and **capacity year**, the quantity $\sum_j Q_{xjz}$ in subclause 8.67(2) of this Code calculated using the **connected asset owner's** nomination for the **zone** applying from the most recent 1 March before the start of the **capacity year**

non-contributing customer means, for a **funded asset**, a **customer** who—

- (a) is connected by the **funded asset** at a **connection location**; and
- (b) was not a **contributing customer** for the **funded asset** before connecting to it

non-grid network means a system of **lines**, substations and other **works**, used primarily for the conveyance of **electricity**, that is not part of the **grid** or connected to the **grid**, including an **embedded network**

notional IRA value has the meaning in clause 67

offtake means—

- (a) for a **trading period** and a **customer's grid point of connection**, the positive net quantity of **electricity** flow out of the **grid** at the **grid point of connection** into the **customer's assets** during the **trading period** (if any); and

- (b) for a **trading period** and a **customer's connection location**, the positive net quantity of electricity flow out of the grid at all of the **customer's grid points of connection** at the **connection location** during the **trading period** (if any)

offtake customer means, for a **connection location** and **trading period**, a **customer** at the **connection location** who has **offtake** at the **connection location** for the **trading period**

opening RAB value has the meaning in the **Transpower IMs**

optimised replacement cost means, for any **grid asset** or group of **grid assets**, the optimised replacement cost of the **grid asset** or group of **grid assets** as at 1 July 2006, as determined by **Transpower**

other regional NPB means **regional NPB** that is not **market regional NPB**, **ancillary service regional NPB** or **reliability regional NPB**. **Other regional NPB** may be calculated for **market BBIs**, **ancillary service BBIs** or **reliability BBIs**

outage scenario means, for a **reliability BBI**, an **outage** or other event or group of events affecting access to **transmission services** in respect of which the **reliability BBI** is expected to have a material impact on **curtailed energy**

peak BBI means a **post-2019 BBI** for which the investment need is primarily attributable to meeting peak **demand**

peak offtake trading period has the meaning in paragraph 65(8)

periods of benefit has the meaning in paragraph 51(3)(b)

plant means **consuming plant** or **generating plant**

post-2019 BBI means an **interconnection investment commissioned** after 23 July 2019 excluding any **exempt post-2019 investment**. To avoid doubt—

- (a) the **post-2019 CUWLP investment** is a **post-2019 BBI**; and
- (b) an **interconnection investment** that is an **Appendix A BBI** is not a **post-2019 BBI**; and
- (c) an **interconnection investment** carried out or approved as a single project or programme may comprise more than 1 **post-2019 BBI**; and
- (d) a **post-2019 BBI** may comprise more than 1 **interconnection investment**, each of which is carried out or approved as a single project or programme

post-2019 CUWLP investment means the **interconnection investment** comprising the following **transmission investments** approved by the Electricity Commission on 9 August 2010 as part of the Lower South Island Renewables Investment:

- (a) thermal upgrade of the circuits between Cromwell and Twizel;
- (b) re-conductoring of the circuits between Roxburgh and Livingstone

PQ WACC means, for **Transpower** or a price-quality regulated **distributor**, the vanilla or pre-tax (as the context requires) **WACC** determined by the **Commission** under the **Transpower IMs** or **EDB IMs** for the purposes of **Transpower's** or the **distributor's** price-quality regulation under Part 4 of the Commerce Act 1986

pre-commencement adjustment event means an event that occurred before the start of the **first pricing year** and—

- (a) would have been an **adjustment event** had it occurred at or after the start of the **first pricing year**; or
- (b) **Transpower** determines is analogous to an **adjustment event**

pre-existing customer means a **customer** who has been a member of a **regional customer group** for (as the case may be)—

- (a) at least 2 full **capacity years** during **CMP B** for the relevant **BBI**; or
- (b) at least 2 full **capacity years** during **CMP C** for the relevant **simple method period**

pre-existing load customer means a **load customer** who was a **customer** for the whole of **CMP D**

pre-start adjustment event means, for a **post-2019 BBI**, an event that occurred before the start of the **post-2019 BBI's start pricing year** and would have been a **benefit-based charge adjustment event** for the **post-2019 BBI** had it occurred at or after the start of the **post-2019 BBI's start pricing year**. To avoid doubt, a **pre-start adjustment event** may be a **pre-commencement adjustment event**

previous discount means—

- (a) a prudent discount provided under the **previous transmission pricing methodology**; or
- (b) a discount provided under a **notional embedding contract**; or
- (c) any other discount or effective discount of transmission charges provided under an agreement between **Transpower** and a **customer** entered into before the start of the **first pricing year**

previous transmission pricing methodology means, as applicable, the transmission pricing methodology comprised in this Code when it came into force, as subsequently amended up to the date this **transmission pricing methodology** came into force

price-quantity method means the method for calculating **NPB** for a **post-2019 BBI** specified in clauses 44 to 55

pricing year has the meaning given to that term in the **Transpower IMs**. At the date of this **transmission pricing methodology**, a **pricing year** is a period of 12 months starting on 1 April and ending on 31 March. **Pricing year n** means the **pricing year** starting in year n

prior contributing customer means, for a **funded asset** and in respect of a **non-contributing customer** for the **funded asset**, a **contributing customer** who was connected to the **funded asset** before the **non-contributing customer** became connected to the **funded asset**

prudent discount means an **inefficient bypass prudent discount** or **stand-alone cost prudent discount**. The amount of a **prudent discount** for a **pricing year** is—

- (a) the absolute value of the reduction in the **prudent discount recipient's transmission charges** for the **pricing year** under the **prudent discount** agreement; less
- (b) the annuity payable by the **prudent discount recipient** under the **prudent discount** agreement

prudent discount calculation period means, for a **prudent discount**, the period—

- (a) starting at the start of the **prudent discount's start pricing year**, or estimated **start pricing year** assuming the **prudent discount** is approved; and
- (b) ending—
 - (i) for an **inefficient bypass prudent discount**, at the end of the remaining **economic life** of the **grid assets** the relevant **alternative project** would bypass, up to a maximum of 15 years after the start of the **prudent discount calculation period**; or
 - (ii) for a **stand-alone cost prudent discount**, 15 years after the start of the **prudent discount calculation period**

prudent discount confirmation date means, for a **prudent discount** decision, the date the following conditions are satisfied:

- (a) either—
 - (i) the relevant **customer** has confirmed to **Transpower** in writing that it does not intend to refer any aspect of **Transpower's** decision to an **independent expert**; or

- (ii) the **customer** did not refer any aspect of **Transpower's** decision to an **independent expert** before time to do so expired under subclause 120(3); or
 - (iii) an **independent expert** has made final binding decisions on all aspects of **Transpower's** decision referred to the **independent expert**:
- (b) for an approved **prudent discount**, **Transpower** and the **customer** have entered into a **prudent discount** agreement for the **prudent discount**

prudent discount practice manual means a document **published** by **Transpower** containing assumptions and detailed methodologies that **Transpower**—

- (a) intends to apply for assessing **applications** for **prudent discounts**; and
- (b) does not expect to vary between **prudent discount applications** except according to whether the **application** is for an **inefficient bypass prudent discount** or **stand-alone cost prudent discount**

prudent discount rate means—

- (a) subject to paragraph 128(c), for an **inefficient bypass prudent discount**—
 - (i) if the applicant **customer** is a **distributor**, the **distributor's ID WACC** at the time of the **application** for the **prudent discount**; or
 - (ii) if the applicant **customer** is not a **distributor** but is subject to another regulated **WACC**, that **WACC**; or
 - (iii) otherwise, a **WACC** for the applicant **customer** determined by **Transpower** by applying the methodology for estimating **ID WACC** for **distributors** in the **EDB IMs**; or
- (b) for a **stand-alone cost prudent discount**, **Transpower's ID WACC** at the time of the **application** for the **prudent discount**

prudent discount recipient means a **customer** receiving a **prudent discount**

prudent discount recovery charge means a charge described in subclause 2(d), being a **BBI prudent discount recovery charge** or **residual prudent discount recovery charge**

reassignment means a reassignment of all or part of the **covered cost** of a **BBI** to **residual revenue**, and **reassigned** has a corresponding meaning

reassignment amount has the meaning in clause 97

reassignment confirmation date means, for a **reassignment** decision, the date any of the following conditions is satisfied:

- (a) the relevant **eligible person** has confirmed to **Transpower** in writing that it does not intend to refer any aspect of **Transpower's** decision to an **independent expert**:
- (b) **expert** the **eligible person** did not refer any aspect of **Transpower's** decision to an **independent** before time to do so expired under subclause 104(3) or paragraph 107(2)(c):
- (c) an **independent expert** has made final binding decisions on all aspects of **Transpower's** decision referred to the **independent expert**

reassignment practice manual means a document **published** by **Transpower** containing assumptions and detailed methodologies that **Transpower**—

- (a) intends to apply for assessing **applications** for **reassignment**; and
- (b) does not expect to vary between **reassignment applications**

reassignment threshold has the meaning in subclause 98(2)

recent customer means a **customer** who has been a member of a **regional customer group** for (as the case may be)—

- (a) less than 2 full **capacity years** during **CMP B** for the relevant **BBI**; or
- (b) less than 2 full **capacity years** during **CMP C** for the relevant **simple method period**

recent load customer means a **load customer** who is not a **pre-existing load customer**

recoverable revenue means, for a **pricing year**—

- (a) **maximum revenue** for the **pricing year**; less
- (b) any part of **maximum revenue** for the **pricing year** **Transpower** is able or required to recover other than through **transmission charges**, including by way of annuities paid by **prudent discount recipients**

reduction event means, for a **pre-existing load customer**, a reduction in the **pre-existing load customer's** expected **maximum gross demand** compared to the **pre-existing load customer's** **AMDR** baseline calculated under clause 70(1)—

- (a) of at least 10 **MW**; and
- (b) due to an event or series of directly related events that—
 - (i) occurred, or **Transpower** determines will occur, after the start of **CMP D** and before the start of the **first pricing year**; and
 - (ii) **Transpower** determines was, were or will be beyond the **pre-existing load customer's** reasonable control, not being—
 - (A) a change in the basis for calculating future transmission charges; or
 - (B) a change in the market for the **pre-existing load customer's** products or services, other than the services the **pre-existing load customer** supplies to an **embedded plant** owner connected to the **pre-existing load customer's** **local network** or **grid-connected plant** who is not a **related entity** of the **pre-existing load customer**; or
 - (C) any of the events specified in paragraph (d) of the definition of **force majeure event** in clause 1.1(1) of this Code occurring in respect of the **pre-existing load customer** or a **related entity** of the **pre-existing load customer**; or
 - (D) 1 or more events that could have been prevented by the **customer** by the exercise of a reasonable standard of care; and
- (c) that **Transpower** determines is reasonably likely to persist for at least 5 years after the event or series of directly related events occurred or will occur

refurbishment investment means a **transmission investment** that—

- (a) is asset refurbishment as defined in the **Transpower Capex IM**; or
- (b) would be asset refurbishment as defined in the **Transpower Capex IM** if an investment in a **transmission alternative** were an investment in the **grid**.

A **refurbishment investment** may also be a **compliance investment**

regional customer group means a **regional demand group** or **regional supply group**

regional demand group means a group of **customers** in a **modelled region** defined in, or determined by **Transpower** under—

- (a) for a **BBI** under the **price-quantity method**, subclause 50(2), 53(3), 55(4) or 55(3) depending on the type of **regional NPB** being calculated; and
- (b) for a **BBI** under the **resiliency method**, clause 58; and
- (c) for a **BBI** under the **simple method**, clause 63

regional NPB means **NPB** for a **regional customer group** calculated in accordance with, or assumed under, a **standard method** or the **simple method**

regional supply group means a group of **customers** in a **modelled region** defined in, or determined by **Transpower** under —

- (a) for a **BBI** under the **price-quantity method**, subclause 50(2), 54(3), 55(4) or 56(3) depending on the type of **regional NPB** being calculated; and
- (b) for a **BBI** under the **simple method**, clause 63

regulatory asset base or **RAB** means **Transpower's** record of **commissioned** assets and their depreciated values used to calculate **maximum revenue** under the **Transpower IMs**

regulatory control period or **RCP** means a regulatory period as defined in the **Transpower IPP**

related entity of a person means another person that controls, is controlled by, or is under common control with the first person, including a person that—

- (a) is a related company of the first person as defined in section 2(3) of the Companies Act 1993; or
- (b) would be a related company of the first person under that section if both the first person and the other person were companies registered under that Act

reliability BBI means a **post-2019 BBI** that is expected to reduce materially **curtailed energy** relative to the **post-2019 BBI's counterfactual** if there is an **outage** or other event or group of events affecting access to **transmission services**. A **reliability BBI** may also be a **market BBI** or **ancillary service BBI**, but cannot be a **resiliency BBI**

reliability regional NPB means **regional NPB** arising from changes in **curtailed energy**. **Reliability regional NPB** is calculated for **reliability BBIs**

replacement cost means, for a **grid asset** and subject to subclause 34(5), the cost of replacing the **grid asset**, either separately or as part of a group of **grid assets**, with a modern equivalent **grid asset** with the same service potential

replacement cost adjustment factor means, for a **grid asset** or group of **grid assets**, the **optimised replacement cost** for the **grid asset** or group of **grid assets** divided by the cost, as at (or about) 1 July 2006, of replacing the **grid asset** or group of **grid assets** with the then modern equivalent **grid asset** with the same service potential, as determined by **Transpower**

replacement investment means a **transmission investment** that—

- (a) is asset replacement as defined in the **Transpower Capex IM**; or
- (b) would be asset replacement as defined in the **Transpower Capex IM** if an investment in a **transmission alternative** were an investment in the **grid**.

A **replacement investment** may also be a **compliance investment**

residual charge means a charge described in subclause 2(e) and calculated under clause 68 for a **load customer** and **pricing year**

residual charge adjustment event has the meaning in subclause 92(1)

residual charge adjustment factor or **RCAF** means the factor calculated under clause 71 for a **load customer** and **pricing year**

residual prudent discount recovery charge means a charge calculated under subclause 138(3) for a **prudent discount**, **customer** and **pricing year**

residual revenue means, for a **pricing year**, **recoverable revenue** for the **pricing year** less all **transmission charges** for the **pricing year** other than **residual charges**. The minimum value of **residual revenue** for a **pricing year** is 0

resiliency BBI means a **post-2019 BBI** for which the investment need is primarily attributable to mitigating a risk of cascade failure or a **HILP event**. A **resiliency BBI** cannot also be a **market BBI**, **ancillary service BBI** or **reliability BBI**

resiliency method means the method for calculating **NPB** for a **resiliency BBI** specified in clauses 56 to 58

reverse flow means **electricity** exiting the **grid** at a **GXP** and entering the **grid** at another **GXP** as a result of a **GXP tie**

scenario means a **market scenario** or **outage scenario**

Schedule 1 allocation means, for a **Schedule 1 customer** and **Appendix A BBI**, the **Schedule 1 customer's** allocation for the **Appendix A BBI** specified in Schedule 1 of the **2020 guidelines** to 2 decimal places

Schedule 1 beneficiary means, for an **Appendix A BBI**, a **Schedule 1 customer** who has a positive **Schedule 1 allocation** for the **Appendix A BBI**

Schedule 1 customer means a person specified in Schedule 1 of the **2020 guidelines**, even if not a current **customer** at the time this definition is applied

simple method means the method for calculating **NPB** for a **low-value post-2019 BBI** specified in clauses 59 to 64

simple method BBC cap has the meaning in subclause 83(5B)

Clause 3 **simple method BBC cap**: inserted, on 10 April 2024, by clause 4 of the Electricity Industry Participation Code Amendment (Benefit-based Charge Adjustment Event: New Customer) 2024.

simple method contribution has the meaning in clause 64(7)

simple method factor has the meaning in subclause 61(2)

simple method period has the meaning in clause 60

small regional loop has the meaning in paragraph 20(1)(c)

specified ancillary service means **instantaneous reserve, frequency keeping or voltage support**

specified pre-start adjustment event means, for a **post-2019 BBI** and **pre-existing customer**, a **pre-start adjustment event** for the **post-2019 BBI** that would have been a **benefit-based charge adjustment event** in any of paragraphs 81(1)(d) to 81(1)(h) in respect of the **pre-existing customer**

stand-alone cost prudent discount means a discount of a **customer's transmission charges** provided under this **transmission pricing methodology** for the purpose in clause 133

standard method means the **price-quantity method** or **resiliency method**

standard method calculation period means, for a **BBI**, the period—

- (a) starting on the first 1 January after the **BBI's expected effective full commissioning date**; and
- (b) ending on the earlier of—
 - (i) 20 years after that 1 January; and
 - (ii) the end of the useful life of the **BBI**, as determined by **Transpower**

standard method rate means, for a **BBI**—

- (a) if the **BBI** is a **tested investment**, the pre-tax, real discount rate used when the **BBI** was assessed under the **investment test**, excluding discount rates used only for sensitivity analysis; or
- (b) otherwise—
 - (i) the applicable rate **published** in the **assumptions book**; or
 - (ii) if there is no applicable rate **published** in the **assumptions book**, the rate in clause D6(3)(a) of the **Transpower Capex IM**

start pricing year means—

- (a) for a **connection investment**, the first **pricing year** that starts after the end of the **financial year** during which the **connection investment** was **commissioned**; or
- (b) for a **BBI**, the first **pricing year** that starts after the end of the **financial year** during which the **BBI** was **commissioned** (which, for an **Appendix A BBI**, is the **first pricing year**); or
- (c) for a **SSCGU**, the first **pricing year** that starts at least 6 months (or such shorter period as **Transpower** may determine is practicable) after the date of the **SSCGU**; or
- (d) for a **reassignment**, the first **pricing year** that starts at least 6 months (or such shorter period as **Transpower** may determine is practicable) after the **reassignment confirmation date**; or
- (e) for an **inefficient bypass prudent discount** and subject to paragraph 122(2), the first **pricing year** that starts—
 - (i) at least 6 months (or such shorter period as **Transpower** may determine is practicable) after the **prudent discount confirmation date**; and
 - (ii) on or after a date determined by **Transpower** based on the time that would be required for the **prudent discount recipient** to implement the relevant **alternative project** if the project to implement the **alternative project** had started on the date **Transpower** received the **application** for the **inefficient bypass prudent discount**; or
- (f) for a **stand-alone cost prudent discount** and subject to paragraph 122(2), the first **pricing year** that starts at least 6 months (or such shorter period as **Transpower** may determine is practicable) after the **prudent discount confirmation date**

station means a substation or switching station

substantial sustained increase means, for **large plant**, an increase in the **large plant's** expected annual **electricity** consumption or generation (as the case may be)—

- (a) of at least 25% since the last time the relevant **customer's BBI customer allocations** for 1 or more **BBIs** were calculated, as assessed under subclause 81(4); and
- (b) that is not attributable to a **large upgrade** of the **large plant**; and
- (c) that **Transpower** determines is reasonably likely to persist for at least 5 years after the start of the relevant **event pricing year**

substantial sustained change in grid use or **SSCGU** means an event or series of directly related events that result in a change in expected total annual **injection** or **offtake**—

- (a) of at least 5% of average total annual **injection** or **offtake** (as the case may be) over **CMP F**; and
- (b) that **Transpower** determines is reasonably likely to persist for at least 5 years after the event or series of directly related events occurred

supplying load customer means, for a **connection location** and **trading period**, a **generator** who—

- (a) owns or controls **generating plant** connected to the **grid** at the **connection location**; and
- (b) has **embedded electricity** at the **connection location** of the type defined in paragraph 4(1)(d) for the **trading period**

system limit means a level of **supply**, **demand** or **electricity** flow at which the power system would not remain in a **satisfactory state** during and following an **outage scenario**, potentially requiring involuntary post-contingency generation or **demand** reduction

system limit model means a simplified model of the **grid** that—

- (a) models a **reliability BBI's factual, counterfactual, system limits and market scenarios**; and
- (b) applies the **reliability BBI's outage scenarios** to the **factual, counterfactual, system limits and market scenarios** to model the change in **curtailed energy** between the **reliability BBI's factual and counterfactual**

TA opex means operating costs for **transmission alternatives**

tested investment means a **connection investment** or **interconnection investment** that—

- (a) was approved by the Electricity Commission under section III of Part F of the **rules**; or
- (b) was individually approved by the **Commission** as a major capex project or listed project under the **Transpower Capex IM**; or
- (c) is a base capex project to which **Transpower** was required to apply a cost-benefit analysis under the **Transpower Capex IM**

total gross energy has the meaning in subclause 4(7)

transmission charges means the charges specified in clause 2

transmission investment means an investment by **Transpower** in the **grid** or a **transmission alternative**, including such an investment for which another person contributes to the capital, maintenance, operating or other cost under an **investment agreement**

transmission services means the following services provided by a **grid owner**:

- (a) electricity lines services, as defined in section 54C of the Commerce Act 1986, but excluding **system operator** services;
- (b) the provision of **transmission alternatives**

Transpower Capex IM means the *Transpower Capital Expenditure Input Methodology Determination 2012* [2012] NZCC 2

Transpower IMs means the *Commerce Act (Transpower Input Methodologies) Determination 2010* [2012] NZCC 17

Transpower IPP means the *Transpower Individual Price-Quality Path Determination 2020* [2019] NZCC 19

Transpower operations facility means a facility that is used by **Transpower** only to operate the **grid** and is not a **station**

upgrade means, for an asset or **plant**, to alter the asset or **plant** physically so that the asset's or **plant's capacity** is permanently increased

unserved energy (measured in kWh or MWh) means an amount by which **offtake** at 1 or more **GXPs** is curtailed

unsupplied energy (measured in kWh or MWh) means an amount by which **injection** at 1 or more **GIPs** is curtailed

value of commissioned asset has the meaning in the **Transpower IMs**

value of lost load or **VOLL** means, for a **reliability BBI**—

- (a) if the **reliability BBI** is a **tested investment**, the value of **unserved energy** used when the **reliability BBI** was assessed under the **investment test**, excluding values of **unserved energy** used only for sensitivity analysis; or
- (b) otherwise—
 - (i) the applicable value of **unserved energy published** in the **assumptions book**; or
 - (ii) if there is no applicable value of **unserved energy published** in the **assumptions book**, the value of **unserved energy** referred to in subclause 4(1) of Schedule 12.2 of this Code

WACC means weighted average cost of capital

wholesale market model means a simplified model of prices and quantities in the **wholesale market for electricity** (and only in that **wholesale market**) that—

- (a) models a **market BBI's factual, counterfactual and market scenarios**; and
- (b) assumes suppliers offer prices based on their marginal variable costs of supply; and
- (c) assumes perfectly inelastic demand up to 1 or more estimated costs of self-supply that are the same for all demand types; and
- (d) applies least-cost dispatch to the **market BBI's factual, counterfactual and market scenarios**, under the assumptions in paragraphs, (b) and (c) to model the change in prices and quantities in the **wholesale market for electricity** between the **market BBI's factual and counterfactual**

write-down means a reduction in an asset's **RAB** value or **value of commissioned asset** exclusively due to damage to, or destruction, stranding, decommissioning or disposal of, the asset, which may be a partial impairment or write-off

zero RNPB investment region has the meaning in subclause 83(12).

4 Load Customers, Gross Energy and Maximum Gross Demand

- (1) The different types of **load customer** are shown in figures 1, 2, 3 and 4 below. In figures 1, 2, 3 and 4, “LN” means **local network**, “CP” means **consuming plant**, “GP” means **generating plant**, “NGN” means **non-grid network** and “POC” means a **grid point of connection**. This subclause (1) is subject to subclause (2):
 - (a) In figure 1, a **customer** owning or controlling LN, CP or GP is an **offtake customer** to the extent of the **offtake** for the relevant **trading period**:
 - (b) In figure 2, a **customer** owning or controlling LN or CP is a **direct supplied load customer** to the extent of the generated **electricity** net of any coincident **injection** through LN or CP for the relevant **trading period (embedded electricity)**. The **embedded electricity** is referred to as the **direct supplied load customer's embedded electricity** “at” POC and the relevant **connection location** for the **trading period**:
 - (c) In figure 3, a **customer** owning or controlling LN, **grid-connected CP** or **grid-connected GP** is an **indirect supplied load customer** to the extent of the generated **electricity** net of any coincident **injection** through LN or **grid-connected CP** for the relevant **trading period (embedded electricity)**. The **embedded electricity** is referred to as the **indirect supplied load customer's embedded electricity** “at” POC and the relevant **connection location** for the **trading period**:
 - (d) In figure 4, a **customer** owning or controlling GP is a **supplying load customer** to the extent of the **embedded electricity** for the relevant **trading period**. The **embedded electricity** is referred to as the **supplying load customer's embedded electricity** “at” POC and the relevant **connection location** for the **trading period**.

Figure 1

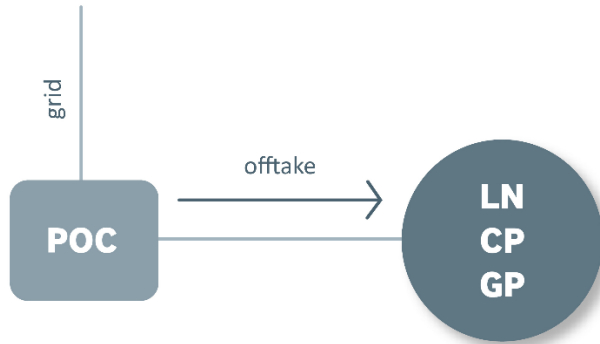

Figure 2

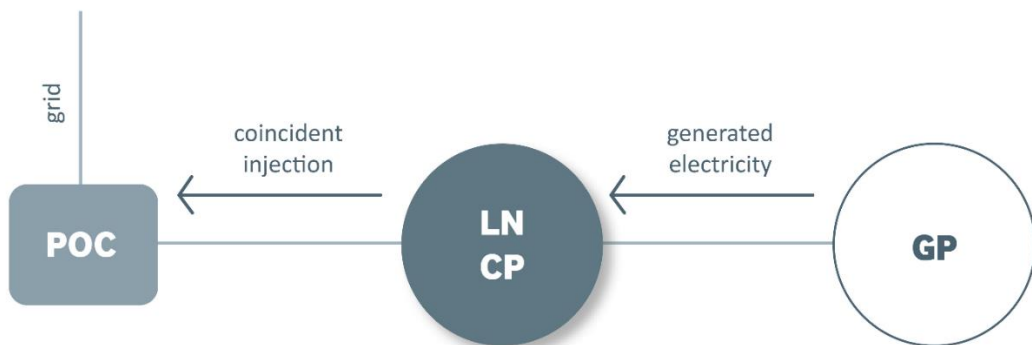
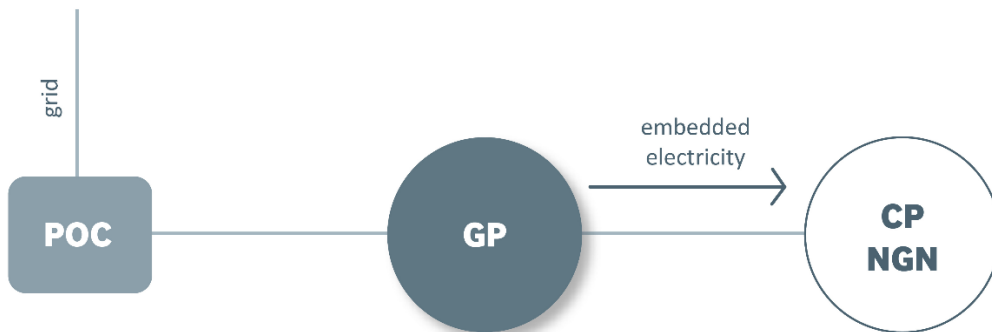

Figure 3



Figure 4



- (2) If—
- (a) GP in figure 2 above is **battery storage**, the generated **electricity** referred to in paragraph (1)(b) is deemed to be 0; or
 - (b) **embedded** GP in figure 3 above is **battery storage**, the generated **electricity** referred to in paragraph (1)(c) is deemed to be 0; or
 - (c) GP in figure 4 above is **battery storage**, the **embedded electricity** referred to in paragraph (1)(d) is deemed to be 0.
- (3) If **Transpower** determines it has insufficient information to determine whether, or the extent to which, an amount of **electricity** was generated by **battery storage**, **Transpower** must assume none of that amount of **electricity** was generated by **battery storage**.
- (4) If a configuration of **consuming plant** and **generating plant** connected to the **grid** is such that the **customer** may be treated as either a **direct supplied load customer** or **supplying load customer**, the **customer's** status as a **direct supplied load customer** or **supplying load customer** must be determined by **Transpower**.
- (5) **Gross energy** (measured in kWh or MWh) means, for a **load customer**, **connection location** or **grid point of connection**, and **trading period**—
- (a) the **load customer's** **offtake** at the **connection location** or **grid point of connection** for the **trading period**; plus
 - (b) the **load customer's** **embedded electricity** at the **connection location** or **grid point of connection** for the **trading period**.
- (6) **Maximum gross demand** (measured in kW or MW) means, for a **load customer**, **connection location** or **grid point of connection**, and period, the **load customer's** maximum per-**trading period** **gross energy** at the **connection location** or **grid point of connection** during the period multiplied by 2.
- (7) **Total gross energy** (measured in kWh or MWh) for a **load customer** and period (TGE) is calculated as follows:

$$TGE = \left(\sum_l \sum_t GE_{tl} \right) - E_{battery}$$

where

GE_{tl} is the **load customer's** **gross energy** for **trading period** t at **connection location** l during the period

$E_{battery}$ is total **injection** from all of the **load customer's** **grid-connected battery storage** over the period, if any.

5 Commissioning

- (1) An asset is **commissioned** when it is first commissioned as defined in the **Transpower IMs**.
- (2) A **connection investment** or **interconnection investment** (including a **BBI**) is **commissioned** when the first **grid asset** or **transmission alternative** comprised in it is **commissioned** or started (as the case may be).

- (3) A **connection investment** or **interconnection investment** (including a **BBI**) is **fully commissioned** when all **grid assets** and **transmission alternatives** comprised in it are **commissioned** or started (as the case may be).
- (4) Subject to subclauses (1) to (3), the time an asset, **connection investment** or **interconnection investment** (including a **BBI**) is **commissioned** or **fully commissioned** is to be determined by **Transpower**.

6 Connection and Disconnection

In this **transmission pricing methodology**, unless the context otherwise requires—

- (a) an asset becomes connected to a **network** at a **point of connection** at the time the **point of connection** is **commissioned**; and
- (b) an asset becomes disconnected from a **network** at a **point of connection** at the time the **point of connection** is **decommissioned**; and
- (c) subject to paragraphs (a) and (b), the time an asset becomes connected to or disconnected from a **network** or **plant** is to be determined by **Transpower**; and
- (d) **plant** is **grid-connected** only if it is directly connected to the **grid**; and
- (e) **embedded plant** is connected to a **local network** or **grid-connected plant** if the **embedded plant** is—
- (i) directly connected to the **local network** or **grid-connected plant**; or
- (ii) indirectly connected to the **local network** or **grid-connected plant** through other **plant** or a **non-grid network**.

7 Large Plant

Where **Transpower** is required under this **transmission pricing methodology** to assess whether **plant**, or an **upgrade** or **de-rating** of **plant**, is **large**, **Transpower** may make that assessment by combining 2 or more units of **plant** that are—

- (a) of the same type (**consuming plant** or **generating plant**); and
- (b) owned by the same person or **related parties**,

if **Transpower** determines it is reasonable in all the circumstances to do so.

8 Interpretation

In this **transmission pricing methodology**, unless the context otherwise requires—

- (a) all defined terms are shown in bold text; and
- (b) a term in bold text not defined in this **transmission pricing methodology** has the meaning given to it in Part 1 of this Code; and
- (c) any other grammatical form of a defined term has a corresponding meaning; and
- (d) if there is any inconsistency between the text description of a calculation for which there is formula and the formula, the formula takes precedence; and
- (e) if there is any inconsistency between an illustrative figure, table or associated commentary and the provisions of this **transmission pricing methodology** being illustrated by the figure, table or associated commentary, the provisions being illustrated take precedence; and
- (f) a reference to **Transpower** means **Transpower** in its capacity as a **grid owner**; and
- (g) a reference—
- (i) to the singular includes the plural and vice versa; and
- (ii) to a person includes an individual, company, other body corporate, association, partnership, firm, joint venture, trust or Crown entity; and
- (iii) to a clause, subclause, paragraph, subparagraph, Part or figure is to a clause, subclause, paragraph, subparagraph or Part of, or figure in, this **transmission pricing methodology**; and

- (iv) to any legislation, including this Code, the **Transpower IPP**, the **Transpower IMs** and the **Transpower Capex IM**, includes that legislation as amended or replaced from time to time; and
- (h) the word "including" is to be read as "including, but not limited to", and the word "includes" is to be read as "includes, without limitation"; and
- (i) a reference to a preceding **financial year** is a reference to the most recent complete **financial year** that precedes the start of the **pricing year** in respect of which the relevant calculation is undertaken or assessment is made; and
- (j) a reference to a **plant** owner is a reference to the person who owns or controls the **plant**; and
- (k) a reference to a **customer's offtake, embedded electricity or injection** at a **connection location** is a reference to the **customer's offtake, embedded electricity or injection** at all **grid points of connection** at the **connection location** where the **customer offtakes electricity, has embedded electricity or injects electricity** (as the case may be); and
- (l) a reference to a **load customer's** (including an **offtake customer's**) or **injection customer's connection location**:
 - (i) is a reference to all **grid points of connection** at the **connection location** where the **load customer offtakes electricity** or has **embedded electricity** or where the **injection customer injects electricity** (as the case may be); and
 - (ii) does not include any **connection location** where the **load customer** does not **offtake electricity** or have **embedded electricity** or where the **injection customer** does not **inject electricity** (as the case may be).

Calculation of Transmission Charges

9 Transmission Charges Calculated Separately

A **customer** may be both a **load customer** and an **injection customer** at a **connection location** (but cannot be both an **offtake customer** and **injection customer** at the **connection location** for the same **trading period**). If a **customer** is both a **load customer** and an **injection customer** at a **connection location**, the **customer's transmission charges** are calculated separately for the **customer** as a **load customer** and an **injection customer**, except as otherwise stated in this **transmission pricing methodology**.

10 Calculations and Estimations

- (1) Except as otherwise stated in this **transmission pricing methodology**—
 - (a) any calculation or estimation of a value under this **transmission pricing methodology** (including any **transmission charge**) is to be carried out by **Transpower**; and
 - (b) any input to a calculation or estimation of a value under this **transmission pricing methodology** is to be determined by **Transpower**; and
 - (c) to the extent a calculation or estimation of a value under this **transmission pricing methodology** requires modelling, **Transpower** may use the modelling tools it uses in its business from time to time, which may change over time.
- (2) To avoid doubt, **Transpower** is not required to maintain its access to a modelling tool it no longer uses in its business merely for the purpose of verifying previous calculations or estimations of values under this **transmission pricing methodology** that were made using the modelling tool.
- (3) If this **transmission pricing methodology** specifies a source for an input to a calculation or estimation of a value under this **transmission pricing methodology** but the source is not

- available or the input is not included in or provided by the source, the input is to be determined by **Transpower**.
- (4) Except as otherwise stated in this Code, **Transpower** may use the following information to calculate **allocation data** and is not required to (but may) use any other information:
- (a) **metering information**:
 - (b) information required to be provided by the **reconciliation manager** to **Transpower** under this Code, including under clause 28(b) of Schedule 15.4 of this Code:
 - (c) other **reconciled quantities** published or made available to **Transpower**:
 - (d) **half-hour metering information** required to be provided by **generators** to **Transpower** under this Code, including under clauses 13.136, 13.137 and 13.137A of this Code:
 - (e) indications and measurements required to be provided by a **participant** to the **system operator** under this Code, including under Technical Code C of Schedule 8.3 of this Code, that are published or made available to **Transpower**.
- (5) Except as otherwise stated in this **transmission pricing methodology**, **connection customer allocations**, **BBI customer allocations** and any other **transmission charge** allocators, and adjustments to those allocators, are calculated without regard to the impact of any **prudent discount** or **previous discount**.
- (6) **Transpower** must calculate or estimate all values under this **transmission pricing methodology**—
- (a) that are **connection customer allocations**, **BBI customer allocations** or other **transmission charge** allocators intended to sum to 1 or 100%, to at least 4 decimal places (if expressed as a decimal) or 2 decimal places (if expressed as a percentage), and **Transpower** is not obliged to calculate or estimate the values any more precisely than that; and
 - (b) that are in units of dollars, to 2 decimal places; and
 - (c) that are **supply** or **demand**, in whole kW; and
 - (d) that are **electricity**, in whole kWh.
- (7) If, after any methodology in this **transmission pricing methodology** is applied—
- (a) the **connection customer allocations** for a **connection asset**; or
 - (b) the **BBI customer allocations** for a **BBI**; or
 - (c) any other **transmission charge** allocators that are intended to sum to 1 or 100%, do not sum to 1 or 100%, **Transpower** must adjust all of the relevant **transmission charge** allocators on a pro rata basis to achieve a sum of 1 or 100% or as close to 1 or 100% as practicable given the precision of the **transmission charge** allocators.
- (8) The **BBI customer allocations** specified in Appendix A do not sum to 100% for every **Appendix A BBI** because they have been rounded to 2 decimal places. However, **Transpower** has calculated those **BBI customer allocations** to a greater number of decimal places and must use those more precise **BBI customer allocations**, as adjusted under this **transmission pricing methodology**, to calculate **benefit-based charges** and the **benefit factors** for the **Appendix A BBIs**. References in this **transmission pricing methodology** to an **Appendix A allocation** are to be interpreted accordingly.
- (9) If an **ID WACC**, **PQ WACC** or other regulated **WACC** is determined by the relevant regulator on a post-tax and not pre-tax basis, and a pre-tax **WACC** based on the post-tax **WACC** is required for a calculation under this **transmission pricing methodology**, the pre-tax **WACC** ($W_{\text{pre-tax}}$) must be calculated as follows:

$$W_{pre-tax} = W_{post-tax} \times \frac{1}{1 - r}$$

where

$W_{post-tax}$ is the post-tax **WACC**

r is the corporate tax rate, as defined in the **Transpower IMs**, at the relevant time.

- (10) Subclause (9) also applies to calculating a post-tax **WACC** from a regulated pre-tax **WACC**, with a corresponding change to the formula.

11 Determinations

- (1) Matters under this **transmission pricing methodology** determined by **Transpower** are determined in **Transpower's** sole discretion while acting—
- reasonably; and
 - subject to subclause (2), in accordance with **GAAP**; and
 - subject to subclause (3), with reference to—
 - information made available to **Transpower** by or on behalf of **participants** and other persons with an interest in the determination; and
 - Transpower's** and (where published) other persons' financial and regulatory records, registers and disclosures, including the **RAB**; and
 - other information relevant to the determination **Transpower** is reasonably able to obtain.
- (2) If there is any inconsistency between the requirements of **GAAP** and the requirements of this **transmission pricing methodology**, this **transmission pricing methodology** takes precedence.
- (3) **Transpower** is not required to give equal weight to the information referred to in paragraph (1)(c).

12 Reverse Flow

- (1) This clause 12 applies if all of the following conditions are satisfied:
- a **customer** has an agreement with the **system operator** under clause 6 of Technical Code A of Schedule 8.3 of this Code;
 - the **customer** has notified **Transpower** in writing that there is **reverse flow** at a **connection location** as a result of a **GXP tie** authorised under the agreement referred to in paragraph (a);
 - the **customer** notified **Transpower** under paragraph 0 within 20 **business days** of the **reverse flow** starting;
 - Transpower** is reasonably satisfied there is **reverse flow** at the **connection location** as a result of a **GXP tie** authorised under the agreement referred to in paragraph (a).
- (2) Subject to subclause (3), **Transpower** must, despite anything else in this **transmission pricing methodology**—
- adjust the **customer's allocation data** for the **connection location** to mitigate or eliminate the impact of the **reverse flow**, as determined by **Transpower**; and
 - use the adjusted **allocation data** to calculate future **transmission charges**.

- (3) Subclause (2) does not apply to any **allocation data** used to calculate **regional NPB** for a **regional customer group** under the **simple method**.
- (4) **Transpower** must **publish** the details of any adjustment it makes under subclause (2) within 20 **business days** of making the adjustment.

13 Exceptional Operating Circumstances

- (1) Subject to subclause (2), if **Transpower** determines—
 - (a) a **Transpower** requirement, **system operator** requirement, or planned or unplanned **outage** has caused exceptional operating circumstances in the power system; and
 - (b) those circumstances have resulted in a **customer's allocation data** not reflecting normal operating circumstances in the power system (a distortion),
Transpower may, despite anything else in this **transmission pricing methodology**—
 - (c) adjust the **allocation data** to mitigate or eliminate the distortion, as determined by **Transpower**; and
 - (d) use the adjusted **allocation data** to calculate future **transmission charges**.
- (2) Subclause (1) does not apply to any **allocation data** used to calculate **regional NPB** for a **regional customer group** under the **simple method**.
- (3) **Transpower** must **publish** the details of any adjustment it makes under subclause (1) within 20 **business days** of making the adjustment.

General

14 Applications, Application Fees and Application Requirements

- (1) **Transpower**—
 - (a) is not obliged to start assessing an **application**; and
 - (b) may suspend its assessment of, or reject, an **application**,
if—
 - (c) the **application fee**, if any, for the **application** has not been paid; or
 - (d) the **application** does not comply with the relevant **application requirements**; or
 - (e) the applicant otherwise does not comply, or has not complied, with this **transmission pricing methodology** in relation to the **application**.
- (2) Subject to subclause (1), **Transpower** must—
 - (a) prioritise assessment of **applications** in the order they are received by **Transpower**; and
 - (b) complete its assessment of an **application** within a reasonable time of receiving it, having regard to the complexity of the **application** and the quality of the information provided by the applicant in support of it.
- (3) Any **application fee** must be reasonable having regard to **Transpower's** expected costs of assessing **applications** of the relevant type, and may be—
 - (a) fixed or based on actual costs; and
 - (b) capped or uncapped; and
 - (c) up-front or staged; and
 - (d) refundable or non-refundable.
- (4) **Application requirements** must be reasonable having regard to the matters relevant to **Transpower's** assessment of **applications** of the relevant type.

15 Consultation on Transmission Charges

- (1) **Transpower** must consult on the following matters with at least the following groups before the relevant **transmission charges** or adjustments to them are finalised:

subject matter	minimum group to be consulted
Proposed annual connection charges	Customers who will pay the connection charges
Proposed material adjustment to connection charges during a pricing year	Customers who will pay the adjusted connection charges
Proposed starting BBI customer allocations for a post-2019 BBI expected to be high-value when fully commissioned	Public consultation
Proposed adjustment to the BBI customer allocations for a post-2019 BBI due to a SSCGU	Public consultation
Other proposed material adjustment to the BBI customer allocations for a post-2019 BBI expected to be high-value immediately before the adjustment	Customers who are or will be beneficiaries of the post-2019 BBI
Proposed allocation of residual charges for a pricing year	All load customers
Proposed material adjustment to the allocation of residual charges during a pricing year	All load customers

- (2) **Transpower** must consult publicly on the proposed **modelled regions** and **regional NPBs** under the **simple method**, and proposed **simple method factors**, for—
- (a) the first **simple method period**, before the start of the **first pricing year**; and
 - (b) each subsequent **simple method period**, before the start of the **simple method period**.
- (3) Consultation—
- (a) under subclause (1) on the proposed starting **BBI customer allocations** for a **high-value post-2019 BBI** or a proposed material adjustment to the **BBI customer allocations** for a **high-value post-2019 BBI**; and
 - (b) under subclause (2) must include information about any material departures from the assumptions and methodologies **published** in the **assumptions book** and the reasons for those departures.
- (4) Consultation under subclause (1) on—
- (a) the proposed starting **BBI customer allocations** for a **high-value post-2019 BBI**; or
 - (b) a proposed material adjustment to the **BBI customer allocations** for a **high-value post-2019 BBI**, including due to a **SSCGU**,
- must include an estimate of the **high-value post-2019 BBI's covered cost** when **fully commissioned**.

- (5) Consultation under subclause (1) or (2) may occur as part of **Transpower** or **Commission** consultation required under the **Transpower Capex IM**, other parts of this Code, or **transmission agreements**, either before or after the start of the **first pricing year**.

16 Information about Transmission Charges

- (1) **Transpower** must provide each **customer** with reasonable information that is sufficient for the **customer** to understand the basis on which the **customer's annual charges** and **monthly charges** have been calculated. For a **load customer**, this information must include, for the relevant **pricing year**—
- (a) the amount of otherwise unallocated operating costs included in **residual revenue**; and
 - (b) **reassignment amounts** included in **residual revenue**.
- (2) The information referred to in subclause (1) may be provided to a **customer** as part of **Transpower's** obligation under a **transmission agreement** to notify the **customer** of **annual charges**, **monthly charges** and changes to them, either before or after the start of the **first pricing year**.

Part B Grid Asset Classification

17 Grid Assets and Land and Buildings

- (1) Subject to subclause (3), **grid assets** are **assets** and other works (including land, easements, leases and other interests in land, buildings, containment facilities and other structures, but excluding **Transpower's** fibre optic network) that—
 - (a) comprise or support the **grid**; and
 - (b) are—
 - (i) owned by or leased to **Transpower**, provided that if the **assets** or other works are leased by **Transpower** to another person then the **assets** or other works will only be **grid assets** if **Transpower** has expressly agreed in writing with that person that the **assets** or other works are to be treated as **grid assets** for the purposes of this **transmission pricing methodology**; or
 - (ii) owned by another person and not leased to **Transpower**, but only if **Transpower** has expressly agreed in writing with that person that the **assets** or other works are to be treated as **grid assets** for the purposes of this **transmission pricing methodology**.
- (2) **Transpower's** provision of, or agreement to provide, **grid assets** that facilitate the connection of other **assets** to the **grid** does not constitute **Transpower's** agreement to treat the other **assets** as **grid assets** for the purposes of subparagraph (1)(b)(ii).
- (3) An asset that was, immediately before the start of the **first pricing year**—
 - (a) treated as a **grid asset** under the **previous transmission pricing methodology**; and
 - (b) not owned by or leased to **Transpower**,will not cease to be a **grid asset** merely because neither subparagraph (1)(b)(i) nor subparagraph (1)(b)(ii) applies to the asset.
- (4) **Land and buildings** are **grid assets** that are land, easements, leases or other interests in land, buildings, oil containment facilities, or other structures that are not comprised in the **grid**.
- (5) **Land and buildings** that support a part of the **grid** are referred to as being “part of” that part of the **grid**, together with the **grid assets** that comprise that part of the **grid**.

18 Partial Funding of Grid Assets

Subject to other legal requirements and **GAAP**, a **grid asset** the capital cost of which is partially funded under an **investment agreement**—

- (a) may be represented in **Transpower's** financial and regulatory records, registers and disclosures, including the **RAB**, as multiple **grid assets**; and
- (b) those **grid assets** may be treated as separate **grid assets** for the purposes of calculating **transmission charges**,

as necessary or convenient to ensure **Transpower** does not under-recover the total cost of the **grid asset** through this **transmission pricing methodology** and the **investment agreement**. To avoid doubt, **Transpower** must not use its discretion under this clause to over-recover the total cost of a **grid asset**.

19 Nodes and Links

- (1) A **node** is any of the following:
 - (a) a **connection location**;
 - (b) a **station** that is not a **connection location**;

- (c) a location in the **grid** where a circuit diverges or terminates (such as a “tee” point, or a deviation of a circuit within a **line** to connect to a **station** where the **line** does not terminate).
- (2) For the purposes of paragraph (1)(c)—
 - (a) a circuit does not “diverge” at a location merely because it changes direction at the location, or transitions from overhead to underground or vice versa at the location; and
 - (b) adjacent towers, poles or other structures at which a circuit diverges may be treated as a single location.
- (3) Subject to subclause (8), a **link** is either a single circuit or multiple parallel circuits (of the same voltage) that are **grid assets** and connect 2 **nodes** (and includes any **grid assets**, such as circuit breakers, that are required to connect the **link** at either **node**).
- (4) To avoid doubt—
 - (a) a **Transpower operations facility** is not a **node**; and
 - (b) a circuit or multiple parallel circuits that are **grid assets** and connect—
 - (i) a **node**; and
 - (ii) a **Transpower operations facility** that is not connected to any other **node**, is not a **link**.
- (5) Figures 5 and 6 below illustrate how **nodes** and **links** are identified under subclauses (1) to (4):
 - (a) Figure 5 shows a physical **grid** configuration. CL1, CL2 and CL3 are **connection locations**. TOF is a **Transpower operations facility**. T1, T2, T3 and T4 are towers. The lines are circuits between the **connection locations** or **Transpower operations facility** and the towers. All of the circuits are **grid assets** except the circuit between CL2 and CL3:
 - (b) Figure 6 shows the same **grid** configuration as figure 5 but in the form of **nodes** and **links**. **Nodes** N2, N4 and N5 correspond to **connection locations** CL1, CL2 and CL3 respectively. **Node** N1 corresponds to the divergence at tower T1. **Node** N3 corresponds to the divergence at towers T2 and T3, which are adjacent and treated as a single location. There is no **node** corresponding to tower T4 because the change of direction of the circuits at T4 is insufficient to constitute a divergence. There is no **node** corresponding to **Transpower operations facility** TOF because a **Transpower operations facility** is not a **node**. There is no **link** between N4 and N5 because the circuit between CL2 and CL3 is not a **grid asset**. There is no **link** between T3 and TOF because TOF is not a **node**.

Figure 5

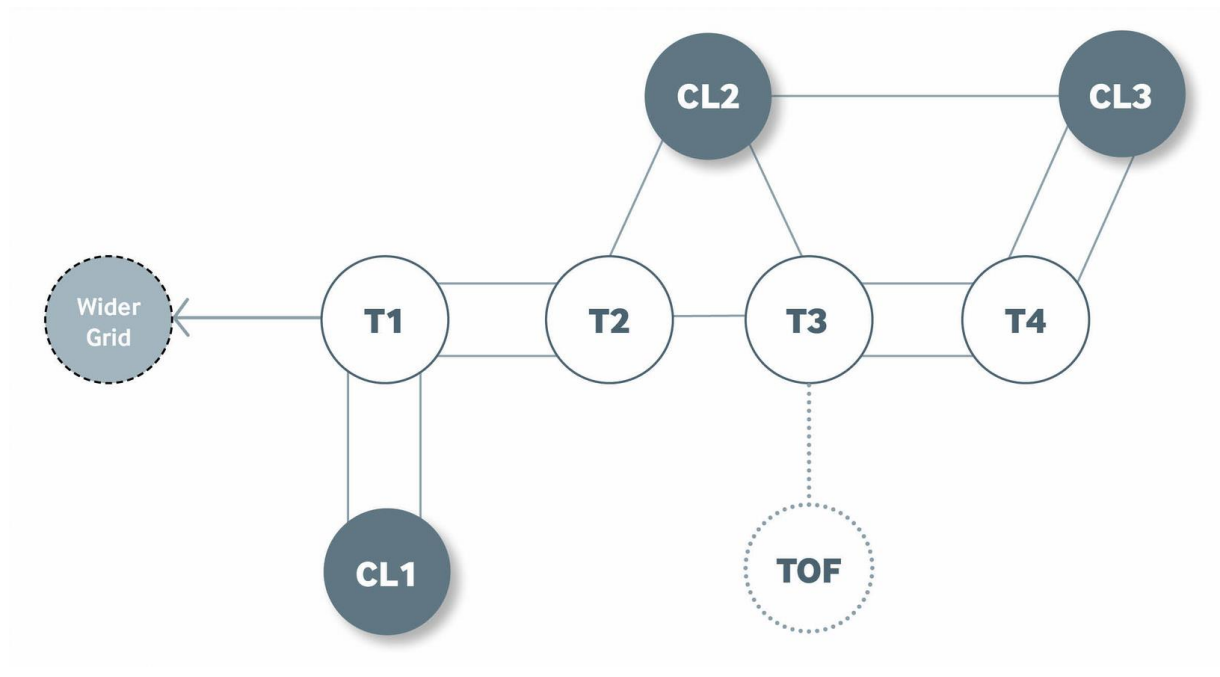
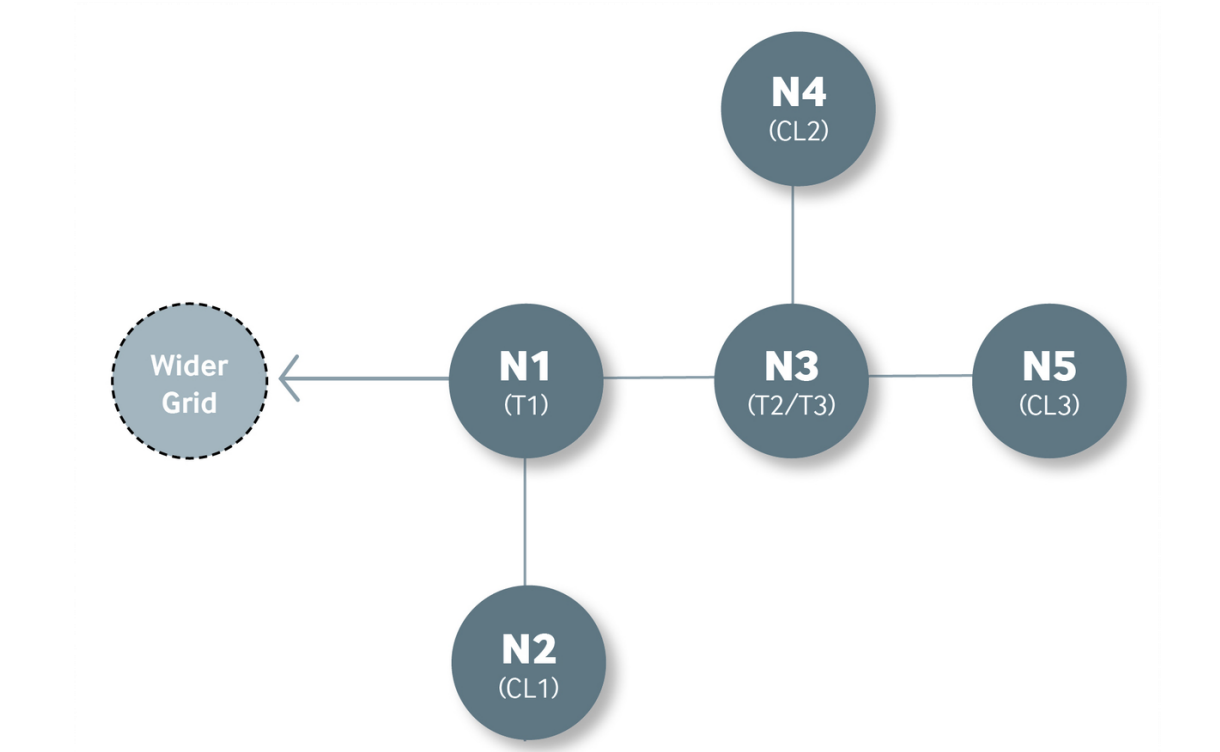

Figure 6



- (6) Subclauses (1) to (3) must be applied to identify **nodes** and **links** contemporaneously and not prospectively or retrospectively. If a **grid asset** is expected to change from being a **node** or **link** to not being a **node** or **link**, or vice versa, once a future event occurs (such as the

commissioning or **decommissioning** of it or another **asset**), that does not affect the **node** or **link** status of the **grid asset** before the event occurs.

- (7) Subject to subclause (8), if a **grid asset** was a **node** or **link** before this **transmission pricing methodology** came into effect or before an event occurred, that does not prevent the **grid asset** ceasing to be a **node** or **link** when this **transmission pricing methodology** came into effect or when the event occurred, or vice versa.
- (8) A circuit or circuits that are not **grid assets** but, immediately before this **transmission pricing methodology** came into effect, comprised a “link” under the **previous transmission pricing methodology**—
- (a) will be treated as a **link** despite not being **grid assets**; but
 - (b) will cease to be a **link** if the circuit or circuits otherwise cease to meet the requirements for comprising a **link** under this **transmission pricing methodology**.

20 Connection and Interconnection Nodes and Links

- (1) **Nodes** and **links** are identified as **connection nodes** or **connection links** or **interconnection nodes** or **interconnection links** according to the following rules:
- (a) an **interconnection node** is any **node** connected to 2 or more **nodes** in a **loop**, other than a **small regional loop**;
 - (b) a **loop** is a continuous path of **nodes** and **links** with the same start and end **node**;
 - (c) a **small regional loop** is a **loop** between any group of **nodes** (excluding the **nodes** at the Benmore and Haywards substations) with only a single **link** from the **loop** to a **node** outside the **loop** that—
 - (i) is part of another **loop**; or
 - (ii) ultimately links to another **loop**, either directly or indirectly through other **nodes**;
 - (d) a connection node is any node that is not an interconnection node, including all nodes in a small regional loop;
 - (e) a **connection link** is a **link** with a **connection node** at 1 or both of its ends;
 - (f) an **interconnection link** is a **link** that connects 2 **interconnection nodes**.
- (2) Figures 7, 8 and 9 below illustrate how **small regional loops**, **interconnection nodes** and **links**, and **connection nodes** and **links** are identified under subclause (1):
- (a) In figures 7 and 8, **nodes** N2, N3 and N4 comprise a **small regional loop** because in each case there is only 1 **link** (from N4) to another **loop**. In figure 7, the **link** from N4 to the other **loop** is direct because **interconnection node** N6 is part of the other **loop**. In figure 8, the **link** from N4 to the other **loop** is indirect through **connection node** N5. In figures 7 and 8, N2, N3 and N4 are **connection nodes** and the **links** between and to them are **connection links**. In figure 8, the **link** from N5 to N6 is also a **connection link**;
 - (b) In figure 9, **nodes** N2, N3 and N4 do not comprise a **small regional loop** because there is more than 1 **link** (from N3 and N4) to another **loop**. Even if the **link** from N4 to N6 did not exist, N2, N3 and N4 would still not comprise a **small regional loop** because there are 2 **links** to another **loop** from N3. In figure 9, N2, N3 and N4 are **interconnection nodes** and (apart from the **link** from **connection node** N1 to N2, which is a **connection link**) the **links** between and to them are **interconnection links**.

Figure 7

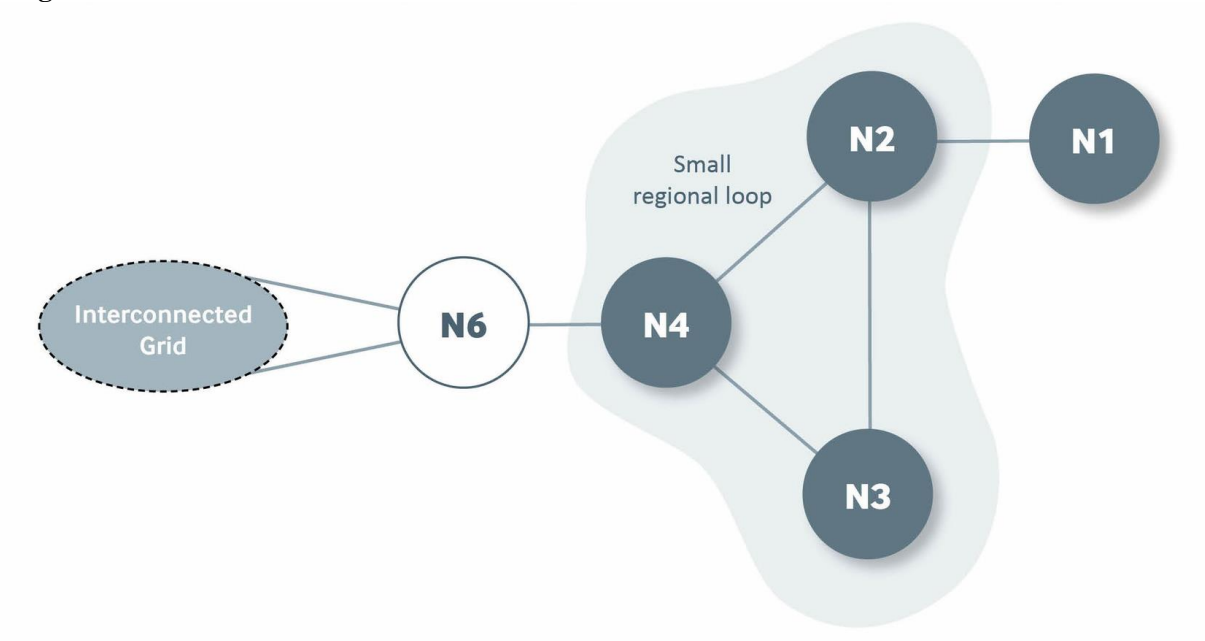

Figure 8

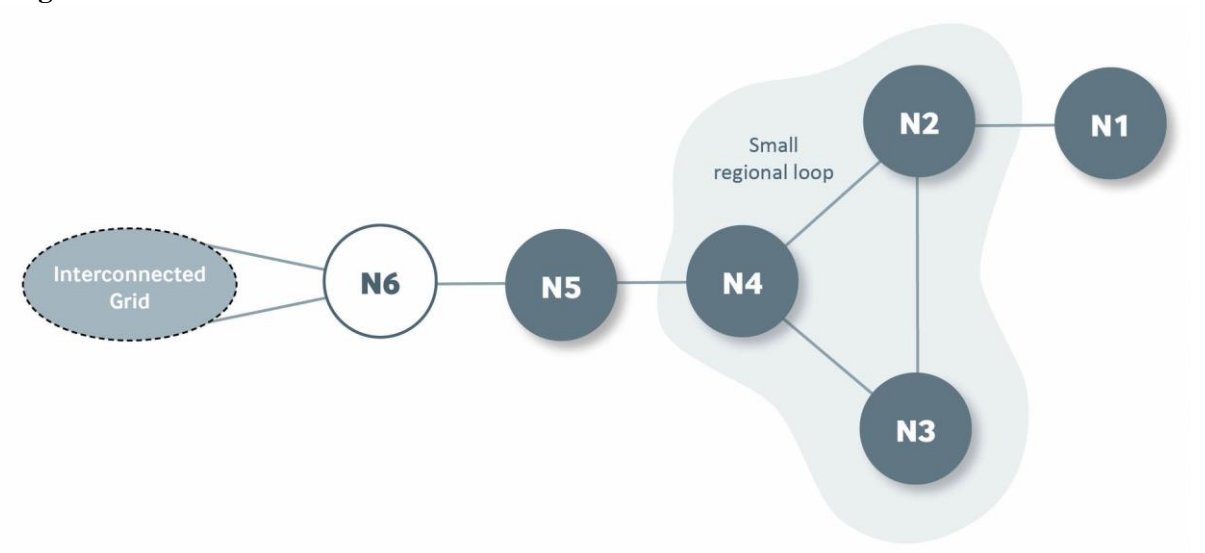
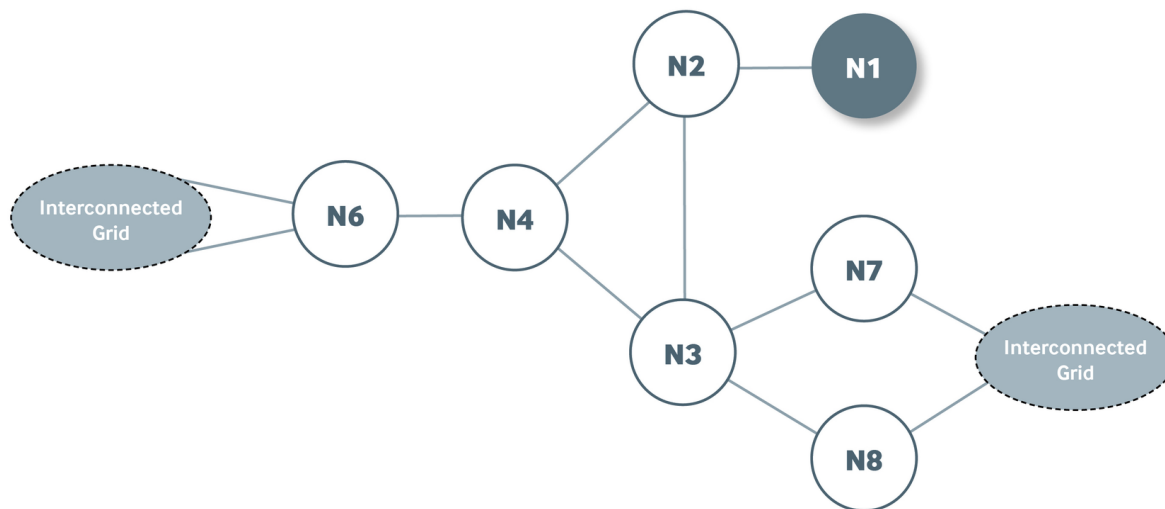

Figure 9



- (3) Subject to subclause (4), subclause (1) must be applied to classify **nodes** and **links** contemporaneously and not prospectively or retrospectively. If a **node** or **link** is expected to change from a **connection node** or **link** to an **interconnection node** or **link**, or vice versa, once a future event occurs (such as the **commissioning** or **decommissioning** of it or another **asset**), that does not affect the classification of the **node** or **link** before the event occurs.
- (4) If a group of **nodes** or **links** that are to be provided as part of the same project are **commissioned** in a staged manner, the **connection** or **interconnection** status of each **node** and **link** in the group must be determined prospectively based on all **nodes** and **links** in the group being **commissioned**. However—
- (a) if all the **nodes** and **links** have not been **commissioned** by the start of the **pricing year** that is at least 9 months after the first **node** or **link** is **commissioned**—
- (i) subclause (3) will apply from the start of that **pricing year** and not this subclause (4) (so that the **nodes** and **links** will be classified contemporaneously from the start of that **pricing year**); and
- (ii) once all the **nodes** and **links** are **commissioned**, subclause (3) will apply from the start of the first **pricing year** that starts after the last **node** or **link** is **commissioned** (so that the **nodes** and **links** will be classified contemporaneously from the start of that **pricing year**); and
- (b) this subclause (4) must not be applied to classify an **interconnection node** or **interconnection link** as a **connection node** or **connection link**.
- (5) If a **node** or **link** was classified as a **connection node** or **link** before this **transmission pricing methodology** came into effect or before an event occurred, that does not prevent the **node** or **link** being re-classified as an **interconnection node** or **link** when this **transmission pricing methodology** came into effect or when the event occurred, or vice versa.

21 Connection and Interconnection Assets

- (1) A **connection asset** is any of the following that is not an **HVDC asset**:
- (a) a **grid asset** at a **connection node**, other than voltage support equipment that is not an **investment agreement asset**;
- (b) at an **interconnection node** that is a **connection location**—
- (i) any **grid asset** that is used to connect a **customer's assets** to the **grid**. This may include:

- (A) a supply transformer, feeder bay, or supply transformer high voltage or low voltage breaker:
 - (B) a low voltage breaker, low voltage bus section breaker, voltage transformer, revenue meter, or other equipment that is on the same bus as a feeder; and
- (ii) a proportion of the **land and buildings** at the **connection location** (LB_{conn}) calculated as follows:

$$LB_{conn} = \frac{RC_{conn\ total}}{RC_{total}}$$

where

$RC_{conn\ total}$ is the total **replacement cost** of all **grid assets** described in subparagraph (i) at the **connection location** at the end of the preceding **financial year**

RC_{total} is the total **replacement cost** of all **grid assets** (excluding **land and buildings**) at the **connection location** at the end of the preceding **financial year**:

- (c) a **grid asset** that is part of a **connection link**. If a **line** is included in a **connection link** and 1 or more other **links**, the part of the **line** ascribed to the **connection link** must be determined according to the length of the **line** included in the **connection link** relative to the total length of the **line**.
- (2) An **interconnection asset** is any **grid asset** that is not a **connection asset**, and includes any **HVDC asset**.

22 Associating Connection Assets with Connection Locations and Customers

- (1) A **connection asset** that—
- (a) is at a **connection location**; or
 - (b) if the **connection location** is a **connection node**, connects the **connection location** (directly or indirectly) to an **interconnection node**,
- is referred to as a **connection asset** "for" the **connection location**, "that connects" (or other grammatical form of that phrase) the **customers** at the **connection location** and that those **customers** are "connected to" (or other grammatical form of that phrase).
- (2) A **customer** who owns or controls **assets** connected at a **connection location** is referred to as a **customer** "at" the **connection location**.
- (3) Subject to subclause (4), a **connection asset** for a **connection location** is referred to as "shared" between the **customers** at the **connection location**.
- (4) A **connection asset** at a **connection location** that connects a specific **customer** only is not shared with any other **customer**.
- (5) Figure 10 below is the **node** and **link** configuration in figure 7 above and illustrates how **connection assets** are associated with **connection locations** and **customers** under subclauses (1) to (3):
- (a) N1, N3, N4 and N6 are **connection locations** at which **customers** A, B, C, D and E are connected. The smaller circles within N1, N3, N4 and N6 are **connection assets** at those **connection locations** that connect the specific **customers** shown only:

Electricity Industry Participation Code 2010
Schedule 12.4

(b) The following table shows which **connection assets** are “for” the **connection locations** at N1, N3, N4 and N6. The **links** with an asterisk are “deep” **connection assets** for the relevant **connection location** because they are not located at, and do not directly connect to, the **connection location**:

connection assets	N1	N3	N4	N6
at connection location	Y	Y	Y	Y
in link N1-N2	Y	N	N	N
in link N2-N3	Y*	Y	N	N
in link N3-N4	Y*	Y	N	N
in link N2-N4	Y*	Y*	N	N
in link N4-N6	Y*	Y*	Y	N

(c) The following table shows how the **connection assets** at and between N1, N2, N3, N4 and N6 are “shared” between **customers** A, B, C, D and E:

connection assets	sharing
at N1	shared between A and B, apart from A- or B-specific connection assets
at N2	shared between A, B and C
at N3	shared between A, B and C, apart from C-specific connection assets
at N4	shared between A, B, C and D, apart from D-specific connection assets
at N6	shared between A, B, C, D and E, apart from E-specific connection assets
in link N1-N2	shared between A and B
in link N2-N3	shared between A, B and C
in link N3-N4	shared between A, B and C
in link N2-N4	shared between A, B and C
in link N4-N6	shared between A, B, C and D

Figure 10

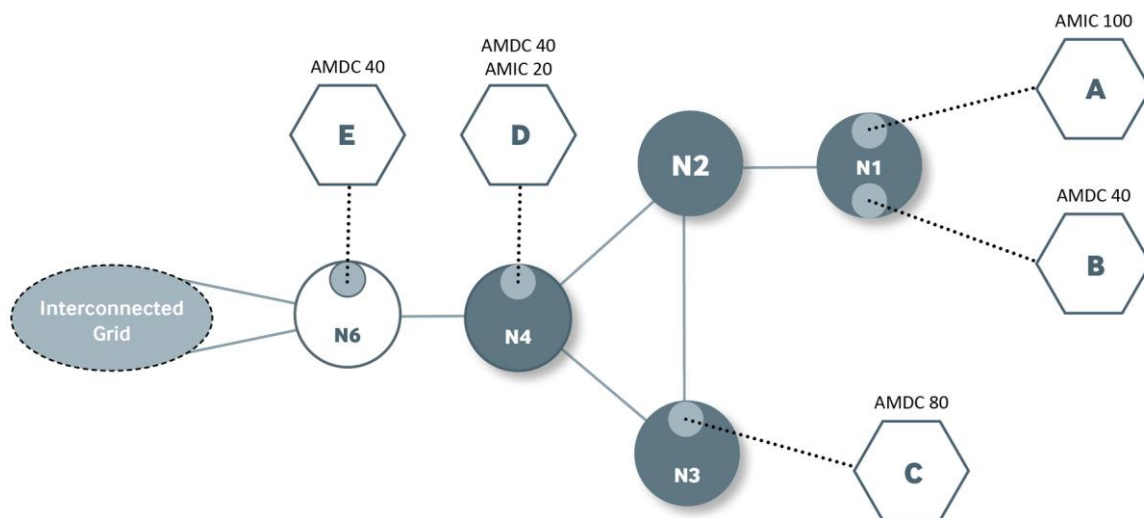

23 Discretion to Classify and Reclassify as Connection Asset

- (1) Despite anything else in this **transmission pricing methodology**, **Transpower** may classify or (subject to subclause (2)) reclassify any **grid asset** that would otherwise be an **interconnection asset** as a **connection asset** if **Transpower** determines—
 - (a) the **grid asset** provides or will provide **transmission services** to 1 or more **customers** of a type and nature typically provided by **connection assets**; and
 - (b) the **grid asset** does not provide or will not provide any material **transmission services** of a type and nature typically provided by **interconnection assets**; and
 - (c) it is reasonable in all the circumstances to classify or reclassify the **grid asset** as a **connection asset**.
- (2) **Transpower** must not reclassify a **grid asset** as a **connection asset** under subclause (1) retrospectively.
- (3) **Transpower** must—
 - (a) before classifying or reclassifying a **grid asset** as a **connection asset** under subclause (1), consult with all **customers** who will be connected to the **grid asset**. This consultation may occur either before or after the start of the **first pricing year**; and
 - (b) notify those **customers** of **Transpower's** decision whether or not to classify or reclassify the **grid asset** as a **connection asset** under subclause (1).
- (4) A **customer** referred to in subclause (3) may, within 20 days of **Transpower** notifying the **customer** of **Transpower's** decision, refer **Transpower's** decision under subclause (1) to an **independent expert** for review.
- (5) The **independent expert's** decision will be binding on **Transpower** and the **customer**, and will have effect as if **Transpower** had made the decision itself, except that the **customer** may not refer the decision to an **independent expert** again.
- (6) The costs of the **independent expert** must be met by the **customer** unless the **independent expert** decides **Transpower's** decision was unreasonable, in which case **Transpower** may be required to meet all or some of the costs of the **independent expert**, as determined by the **independent expert**.

Part C Connection Charges

24 Calculation of Connection Charges

- (1) Only **customers** connected to **connection assets** pay **connection charges**.
- (2) A **customer's annual connection charge** for a **connection asset**, **connection location** and **pricing year** (CC) is calculated as follows:

$$CC = ((A + FA + M + O) \times CA) - RBT$$

where

A is the **asset component** for the **connection asset** and **pricing year** calculated under clause 26

FA is the **customer's funded asset component** for the **connection asset** and **pricing year** calculated under clause 28

M is the **maintenance component** for the **connection asset** and **pricing year** calculated under clause 30

O is the **operating component** for the **connection asset** and **pricing year** calculated under clause 31

CA is the **customer's connection customer allocation** for the **connection asset**, **connection location** and **pricing year**

RBT is the **customer's funded asset rebate** for the **connection asset**, **connection location** and **pricing year** calculated under clause 29.

- (3) A **customer's annual connection charge** for a **connection location** and **pricing year** (ACC) is calculated as follows:

$$ACC = \sum_a CC_a$$

where CC_a is the **customer's annual connection charge** for **connection asset a** for the **connection location** and **pricing year**.

- (4) A **customer's annual connection charge** for a **connection transmission alternative** and **pricing year** (TACC) is calculated as follows:

$$TACC = TAC \times \frac{\sum_l ACC_l}{\sum_l ACC_{l\ total}}$$

where

TAC is the **TA opex** for the **connection transmission alternative** and preceding **financial year**, less any contribution to the **TA opex** under **investment agreements**

ACC_l is the **customer's annual connection charge** for **connection location l** and the previous **pricing year**, where **connection location l** is a **connection location** that would be connected by a **connection asset** for which the **connection transmission alternative** is an alternative

$ACC_{l\ total}$ is the total of all **customers' annual connection charges** for **connection location l** and the previous **pricing year**.

- (5) A **customer's monthly connection charge** for a **pricing year** (MCC) is calculated—
(a) for a **connection location**, as follows:

$$MCC = \frac{ACC}{12}$$

where ACC is the **customer's annual connection charge** for the **connection location** and **pricing year**; and

- (b) for a **connection transmission alternative**, as follows:

$$MCC = \frac{TACC}{12}$$

where TACC is the **customer's annual connection charge** for the **connection transmission alternative** and **pricing year**.

- (6) **Connection charges** are calculated for each **pricing year** before the start of the **pricing year**.
(7) A **connection charge** may be adjusted, including during a **pricing year**, under clauses 76 to 80 if there is a **connection charge adjustment event**.

25 Start of Connection Charges

Except as otherwise required under any relevant **transmission agreement**, **Transpower** must start the **connection charges** for a **connection investment** from the **connection investment's start pricing year**. To avoid doubt, this clause does not apply to charges under an **investment agreement**.

Clause 25: amended, on 31 July 2023, by clause 6 of the Electricity Industry Participation Code Amendment (Transmission Pricing Methodology Amendments) 2023.

26 Asset Component

- (1) Subject to subclause (2), **Transpower** may designate a **connection asset**, or an actual or notional part of a **connection asset**, as anticipatory for a **pricing year** if—
(a) the **connection asset** or part of the **connection asset** was **commissioned** at or after the start of the **first pricing year**; and
(b) **Transpower** determines that the **connection asset** or part of the **connection asset** is not likely to be required during the **pricing year** by the **customers** connected to the **connection asset**.
- (2) Once **Transpower** has designated a notional part of a **connection asset** as anticipatory for a **pricing year** under subclause (1), **Transpower** must not designate a greater notional part of the **connection asset** or the whole **connection asset** as anticipatory for any subsequent **pricing year**.
- (3) A **connection asset** or part of a **connection asset** designated as anticipatory for a **pricing year** under subclause (1) is an **anticipatory connection asset** for the **pricing year**. If the **anticipatory connection asset** is part of a larger **connection asset** then, for the purposes of

this clause 26 and clause 27, the larger **connection asset** is treated as two separate **connection assets** for the **pricing year**, being the **anticipatory connection asset** and the part of the larger **connection asset** that is not anticipatory for the **pricing year**.

- (4) Whether or not a **connection asset** or part of a **connection asset** is an **anticipatory connection asset** for a **pricing year** must be determined by **Transpower** having regard to the extent to which—
- (a) the **customers** connected to the **connection asset** have agreed to fund the **connection asset** under **investment agreements**; and
 - (b) the **connection asset** is likely to be required to meet the requirements of the **customers** connected to the **connection asset** and cover reasonable **grid** contingencies during the **pricing year**.
- (5) Half of the capital cost of an **anticipatory connection asset** is recovered through the asset component of **connection charges**. The other half of the capital cost of the **anticipatory connection asset** is recovered through **benefit-based charges** for the relevant **anticipatory BBI** (see clause 27).
- (6) The asset component of the **connection charge** for a **connection asset** and **pricing year** (A) allocates a portion of the capital cost of all **connection assets** to the **connection asset**, and is calculated as follows:

$$A = (ARR \times RC) + (DARR \times RC')$$

where

ARR is the **connection asset** return rate for the **pricing year** calculated under subclause (7)

RC is—

- (a) 0 if the **connection asset** is an **investment agreement asset** or **anticipatory connection asset**; or
- (b) otherwise, the **replacement cost** of the **connection asset** at the end of the preceding **financial year**

DARR is the discounted **connection asset** return rate for the **pricing year** calculated under subclause (8)

RC' is—

- (a) 0 if the **connection asset** is an **anticipatory connection asset**; or
- (b) otherwise, the **replacement cost** of the **connection asset** at the end of the preceding **financial year** (even if the **connection asset** is an **investment agreement asset**).

- (7) The **connection asset** return rate for a **pricing year** (ARR) is calculated as follows:

$$ARR = \frac{(r \times (V_{total} - V_{total\ anticipatory})) + (D_{total} - D_{total\ anticipatory})}{RC_{total}}$$

where

r is **Transpower's PQ WACC** (pre-tax) for the **pricing year**

V_{total}	is the total closing RAB value of all connection assets for the preceding financial year
$V_{total\ anticipatory}$	is the part of V_{total} attributable to anticipatory connection assets , as determined by Transpower
D_{total}	is total depreciation of all connection assets other than investment agreement assets during the preceding financial year , excluding accelerated depreciation
$D_{total\ anticipatory}$	is the part of D_{total} attributable to anticipatory connection assets , as determined by Transpower
RC_{total}	is the total replacement cost of all connection assets other than investment agreement assets and anticipatory connection assets at the end of the preceding financial year .

- (8) The discounted **connection asset** return rate for a **pricing year** (DARR) is calculated as follows:

$$DARR = \frac{(r \times V_{total\ anticipatory}) + D_{total\ anticipatory}}{RC'_{total}} \times 0.5$$

where

r	is Transpower's PQ WACC (pre-tax) for the pricing year
$V_{total\ anticipatory}$	is the part of the total closing RAB value of all connection assets for the preceding financial year attributable to anticipatory connection assets , as determined by Transpower
$D_{total\ anticipatory}$	is the part of total depreciation of all connection assets other than investment agreement assets during the preceding financial year , excluding accelerated depreciation , attributable to anticipatory connection assets , as determined by Transpower
RC'_{total}	is the total replacement cost of all connection assets (including connection assets that are investment agreement assets) other than anticipatory connection assets at the end of the preceding financial year .

Clause 26(4)(a) and (b): amended, on 31 July 2023, by clause 7 of the Electricity Industry Participation Code Amendment (Transmission Pricing Methodology Amendments) 2023.

27 Anticipatory BBIs

- (1) The **benefit-based charges** for **anticipatory BBIs** recover the part of the capital cost of **anticipatory connection assets** that is not recovered through the asset component of **connection charges**, specifically half of that capital cost.
- (2) For each **anticipatory connection asset** for a **pricing year** there is deemed to be a **commissioned BBI** (an **anticipatory BBI**) for the **pricing year** (only for the purpose of recovering half of the capital cost of the **anticipatory connection asset**)—
 - (a) that comprises the **anticipatory connection asset**; and
 - (b) that has a **covered cost** for the **pricing year** (CVC) calculated as follows:
- (3)

$$CVC = \left((r \times V_{anticipatory}) + D_{anticipatory} \right) \times 0.5$$

where

r is **Transpower's PQ WACC** (pre-tax) for the **pricing year**

$V_{anticipatory}$ is the part of the total **closing RAB value** for the preceding **financial year** attributable to the **anticipatory connection asset**, as determined by **Transpower**

$D_{anticipatory}$ is the part of total **depreciation** during the preceding **financial year**, excluding **accelerated depreciation**, attributable to the **anticipatory connection asset**, as determined by **Transpower**; and

- (c) for which the **start pricing year** is the **pricing year**; and
 - (d) for which a **customer's individual NPB** is calculated under the **simple method**, subject to the modifications in subclause (3) and even if the **anticipatory BBI's** deemed **covered cost** for the **pricing year** under paragraph (b) is more than the base capex threshold as defined in the **Transpower Capex IM**.
- (3) The modifications referred to in paragraph 2(d) are as follows:
- (a) If **Transpower** determines the **anticipatory BBI** is primarily to allow for a future increase in **offtake**, the **anticipatory BBI's regional customer groups** are limited to **regional supply groups**;
 - (b) If **Transpower** determines the **anticipatory BBI** is primarily to allow for a future increase in **injection**, the **anticipatory BBI's regional customer groups** are limited to **regional demand groups**.

28 Funded Asset Component

- (1) The **funded asset** component of the **connection charge** ensures that **non-contributing customers** pay part of the capital cost of **funded assets** through their **connection charges**.
- (2) A **customer's funded asset** component for a **connection asset** is 0 unless—
 - (a) the **connection asset** is a **funded asset**; and
 - (b) the **customer** is, but for the **funded asset** component, a **non-contributing customer** for the **funded asset**.
- (3) Subject to subclauses (4) and (5), a **non-contributing customer's funded asset** component for a **funded asset** and **pricing year** (FA) is calculated as follows:

$$FA = TF \times \frac{EL_{remain}}{EL_{total}} \times \frac{1}{10}$$

where

TF is the total amount paid, or expected to be paid, towards the capital cost of the **funded asset** under all **investment agreements**

EL_{remain} is the remaining **economic life** of the **funded asset** at the end of the **pricing year** during which the **non-contributing customer** connected to the **funded asset**

EL_{total} is the total **economic life** of the **funded asset**, including any part of it that has elapsed.

- (4) The **non-contributing customer's funded asset** component for the **funded asset** applies for 10 consecutive **pricing years** only, starting with the **pricing year** after the **pricing year** during which the **non-contributing customer** connected to the **funded asset**.
- (5) If the **non-contributing customer** agrees with 1 or more **prior contributing customers** to contribute towards the capital cost of a **funded asset**—
- (a) subclause (3) applies to the **funded asset** subject to that agreement; and
 - (b) the agreement is deemed to be an **investment agreement** for the **funded asset** (even if **Transpower** is not a party to it).

29 Funded Asset Rebate

- (1) A **non-contributing customer's funded asset** component for a **funded asset** and **pricing year** is rebated to each **prior contributing customer** for the **funded asset** in respect of the **non-contributing customer**.
- (2) A **customer's funded asset** rebate for a **connection asset** and **pricing year** is 0 unless—
- (a) the **connection asset** is a **funded asset**; and
 - (b) a **non-contributing customer** pays a **funded asset** component for the **funded asset** and **pricing year**; and
 - (c) the **customer** is a **prior contributing customer** for the **funded asset** in respect of the **non-contributing customer**.
- (3) Subject to subclause (4), **prior contributing customer c's funded asset** rebate of **non-contributing customer i's funded asset** component for a **connection location** and **pricing year** (RBT_c) is calculated as follows:

$$RBT_c = FA_i \times CA_i \times \frac{CA_c}{CA_{prior\ total}}$$

where

FA_i is **non-contributing customer i's funded asset** component for the **funded asset** and **pricing year**

CA_i is **non-contributing customer i's connection customer allocation** for the **funded asset, connection location** and **pricing year**

CA_c is **prior contributing customer c's connection customer allocation** for the **funded asset, connection location** and **pricing year**

$CA_{prior\ total}$ is the total of all **prior contributing customers' (including prior contributing customer c's) connection customer allocations** for the **funded asset, connection location** and **pricing year**.

- (4) Subclause (3) applies subject to any agreement of the type referred to in subclause 28(5).

30 Maintenance Component

- (1) The maintenance component of the **connection charge** for a **connection asset** and **pricing year** (M) allocates to the **connection asset** a portion of **Transpower's** total maintenance costs for all **connection assets**, and is calculated as follows:

$$M = MC \times (1 - ICR_{\text{maint}})$$

where

MC is the maintenance cost component for the **connection asset** and **pricing year** calculated under subclause (2)

ICR_{maint} is the percentage of the maintenance cost for the **connection asset** and **pricing year** expected to be recovered by **Transpower** under **investment agreements**, expressed as a decimal and no more than 1.

- (2) The maintenance cost component for the **connection asset** and **pricing year** (MC) is—
- if the **connection asset** is located at a **station**, the **station** maintenance cost component for the **pricing year** calculated under subclause (3); or
 - if the **connection asset** is a **line**, the **line** maintenance cost component for the **pricing year** calculated under subclause (5).
- (3) The **station** maintenance cost component for the **connection asset** and **pricing year** (MC_{station}) is calculated as follows:

$$MC_{\text{station}} = MRR_{\text{station}} \times RC$$

where

MRR_{station} is the **station** maintenance recovery rate for the **pricing year** calculated under subclause (4)

RC is the **replacement cost** of the **connection asset** at the end of the preceding **financial year**.

- (4) The **station** maintenance recovery rate for a **pricing year** (MRR_{station}) is calculated as follows:

$$MRR_{\text{station}} = \frac{AMC_{\text{station total}}}{RC_{\text{station total}}}$$

where

AMC_{station total} is the average over the preceding 4 **financial years** of **Transpower's** maintenance costs for all **connection assets** located at **stations**

RC_{station total} is the total **replacement cost** of all **connection assets** located at **stations** at the end of the preceding **financial year**.

- (5) The **line** maintenance cost component is calculated using a **line** maintenance recovery rate that depends on the **line** type. The different **line** types (all AC) used are—
- 220kV or higher voltage tower **lines**; and
 - other tower **lines**; and
 - pole **lines**; and
 - underground cable **lines**.
- (6) The **line** maintenance cost component for the **connection asset** and **pricing year** (MC_{line}) is calculated as follows:

$$MC_{line} = MRR_{line\ t} \times L$$

where

$MRR_{line\ t}$ is the **line** maintenance recovery rate for the **connection asset's line** type t and the **pricing year** calculated under subclause (7)

L is the **line** length (in km) of the **connection asset** at the end of the preceding **financial year**.

- (7) Subject to subclause (8), the **line** maintenance recovery rate for **lines** of type t and a **pricing year** ($MRR_{line\ t}$) is calculated as follows:

$$MRR_{line\ t} = \frac{AMC_{line\ t\ total}}{L_{t\ total}}$$

where

$AMC_{line\ t\ total}$ is the average over the preceding 4 **financial years** of **Transpower's** maintenance costs for all **connection assets** that are **lines** of type t

$L_{t\ total}$ is the total **line** length (in km) of all **connection assets** that are **lines** of type t at the end of the preceding **financial year**.

- (8) **Transpower** may estimate the **line** maintenance recovery rate for underground cable **lines** if **Transpower** determines it has insufficient data to carry out the calculation in subclause (7) for underground cable **lines**.

31 Operating Component

- (1) The operating component of the **connection charge** for a **connection asset** and **pricing year** (O) allocates to the **connection asset** a portion of **Transpower's** total operating costs for all **AC assets**, and is calculated as follows:

$$O = OC \times (1 - ICR_{op})$$

where

OC is the operating cost component for the **connection asset** and **pricing year** calculated under subclause (2)

ICR_{op} is the percentage of the operating cost for the **connection asset** and **pricing year** expected to be recovered by **Transpower** under **investment agreements**, expressed as a decimal and no more than 1.

- (2) The operating cost component for the **connection asset** and **pricing year** (OC) is calculated as follows:

$$OC = ORR \times (S - (0.1 \times S_{cust}))$$

where

ORR is the operating recovery rate for the **pricing year** calculated under subclause (3)

S is the number of switches that are part of the **connection asset** at the end of the preceding **financial year**

S_{cust} is the number of switches that are part of the **connection asset** and operated by a **customer** at the end of the preceding **financial year**.

- (3) The operating recovery rate for the **pricing year** (ORR) is calculated as follows:

$$ORR = \frac{OC_{switch\ total}}{(S_{total} - (0.1 \times S_{cust\ total}))}$$

where

$OC_{switch\ total}$ is **Transpower's** total operating costs for all **AC switches** over the preceding **financial year**

S_{total} is the total number of **AC switches** at the end of the preceding **financial year**

$S_{cust\ total}$ is the total number of **AC switches** that are operated by a **customer** at the end of the preceding **financial year**.

32 Connection Customer Allocations

- (1) Subject to subclause (5) and clause 33, a **customer's connection customer allocation** for a **connection asset, connection location** and **pricing year** (CA_1) is calculated as follows if the **connection asset** is—

- (a) for 1 **connection location** only; and
(b) not a **mixed connection asset**:

$$CA_1 = \frac{AMDIC}{AMDIC_{total}}$$

where

$AMDIC$ is the total of the **customer's** **AMDC** and **AMIC** at the **connection location** for the **pricing year**

$AMDIC_{total}$ is the total of all **customers' AMDCs** and **AMICs** at the **connection location** for the **pricing year**.

- (2) Subject to subclause (5) and clause 33, a **customer's connection customer allocation** for a **connection asset, connection location** and **pricing year** (CA_{2+}) is calculated as follows if the **connection asset** is—

- (a) for 2 or more **connection locations**, being the set of **connection locations** L ; and
(b) not a **mixed connection asset**:

$$CA_{2+} = \frac{AMDIC}{AMDIC_{L\ total}}$$

where

AMDIC is the total of the **customer's AMDC** and **AMIC** at the **connection location** for the **pricing year**

AMDIC_{L total} is the total of all **customers' AMDCs** and **AMICs** at all **connection locations** in the set of **connection locations L** for the **pricing year**.

- (3) Subject to subclauses (4) and (5) and clause 33, a **customer's connection customer allocation** for a **connection asset, connection location** and **pricing year** (CA_{mixed}) is calculated as follows if the **connection asset** is a **mixed connection asset**:

$$CA_{mixed} = \frac{AMDIC}{C}$$

where

AMDIC is the total of the **customer's AMDC** and **AMIC** at the **connection location** for the **pricing year**

C is the **capacity** of the **connection asset** at the end of **CMP A** for the **pricing year**.

- (4) If the sum of all **customers' connection customer allocations** for a **mixed connection asset** and **pricing year** is greater than 1, **Transpower** must scale down all of the **connection customer allocations** on a pro rata basis so that they sum to 1.
- (5) If a **connection asset** is—
- (a) an **investment agreement asset** provided under an **investment agreement** with a **customer**; and
 - (b) for more than 1 **connection location**, or for 1 **connection location** at which there is more than 1 **customer**,
- then the calculation of the **connection customer allocations** for the **connection asset** and **connection locations** is subject to any provisions in the **investment agreement** that alter the **customer's connection customer allocation** for the **connection asset** and **connection locations**.
- (6) The following table shows the **connection customer allocations** for the **connection assets** that are part of the **connection links** in figure 10 above (based on the **AMDC** and **AMIC** quantities shown in figure 10):

link	connection location	customer	connection customer allocation
N1-N2	N1	A	$\frac{100}{140} = 0.7143$
		B	$\frac{40}{140} = 0.2857$
N2-N3 N3-N4 N2-N4	N1	A	$\frac{100}{220} = 0.4545$
		B	$\frac{40}{220} = 0.1818$
	N3	C	$\frac{80}{220} = 0.3636$
N4-N6	N1	A	$\frac{100}{280} = 0.3571$
		B	$\frac{40}{280} = 0.1429$
	N3	C	$\frac{80}{280} = 0.2857$
	N4	D (offtake)	$\frac{40}{280} = 0.1429$
		D (injection)	$\frac{20}{280} = 0.0714$

33 De-rating

- (1) This clause 33 applies if both of the following conditions are satisfied:
- (a) a **customer** (the notifying **customer**) has notified **Transpower** in writing that—
 - (i) the notifying **customer's assets** at a **connection location** have been **de-rated**; or
 - (ii) **embedded plant** connected to the notifying **customer's assets** at a **connection location** have been **de-rated** and the **de-rating** is **large**;
 - (b) **Transpower** is reasonably satisfied the notified **de-rating** or **large de-rating** has occurred.
- (2) In this clause 33, a relevant **pricing year** is—
- (a) the first **pricing year** that starts at least 6 months (or such shorter period as **Transpower** may determine is practicable) after the date the conditions in subclause (1) are first satisfied; and
 - (b) a subsequent **pricing year** if the date the conditions in subclause (1) are first satisfied is within **CMP A** for the **pricing year**.
- (3) **Transpower** must, for each relevant **pricing year**, calculate **connection charges** for the **connection location** by—
- (a) estimating the notifying **customer's** future **AMDC** and **AMIC** for the **connection location** taking into account—
 - (i) the reduced **capacity** of the connecting **customer's assets** or the **embedded plant** (as the case may be); and
 - (ii) any available historical information about the notifying **customer's offtake** and **injection** at the **connection location**; and

- (b) capping the notifying **customer's AMDC** and **AMIC** for the **connection location** and relevant **pricing year** at the notifying **customer's** estimated future **AMDC** and **AMIC** for the **connection location**.

34 Replacement Costs

- (1) **Transpower** must review, including update as appropriate, the **replacement costs** it uses to calculate **connection charges** no later than 5 years after the start of the **first pricing year** and, after that, at intervals of no more than 5 years.
- (2) **Transpower's** first review of **replacement costs** under subclause (1) may occur before the start of the **first pricing year**.
- (3) Subject to subclause (4), **Transpower** must consult with all **customers** who pay **connection charges** on any update to **replacement costs** under subclause (1) before updating the **replacement costs**.
- (4) **Transpower** is not required to consult on an update to **replacement costs** under subclause (1) if **Transpower** determines—
 - (a) the update is technical and non-controversial; or
 - (b) there is widespread support for the update among **customers**; or
 - (c) there has been adequate prior consultation on the update so that all relevant views of **customers** have been considered.
- (5) Before **Transpower's** first review of **replacement costs** under subclause (1) is completed, the **replacement cost** of a **connection asset commissioned** before 1 July 2006 is calculated by multiplying the **connection asset's** unadjusted **replacement cost** by the **replacement cost adjustment factor**.
- (6) If **Transpower** does not have a **replacement cost** for a **connection asset**, **Transpower** must use the **replacement cost** available to **Transpower** for the closest equivalent of the **connection asset**, as determined by **Transpower**, for the purposes of calculating **connection charges** for the **connection asset**.

Part D Benefit-based Charges

General

35 Calculation of Benefit-based Charges

- (1) Subject to subclauses 84(7) and 85(6) and clause 88, only **beneficiaries** pay **benefit-based charges**, and only for the **BBIs** of which they are **beneficiaries**.
- (2) A **beneficiary's annual benefit-based charge** for a **BBI** and **pricing year** (**BBC**) is calculated as follows:

$$BBC = CC \times CA$$

where

CC is the **BBI's covered cost** for the **pricing year**

CA is the **beneficiary's BBI customer allocation** for the **BBI**.

- (3) A **beneficiary's monthly benefit-based charge** for a **BBI** and **pricing year** (**MBBC**) is calculated as follows:

$$MBBC = \frac{BBC}{12}$$

where **BBC** is the **beneficiary's annual benefit-based charge** for the **BBI** and **pricing year**.

- (4) **Benefit-based charges** are calculated for each **pricing year** before the start of the **pricing year**.
- (5) A **benefit-based charge** may be—
- adjusted, including during a **pricing year**, under clauses 81 to 91 if there is a **benefit-based charge adjustment event**; and
 - adjusted under clause 96 if the relevant **BBI** is subject to **reassignment**.

36 Start of Benefit-based Charges

Transpower must start the **benefit-based charges** for a **BBI** from the **BBI's start pricing year**. To avoid doubt, this clause does not apply to charges under an **investment agreement**.

Clause 36: replaced, on 31 July 2023, by clause 8 of the Electricity Industry Participation Code Amendment (Transmission Pricing Methodology Amendments) 2023.

37 Expenditure on Existing BBIs

- (1) Subject to subclause (4) and (5), **Transpower** must treat a **refurbishment investment** or **replacement investment** in respect of an existing **post-2019 BBI** as—
- part of the existing **post-2019 BBI**, in which case the **refurbishment investment** or **replacement investment** will increase the **covered cost** of the **post-2019 BBI** but will not change its **BBI customer allocations**; or
 - a separate **post-2019 BBI**; or
 - part of an existing **post-2019 BBI** referred to in paragraph (b), in which case the **refurbishment investment** or **replacement investment** will increase the **covered cost** of the **post-2019 BBI** but will not change its **BBI customer allocations**.

- (2) Subject to subclause (4) and (5), **Transpower** must treat a **refurbishment investment** or **replacement investment commissioned** after 23 July 2019 in respect of an **Appendix A BBI** as—
 - (a) a separate **post-2019 BBI**; or
 - (b) part of an existing **post-2019 BBI** referred to in paragraph (a), in which case the **refurbishment investment** or **replacement investment** will increase the **covered cost** of the **post-2019 BBI** but will not change its **BBI customer allocations**.
- (3) Subject to subclause (5), **Transpower** must treat an **enhancement investment commissioned** after 23 July 2019 in respect of an existing **BBI** as a separate **post-2019 BBI**.
- (4) **Transpower** must not treat a **refurbishment investment** or **replacement investment** as part of an existing **post-2019 BBI** under subclause (1) or (2) if **Transpower** determines the **refurbishment investment** or **replacement investment** is likely to have—
 - (a) different **beneficiaries** than the existing **post-2019 BBI**; or
 - (b) a materially different distribution of **NPB** than the existing **post-2019 BBI**.
- (5) If a **refurbishment investment**, **replacement investment** or **enhancement investment** referred to in subclause(1), (2) or (3) is an **exempt post-2019 investment**—
 - (a) **Transpower** must not treat the **refurbishment investment**, **replacement investment** or **enhancement investment** as, or as part of, a **post-2019 BBI**; and
 - (b) if the **refurbishment investment**, **replacement investment** or **enhancement investment** is in respect of an **Appendix A BBI**, **Transpower** must treat the **refurbishment investment**, **replacement investment** or **enhancement investment** as part of the **Appendix A BBI**, in which case the **refurbishment investment**, **replacement investment** or **enhancement investment** will increase the **covered cost** of the **Appendix A BBI** but will not change its **BBI customer allocations**.

38 Assumptions Book

- (1) **Transpower** must **publish**, and may from time to time **publish** updates to, an **assumptions book**.
- (2) The **assumptions book** must not contain any assumptions or methodologies that are inconsistent with this Code.
- (3) Subject to subclause (4), **Transpower** must consult with all **customers** on the **assumptions book** or any update to it before **publishing** the **assumptions book** or update.
- (4) **Transpower** is not required to consult on an update to the **assumptions book** if **Transpower** determines—
 - (a) the update is technical and non-controversial; or
 - (b) there is widespread support for the update among **customers**; or
 - (c) there has been adequate prior consultation on the update so that all relevant views of **customers** have been considered.
- (5) Except as otherwise stated in this **transmission pricing methodology**, the **assumptions book** is not binding on **Transpower** or any **independent expert**.
- (6) **Transpower** must review the content of the **assumptions book** and consider whether any of the content is appropriate for incorporation in this **transmission pricing methodology** by way of a review under clause 12.85 of this Code no later than 7 years after its date of publication and, after that, at intervals of no more than 7 years.
- (7) The **assumptions book** may be part of the same document in which the **reassignment practice manual** or **prudent discount practice manual** is contained.

Covered Cost

39 Covered Cost

(1) A **BBI's covered cost** for a **pricing year** (CC) is calculated as follows:

$$CC = \sum_a (D_a + C_a + T_a) + AO$$

where

D_a is **depreciation** of asset a for the preceding **financial year**, where asset a is an asset comprised in the **BBI**, excluding **accelerated depreciation**

C_a is the **capital charge** for asset a and the preceding **financial year** calculated under subclause (2)

T_a is the sum of—

- (a) **Transpower's** depreciation tax loss (positive value) or gain (negative value) for asset a and the preceding **financial year** calculated under subclause (3); and
- (b) income tax on the **capital charge** for asset a and the preceding **financial year** calculated under subclause (5)

AO is the attributed opex component for the **BBI** and **pricing year** calculated under subclause 40(1).

(2) The **capital charge** for an asset and **financial year** (C) is calculated—

(a) if the asset had an **opening RAB value** for the **financial year**, as follows:

$$C = r \times V$$

where

r is **Transpower's PQ WACC** (vanilla) at the start of the **financial year**

V is, subject to subclause 7, the **opening RAB value** for the asset and **financial year**; or

(b) if the asset was **commissioned** during the **financial year**, as follows:

$$C = V \times \frac{r \times (12.5 - m)}{12}$$

where

V is, subject to subclause (7), the asset's **value of commissioned asset**

r is **Transpower's PQ WACC** (vanilla) at the start of the **financial year**

m is the month of the **financial year** during which the asset was **commissioned** (for example, $m = 3$ for September).

- (3) **Transpower's** depreciation tax loss or gain for an asset and **financial year** (T_{dep}) is calculated as follow

$$T_{dep} = \frac{r \times (AD - TD - I)}{1 - r}$$

where

r is the corporate tax rate, as defined in the **Transpower IMs**, at the start of the **financial year**

AD is **depreciation** of the asset during the **financial year**, excluding **accelerated depreciation**

TD is tax depreciation of the asset during the **financial year**, excluding **accelerated depreciation**

I is notional interest for the asset and **financial year** calculated under subclause (4).

- (4) Notional interest for an asset and **financial year** (I) is calculated as follows:

$$I = V \times L \times CD$$

where

V is, subject to subclause (7), the **opening RAB value** for the asset and **financial year**

L is leverage, as defined in the **Transpower IMs**, at the start of the **financial year**

CD is the estimated cost of debt used under the **Transpower IMs** to calculate **Transpower's PQ WACC** (vanilla) applicable at the start of the **financial year**.

- (5) Income tax on the **capital charge** for an asset and **financial year** (T_{inc}) is calculated as follows:

$$T_{inc} = \frac{r \times C}{1 - r}$$

where

r is the corporate tax rate, as defined in the **Transpower IMs**, at the start of the **financial year**

C is the **capital charge** for the asset and **financial year** calculated under subclause (2).

- (6) *[Revoked]*

- (7) If the asset referred to in subclause (2) or (4)—
- (a) has been **written-down**; and
 - (b) is comprised in a **BBI** that, as at the start of the relevant **financial year**, does not meet the requirements of subparagraph (b)(i), (b)(ii) or (b)(iii) of the definition of **eligible BBI** in clause 3; and
 - (c) the circumstances justifying the **write-down** of the asset would otherwise justify **reassignment** of the **BBI** (excluding subparagraph 104(2)(b)(ii)),
- Transpower** must carry out the calculation under subclause (2) or (4) for the asset as if the asset had not been **written-down**.

- (8) This clause 39 is subject to clause 40A.
Clause 39(1) and (3): amended, on 31 July 2023, by clause 9(1) of the Electricity Industry Participation Code Amendment (Transmission Pricing Methodology Amendments) 2023.
Clause 39(6): revoked, on 31 July 2023, by clause 9(2) of the Electricity Industry Participation Code Amendment (Transmission Pricing Methodology Amendments) 2023.
Clause 39(8): inserted, on 31 July 2023, by clause 9(3) of the Electricity Industry Participation Code Amendment (Transmission Pricing Methodology Amendments) 2023.

40 Attributed Opex Component

- (1) The attributed opex component for a **BBI** and **pricing year** (AO) is calculated as follows:

$$AO = \sum_a (D_a \times AOR) + HVDC + TA + MCP$$

where

D_a is **depreciation** of asset a for the preceding **financial year**, where asset a is an asset comprised in the **BBI**, excluding **accelerated depreciation**

AOR is the attributed opex ratio for the **pricing year** calculated under subclause (3)

HVDC is—

- (a) if the **BBI** comprises 1 or more **transmission investments** in the **HVDC link**, an allocation of **HVDC opex** for the preceding **financial year** as determined by **Transpower** subject to subclause (2); or
- (b) otherwise, 0

TA is—

- (a) if the **BBI** comprises 1 or more **interconnection transmission alternatives**, **TA opex** for the **interconnection transmission alternatives** and preceding **financial year**, less any contribution to the **TA opex** under **investment agreements**; or
- (b) otherwise, 0

MCP is **MCP opex** for the **BBI** and preceding **financial year**.

- (2) **HVDC opex** for a **financial year** must be fully allocated to 1 or more **BBI**s that comprise a **transmission investment** in the **HVDC link**, unless there are no such **BBI**s.
- (3) The attributed opex ratio for a **pricing year** during an **RCP** (AOR) is calculated as follows:

$$AOR = \frac{OC + PC + RC - HVDC - TA - MCP - FD}{D}$$

where

OC is the **allowance** for operating costs, as defined in the **Transpower IMs**, for the **RCP**

PC is the **allowance** for pass-through costs, as defined in the **Transpower IMs**, for the **RCP**

RC is the **allowance** for recoverable costs, as defined in the **Transpower IMs**, for the **RCP**

HVDC is forecast **HVDC opex** for the **RCP**

TA is the **allowance** for **TA opex** for the **RCP**, to the extent it is included in any of the above **allowances**

MCP is the **allowance** for **MCP opex** for the **RCP**, to the extent it is included in any of the above **allowances**

FD is an amount of operating costs attributable to **Transpower** assets that are fully depreciated at the start of the **RCP**, as determined by **Transpower**

D is the **allowance** for **depreciation** for the **RCP**.

- (4) The value of AOR in subclause (3) is—
- calculated for the whole of the **RCP**; and
 - only re-calculated if any of the relevant **allowances** are reset by the **Commission** during the **RCP**.

- (5) This clause 40 is subject to clause 40A.

Clause 40(1): amended, on 31 July 2023, by clause 10(1) of the Electricity Industry Participation Code Amendment (Transmission Pricing Methodology Amendments) 2023.

Clause 40(5): inserted, on 31 July 2023, by clause 10(2) of the Electricity Industry Participation Code Amendment (Transmission Pricing Methodology Amendments) 2023.

40A Commissioned Assets Not Asseted

An asset that—

- is comprised in a **BBI**; and
- was **commissioned** at or before the end of the **financial year** preceding the **pricing year** for which **Transpower** is calculating the **BBI's covered cost**; and
- is not **asseted** at the time of that calculation,

must be ignored for the purposes of calculating the **BBI's covered cost** for the **pricing year**.

Clause 40A: inserted, on 31 July 2023, by clause 11 of the Electricity Industry Participation Code Amendment (Transmission Pricing Methodology Amendments) 2023.

41 Covered Cost of Anticipatory BBI

To avoid doubt, clauses 39 and 40 do not apply to an **anticipatory BBI**, the deemed **covered cost** of which is calculated under paragraph 27(2)(b).

BBI Customer Allocations

42 BBI Customer Allocations for Appendix A BBIs

- (1) Subject to paragraph 75(5)(a), for each **Appendix A BBI**—
- (a) the starting **beneficiaries** are the **Appendix A beneficiaries** for the **Appendix A BBI**; and
 - (b) the starting **BBI customer allocations** are the **Appendix A allocations** for the **Appendix A BBI**.
- (2) To avoid doubt, for each **Appendix A BBI**—
- (a) the **Appendix A beneficiaries** are based on the **Schedule 1 beneficiaries** of the **Appendix A BBI**; and
 - (b) the **Appendix A allocations** are based on the **Schedule 1 allocations** for the **Appendix A BBI**,

in each case adjusted as **Transpower** determined necessary to account for changes to and affecting **customers** before and after the **Authority** published the **2020 guidelines**.

43 BBI Customer Allocations for Post-2019 BBIs

- (1) A **customer's BBI customer allocation** for a **post-2019 BBI** (CA) is calculated as follows:

$$CA = \frac{NPB}{NPB_{total}}$$

where

NPB is the **customer's individual NPB** for the **post-2019 BBI**

NPB_{total} is the total of all **customers' individual NPBs** for the **post-2019 BBI**.

- (2) Subject to subclauses (3) and (4A), a **customer's individual NPB** for a **post-2019 BBI** is calculated under a **standard method** or the **simple method** as follows:

type	sub-type	method
post-2019 BBI expected to be high-value when fully commissioned	resiliency BBI	resiliency method
	otherwise	price-quantity method
post-2019 BBI expected to be low-value when fully commissioned	none	simple method

- (2A) If **Transpower's** expectation as to whether a **post-2019 BBI** will be **high-value** or **low-value** when **fully commissioned** changes before—

- (a) the **post-2019 BBI's final investment decision date**; or
- (b) for a **post-2019 BBI** with a **final investment decision date** before the start of the **first pricing year**, the date the **post-2019 BBI** is **commissioned**,

Transpower may, but is not obliged to, change the method it applies to calculate **customers' BBI customer allocations** for the **post-2019 BBI** from a **standard method** to the **simple method** or vice versa in accordance with subclause (2). However, **Transpower** must not change the method if **Transpower** has already notified one or more **customers** of their **benefit-**

based charges for the **post-2019 BBI** and its **start pricing year** under their **transmission agreements**.

- (3) For the purpose of calculating **customers' BBI customer allocations** for a **high-value intervening BBI** and its **start pricing year**, **Transpower** may apply the **simple method** if **Transpower** determines it is necessary to do so to ensure there is sufficient time for **Transpower** to complete a robust process for calculating the **BBI's BBI customer allocations** under the **standard method**, including consultation under clause 15.
- (4) If **Transpower** applies the **simple method** under subclause (3) for a **high-value intervening BBI**, **Transpower** must carry out a wash-up of **transmission charges** in the **pricing year** after the **BBI's start pricing year** so that no **customer** is under or over-charged **benefit-based charges** for the **BBI** and **start pricing year** as a result of **Transpower** applying the **simple method** under subclause (3). The wash-up must include time value of money adjustments using **Transpower's ID WACC** (pre-tax).
- (4A) If **Transpower**—
- (a) expects a **post-2019 BBI** to be **high-value** when **fully commissioned**; and
 - (b) expects one or more **interconnection investments** comprised in the **post-2019 BBI** to become **connection investments** within 3 years of the **post-2019 BBI's full commissioning date**; and
 - (c) would not expect the **post-2019 BBI** to be **high-value** when **fully commissioned** if those **interconnection investments** were excluded from the **post-2019 BBI** on its **full commissioning date**,
- Transpower** must apply the **simple method** to calculate **customers' BBI customer allocations** for the **post-2019 BBI**.
- (5) If a **post-2019 BBI** is a **tested investment**, the assumptions and other inputs (including the **factual, counterfactual, modelled constraints and scenarios**) **Transpower** uses in applying a **standard method** to the **post-2019 BBI** must be as consistent as reasonably practicable with the assumptions and other inputs used in applying the **investment test** to the **post-2019 BBI**, except—
- (a) as otherwise stated in this **transmission pricing methodology**; or
 - (b) to the extent **Transpower** determines such alignment would not produce **BBI customer allocations** that are broadly proportionate to positive **NPB** from the **post-2019 BBI**, in which case **Transpower** may use different assumptions and other inputs provided they do not contradict what **Transpower** determines were its key drivers for proceeding with its investment in the **post-2019 BBI** as at the **post-2019 BBI's final investment decision date**.
- (6) To avoid doubt, the order of the provisions of this **transmission pricing methodology** specifying the **standard methods** and **simple method** do not necessarily reflect the order in which **Transpower** will carry out the steps specified in those provisions when **Transpower** applies the relevant **standard method** or **simple method**.

Clause 43(2): amended, on 31 July 2023, by clause 12(1) of the Electricity Industry Participation Code Amendment (Transmission Pricing Methodology Amendments) 2023.

Clause 43(2A): inserted, on 31 July 2023, by clause 12(2) of the Electricity Industry Participation Code Amendment (Transmission Pricing Methodology Amendments) 2023.

Clause 43(4A): inserted, on 31 July 2023, by clause 12(3) of the Electricity Industry Participation Code Amendment (Transmission Pricing Methodology Amendments) 2023.

Standard Method: Price-quantity Method

44 Overview of Price-quantity Method

- (1) Clauses 44 to 55 apply—
 - (a) to the **price-quantity method** only; and
 - (b) only to those **post-2019 BBIs** to which **Transpower** applies the **price-quantity method** in accordance with subclause 43(2).

- (2) Under the **price-quantity method**—
 - (a) **regional NPB** is calculated for a **regional customer group** as any of the following:
 - (i) **market regional NPB** under clauses 49 to 52
 - (ii) **ancillary service regional NPB** under clause 53;
 - (iii) **reliability regional NPB** under clause 54;
 - (iv) **other regional NPB** under clause 55; and
 - (b) subject to subclauses (3) and 55(2), **Transpower** may—
 - (i) calculate **market regional NPB** for a **market BBI**; and
 - (ii) calculate **ancillary service regional NPB** for an **ancillary service BBI**; and
 - (iii) calculate **reliability regional NPB** for a **reliability BBI**; and
 - (iv) calculate or estimate **other regional NPB** for a **market BBI, ancillary service BBI or reliability BBI**; and
 - (c) **individual NPB** is calculated for each **customer** in a **regional customer group** with positive **regional NPB**.

Clause 44(2)(b): replaced, on 1 March 2024, by clause 4(1) of the Electricity Industry Participation Code Amendment (Transmission Pricing Methodology Amendments) (No 2) 2023.

- (3) Under the **price-quantity method**, **Transpower** must—
 - (a) always calculate at least 1 of **market regional NPB, ancillary service regional NPB or reliability regional NPB** for a **post-2019 BBI**; and
 - (ab) calculate **market regional NPB** for a **market BBI** if **Transpower** determines it is necessary to do so to produce **BBI customer allocations** for the **market BBI** that are broadly proportionate to positive **NPB** from the **market BBI**; and
 - (b) calculate **ancillary service regional NPB** for an **ancillary service BBI** if **Transpower** determines it is necessary to do so to produce **BBI customer allocations** for the **ancillary service BBI** that are broadly proportionate to positive **NPB** from the **ancillary service BBI**; and
 - (c) calculate **reliability regional NPB** for a **reliability BBI** if **Transpower** determines it is necessary to do so to produce **BBI customer allocations** for the **reliability BBI** that are broadly proportionate to positive **NPB** from the **reliability BBI**.

Clause 44(3)(ab): inserted, on 1 March 2024, by clause 4(2) of the Electricity Industry Participation Code Amendment (Transmission Pricing Methodology Amendments) 2024.

45 Factual and Counterfactual

- (1) **Transpower** must determine a **BBI's factual and counterfactual**.

- (2) **Transpower** must apply the following principles to determine the **BBI's counterfactual** unless **Transpower** determines applying these principles does not produce a reasonably likely future **grid state**:
 - (a) if a **transmission investment** comprised in the **BBI** is an **enhancement investment**, the **counterfactual** must include the **transmission investment** not being made;
 - (b) if a **transmission investment** comprised in the **BBI** is a **replacement investment or compliance investment**, the **counterfactual** must include the immediate

decommissioning of the relevant **grid asset** or **transmission alternative** without replacement:

- (c) if a **transmission investment** comprised in the **BBI** is a **refurbishment investment**, the **counterfactual** must include leaving the relevant **grid asset** or **transmission alternative** in operation without refurbishment until it reaches replacement state and then immediately decommissioning it without replacement.

46 Scenarios

- (1) **Transpower** must determine a **BBI's scenarios** and probability weightings for the **scenarios**. A **market BBI's market scenarios** must include variations in load growth, generation expansion and hydrology.
- (2) **Transpower** must apply the same **scenarios** in a **BBI's factual** and **counterfactual**, unless the **BBI** is a **market BBI** that is expected to influence materially **generating plant** investment decisions, in which case **Transpower** may apply different generation expansion **market scenarios** in the **BBI's factual** and **counterfactual**.
- (3) If a **market scenario** for a **BBI** includes a **customer** ceasing to be a **customer**, the **market scenario** must not be applied in the **BBI's factual or counterfactual** in respect of the **customer**. To avoid doubt, this means the present value of **regional NPB** for a **regional customer group** for the **BBI** of which the **customer** is a member may be different for the **customer** than for all other **customers** who are members of the **regional customer group**.

47 Individual NPB

A **customer's individual NPB** for a **BBI** (NPB) is calculated as follows:

$$NPB = \sum_g \left(PVRNPB_g \times \frac{IRA_g}{IRA_{g \text{ total}}} \right)$$

where

$PVRNPB_g$ is the present value of **regional NPB** for **regional customer group g** calculated under clause 48, where **regional customer group g** is a **regional customer group** for the **BBI**—

- (a) that has a positive present value of **regional NPB**; and
(b) of which the **customer** is a member

IRA_g is the value of the **customer's intra-regional allocator** for **regional customer group g**

$IRA_{g \text{ total}}$ is the total of the values of all **customers' intra-regional allocators** for **regional customer group g**.

48 Present Value of Regional NPB

- (1) Subject to subclause (2), the present value of a **regional customer group's regional NPB** (PVRNPB) is calculated as follows:

$$PVRNPB = \sum_n \frac{RNPB_n}{(1+r)^n}$$

where

$RNPB_n$ is the **regional customer group's market regional NPB, ancillary service regional NPB, reliability regional NPB or other regional NPB** (as the case may be) for year n of the **BBI's standard method calculation period**

r is the **BBI's standard method rate**.

- (2) As an alternative to the calculation under subclause (1), **Transpower** may calculate a **regional customer group's market regional NPB, ancillary service regional NPB, reliability regional NPB or other regional NPB** (as the case may be) for each year of the **BBI's standard method calculation period** on a present value basis, provided that the method of calculating present value is consistent with the method in subclause (1).

49 Modelling for Market Regional NPB

- (1) This clause 49 applies to modelling for calculating **market regional NPB** for a **market BBI**.
- (2) **Transpower** must determine the **market BBI's investment grids**.
- (3) **Transpower** must use a **wholesale market model** to model the prices, quantities and changes in prices and quantities in the **wholesale market** for **electricity** between the **market BBI's factual and counterfactual** under its **market scenarios** and based on its **investment grids**. The modelling must cover each year of the **market BBI's standard method calculation period**.
- (4) The illustrative **wholesale market models** in figures 11 and 12 below show alternative modelled prices, quantities and changes in prices and quantities for a notional **market BBI, market scenario** and year of the **market BBI's standard method calculation period** (assuming no adjustments under subclause (6)). The effect of the **market BBI** is modelled as a change in the supply curve from S (**counterfactual**) to S' (**factual**). P_{max} is **consumers' estimated cost of self-supply for electricity or alternative energy**.

Figure 11

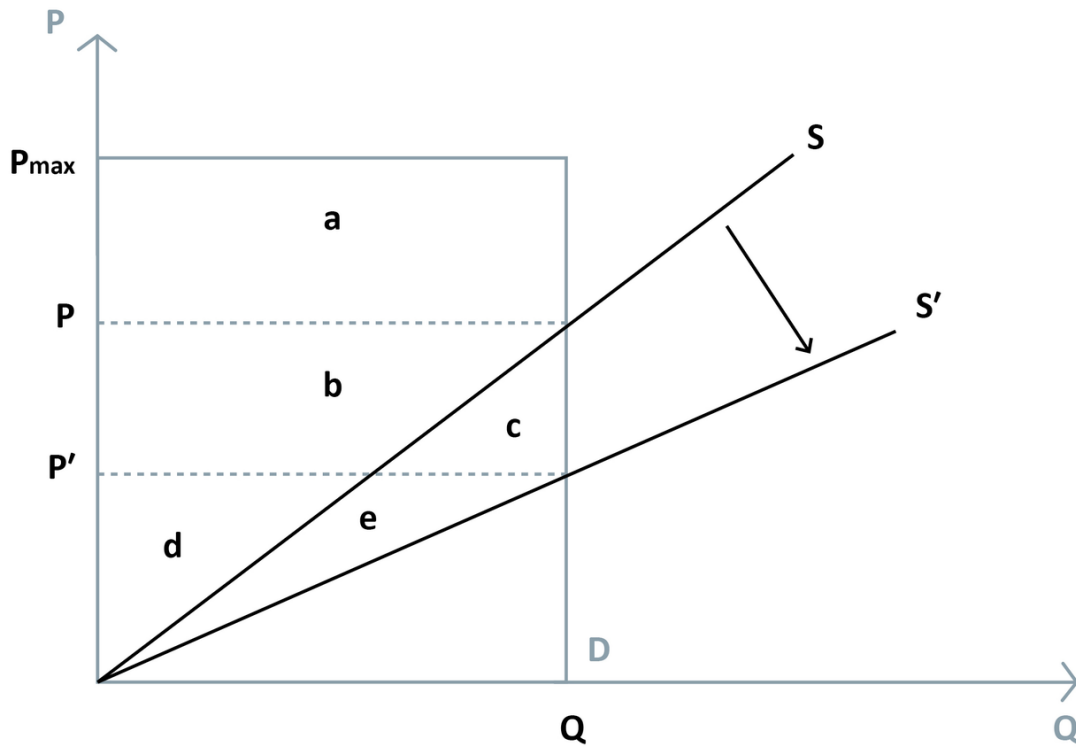
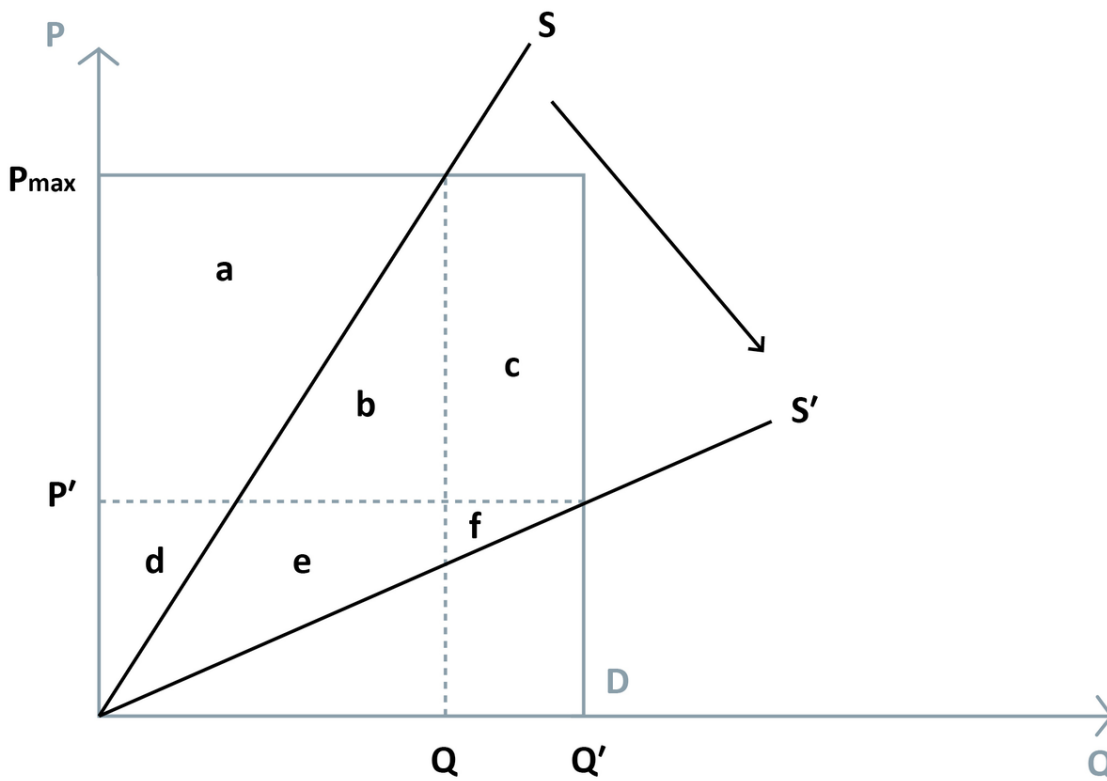

Figure 12



- (5) In carrying out the modelling under this clause 49, **Transpower** may model **embedded plant** as if it were **grid-connected**. If **Transpower** does this, the modelled market benefits and

disbenefits in respect of the **plant** must be attributed to the relevant **host customer**, not the owner of the **plant**.

- (6) **Transpower** may adjust prices in the modelling under this clause 49 if, and to the extent, **Transpower** determines it is appropriate to do so to moderate the sensitivity of modelled prices and changes in prices to modelling assumptions and other inputs, or otherwise with the objective of ensuring the **BBI customer allocations** for the **market BBI** are broadly proportionate to positive **NPB** from the **market BBI**.

50 Modelled Regions and Regional Customer Groups

- (1) **Transpower** must determine the **market BBI's modelled regions** as follows and based on the outcomes of the modelling under clause 49:

(aa) **Transpower** must determine the **market BBI's modelled regions** based on the outcomes of the modelling under clause 49 except to the extent **Transpower** determines basing the **modelled regions** on those outcomes would not support the objective in paragraph (d):

- (a) a **modelled region** must be a set of either **GXPs** or **GIPs**:
- (b) the expected price or quantity changes, if any, at all **GXPs** or **GIPs** in a **modelled region** must be in the same direction:
- (c) a region meeting the requirements of paragraphs (a) and (b) may comprise more than 1 **modelled region** if the market benefits or disbenefits accruing at different **GXPs** or **GIPs** in the region—
 - (i) are of a materially different magnitude; or
 - (ii) occur at different times, or are of a materially different magnitude, depending on whether there are binding **constraints**; or
 - (iii) occur under different **market scenarios**:

(d) **Transpower** must determine the **market BBI's modelled regions** with the objective of ensuring the **BBI customer allocations** for the **market BBI** are broadly proportionate to positive **NPB** from the **market BBI**.

- (2) **Transpower** must determine the **market BBI's regional customer groups** as follows and based on the outcomes of the modelling under clause 49:

(a) subject to paragraph (b) and subclauses 51(7) and 52(9), the **market BBI's regional customer groups** are as follows:

type of regional customer group	modelled region	regional customer group
regional demand group	a region defined by a set of GXPs	subject to subclause (4), all offtake customers in the modelled region
regional supply group	a region defined by a set of GIPs	all injection customers in the modelled region

- (b) there may be more than 1 **regional demand group** or **regional supply group** for the same **modelled region**, each comprising different **offtake customers** or **injection customers** (as the case may be), if **Transpower** determines it is necessary to have more than 1 **regional demand group** or **regional supply group** for the **modelled region** to produce **BBI customer allocations** for the **market BBI** that are broadly proportionate to positive **NPB** from the **market BBI**, having regard to the attributes of the **offtake**

customers or injection customers (including whether the **offtake customers or injection customers** currently exist in the **modelled region**).

- (3) To avoid doubt—
- (a) the **market BBI** may have 1 or more **future regional customer groups**, which may be **regional demand groups, regional supply groups** or a combination of both; and
 - (b) a **regional customer group** that is not a **future regional customer group** may, in future, include **offtake customers or injection customers** who do not currently exist in the relevant **modelled region**.
- (4) An **offtake customer** is not a member of a **regional demand group** for the **market BBI** in respect of its **grid-connected battery storage** if the **market BBI's market regional NPB** is calculated under clause 52.
- Clause 50(1)(aa): inserted, on 1 March 2024, by clause 5(1) of the Electricity Industry Participation Code Amendment (Transmission Pricing Methodology Amendments) 2024.
Clause 50(1)(b): amended, on 1 March 2024, by clause 5(2) of the Electricity Industry Participation Code Amendment (Transmission Pricing Methodology Amendments) 2024.

51 Calculation of Market Regional NPB based on Quantity

- (1) **Transpower** must calculate **market regional NPB** for a **market BBI** under this clause 51 if—
- (a) **Transpower** determines, based on the outcomes of the modelling under clause 49 and taking into account the **market BBI's market scenarios** and their probability weightings determined by **Transpower** under clause 46(1), that most of the positive **market regional NPB** for the **market BBI's regional supply groups** relates to new **large generating plant** for which, at the time **Transpower** makes its determination under this paragraph, the proponent has not made its final decision to proceed with its investment in the **plant**; or
 - (b) subclause 52(1) does not apply.
- (2) To avoid doubt, paragraph (1)(a) does not require **Transpower** to have determined the **market BBI's regional supply groups** before making the determination under that paragraph.
- (3) For each **regional customer group, market scenario** and year of the **market BBI's standard method calculation period**, the expected market benefit (positive value) or disbenefit (negative value) is calculated based on—
- (a) the modelling under clause 49; and
 - (b) the period or periods during which the **market BBI** is modelled to generate its primary market benefits, as determined by **Transpower** (the **periods of benefit**), as follows:
 - (c) for a **regional demand group**, quantities in the **counterfactual** are positive if there are **alleviated prices** for the **regional demand group** during the **periods of benefit** and negative if there are **exacerbated prices** for the **regional demand group** during the **periods of benefit**;
 - (d) for a **regional supply group**, quantities in the **counterfactual** are positive if there are **exacerbated prices** for the **regional supply group** during the **periods of benefit** and negative if there are **alleviated prices** for the **regional supply group** during the **periods of benefit**;
 - (e) subject to subclause (4), for a **regional demand group or regional supply group**, the positive or negative quantities under paragraph (c) or (d) (as appropriate) are summed with the changes in quantities between the **factual** and **counterfactual** during all periods,

an increase being positive and a decrease being negative, the sum being the expected market benefit or disbenefit.

- (4) In applying paragraph (3)(e), **Transpower** must adjust the changes in quantities as it determines necessary to ensure the market benefit or disbenefit attributable to modelled changes in **injection** and **offtake** for **grid-connected battery storage** is not double-counted.
- (5) To avoid doubt, any **alleviated prices** or **exacerbated prices** outside the **periods of benefit** are ignored when applying paragraphs (3)(c) and (3)(d).
- (6) Subject to subclause (7), a **regional customer group's market regional NPB** for a year of the **market BBI's standard method calculation period** (MRNPB) is calculated as follows:

$$MRNPB = \frac{1}{\sum_s W_s} \sum_s (EMBD_s \times W_s)$$

where

$EMBD_s$ is the expected market benefit (positive value) or disbenefit (negative value) for the **regional customer group** and year for **market scenario s**, where **market scenario s** is a **market scenario** for the **market BBI**, but excluding any expected market benefit or disbenefit attributable to a future **customer** or future **large plant** unless the **regional customer group** is a **future regional customer group**

W_s is the probability weighting for **market scenario s** determined by **Transpower** under clause 46(1).

- (7) If a **customer** has **injection** and **offtake** at the same **connection location**, **Transpower** may, in carrying out the calculation under subclause (6), set off the **customer's** expected market disbenefit from its **injection** or **offtake** at the **connection location** against the **customer's** expected market benefit from its **offtake** or **injection** at the **connection location**. If **Transpower** does this, **Transpower** must assign the **customer** and the **customer's** net expected market benefit to either the **regional demand group** or **regional supply group** for the **modelled region** in which the **connection location** is located (but not to both) depending on the **regional customer group** for which the **customer** has the higher present value net expected market benefit over the **market BBI's standard method calculation period** (each present value calculated consistently with clause 48).
- (8) To avoid doubt, subject to subclause (7), expected market benefits and disbenefits are not summed between different **regional customer groups**.
- (9) If necessary for calculating the **BBI customer allocations** for the **market BBI**, **Transpower** must determine the dollar value of each **regional customer group's market regional NPB** for each year of the **market BBI's standard method calculation period**.
Clause 51(9): amended, on 1 March 2024, by clause 6 of the Electricity Industry Participation Code Amendment (Transmission Pricing Methodology Amendments) 2024.

52 Calculation of Market Regional NPB based on Price and Quantity

- (1) **Transpower** must calculate **market regional NPB** for the **market BBI** under this clause 52 if—
 - (a) paragraph 51(1)(a) does not apply; and

- (b) **Transpower** determines, based on the outcomes of the modelling under clause 49 and taking into account the **market BBI's market scenarios** and their probability weightings determined by **Transpower** under clause 46(1), that—
- (i) most of the positive **market regional NPB** for the **market BBI's regional customer groups** derives from **consumers** avoiding having to pay their estimated cost of self-supply for **electricity** or alternative energy during peak **demand** periods; or
 - (ii) calculating **market regional NPB** for the **market BBI** under clause 51 would not produce **BBI customer allocations** that are broadly proportionate to positive **NPB** from the **market BBI**.
- (2) To avoid doubt, subparagraph (1)(b)(i) does not require **Transpower** to have determined the **market BBI's regional customer groups** before making the determination under that subparagraph.
- (3) For a **regional demand group, market scenario** and year of the **market BBI's standard method calculation period**, the expected market benefit or disbenefit is equal to—
- (a) the modelled change in consumer benefit for the **regional demand group** in the **wholesale market for electricity** (a positive change being a market benefit and a negative change being a market disbenefit); plus
 - (b) the modelled change in **loss and constraint excess** received by **customers** in the **regional demand group** as a result of the change in consumer benefit other than through the settlement of **FTRs** (a positive change being a market benefit and a negative change being a market disbenefit), unless—
 - (i) **Transpower** has adjusted modelled price outcomes under subclause 49(6); or
 - (ii) the **market BBI** is a **high-value intervening BBI**.
- (4) For a **regional supply group, market scenario** and year of the **market BBI's standard method calculation period**, the expected market benefit or disbenefit arising is equal to—
- (a) the modelled change in producer benefit for the **regional supply group** in the **wholesale market for electricity** (a positive change being a market benefit and a negative change being a market disbenefit); plus
 - (b) the modelled change in **loss and constraint excess** received by **customers** in the **regional supply group** as a result of the change in producer benefit other than through the settlement of **FTRs** (a positive change being a market benefit and a negative change being a market disbenefit), unless—
 - (i) **Transpower** has adjusted modelled price outcomes under subclause 49(6); or
 - (ii) the **market BBI** is a **high-value intervening BBI**.
- (5) In applying paragraph (4)(a), **Transpower** must model **offtake** of **grid-connected battery storage** as a production cost for **injection** from the **grid-connected battery storage**.
- (6) In the illustrative **wholesale market model** in figure 11 above—
- (a) the expected market benefit or disbenefit for the **regional demand group** is equal to the modelled change in consumer benefit, being:

factual	counterfactual	change in consumer benefit
a + b + c	a	b + c

- (b) the expected market benefit or disbenefit for the **regional supply group** is equal to the modelled change in producer benefit, being:

factual	counterfactual	change in producer benefit
d + e	b + d	e - b

- (7) In the illustrative **wholesale market model** in figure 12 above—

- (a) the expected market benefit or disbenefit for the **regional demand group** is equal to the modelled change in consumer benefit, being:

factual	counterfactual	change in consumer benefit
a + b + c	0	a + b + c

- (b) the expected market benefit or disbenefit for the **regional supply group** is equal to the modelled change in producer benefit, being:

factual	counterfactual	change in producer benefit
d + e + f	a + d	e + f - a

- (8) Subject to subclause (9), a **regional customer group's market regional NPB** for a year of the **market BBI's standard method calculation period** (MRNPB) is calculated as follows:

$$MRNPB = \frac{1}{\sum_s W_s} \sum_s (EMBD_s \times W_s)$$

where

$EMBD_s$ is the expected market benefit (positive value) or disbenefit (negative value) for the **regional customer group** and year for **market scenario s**, where **market scenario s** is a **market scenario** for the **market BBI**, but excluding any expected market benefit or disbenefit attributable to a future **customer** or future **large plant** unless the **regional customer group** is a **future regional customer group**

W_s is the probability weighting for **market scenario s** determined by **Transpower** under clause 46(1).

- (9) If a **customer** has **injection** and **oftake** at the same **connection location**, **Transpower** may, in carrying out the calculation under subclause (8), set off the **customer's** expected market disbenefit from its **injection** or **oftake** at the **connection location** against the **customer's** expected market benefit from its **oftake** or **injection** at the **connection location**. If **Transpower** does this, **Transpower** must assign the **customer** and the **customer's** net expected market benefit to either the **regional demand group** or **regional supply group** for the **modelled region** in which the **connection location** is located (but not to both) depending on the **regional customer group** for which the **customer** has the higher present value net expected

market benefit over the **market BBI's standard method calculation period** (each present value calculated consistently with clause 48).

- (10) To avoid doubt, subject to subclause (9), expected market benefits and disbenefits are not summed between different **regional customer groups**.

53 Ancillary Service Regional NPB

- (1) This clause 53 applies to calculating **ancillary service regional NPB** for an **ancillary service BBI** (if **Transpower** decides to calculate **ancillary service regional NPB** for the **ancillary service BBI**).
- (2) **Transpower** must model changes in prices and quantities in the **wholesale market** for the relevant **specified ancillary service** between the **ancillary service BBI's factual and counterfactual** under its **market scenarios**. The modelling must cover each year of the **ancillary service BBI's standard method calculation period**.
- (3) **Transpower** must determine the **ancillary service BBI's modelled regions and regional customer groups** as follows:

specified ancillary service	type of regional customer group	modelled region	regional customer group
instantaneous reserve (by island)	regional demand group	none	none
	regional supply group	island	all grid-connected generators in the modelled region except in respect of generating plant with capacity equal to or less than the value of INJ_D in clause 8.59 of this Code
frequency keeping	regional demand group	New Zealand	all direct consumers in the modelled region
	regional supply group	none	none
voltage support (by zone)	regional supply group	none	none
	regional demand group	zone	all connected asset owners in the modelled region

- (4) To avoid doubt—
- (a) the **ancillary service BBI** may have 1 or more **future regional customer groups**, which may be **regional demand groups, regional supply groups** or a combination of both; and

- (b) a **regional customer group** that is not a **future regional customer group** may, in future, include **grid-connected generators, direct consumers** or **connected asset owners** who do not currently exist in the relevant **modelled region**.
- (5) For a **regional customer group, market scenario** and year of the **ancillary service BBI's standard method calculation period**, the expected market benefit or disbenefit is equal to the modelled change in the **allocable cost** of the **specified ancillary service** (a negative change being a market benefit and a positive change being a market disbenefit).
- (6) A **regional customer group's ancillary service regional NPB** for a year of the **ancillary service BBI's standard method calculation period** (ASRNPB) is calculated as follows:

$$ASRNPB = \frac{1}{\sum_s W_s} \sum_s (EASBD_s \times W_s)$$

where

$EASBD_s$ is the expected market benefit (positive value) or disbenefit (negative value) for the **regional customer group** and year for **market scenario s**, where **market scenario s** is a **market scenario** for the **ancillary service BBI**, but excluding any expected market benefit or disbenefit attributable to a future **customer** or future **large plant** unless the **regional customer group** is a **future regional customer group**

W_s is the probability weighting for **market scenario s** determined by **Transpower** under clause 46(1).

- (7) To avoid doubt, expected market benefits and disbenefits are not summed between different **regional customer groups**.

54 Reliability Regional NPB

- (1) This clause 54 applies to calculating **reliability regional NPB** for a **reliability BBI** (if **Transpower** decides to calculate **reliability regional NPB** for the **reliability BBI**).
- (2) **Transpower** must use a **system limit model** to model changes in expected **curtailed energy** between the **reliability BBI's factual** and **counterfactual** under its **outage scenarios**. The modelling must cover each year of the **reliability BBI's standard method calculation period**.
- (3) The illustrative **system limit model** in figure 13 below shows, for a notional **reliability BBI, outage scenario, market scenario** and year of the **reliability BBI's standard method calculation period**, the effect of the **reliability BBI**. The effect of the **reliability BBI** is modelled as a change in the **system limit** from S (**counterfactual**) to S' (**factual**), which reduces the value of X (percentage of year t **supply, demand** or **active power** transfer is at or more than the **system limit**). The modelled change in expected **curtailed energy** for the year (ΔECE_z) is calculated as follows:

$$\Delta ECE_z = CE \times P_z \times \Delta P_x$$

where

CE is **Transpower's** estimate of **curtailed energy** caused by the **outage scenario** occurring in the **market scenario**

P_z is **Transpower's** estimate of the probability of the **outage scenario** occurring during the year

ΔP_x is the change in the value of X in figure 13 between the **counterfactual** and **factual**.

Figure 13

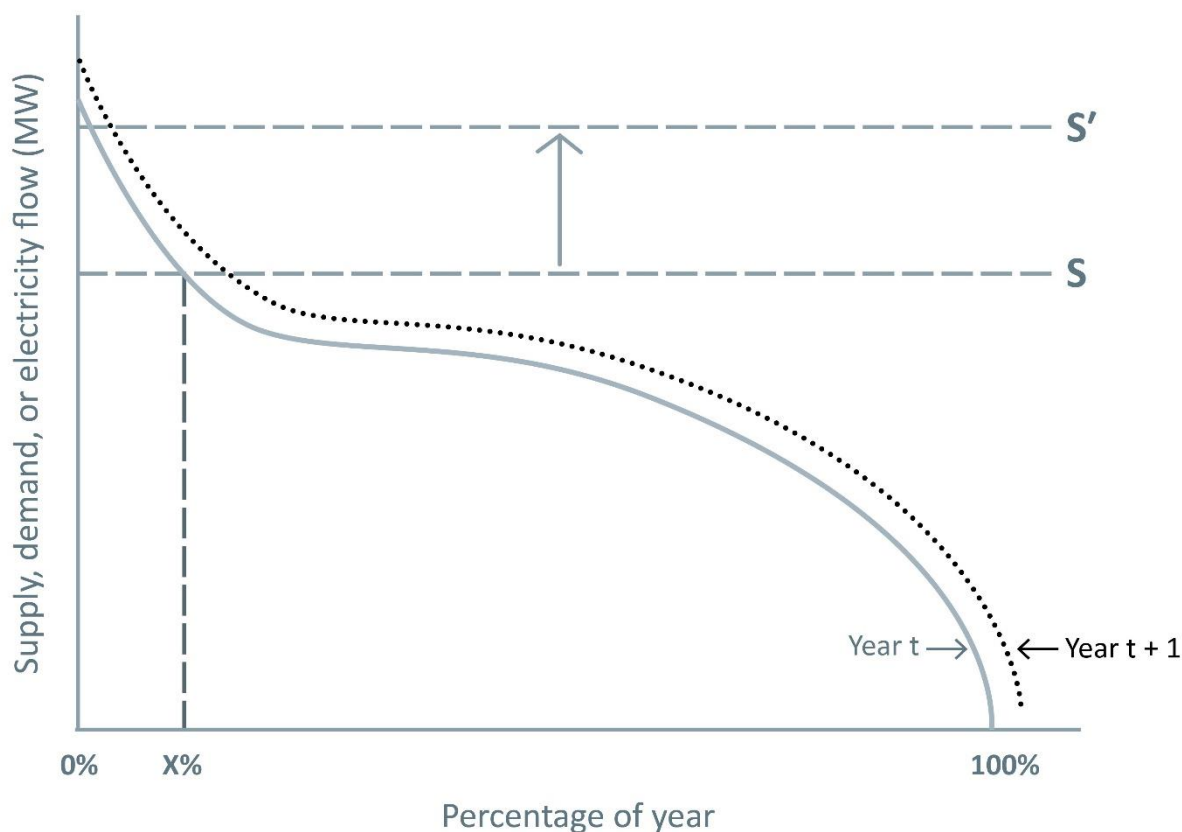

- (4) **Transpower** must determine the **reliability BBI's modelled regions** and **regional customer groups** as follows and based on the outcomes of the modelling under subclause (2):
- (a) subject to paragraph (b), the **reliability BBI's modelled regions** and **regional customer groups** are as follows:

type of regional customer group	modelled region	regional customer group
regional demand group	a region defined by a set of GXPs at which there is expected to be a change in unserved energy in the same direction if an outage scenario for the reliability BBI occurs	all offtake customers in the modelled region except in respect of grid-connected battery storage
regional supply group	a region defined by a set of GIPs at which there is expected to be a change in unsupplied energy in the same direction if an outage scenario for the reliability BBI occurs	all injection customers in the modelled region

- (b) there may be more than 1 **regional demand group** or **regional supply group** for the same **modelled region**, each comprising different **offtake customers** or **injection customers** (as the case may be), if **Transpower** determines it is necessary to have more than 1 **regional demand group** or **regional supply group** for the **modelled region** to produce **BBI customer allocations** for the **reliability BBI** that are broadly proportionate to positive **NPB** from the **reliability BBI**, having regard to the attributes of the **offtake customers** or **injection customers** (including whether the **offtake customers** or **injection customers** currently exist in the **modelled region**).
- (5) To avoid doubt—
- (a) the **reliability BBI** may have 1 or more **future regional customer groups**, which may be **regional demand groups**, **regional supply groups** or a combination of both; and
- (b) a **regional customer group** that is not a **future regional customer group** may, in future, include **offtake customers** or **injection customers** who do not currently exist in the relevant **modelled region**.
- (6) For each **regional customer group**, **market scenario** and year of the **reliability BBI's standard method calculation period**, the expected reliability benefit or disbenefit (ERBD) is calculated as follows:

$$ERBD = - \sum_z (\Delta ECE_z \times VL)$$

where

ΔECE_z is the modelled change in expected **curtailed energy** for the **regional customer group** and **outage scenario z**, where **outage scenario z** is an **outage scenario** for the **reliability BBI**, calculated under subclause (3)

VL is—

- (a) if the **regional customer group** is a **regional demand group**, the **reliability BBI's VOLL**; or
- (b) if the **regional customer group** is a **regional supply group**, a value of lost generation determined by **Transpower**.

- (7) A **regional customer group's reliability regional NPB** for a year of the **reliability BBI's standard method calculation period** (RRNPB) is calculated as follows:

$$RRNPB = \frac{1}{\sum_s W_s} \sum_s (ERBD_s \times W_s)$$

where

$ERBD_s$ is the expected reliability benefit (positive value) or disbenefit (negative value) for the **regional customer group** and year for **market scenario s**, where **market scenario s** is a **market scenario** for the **reliability BBI**, but excluding any expected reliability benefit or disbenefit attributable to a future **customer** or future **large plant** unless the **regional customer group** is a **future regional customer group**

W_s is the probability weighting for **market scenario s** determined by **Transpower** under clause 46(1).

- (8) To avoid doubt—
- (a) expected reliability benefits and disbenefits are not summed between different **regional customer groups**; and
 - (b) all **regional demand groups**, and all members of a **regional demand group**, are assumed to have the same value of **unserved energy**, being the **reliability BBI's VOLL**; and
 - (c) all **regional supply groups**, and all members of a **regional supply group**, are assumed to have the same value of **unsupplied energy**, being the value of lost generation determined by **Transpower** under subclause (5).

55 Other Regional NPB

- (1) This clause 55 applies to calculating or estimating **other regional NPB** for a **market BBI**, **ancillary service BBI** or **reliability BBI** (if **Transpower** decides to calculate or estimate **other regional NPB** for the **BBI**).
- (2) **Transpower** must only calculate or estimate **other regional NPB** for a **BBI** if all of the following criteria are satisfied:
- (a) **Transpower** reasonably expects positive **other regional NPB** for the **BBI** to be received—
 - (i) directly by 1 or more existing **customers**, whether in their capacities as **customers** or otherwise; or
 - (ii) by the majority of **embedded plant** owners connected to a **host customer's local network** or **grid-connected plant**, whether in their capacities as **embedded plant** owners or otherwise:
 - (b) **Transpower** determines the **other regional NPB** will be a material part of total positive **regional NPB** for the **BBI**:
 - (c) **Transpower** determines the dollar value of the **other regional NPB** can be calculated or estimated to a reasonable level of certainty without **Transpower** incurring disproportionate cost.

- (3) **Transpower** must determine the **BBI's modelled regions** and **regional customer groups** as follows:

type of regional customer group	modelled region	regional customer group
regional demand group	a region in which other regional NPB is expected to arise from the BBI	all offtake customers in the modelled region expected to receive the other regional NPB
regional supply group		all injection customers in the modelled region expected to receive the other regional NPB

- (4) To avoid doubt, the **BBI customer allocations** for a **BBI** are not adjusted merely because **other regional NPB** for the **BBI** arises or is discovered after the starting **BBI customer allocations** for the **BBI** have been calculated.

Standard Method: Resiliency Method

56 Overview of Resiliency Method

- (1) Clauses 56 to 58 apply—
- (a) to the **resiliency method** only; and
 - (b) only to those **post-2019 BBIs** to which **Transpower** applies the **resiliency method** in accordance with subclause 43(2).
- (2) Under the **resiliency method**—
- (a) there is 1 **modelled region** and 1 **regional customer group**; and
 - (b) **regional NPB** for the **regional customer group** is assumed to be positive and is not calculated; and
 - (c) **individual NPB** is calculated for each **customer** in the **regional customer group**.

57 Individual NPB

A **customer's individual NPB** for the **resiliency BBI** is equal to the value of the **customer's intra-regional allocator** for the **regional customer group**.

58 Modelled Region and Regional Customer Group

Transpower must determine a **resiliency BBI's modelled region** and **regional customer group** as follows:

type of regional customer group	modelled region	regional customer group
regional demand group	the island in which the risk of cascade failure is mitigated	all offtake customers in the modelled region except in respect of grid-connected battery storage
	a region in which the risk of the HILP event is mitigated	
regional supply group	none	none

Simple Method

59 Overview of Simple Method

- (1) Clauses 59 to 64 apply—
 - (a) to the **simple method** only; and
 - (b) only to—
 - (i) those **low-value post-2019 BBIs** to which **Transpower** applies the **simple method** in accordance with subclause 43(2); and
 - (ii) those **high-value intervening BBIs** to which **Transpower** applies the **simple method** in accordance with subclause 43(3); and **anticipatory BBIs**.

- (2) Under the **simple method**—
 - (a) **regional NPB** is calculated for a **regional customer group** in respect of an **investment region** based on the extent to which the **regional customer group** is deemed to contribute to total **offtake** and **injection** in, or **electricity** flow to or from, the **investment region**, either as—
 - (i) a **regional customer group** in the **investment region**; or
 - (ii) a **regional demand group** in another **modelled region** that imports **electricity** from the **investment region** directly or indirectly; or
 - (iii) a **regional supply group** in another **modelled region** that exports **electricity** to the **investment region** directly or indirectly; and
 - (b) **individual NPB** is calculated for each **customer** in a **regional customer group** with positive **regional NPB** in respect of the **investment region**.

- (3) To avoid doubt, a **BBI** may have more than 1 **investment region** depending on where the **transmission investments** comprised in the **BBI** are located.

60 Simple Method Periods

- (1) Subject to subclause (2), the **simple method periods** are—
 - (a) the period starting on 24 July 2019 and ending at the end of the fourth **pricing year** after the **first pricing year**; and
 - (b) each period of 5 **pricing years** immediately following the end of the previous **simple method period**.

- (2) **Transpower** may start a new **simple method period** to coincide with the start of an **RCP**.

61 Individual NPB

- (1) A **customer's individual NPB** for a **BBI** in an **investment region** (NPB) is calculated as follows:

$$NPB = \sum_g (RNPB_g \times SMF_g)$$

where

$RNPB_g$ is **regional NPB** for **regional customer group g**, where **regional customer group g** is a **regional customer group** for the **BBI**—
(a) that has positive **regional NPB** in respect of the **investment region**; and
(b) of which the **customer** is a member

SMF_g is the **customer's simple method factor** for **regional customer group g**.

- (2) A **customer's simple method factor** for a **simple method period** and **regional customer group** of which the **customer** is a member (**SMF**) is calculated as follows:

$$SMF = \frac{IRA}{IRA_{total}}$$

where

IRA is the value of the **customer's intra-regional allocator** for the **simple method period** and **regional customer group**

IRA_{total} is the total of the values of all **customers' intra-regional allocators** for the **simple method period** and **regional customer group**.

- (3) If a **benefit-based charge adjustment event** in any of paragraphs 81(1)(b) to 81(1)(j) occurs between the end of **CMP C** for a **simple method period** and the start of the **simple method period**, **Transpower** must apply subclause (6) to calculating all **customers' simple method factors** for the **simple method period** as if the **benefit-based charge adjustment event** occurred during the **simple method period**.
- (4) The values of $RNPB_g$ and SMF_g under subclause (1) are those that apply when the **BBI** is **commissioned**, and **Transpower** must use those values to calculate each **customer's individual NPB** and starting **BBI customer allocation** for the **BBI**. To avoid doubt, the **BBI customer allocations** for the **BBI** do not change merely because—
(a) there are different values of **regional NPB** for a subsequent **simple method period**; or
(b) there are different **simple method factors**, **individual NPBs** and starting **BBI customer allocations** for a subsequent **simple method period**; or
(c) new or re-calculated **simple method factors**, **individual NPBs** and starting **BBI customer allocations** for a **simple method period** are calculated or re-calculated under paragraph (6)(a) or published under paragraph 64A(c).
- (5) *[Revoked]*
- (6) If a **benefit-based charge adjustment event** in any of paragraphs 81(1)(b) to 81(1)(j) occurs, **Transpower** must—
(a) calculate or re-calculate (as the case may be and to the extent affected by the **benefit-based charge adjustment event**) all **customers' simple method factors**, **individual NPBs** and starting **BBI customer allocations** for the current **simple method**

period, using estimated values for the **customers' intra-regional allocators** to the extent necessary; and

- (b) subject to this subclause (6), apply the new or re-calculated starting **BBI customer allocations** to each **BBI** commissioned during the **simple method period** after the new or re-calculated starting **BBI customer allocations** are **published** under paragraph 64A(c)..

Clause 61(4): replaced, on 31 July 2023, by clause 13(1) of the Electricity Industry Participation Code Amendment (Transmission Pricing Methodology Amendments) 2023.

Clause 61(5): revoked, on 31 July 2023, by clause 13(2) of the Electricity Industry Participation Code Amendment (Transmission Pricing Methodology Amendments) 2023.

Clause 61(6): replaced, on 31 July 2023, by clause 13(3) of the Electricity Industry Participation Code Amendment (Transmission Pricing Methodology Amendments) 2023.

62 Modelled Regions

- (1) The **modelled regions** are the **connection regions** and **HVDC link**.

(2) *[Revoked]*

- (3) **Transpower** must review, including update as appropriate, the **modelled regions** (other than the **HVDC link**) for each **simple method period** before the start of the **simple method period**.

- (4) **Transpower** must determine the **connection regions** for a **simple method period** by—

- (a) determining **high-voltage grid connection regions** on either side of the **HVDC link**; and
- (b) isolating prevailing directional **electricity flows** on **interconnection branches** in the **high-voltage grid** (excluding the **HVDC link**) over **CMP C** for the **simple method period** and determining **high-voltage grid connection regions** on either side of the **interconnection branches** on which those **electricity flows** occur; and
- (c) determining a **low-voltage grid connection region** on the **low-voltage grid** side of each **interconnection transformer branch** containing an **interconnecting transformer** connecting the **low-voltage grid** to a **high-voltage grid connection region**; and
- (d) if a **low-voltage grid connection region** is connected to more than 1 **high-voltage grid connection region**, determining separate **low-voltage grid connection regions** on either side of the minimum transfer **interconnection branch** within the **low-voltage grid connection region**, so that each of the separate **low-voltage grid connection regions** is connected to only 1 **high-voltage grid connection region**; and
- (e) for a **low-voltage connection region** connected to 1 **high-voltage connection region** by more than 1 **interconnection branch**, determining separate **low voltage grid connection regions** on either side of the minimum transfer **interconnection branch** within the **low-voltage grid connection region** if **electricity flow** on that **branch** is low relative to total **electricity flows** between **interconnecting transformers** in the **low-voltage grid connection region**; and
- (f) incorporating—
- (i) the **branches** referred to in paragraph (b) in both relevant **connection regions** in proportion to the **electricity flows** on those **branches** into each **connection region**; and
- (ii) the **branches** referred to in paragraph (c), including the **interconnecting transformers**, in the relevant **low-voltage grid connection region**; and
- (iii) the **branches** between **low-voltage connection regions** referred to in paragraphs (d) and (e) in both relevant **low-voltage connection regions** in half parts.

- (5) **Transpower**—
- (a) is not required to (but may) assess **electricity** flows over the entire **high-voltage grid** under paragraph (4)(b); and
 - (b) may amalgamate geographically adjacent **connection regions** for a **simple method period** if—
 - (i) the **connection regions** have the same voltage; and
 - (ii) 1 or more of the **connection regions** contains significantly fewer **market nodes** than the average number of **market nodes** contained in all **connection regions**.

Clause 62(2): revoked, on 31 July 2023, by clause 14 of the Electricity Industry Participation Code Amendment (Transmission Pricing Methodology Amendments) 2023.

63 Regional Customer Groups

Subject to subclause 27(3), the **regional customer groups** are as follows:

type of regional customer group	modelled region	regional customer group
regional demand group	a connection region	all offtake customers in the modelled region
regional supply group		all injection customers in the modelled region

64 Regional NPB

- (1) *[Revoked]*
- (2) **Regional NPB** for a **regional customer group** in respect of an **investment region** for a **simple method period** (RNPB) is calculated as follows:

$$RNPB = \frac{1}{\sum_t W_t} \sum_t (SMC_t \times W_t) \times F$$

where

SMC_t is the **regional customer group's simple method contribution** in respect of the **investment region** for **trading period t**, where **trading period t** is a **trading period** during **CMP C** for the **simple method period**

W_t is a weighting for **trading period t** determined by **Transpower**

F is—

- (a) if the **regional customer group** is a **regional demand group**, the **demand factor** for the **simple method period**; or
 - (b) if the **regional customer group** is a **regional supply group**, 1.
- (3) The calculation under subclause (2) must be carried out for all **trading periods** during **CMP C** for the **simple method period** for which **Transpower** determines it has access to reliable values for the variables in subclause (7).

- (4) The **demand factor** for a **simple method period** (DF) is calculated as follows:

$$DF = \frac{RNPB_{s\ total}}{RNPB_{d\ total}} \times 1.67$$

where

$RNPB_{s\ total}$ is total **regional NPB** for all **regional supply groups** in respect of all **investment regions** for the **simple method period** calculated under subclause (2)

$RNPB_{d\ total}$ is total **regional NPB** for all **regional demand groups** in respect of all **investment regions** for the **simple method period** calculated under subclause (2) but without multiplying by the **demand factor**.

- (5) Figure 14 below illustrates how, given the generalised **electricity** flow state depicted (**connection region A to B to C**)—
- the **beneficiaries** of a **BBI** located in 1 of the **connection regions** (being the **investment region**) are identified; and
 - a **regional customer group's simple method contribution** in respect of the **investment region** is calculated for a **trading period** during which, on average, the **electricity** flow state prevailed.

Figure 14

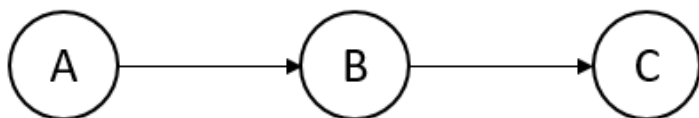

		connection region A	connection region B	connection region C
simple method contribution	regional supply group A	$\frac{G_a}{(G_a + L_a + F_{a_b})}$	$\frac{F_{a_b}}{(G_b + L_b + F_{a_b} + F_{b_c})}$	$\frac{F_{b_c}}{(G_c + L_c + F_{b_c})} \left(\frac{F_{a_b}}{G_b + L_b + F_{a_b} + F_{b_c}} \right)$
	regional supply group B	0	$\frac{G_b}{(G_b + L_b + F_{a_b} + F_{b_c})}$	$\frac{F_{b_c}}{(G_c + L_c + F_{b_c})} \left(\frac{G_b}{G_b + L_b + F_{a_b} + F_{b_c}} \right)$
	regional supply group C	0	0	$\frac{G_c}{(G_c + L_c + F_{b_c})}$
	regional demand group A	$\frac{L_a}{(G_a + L_a + F_{a_b})}$	0	0
	regional demand group B	$\frac{F_{a_b}}{(G_a + L_a + F_{a_b})} \left(\frac{L_b}{L_b + F_{b_c}} \right)$	$\frac{L_b}{(G_b + L_b + F_{a_b} + F_{b_c})}$	0
	regional demand group C	$\frac{F_{a_b}}{(G_a + L_a + F_{a_b})} \left(\frac{F_{b_c}}{L_b + F_{b_c}} \right)$	$\frac{F_{b_c}}{(G_b + L_b + F_{a_b} + F_{b_c})}$	$\frac{L_c}{(G_c + L_c + F_{b_c})}$

- (6) In figure 14 above—
- (a) the **beneficiaries** of a **BBI** in **connection region A** (being the **investment region**) are deemed to be—
- (i) the **customers** in the **regional demand group** and **regional supply group** in **connection region A**; and
 - (ii) the **customers** in the **regional demand groups** in **connection regions B** and **C**, which import **electricity** from the **investment region** directly or indirectly; and
- (b) the **beneficiaries** of a **BBI** in **connection region B** (being the **investment region**) are deemed to be—
- (i) the **customers** in the **regional demand group** and **regional supply group** in **connection region B**; and
 - (ii) the **customers** in the **regional supply group** in **connection region A**, which exports **electricity** to the **investment region** directly; and
 - (iii) the **customers** in the **regional demand group** in **connection region C**, which imports **electricity** from the **investment region** directly; and
- (c) the **beneficiaries** of a **BBI** in **connection region C** (being the **investment region**) are deemed to be—
- (i) the **customers** in the **regional demand group** and **regional supply group** in **connection region C**; and
 - (ii) the **customers** in the **regional supply groups** in **connection regions A** and **B**, which export **electricity** to the **investment region** directly or indirectly.

- (7) In figure 14 above, a **regional customer group's simple method contribution** in respect of the **investment region** (being either **connection region A, B or C**) for a **trading period** is calculated in accordance with the relevant formula in figure 14, where:

G_x is total **injection** at all **connection locations** in **connection region x** for the **trading period**

L_x is total **offtake** at all **connection locations** in **connection region x** for the **trading period**

$F_{x,y}$ is **electricity** flow from **connection region x** to **connection region y** for the **trading period**.

Clause 64(1): revoked, on 31 July 2023, by clause 15 of the Electricity Industry Participation Code Amendment (Transmission Pricing Methodology Amendments) 2023.

64A Publication of Simple Method Information

Transpower must—

- (a) **publish** the **modelled regions, regional NPB** for each **modelled region**, starting **BBI customer allocations** and all inputs to the calculation of the starting **BBI customer allocations** for the first **simple method period** before the start of the **first pricing year**; and
- (b) **publish** the **modelled regions, regional NPB** for each **modelled region**, starting **BBI customer allocations** and all inputs to the calculation of the starting **BBI customer allocations** for each subsequent **simple method period** before the start of the subsequent **simple method period**; and
- (c) if Transpower calculates or re-calculates the **simple method factors, individual NPBs** and starting **BBI customer allocations** for a **simple method period** under paragraph 61(6)(a), **publish** the new or re-calculated starting **BBI customer allocations** and all inputs to their calculation or re-calculation.

Clause 64A: inserted, on 31 July 2023, by clause 16 of the Electricity Industry Participation Code Amendment (Transmission Pricing Methodology Amendments) 2023.

Intra-regional Allocators

65 Intra-regional Allocators

- (1) Subject to subclause (2), the **intra-regional allocator** for a **regional customer group** under the **price-quantity method** is as follows:

type of BBI	type of regional customer group	intra-regional allocator	subclause
peak BBI	regional supply group	mean historical annual injection	f
	regional demand group	mean historical coincident peak offtake	(7), (8)
non-peak BBI	regional supply group	mean historical annual injection	f
	regional demand group	mean historical annual offtake	e

- (2) The **intra-regional allocator** for an **ancillary service regional customer group** under the **price-quantity method** is as follows:

specified ancillary service	type of ancillary service regional customer group	intra-regional allocator	subclause
instantaneous reserve	regional supply group	mean historical annual injection	f
frequency keeping	regional demand group	mean historical annual offtake	e
voltage support	regional demand group	mean peak kVar	(9)

- (3) The **intra-regional allocator** for the **regional customer group** under the **resiliency method** is mean historical annual **offtake** (see subclause (5)).

- (4) The **intra-regional allocator** for a **regional customer group** under the **simple method** is as follows:

type of regional customer group	intra-regional allocator	subclause
regional supply group	mean historical annual injection	(11)
regional demand group	mean historical annual offtake	(10)

- (5) Subject to subclause (13), if a **regional customer group** for a **BBI** under a **standard method** has a mean historical annual **offtake intra-regional allocator**, the value of a **pre-existing customer's intra-regional allocator** for the **regional customer group**, where the **pre-existing customer** is a member of the **regional customer group**, (IRA) is calculated as follows:

$$IRA = \frac{1}{N} \sum_n TO_n$$

where

N is the number of **capacity years** (including part **capacity years** expressed as a decimal) during **CMP B** for the relevant **BBI** for which the **pre-existing customer** was a member of the **regional customer group**

TO_n is the **pre-existing customer's total offtake** at all **connection locations** in the **regional customer group's modelled region** during **capacity year n** of **CMP B** for the **BBI**.

- (6) Subject to subclause (13), if a **regional customer group** for a **BBI** under a **standard method** has a mean historical annual **injection intra-regional allocator**, the value of a **pre-existing customer's intra-regional allocator** for the **regional customer group**, where the **pre-existing customer** is a member of the **regional customer group**, (IRA) is calculated as follows:

$$IRA = \frac{1}{N} \sum_n TI_n$$

where

N is the number of **capacity years** (including part **capacity years** expressed as a decimal) during **CMP B** for the relevant **BBI** for which the **pre-existing customer** was a member of the **regional customer group**

TI_n is the **pre-existing customer's total injection** at all **connection locations** in the **regional customer group's modelled region** during **capacity year n** of **CMP B** for the **BBI**.

- (7) Subject to subclause (13), if a **regional customer group** for a **BBI** under a **standard method** has a mean historical **coincident peak offtake intra-regional allocator**, the value of a **pre-existing customer's intra-regional allocator** for the **regional customer group**, where the **pre-existing customer** is a member of the **regional customer group**, (IRA) is calculated as follows:

$$IRA = \frac{1}{N} \sum_n \left(\frac{1}{T_n} \sum_t TO_t \right)$$

where

N is the number of **capacity years** (rounded up to the nearest whole **capacity year**) during **CMP B** for the relevant **BBI** during which the **pre-existing customer** was a member of the **regional customer group**, each such **capacity year** being **capacity year n**

T_n is the number of **peak offtake trading periods** for the **regional customer group's modelled region** and **capacity year n** during which the **pre-existing customer** was a member of the **regional customer group**, each such **peak offtake trading period** being **peak offtake trading period t**

TO_t is the **pre-existing customer's total offtake** at all **connection locations** in the **regional customer group's modelled region** for **peak offtake trading period t**.

(8) A **modelled region's peak offtake trading periods** for a **capacity year** are the **T trading periods** during the **capacity year** that have the highest total **offtake** (across all **offtake customers**) at all **connection locations** in the **modelled region**, where **T** is a number of **trading periods** between 1 and 100 **published** in the **assumptions book** for the purposes of this subclause.

(9) Subject to subclause (13), if a **regional customer group** for a **BBI** under a **standard method** has a mean peak kVar **intra-regional allocator**, the value of a **pre-existing customer's intra-regional allocator** for the **regional customer group**, where the **pre-existing customer** is a member of the **regional customer group**, (**IRA**) is calculated as follows:

$$IRA = \frac{1}{N} \sum_n NPK_n$$

where

N is the number of **capacity years** (rounded up to the nearest whole **capacity year**) during **CMP B** for the relevant **BBI** for which the **pre-existing customer** was a member of the **regional customer group**

NPK_n is the **pre-existing customer's nominated peak kVar** for the **regional customer group's modelled region** and **capacity year n** of **CMP B** for the **BBI**.

(10) Subject to subclause (13), if a **regional customer group** for a **BBI** under the **simple method** has a mean historical annual **offtake intra-regional allocator**, the value of a **pre-existing customer's intra-regional allocator** for the **regional customer group**, where the **pre-existing customer** is a member of the **regional customer group**, (**IRA**) is calculated as follows:

$$IRA = \frac{1}{N} \sum_n TO_n$$

where

N is the number of **capacity years** (including part **capacity years** expressed as a decimal) during **CMP C** for the relevant **simple method period** for which the **pre-existing customer** was a member of the **regional customer group**

TO_n is the **pre-existing customer's total offtake** at all **connection locations** in the **regional customer group's modelled region** during **capacity year n** of **CMP C** for the **simple method period**.

(11) Subject to subclause (13), if a **regional customer group** for a **BBI** under the **simple method** has a mean historical annual **injection intra-regional allocator**, the value of a **pre-existing**

customer's intra-regional allocator for the **regional customer group**, where the **pre-existing customer** is a member of the **regional customer group**, (IRA) is calculated as follows:

$$IRA = \frac{1}{N} \sum_n TI_n$$

where

N is the number of **capacity years** (including part **capacity years** expressed as a decimal) during **CMP C** for the relevant **simple method period** for which the **pre-existing customer** was a member of the **regional customer group**

TI_n is the **pre-existing customer's total injection** at all **connection locations** in the **regional customer group's modelled region** during **capacity year n** of **CMP C** for the **simple method period**.

- (12) Subclause (13) applies if—
- (a) one or more **specified pre-start adjustment events** for a **BBI** under a **standard method** and a **pre-existing customer** occurred during **CMP B** for the **BBI**; or
 - (b) one or more **specified pre-start adjustment events** for a **BBI** under the **simple method** and a **pre-existing customer** occurred during **CMP C** for the relevant **simple method period**.
- (13) If this subclause applies under subclause (12), **Transpower** must estimate the value of the **pre-existing customer's intra-regional allocator** under clause 66 as if the **pre-existing customer** were a **recent customer**, but also taking into account the full impact of the **specified pre-start adjustment events**.

66 Recent Customers

The value of a **recent customer's intra-regional allocator** for a **regional customer group** is estimated under paragraph 83(3)(a) as if the **recent customer** were a new **customer** joining the **regional customer group**, but also taking into account any available historical information about the **recent customer's** mean historical annual **injection**, mean historical annual **offtake** or mean historical **coincident peak offtake** (as the case may be).

67 Notional IRA Value

If a **regional customer group** is a **future regional customer group**, **Transpower** must determine a value of the **intra-regional allocator** for a notional **pre-existing customer** who accounts for all of the **future regional customer group's market regional NPB**, being the **notional IRA value** for the **future regional customer group**.

Part E Residual Charges

68 Calculation of Residual Charges

- (1) Only load customers pay residual charges.
- (2) A load customer's annual residual charge for a pricing year (ARC) is calculated as follows:

$$ARC = AMDR \times RCR$$

where

AMDR is the load customer's AMDR for the pricing year

RCR is the residual charge rate for the pricing year calculated under clause 74.

- (3) A load customer's monthly residual charge for a pricing year (MRC) is calculated as follows:

$$MRC = \frac{ARC}{12}$$

where ARC is the load customer's annual residual charge for the pricing year.

- (4) Residual charges are calculated for each pricing year before the start of the pricing year.
- (5) A residual charge may be re-calculated, including during a pricing year, under clauses 92 to 95 if there is a residual charge adjustment event.

69 Anytime Maximum Demand (Residual)

- (1) A load customer's AMDR for pricing year n ($AMDR_n$) is—
 - (a) 0 if the load customer became a customer at or after the start of financial year $n-4$; or
 - (b) calculated as follows if the load customer became a customer before the start of financial year $n-4$ and at or after the start of financial year $n-8$:

$$AMDR_n = AMDR_{baseline} \times \left(\frac{n-m}{4} - 1 \right)$$

where

m is the financial year during which the load customer became a customer

$AMDR_{baseline}$ is the load customer's AMDR baseline calculated or estimated under clause 70; or

- (c) otherwise, calculated as follows:

$$AMDR_n = AMDR_{baseline} \times RCAF_n$$

where

$AMDR_{baseline}$ is the load customer's AMDR baseline calculated or estimated under clause 70

$RCAF_n$ is the load customer's RCAF for pricing year n .

70 Anytime Maximum Demand (Residual) Baseline

- (1) Subject to subclause 72(1), a **pre-existing load customer's AMDR** baseline ($AMDR_{baseline}$) is calculated as follows:

$$AMDR_{baseline} = \frac{1}{4} \sum_{n=2014}^{2017} \sum_l MGD_{ln}$$

where MGD_{ln} is the **pre-existing load customer's maximum gross demand** for **connection location l** and **financial year n**.

- (2) A **recent load customer's AMDR** baseline—

- (a) is estimated by **Transpower** as if the **recent load customer's assets** were fully operational from the start of **CMP D** and taking into account—

- (i) the type and **capacity** of the **recent load customer's assets**; and
- (ii) the **AMDR** baselines for any other **load customers** with **assets** of the same or a similar type as the **recent load customer's assets**; and
- (iii) any available information about the **recent load customer's maximum gross demand**,

but excluding any contribution to the **recent load customer's maximum gross demand** from the charging or discharging of **large battery storage** other than the **battery storage's** energy losses; and

- (b) may be re-estimated by **Transpower** under clause 73.

71 Residual Charge Adjustment Factor

- (1) A **load customer's RCAF** for **pricing year n** ($RCAF_n$) is calculated as follows:

$$RCAF_n = \frac{LATGE_n}{ATGE_{baseline}}$$

where

$LATGE_n$ is the **load customer's lagged average total gross energy** for **pricing year n** calculated under subclause (2)

$ATGE_{baseline}$ is the **load customer's average total gross energy** baseline calculated or estimated under subclause (4) or (5).

- (2) A **load customer's lagged average total gross energy** for **pricing year n** ($LATGE_n$) is calculated as follows:

$$LATGE_n = \frac{1}{4} \sum_{m=n-8}^{n-5} F_m \times TGE_m$$

where

F_m is—

- (a) if—
 - (i) the **load customer** is a **pre-existing load customer**; and
 - (ii) there has been one or more **reduction events** for the **load customer** that occurred after the end of **financial year m**,

- the **reduction event** adjustment factor for the **load customer** and **financial year m** calculated under subclause (3); or
- (b) otherwise, 1

TGE_m is—

- (a) if—
- (i) the **load customer** is a **pre-existing load customer**; and
- (ii) there has been one or more **reduction events** for the **load customer** that occurred during **financial year m**,
 $ATGE_{after}$ as defined in subclause (3), immediately after the most recent such **reduction event**; or
- (b) otherwise, the **load customer's total gross energy** for **financial year m**.

- (3) The **reduction event** adjustment factor for a **load customer** and **financial year m** ($REAF_m$) is calculated as follows:

$$REAF_m = 1 - \frac{ATGE_{before} - ATGE_{after}}{ATGE_{before}}$$

where

$ATGE_{after}$ is the **load customer's average total gross energy** baseline immediately after the reduction under subclause 72(2) for the latest **reduction event** that occurred after the end of **financial year m**

$ATGE_{before}$ is the **load customer's average total gross energy** baseline immediately before the reduction under subclause 72(2) for the earliest **reduction event** that occurred after the end of **financial year m**.

- (4) Subject to subclause 72(2), a **pre-existing load customer's average total gross energy** baseline ($ATGE_{baseline}$) is calculated as follows:

$$ATGE_{baseline} = \frac{1}{4} \sum_{n=2014}^{2017} TGE_n$$

where TGE_n is the **pre-existing load customer's total gross energy** for **financial year n**.

- (5) A **recent load customer's average total gross energy** baseline—
- (a) is estimated by **Transpower** as if the **recent load customer's assets** were fully operational from the start of **CMP D** and taking into account—
- (i) the type and **capacity** of the **recent load customer's assets**; and
- (ii) the **total gross energy** baselines for any other **load customers** with **assets** of the same or a similar type as the **recent load customer's assets**; and
- (iii) any available information about the **recent load customer's total gross energy**, but excluding any contribution to the **recent load customer's total gross energy** from the charging or discharging of **large battery storage** other than the **battery storage's energy losses**; and
- (b) may be re-estimated by **Transpower** under clause 73.

- (6) To avoid doubt, a **load customer's RCAF** for a **pricing year** is only calculated if the **load customer's AMDR** for the **pricing year** is calculated under clause 69(1)(c).

Clause 71(2): amended, on 22 March 2023, by clause 4 of the Electricity Industry Participation Code Amendment (Residual Charge Adjustment Factor) 2023.

Clause 71(2): replaced, on 31 July 2023, by clause 17 of the Electricity Industry Participation Code Amendment (Transmission Pricing Methodology Amendments) 2023.

Clause 71(3): amended, on 22 March 2023, by clause 4 of the Electricity Industry Participation Code Amendment (Residual Charge Adjustment Factor) 2023.

Clause 71(3): replaced, on 31 July 2023, by clause 17 of the Electricity Industry Participation Code Amendment (Transmission Pricing Methodology Amendments) 2023.

72 Reduction Events

- (1) **Transpower** may reduce a **pre-existing load customer's AMDR** baseline by an amount determined by **Transpower**—
 - (a) if a **reduction event** for the **pre-existing load customer** has occurred or **Transpower** determines will occur; and
 - (b) to the extent the impact of the **reduction event** is not fully captured in the calculation of the **pre-existing load customer's AMDR** baseline under subclause 70(1).
- (2) If **Transpower** reduces a **pre-existing load customer's AMDR** baseline under subclause (1), **Transpower** must also reduce the **pre-existing load customer's** average **total gross energy** baseline to the extent necessary to be consistent with the reduction in the **pre-existing customer's AMDR** baseline, as determined by **Transpower**.
- (3) To avoid doubt, the time when a **reduction event** occurred or will occur is determined by **Transpower**.

73 Re-estimating for Recent Load Customers

- (1) **Transpower** may re-estimate either or both of a **recent load customer's AMDR** baseline and average **total gross energy** baseline—
 - (a) when information is available to **Transpower** about the **recent load customer's maximum gross demand** or **total gross energy** when the **recent load customer's** assets are fully operational, but may only re-estimate each of the **recent load customer's AMDR** baseline and average **total gross energy** baseline under this paragraph once; or
 - (b) if **Transpower** determines information relevant to **Transpower's** estimate of the **recent load customer's AMDR** baseline or average **total gross energy** baseline provided to **Transpower** by or on behalf of the **recent load customer** was false or misleading.
- (2) To avoid doubt, the purpose of a re-estimation under subclause a is to correct any material under- or over-estimation in **Transpower's** estimate of the **recent load customer's AMDR** baseline or average **total gross energy** baseline.

74 Residual Charge Rate

The **residual charge** rate for a **pricing year** (RCR) is calculated as follows:

$$RCR = \frac{RR}{AMDR_{total}}$$

where

RR is **residual revenue** for the **pricing year**

AMDR_{total} is the total of all **customers' AMDR** for the **pricing year**.

Part F Adjustments

General

75 Adjustment Events

- (1) Subject to subclauses (4) and (5), an **adjustment event** is deemed to have occurred on the date **Transpower** has actual knowledge, and is reasonably satisfied, that the **adjustment event** has occurred, regardless of when the **adjustment event** actually occurred.
- (2) Except as otherwise stated in this **transmission pricing methodology**, if an **adjustment event** occurs, **Transpower** must adjust relevant **transmission charges** from the date of the **adjustment event**, if necessary on a pro rata basis for the **event pricing year** depending on when the **adjustment event** occurred during the **event pricing year**.
- (3) If **adjustment events** affecting the same **transmission charge** occur simultaneously, **Transpower** must determine an order in which the **adjustment events** will be deemed to have occurred for the purpose of adjusting the **transmission charge**.
- (4) Subject to subclauses (6) and (7), if a **pre-start adjustment event** for a **post-2019 BBI** has occurred, **Transpower** must treat the **pre-start adjustment event** as a **benefit-based charge adjustment event** that occurred or will occur at the start of the **post-2019 BBI's start pricing year** and—
 - (a) if **Transpower** determines it is reasonably practicable to do so, factor the **pre-start adjustment event** into its calculation of relevant **transmission charges** from the start of the **post-2019 BBI's start pricing year**; or
 - (b) otherwise, process the **pre-start adjustment event** as a **benefit-based charge adjustment event** during the **start pricing year**.
- (5) Subject to subclauses (6) to (8), if a **pre-commencement adjustment event** has occurred, **Transpower** must treat the **pre-commencement adjustment event** as an **adjustment event** that occurred or will occur at the start of the **first pricing year** and—
 - (a) if **Transpower** determines it is reasonably practicable to do so, factor the **pre-commencement adjustment event** into its calculation of relevant **transmission charges** from the start of the **first pricing year**; or
 - (b) otherwise, process the **pre-commencement adjustment event** as an **adjustment event** during the **first pricing year**.
- (6) Unless a **pre-start adjustment event** or **pre-commencement adjustment event** is a **SSCGU**, **Transpower** is not required to (but may) factor the **pre-start adjustment event** or **pre-commencement adjustment event** into its calculation of **regional NPB** under paragraph (4)(a) or (5)(a).
- (7) Neither subclause (4) nor (5) applies to a **pre-start adjustment event** or **pre-commencement adjustment event** that is a **specified pre-start adjustment event** to which subclause 65(13) applies.
- (8) Subclause (5)—
 - (a) does not apply to a **pre-commencement adjustment event** for an **Appendix A BBI** that—
 - (i) occurred on or before 10 June 2020 (being the date the **Authority** published the **2020 guidelines**); or
 - (ii) is reflected in Appendix A through an adjustment of the type referred to in subclause 42(2); and

- (b) subject to paragraph (a), applies to a **benefit-based charge** for an **Appendix A BBI** despite the starting **beneficiaries** and starting **BBI customer allocations** for the **Appendix A BBI** specified in Appendix A.

Connection Charges

76 Connection Charge Adjustment Events

- (1) The following events are **connection charge adjustment events**:
- (a) a **customer** (the connecting **customer**) connects at a **connection location** at which the **customer** is not already connected;
 - (b) a **customer** (the disconnecting **customer**) disconnects from a **connection location**;
 - (c) a **customer** (the vendor) sells or otherwise transfers all or part of its business that constitutes it as a **customer** at a **connection location** to another party (the purchaser);
 - (d) **Transpower** decides to voluntarily under-recover the **connection charges** for a **connection asset, connection location** or **connection transmission alternative**.
- (2) **Transpower** must not voluntarily under-recover the **connection charge** for a **connection asset, connection location** or **connection transmission alternative** if the effect of doing so would be to increase **residual revenue** for any **pricing year**.
- (3) To avoid doubt, a vendor's sale or other transfer of all or part of its business that constitutes it as a **customer** at a **connection location** to a purchaser is treated as the **connection charge adjustment event** in paragraph (1)(c) and not the **connection charge adjustment event** in paragraph (1)(a) or (1)(b).

77 Connection Charge Adjustment Event: Connecting Customer

- (1) This clause 77 applies in the case of the **connection charge adjustment event** in paragraph 76(1)(a).
- (2) In this clause 77, a relevant **pricing year** is the **event pricing year** and the **pricing year** after the **event pricing year**.
- (3) **Transpower** must, for each relevant **pricing year**—
- (a) determine whether the connecting **customer** will be treated as an **offtake customer** or **injection customer** at the **connection location**; and
 - (b) estimate the connecting **customer's** **AMDC** or **AMIC** (as applicable depending on **Transpower's** determination under paragraph (a) for the **connection location** taking into account—
 - (i) the type and **capacity** of the connecting **customer's** **assets**; and
 - (ii) **AMDC** or **AMIC** (as the case may be) for any other **customers** with **assets** of the same or a similar type as the new **customer's** **assets** connected at the **connection location**; and
 - (c) calculate or re-calculate (as the case may be) all **customers' connection customer allocations** for the **connection location** to account for the connecting **customer's** **AMDC** or **AMIC** estimated under paragraph (b); and
 - (d) calculate or re-calculate (as the case may be) all **customers' connection charges** for the **connection location** based on the **customers' connection customer allocations** calculated under paragraph (c); and
 - (e) calculate or re-calculate (as the case may be) all **customers' connection charges** for any relevant **connection transmission alternative**—

- (i) to account for the connecting **customer's annual connection charge** for the **connection location** calculated under paragraph (d); and
 - (ii) assuming that **annual connection charge** applied for the previous **pricing year**.
- (4) **Transpower** must start the connecting **customer's monthly connection charges** calculated under paragraph (3)(d) or (3)(e) as soon as reasonably practicable. The connecting **customer's monthly connection charges** may include an adjustment as necessary to ensure the connecting **customer** pays its full **connection charges** for the **connection location** or **connection transmission alternative** from the date the connecting **customer** connected at the **connection location**.
- (5) **Transpower** is not required to (but may) start any other **customer's monthly connection charges** re-calculated under paragraph (3)(d) or (3)(e) during, or from the start of, an **exempt pricing year** for the **customer**. However, any over-recovery of **annual connection charges** for the **connection location** or **connection transmission alternative** and **exempt pricing year** resulting from the start of the connecting **customer's monthly connection charges** for the **connection location** or **connection transmission alternative** must be rebated, as appropriate, to the other **customers** by way of an adjustment to their **transmission charges**—
 - (a) if reasonably practicable, at the end of the **exempt pricing year**; or
 - (b) otherwise, as soon as reasonably practicable during the next **pricing year**.

78 Connection Charge Adjustment Event: Disconnecting Customer

- (1) This clause 78 applies in the case of the **connection charge adjustment event** in paragraph 76(1)(b).
- (2) **Transpower**—
 - (a) must make the disconnecting **customer's connection customer allocations** (and the inputs to their calculation) and **connection charges** for the **connection location** and any relevant **connection transmission alternative** 0; and
 - (b) must not increase—
 - (i) any other **customer's connection charges** for the **connection location** or **connection transmission alternative** and **event pricing year**; or
 - (ii) any other **transmission charges** for the **event pricing year**, as a consequence of applying paragraph (a).

79 Connection Charge Adjustment Event: Sale of Business

- (1) This clause 79 applies in the case of the **connection charge adjustment event** in paragraph 76(1)(c).
- (2) In this clause 79, a relevant **pricing year** is the **event pricing year** and the **pricing year** after the **event pricing year**.
- (3) **Transpower** must, for a sale of part of the vendor's business and for each relevant **pricing year**—
 - (a) determine an apportionment between the vendor and purchaser of the vendor's **connection customer allocations** (and the inputs to their calculation) for the **connection location** taking into account the size and nature of the transferred business; and
 - (b) calculate or re-calculate (as the case may be) the vendor's and purchaser's **connection charges** for the **connection location** based on the apportionment of the vendor's **connection customer allocations** under paragraph (a); and
 - (c) calculate or re-calculate (as the case may be) the vendor's and purchaser's **connection charges** for any relevant **connection transmission alternative**—

- (i) to account for the vendor's and purchaser's **annual connection charges** for the **connection location** calculated under paragraph (b); and
 - (ii) assuming those **annual connection charges** applied for the previous **pricing year**.
- (4) **Transpower** must, for a sale of all of the vendor's business and for each relevant **pricing year**—
 - (a) attribute all of the vendor's **connection customer allocation** (and the inputs to its calculation) for the **connection location** to the purchaser; and
 - (b) calculate or re-calculate (as the case may be) the purchaser's **connection charges** for the **connection location** based on the attribution of the vendor's **connection customer allocation** under paragraph (a); and
 - (c) calculate or re-calculate (as the case may be) the purchaser's **connection charge** for any relevant **connection transmission alternative**—
 - (i) to account for the purchaser's **annual connection charges** for the **connection location** calculated under paragraph (b); and
 - (ii) assuming those **annual connection charges** applied for the previous **pricing year**.
- (5) **Transpower** must start the purchaser's **monthly connection charges** calculated under paragraph (3)(b), (3)(c), (4)(b) or (4)(c) as soon as reasonably practicable. The purchaser's **monthly connection charges** may include an adjustment as necessary to ensure the purchaser pays its full **connection charges** for the **connection location** or **connection transmission alternative** from the date of the transfer.
- (6) **Transpower** is not required to (but may) start the vendor's **monthly connection charges** calculated under paragraph (3)(b) or (3)(c) during, or from the start of, an **exempt pricing year** for the vendor. However, any over-recovery of **annual connection charges** for the **connection location** or **connection transmission alternative** and **exempt pricing year** resulting from the start of the purchaser's **monthly connection charges** for the **connection location** or **connection transmission alternative** must be rebated to the vendor by way of an adjustment to its **transmission charges**—
 - (a) if reasonably practicable, at the end of the **exempt pricing year**; or
 - (b) otherwise, as soon as reasonably practicable during the next **pricing year**.

80 Connection Charge Adjustment Event: Voluntary Under-recovery

- (1) This clause 80 applies in the case of the **connection charge adjustment event** in paragraph 76(1)(d).
- (2) In this clause 80, a relevant **pricing year** is a **pricing year** for which **Transpower** decided to voluntarily under-recover the **connection charges** for the **connection asset, connection location** or **connection transmission alternative**.
- (3) **Transpower** must, for each relevant **pricing year**, calculate or re-calculate (as the case may be) all customers' **connection charges** for the **connection asset, connection location** or **connection transmission alternative** to account for the amount of the voluntary under-recovery of the **connection charges**.
- (4) If **Transpower** decides to voluntarily under-recover the **connection charges** for the **connection asset, connection location** or **connection transmission alternative** and a relevant **pricing year** during, or within 1 month of the start of, the relevant **pricing year**, **Transpower** is not required to (but may) start customers' **monthly connection charges** calculated under subclause (3) during, or from the start of, the relevant **pricing year**. However, any over-recovery of **annual connection charges** for the **connection asset, connection location** or **connection transmission alternative** and relevant **pricing year** (accounting for the voluntary under-recovery) must be

rebated, as appropriate, to the **customers** by way of an adjustment to their **transmission charges**—

- (a) if reasonably practicable, at the end of the relevant **pricing year**; or
- (b) otherwise, as soon as reasonably practicable during the next **pricing year**.

Benefit-based Charges

81 Benefit-based Charge Adjustment Events

- (1) The following events are **benefit-based charge adjustment events**:
 - (a) a **BBI** suffers **material damage**;
 - (b) a new **customer** connects to the **grid**;
 - (c) a **customer** (the exiting **customer**) ceases to be a **customer**;
 - (d) an existing **customer** (the connecting or disconnecting **customer**) connects **plant** to, or disconnects **plant** from, the **grid**;
 - (e) **large embedded plant** is connected to, or **large embedded plant** is disconnected from, a **host customer's** (the connecting or disconnecting **customer's**) **local network** or **grid-connected plant**;
 - (f) there is a **substantial sustained increase** by a **customer's** (the increasing **customer's**) existing **grid-connected plant**;
 - (g) there is a **substantial sustained increase** by existing **large embedded plant** connected to a **host customer's** (the increasing **customer's**) **local network** or **grid-connected plant**;
 - (h) a **distributor** (the connecting **distributor**) connects its **local network** at a **grid point of connection** (new **grid point of connection**) to which the connecting **distributor** was not connected immediately before connecting its **local network** at the new **grid point of connection**;
 - (i) the **point of connection** for existing **large plant** changes;
 - (j) a **customer** (the vendor) sells or otherwise transfers all or part of its business that constitutes it as a **beneficiary** of a **BBI** to another party (the purchaser);
 - (k) **Transpower** decides to voluntarily under-recover a **BBI's covered cost**;
 - (l) there is a **SSCGU**.
- (2) **Transpower** must not voluntarily under-recover a **BBI's covered cost** if the effect of doing so would be to increase **residual revenue** for any **pricing year**.
- (3) For the purposes of paragraphs (1)(d) and (1)(e)—
 - (a) a **large upgrade** of existing **plant** is treated as the connection of **large plant** equivalent in size to the **upgrade**; and
 - (b) a **large de-rating** of existing **plant** is treated as the disconnection of **large plant** equivalent in size to the **de-rating**; and
 - (c) a series of incremental **upgrades** or **de-ratings** of existing **plant** is treated as a **large upgrade** or **large de-rating** (as the case may be) if the incremental **upgrades** or **de-ratings** would constitute a **large upgrade** or **large de-rating** if undertaken at the same time.
- (4) For the purposes of paragraphs (1)(f) and (1)(g), whether the increase in **electricity** consumed or generated by the **large plant** is a **substantial sustained increase** in respect of a **BBI** must be assessed against the average annual **electricity** consumption or generation by the **large plant** explicitly or implicitly included in the current value of the increasing **customer's intra-regional allocator** for its **regional customer group** and the **BBI**.

- (5) To avoid doubt, the **benefit-based charge adjustment events** in paragraphs (1)(a) and (1)(k) do not result in any change to the relevant **BBI's BBI customer allocations**.
- (6) The **benefit-based charge adjustment event** in paragraph (1)(i) is treated as the **benefit-based charge adjustment events** in 1 or both of paragraphs (1)(d) and (1)(e) (depending on the previous and new **point of connection**) occurring in respect of the same **large plant**, provided that clause 85 will not apply except as specified in clause 88.
- (7) To avoid doubt, a vendor's sale or other transfer of all or part of its business that constitutes it as a **beneficiary** of a **BBI** to a purchaser is treated as the **benefit-based charge adjustment event** in paragraph (1)(j) and not the **benefit-based charge adjustment event** in paragraph (1)(b) or (1)(c).
- (8) Any of the **benefit-based charge adjustment events** in paragraphs (1)(b) to (1)(j) may also be a **SSCGU**, in which case both clause 91 and clause 83, 84, 85, 86, 87 or 88 (as applicable depending on the **benefit-based charge adjustment event**) will apply. However, clause 83, 84, 85, 86, 87 or 88 will only apply to a relevant **BBI** described in paragraph 91(2)(a) in respect of **pricing years** before the **SSCGU's start pricing year**.
- (9) For the purposes of subclauses 84(5), 84(6), 85(4) and 85(5) (which relate to **continuing BBIs**)—
 - (a) the Bunnythorpe Haywards **Appendix A BBI** is deemed to have a **commissioning date** of 9 May 2015; and
 - (b) the **post-2019 CUWLP investment** is deemed to have a **commissioning date** of 1 January 2021; and
 - (c) if the **commissioning date** of any other **high-value intervening BBI** is not known to **Transpower**, the **high-value intervening BBI** is deemed to have a **commissioning date** determined by **Transpower**.

82 Benefit-based Charge Adjustment Event: Material Damage

- (1) This clause 82 applies in the case of the **benefit-based charge adjustment event** in paragraph 81(1)(a).
- (2) In this clause 82, a relevant **pricing year** is—
 - (a) the **event pricing year**; and
 - (b) each subsequent **pricing year** for which a **write-down** due to the **material damage** is not reflected in the **RAB** values or **values of commissioned asset** used to calculate the **BBI's covered cost** for the **pricing year**.
- (3) Subject to subclause (4), **Transpower** must, for each relevant **pricing year**—
 - (a) reduce the **BBI's covered cost** by an amount determined by **Transpower** to reflect a reasonable **write-down** of the **BBI** due to the **material damage**; and
 - (b) calculate or re-calculate (as the case may be) all **beneficiaries' benefit-based charges** for the **BBI** based on the reduction of the **BBI's covered cost** under paragraph (a).
- (4) If a **beneficiary** (the causing **beneficiary**) caused, or contributed to the cause of, the **material damage**, subclause (3) does not apply to the causing **beneficiary's benefit-based charge** for the **BBI**.
- (5) **Transpower** is not required to (but may) start a **beneficiary's monthly benefit-based charge** calculated under paragraph (3)(b) during, or from the start of, an **exempt pricing year** for the **beneficiary**. However, any over-recovery of the **BBI's covered cost** for the **exempt pricing**

year (accounting for the **material damage**) must be rebated, as appropriate, to the **beneficiaries** (other than any causing **beneficiary**) by way of an adjustment to their **transmission charges**—

- (a) if reasonably practicable, at the end of the **exempt pricing year**; or
- (b) otherwise, as soon as reasonably practicable during the next **pricing year**.

- (6) **Transpower** must not increase any **transmission charges** for the **event pricing year** as a consequence of applying subclause (3).

83 Benefit-based Charge Adjustment Event: New Customer

- (1) This clause 83 applies in the case of the **benefit-based charge adjustment event** in paragraph (81)(1)(b).

- (2) The new **customer**—

- (a) is a **beneficiary** of each **post-2019 BBI** (a relevant **post-2019 BBI**) that has positive **regional NPB** for a **regional customer group** of which the new **customer** is expected to be a member (a relevant **regional customer group** for the relevant **post-2019 BBI**); and
- (b) may be a **beneficiary** of 1 or more of the **Appendix A BBIs**.

- (3) **Transpower** must, for each relevant **post-2019 BBI**—

- (a) estimate the value of the new **customer's intra-regional allocator** for each relevant **regional customer group** as if the new **customer's assets** were fully operational and taking into account—
 - (i) the type and **capacity** of the new **customer's assets**; and
 - (ii) the values of the **intra-regional allocators** for any other **customers** with **assets** of the same or a similar type as the new **customer's assets**; and
- (b) subject to subclause (4) and applying subclause (13) if required, calculate the new **customer's individual NPB** for the relevant **post-2019 BBI**—
 - (i) under clause 47, 57 or 61 (as applicable depending on the method used to calculate **beneficiaries' BBI customer allocations** for the relevant **post-2019 BBI**); and
 - (ii) based on the value of the new **customer's intra-regional allocator** for each relevant **regional customer group** estimated under paragraph (a), but excluding the value of the new **customer's intra-regional allocator** from the denominator of the formula in clause 47 or subclause 61(2) (as applicable) unless the **regional customer group** had no members immediately before the new **customer** joined it; and
- (c) calculate the new **customer's BBI customer allocation** for the relevant **post-2019 BBI** based on the new **customer's individual NPB** for the relevant **post-2019 BBI** calculated under paragraph (b), but excluding the value of the new **customer's individual NPB** from the denominator of the formula in subclause 43(1); and
- (d) scale down all **beneficiaries' (including the new customer's) BBI customer allocations** for the relevant **post-2019 BBI** by a factor (F) calculated as follows:

$$F = \frac{1}{1 + CA}$$

where CA is the new **customer's BBI customer allocation** for the relevant **post-2019 BBI** calculated under paragraph (c); and

- (e) calculate or re-calculate (as the case may be) all **beneficiaries' benefit-based charges** for the relevant **post-2019 BBI** based on the **beneficiaries' BBI customer allocations** calculated under paragraph (d).

- (4) If the new **customer** is in a **future regional customer group** for a relevant **BBI**, **Transpower** must calculate the new **customer's individual NPB** for the relevant **BBI** under paragraph (3)(b) in respect of the **future regional customer group** by using the **future regional customer group's notional IRA value** in the denominator of the formula in clause 47.
- (5) The following tables illustrate the application of subclause (3) to a new **customer** (**customer E**) entering **regional customer group Y** for a **post-2019 BBI** under the **price-quantity method** where **regional customer group Y** is not a **future regional customer group**:

Before

regional customer group	beneficiary	regional NPB	intra-regional allocator	individual NPB	BBI customer allocation
X	A	60	1	20	18.18%
	B		2	40	36.36%
Y	C	50	3	30	27.27%
	D		2	20	18.18%

Transition (paragraphs (3)(a) to (3)(c))

regional customer group	beneficiary	regional NPB	intra-regional allocator	individual NPB	BBI customer allocation
X	A	60	1	20	18.18%
	B		2	40	36.36%
Y	C	50	3	30	27.27%
	D		2	20	18.18%
	E		1 (estimated)	$1/5 \times 50 = 10$	$10/110 = 9.09\%$

After (paragraph (3)(d))

regional customer group	beneficiary	regional NPB	intra-regional allocator	individual NPB	BBI customer allocation (scaled by 1/1.0909)
X	A	60	1	20	16.67%
	B		2	40	33.33%
Y	C	50	3	30	25.00%
	D		2	20	16.67%
	E		1 (estimated)	10	8.33%

- (5A) Subclause (5C) applies to the new **customer's benefit-based charges** for **post-2019 BBIs** under the **simple method** if—

$$BBC_{(3) \text{ total}} > SMBC$$

where

$BBC_{(3) \text{ total}}$ is the new **customer's total benefit-based charges** for relevant **post-2019 BBIs** under the **simple method** if calculated under subclause (3)

SMBC is the new **customer's simple method BBC cap**.

(5B) Subject to subclause (9A), the new **customer's simple method BBC cap** (SMBC) is calculated as follows:

$$SMBC = E \times \frac{1}{J} \sum_j \frac{BBC_{j\ total}}{E_j}$$

where

E is **Transpower's** estimate of the value of the new **customer's intra-regional allocator** for the relevant **regional customer group** under paragraph 83(3)(a)

J is the number of **customers** of the same type as the new **customer (generator or connected asset owner)**—

- (a) at the new **customer's connection location**; or
- (b) if there are no such **customers** at the new **customer's connection location**, at the **connection location** electrically closest to the new **customer's connection location** at which there is 1 or more such **customers**, as determined by **Transpower**,

each such **customer** being **customer j**

$BBC_{j\ total}$ is **customer j's total annual benefit-based charges** for **BBIs** under the **simple method** for the current **pricing year** and **regional customer group** in which **customer j's connection location** is located

E_j is the value of **customer j's intra-regional allocator** for the current **simple method period** and **regional customer group** in which **customer j's connection location** is located.

(5C) If this subclause applies under subclause (5A), **Transpower** must, instead of applying the new **customer's benefit-based charges** for the relevant **post-2019 BBIs** under the **simple method** calculated under subclause (3)—

(a) attribute part of the new **customer's simple method BBC cap** to each **investment region** in respect of which the relevant **regional customer group** has positive **regional NPB** as follows:

$$SMBC_{region} = SMBC \times \frac{BBC_{(3)}}{BBC_{(3)\ total}}$$

where

$SMBC_{region}$ is the **part** of the new **customer's simple method BBC cap** attributed to the **investment region**

SMBC is the new **customer's simple method BBC cap**

$BBC_{(3)}$ is the part of the new **customer's annual benefit-based charges** for the relevant **post-2019 BBIs** under the **simple method** attributed to the **investment region** if calculated under paragraph 83(3)(e)

$BBC_{(3) \text{ total}}$ is the new **customer's total annual benefit-based charges** for the relevant **BBIs** under the **simple method** if calculated under paragraph 83(3)(e); and

- (b) calculate the new **customer's BBI customer allocation** for each relevant **post-2019 BBI** (CA) as follows:

$$CA = \frac{SMBC_{region}}{CC_{region \text{ total}}}$$

where

$SMBC_{region}$ is the part of the new **customer's simple method benefit cap** attributed to the **investment region** in which the relevant **post-2019 BBI** is located under paragraph (a)

$CC_{region \text{ total}}$ is the total **covered cost** of all relevant **post-2019 BBIs** under the **simple method** located in the **investment region** for the current **pricing year**; and

- (c) scale down all **beneficiaries'** (including the new **customer's**) **BBI customer allocations** for each relevant **post-2019 BBI** by a factor (F) calculated as follows:

$$F = \frac{1}{1 + CA}$$

where CA is the new **customer's BBI customer allocation** for the relevant **post-2019 BBI** calculated under paragraph (b); and

- (d) calculate or re-calculate (as the case may be) all **beneficiaries' benefit-based charges** for each relevant **post-2019 BBI** based on the **beneficiaries' BBI customer allocations** calculated under paragraph (c).

- (6) **Transpower** must, for each **Appendix A BBI**—

- (a) subject to subclause (9A), calculate the new **customer's BBI customer allocation** for the **Appendix A BBI** (CA) as follows:

$$CA = E \times \frac{1}{J} \sum_j BF_j$$

where

E is **Transpower's** estimate of the new **customer's average annual offtake or injection** at the new **customer's connection location** when the new **customer's assets** are fully operational

J is the number of **Appendix A customers** of the same type as the new **customer (generator or connected asset owner)**—
(i) at the new **customer's connection location**; or
(ii) if there are no such **Appendix A customers** at the new **customer's connection location**, at the **connection location** electrically closest to the new **customer's connection location** at which there is 1 or more such **Appendix A customers**, as determined by **Transpower**, each such **Appendix A customer** being **Appendix A customer j**

BF_j is **Appendix A customer j's benefit factor** for the **Appendix A BBI** and the new **customer's connection location** (or the electrically closest connection location, as the case may be) (which may be zero); and

- (b) scale down all **beneficiaries' (including the new customer's) BBI customer allocations** for the **Appendix A BBI** by a factor (F) calculated as follows:

$$F = \frac{1}{1 + CA}$$

where CA is the new **customer's BBI customer allocation** for the **Appendix A BBI** calculated under paragraph (a); and

- (c) calculate or re-calculate (as the case may be) all **beneficiaries' benefit-based charges** for the **Appendix A BBI** based on the **beneficiaries' BBI customer allocations** calculated under paragraph (b).

- (7) An **Appendix A customer's benefit factor** for an **Appendix A BBI** and **connection location** (BF) is calculated as follows:

$$BF = \frac{CA}{E}$$

where

CA is the part of the **Appendix A customer's Appendix A allocation** for the **Appendix A BBI** attributable to the **connection location** (which may be 0)

E is—

- (a) if the **Appendix A customer** is a **Schedule 1 customer**, and subject to subclause (7A), the **Appendix A customer's average annual offtake** (for a **connected asset owner**) or **injection** (for a **generator**) at the **connection location** over **CMP D**, being the period the **Authority** used to calculate the **Schedule 1 allocations**, adjusted as necessary to take account of any adjustments of the type referred to in subclause 42(2); or
- (b) otherwise, the estimate of the **Appendix A customer's average annual offtake** (for a **connected asset owner**) or **injection** (for a **generator**) at the **connection location** over **CMP D** used to calculate the **Appendix A customer's Appendix A allocation** for the **Appendix A BBI**.

- (7A) This subclause applies to an **Appendix A customer** and **connection location** if—

- (a) paragraph (a) of the definition of variable E in subclause (7) applies to the calculation of the **Appendix A customer's benefit factors** for the **connection location**; and
- (b) the **Appendix A customer**—
- (i) is or was a **connected asset owner** at the **connection location** and had average annual **injection** at the **connection location** over **CMP D** that was greater than its average annual **offtake** at the **connection location** over **CMP D**; or
- (ii) is or was a **generator** at the **connection location** and had average annual **offtake** at a **connection location** over **CMP D** that was greater than its average annual **injection** at the **connection location** over **CMP D**.

If this subclause applies, **Transpower** must—

- (c) if the **Appendix A customer** is or was a **connected asset owner** at the **connection location**—
 - (i) use the **Appendix A customer’s** average annual **injection** at the **connection location** over **CMP D** as the value of variable E in subclause (7), instead of its average annual **offtake** at the **connection location** over **CMP D**; and
 - (ii) treat the **Appendix A customer** as a **generator** at the **connection location** for the purposes of calculations under paragraph (6)(a); and
 - (d) if the **Appendix A customer** is or was a **generator** at the **connection location**—
 - (i) use the **Appendix A customer’s** average annual **offtake** at the **connection location** over **CMP D** as the value of variable E in subclause (7), instead of its average annual **injection** at the **connection location** over **CMP D**; and
 - (ii) treat the **Appendix A customer** as a **connected asset owner** at the **connection location** for the purposes of calculations under paragraph (6)(a).
- (8) For the purposes of the calculation under paragraph (6)(a), if the new **customer’s assets** are **battery storage**—
- (a) the new **customer** must be treated as a **generator** and not a **connected asset owner**; and
 - (b) variable E must be **Transpower’s** estimate of the new **customer’s** average annual **injection** at the new **customer’s connection location** when the new **customer’s battery storage** is fully operational.
- (9) The following tables illustrate the application of subclause (6) to a new **customer (beneficiary E)** for an **Appendix A BBI**, where the incumbent **beneficiaries** are all **Appendix A customers** and the **benefit factors** for **beneficiaries B and C** are used in the calculation in subclause (6)(a):

Before

beneficiary	benefit factor	average annual offtake/injection	BBI customer allocation
A	0.1818	100	18.18%
B	0.1818	200	36.36%
C	0.0909	300	27.27%
D	0.0455	400	18.18%

Transition (paragraph (6)(a))

beneficiary	benefit factor	average annual offtake/injection	BBI customer allocation
A	0.1818	100	18.18%
B	0.1818	200	36.36%
C	0.0909	300	27.27%
D	0.0455	400	18.18%
E	$(0.1818 + 0.0909)/2 = 0.1364$	250 (estimated)	$0.1364 \times 250 = 34.10\%$

After (paragraph (6)(b))

beneficiary	benefit factor	annual offtake/injection	BBI customer allocation (scaled by 1/1.341)
A	0.1818	100	13.56%
B	0.1818	200	27.11%
C	0.0909	300	20.34%
D	0.0455	400	13.56%
E	0.1364	250 (estimated)	25.43%

- (9A) Despite subclause (5B) and paragraph (6)(a), **Transpower** may exclude from the calculation under subclause (5B) or paragraph (6)(a) (as the case may be) any other **customer's generating plant, consuming plant or local network** that is not reasonably comparable to the new **customer's generating plant, consuming plant or local network**, whether by reason of different expected operating modes or otherwise.
- (10) **Transpower** must start the new **customer's monthly benefit-based charges** calculated under paragraph (3)(e) or (6)(c) as soon as reasonably practicable. The new **customer's monthly benefit-based charges** may include an adjustment as necessary to ensure the new **customer** pays its full **benefit-based charge** for each **BBI** from the date the new **customer** connected to the **grid**.
- (11) **Transpower** is not required to (but may) start any other **beneficiary's monthly benefit-based charges** re-calculated under paragraph (3)(e) or (6)(c) during, or from the start of, an **exempt pricing year** for the **beneficiary**. However, any over-recovery of the **benefit-based charge** for a **BBI** and **exempt pricing year** resulting from the start of the new **customer's monthly benefit-based charge** for the **BBI** must be rebated, as appropriate, to the other **beneficiaries** by way of an adjustment to their **transmission charges**—
- (a) if reasonably practicable, at the end of the **exempt pricing year**; or
 - (b) otherwise, as soon as reasonably practicable during the next **pricing year**.
- (12) Subclause (13) applies if the new **customer** is expected to be a member of a **regional customer group** under the **simple method** that—
- (a) had no members during **CMP C** for the relevant **simple method period**; and
 - (b) has **regional NPB** of 0 in respect of at least one **investment region** for the relevant **simple method period** (each a **zero RNPB investment region**).
- (13) If this subclause applies under subclause (12), **Transpower** must, for the purposes of the calculation under paragraph (3)(b), calculate **regional NPB** for the **regional customer group** in respect of each **zero RNPB investment region** (RNPB) as follows:

$$RNPB = \frac{RNPB_{type\ total}}{I \times IRA_{type\ total}} \times IRA \times \frac{RNPB_{inv\ total}}{RNPB_{total}}$$

where, subject to subclause (14)

$RNPB_{type\ total}$ is—

- (a) if the **regional customer group** is a **regional demand group**, the total of all other **regional demand groups' regional NPBs** in respect of all **investment regions** for the **simple method period**; or

- (b) if the **regional customer group** is a **regional supply group**, the total of all other **regional supply groups' regional NPBs** in respect of all **investment regions** for the **simple method period**
- I is the number of **investment regions** for the **simple method period**
- $IRA_{type\ total}$ is—
- (a) if the **regional customer group** is a **regional demand group**, the total of all **customers' intra-regional allocator** values for all other **regional demand groups** for the **simple method period**; or
- (b) if the **regional customer group** is a **regional supply group**, the total of all **customers' intra-regional allocator** values for all other **regional supply groups** for the **simple method period**
- IRA is the value of the **customer's intra-regional allocator** estimated under paragraph 83(3)(a)
- $RNPB_{inv\ total}$ is the total of all other **regional customer groups' regional NPBs** in respect of the **zero RNPB investment region** for which RNPB is being calculated
- $RNPB_{total}$ is the total of all other **regional customer groups' regional NPBs** in respect of all **zero RNPB investment regions**.

- (14) The other **regional customer groups** referred to in the definitions of variables $RNPB_{type\ total}$, $RNPB_{inv\ total}$ and $RNPB_{total}$ in subclause (13) exclude **regional customer groups** with no members.

Clause 83(3)(a)(ii): amended, on 10 April 2024, by clause 5(1) of the Electricity Industry Participation Code Amendment (Benefit-based Charge Adjustment Event: New Customer) 2024.

Clause 83(5): amended, on 10 April 2024, by clause 5(2) of the Electricity Industry Participation Code Amendment (Benefit-based Charge Adjustment Event: New Customer) 2024.

Clause 83(5A), (5B) and (5C): inserted, on 10 April 2024, by clause 5(3) of the Electricity Industry Participation Code Amendment (Benefit-based Charge Adjustment Event: New Customer) 2024.

Clause 83(6)(a): amended, on 10 April 2024, by clause 5(4) of the Electricity Industry Participation Code Amendment (Benefit-based Charge Adjustment Event: New Customer) 2024.

Clause 83(7): amended, on 31 July 2023, by clause 18 of the Electricity Industry Participation Code Amendment (Transmission Pricing Methodology Amendments) 2023.

Clause 83(7A): inserted, on 31 July 2023, by clause 18 of the Electricity Industry Participation Code Amendment (Transmission Pricing Methodology Amendments) 2023.

Clause 83(9A): inserted, on 10 April 2024, by clause 5(5) of the Electricity Industry Participation Code Amendment (Benefit-based Charge Adjustment Event: New Customer) 2024.

84 Benefit-based Charge Adjustment Event: Exiting Customer

- (1) This clause 84 applies in the case of the **benefit-based charge adjustment event** in paragraph 81(1)(c).
- (2) The exiting **customer** ceases to be a **beneficiary** of each **BBI** (a relevant **BBI**) of which the exiting **customer** was a **beneficiary** immediately before ceasing to be a **customer**.

- (3) Subject to subclause (7), **Transpower**—
- (a) must, for each relevant **BBI**—
- (i) make the exiting **customer's BBI customer allocation** and **benefit-based charge** for the relevant **BBI** 0; and
 - (ii) scale up all remaining **beneficiaries' BBI customer allocations** for the relevant **BBI** by a factor (F) calculated as follows:

$$F = \frac{1}{1 - CA}$$

where CA is the exiting **customer's BBI customer allocation** for the relevant **BBI** immediately before it was set to 0 under subparagraph (i); and

- (iii) re-calculate all remaining **beneficiaries' benefit-based charges** for the relevant **BBI** based on the remaining **beneficiaries' BBI customer allocations** calculated under subparagraph (ii); and
- (b) must not increase—
- (i) the remaining **beneficiaries' benefit-based charges** for the relevant **BBI** and **event pricing year**; or
 - (ii) any other **transmission charges** for the **event pricing year**, as a consequence of applying subparagraph (a)(i).
- (4) The following tables illustrate the application of subclause c to a **customer (customer D)** exiting **regional customer group Y** for a **post-2019 BBI** that is not a **resiliency BBI**:

Before

regional customer group	beneficiary	regional NPB	intra-regional allocator	individual NPB	BBI customer allocation
X	A	60	1	20	16.67%
	B		2	40	33.33%
Y	C	50	3	30	25.00%
	D		2	20	16.67%
	E		1	10	8.33%

After (subparagraphs (3)(a)(i) and (3)(a)(ii))

regional customer group	beneficiary	regional NPB	intra-regional allocator	individual NPB	BBI customer allocation (scaled by 1/0.8333)
X	A	60	1	20	20.00%
	B		2	40	40.00%
Y	C	50	3	30	30.00%
	D		2	20	0%
	E		1	10	10.00%

- (5) In subclauses (6) and (7), a **continuing BBI** is the Bunnythorpe Haywards **Appendix A BBI** or a **post-2019 BBI**—
- (a) of which the exiting **customer** was a **beneficiary** immediately before ceasing to be a **customer**; and
 - (b) in the case of the Bunnythorpe Haywards **Appendix A BBI** or a **post-2019 BBI** under a **standard method**, **commissioned** less than 10 years before the date the exiting **customer** ceased to be a **customer**; and
 - (c) in the case of a **post-2019 BBI** under the **simple method**, **commissioned** during a **simple method period** that started less than 12.5 years before the date the exiting **customer** ceased to be a **customer**.
- (6) Subclause (7) applies to a **continuing BBI** until—
- (a) in the case of the Bunnythorpe Haywards **Appendix A BBI** or a **post-2019 BBI** under a **standard method**, the start of the first **pricing year** that starts at least 10 years after the **continuing BBI's commissioning date**; and
 - (b) in the case of a **post-2019 BBI** under the **simple method**, the start of the **first pricing year** that starts at least 12.5 years after the start of the **simple method period** during which the **continuing BBI** was **commissioned**.
- (7) If this subclause applies to a **continuing BBI** under subclause (6) and a **related entity** of the exiting **customer** is a **customer** after the exiting **customer** ceases to be a **customer**—
- (a) subparagraphs (3)(a)(ii) and (3)(a)(iii) do not apply; and
 - (b) the exiting **customer's benefit-based charge** for the **continuing BBI** must be attributed (by way of increase) to the **related entity** in its capacity as a **customer**. If there is more than 1 **related entity**, this subclause applies to a **related entity** determined by **Transpower**; and
 - (c) **Transpower** must start the **related entity's monthly benefit-based charges** attributed under paragraph (b) as soon as reasonably practicable. The **related entity's monthly benefit-based charges** may include an adjustment as necessary to ensure the **related entity** pays its full attributed **benefit-based charge** for the **continuing BBI** from the date the exiting **customer** ceased to be a **customer**.

85 Benefit-based Charge Adjustment Event: Large Plant Connected or Disconnected

- (1) Subject to subclause 81(6), this clause 85 applies in the case of the **benefit-based charge adjustment event** in paragraph 81(1)(d) or 81(1)(e).
- (2) **Transpower** must, for a connecting **customer**—
- (a) comply with clause 83 as if the **large plant** had been connected to the **grid** by a separate new **customer** (the notional new **customer**) at—
 - (i) if the **large plant** is connected to the **grid**, the **connection location** where the **large plant** is connected; or
 - (ii) if the **large plant** is connected to the connecting **customer's local network**, the **connection location** electrically closest to the **large plant's** electrically closest **point of connection** to the **local network**, as determined by **Transpower**; or
 - (iii) if the **large plant** is connected to the connecting **customer's grid-connected plant**, the **connection location** where the **grid-connected plant** is connected; and
 - (b) attribute (by way of increase) the notional new **customer's BBI customer allocation** (and the inputs to its calculation) and **benefit-based charge** for each relevant **post-2019 BBI** and **Appendix A BBI** to the connecting **customer**.

- (3) Subject to subclause (6), **Transpower** must, for a disconnecting **customer**—
- (a) comply with clause 84 (without regard to subclauses 84(5) to 84(7)) as if the **large plant** had been disconnected from the **grid** by a separate exiting **customer** (the notional exiting **customer**) at—
 - (i) if the **large plant** was connected to the **grid**, the **connection location** where the **large plant** was connected; or
 - (ii) if the **large plant** was connected to the disconnecting **customer's local network**, the **connection location** electrically closest to the **large plant's** electrically closest **point of connection** to the **local network** before the **large plant** was disconnected, as determined by **Transpower**; or
 - (iii) if the **large plant** was connected to the disconnecting **customer's grid-connected plant**, the **connection location** where the **grid-connected plant** is connected; and
 - (b) attribute (by way of reduction) the notional exiting **customer's BBI customer allocation** (and the inputs to its calculation) and **benefit-based charge** for each relevant **BBI** to the disconnecting **customer**, provided that the minimum value of the disconnecting **customer's BBI customer allocation** (and the inputs to its calculation) and **benefit-based charge** for each relevant **BBI** is 0.
- (4) In subclauses (5) and (6), a **continuing BBI** is the Bunnythorpe Haywards **Appendix A BBI** or a **post-2019 BBI**—
- (a) of which the notional exiting **customer** was a **beneficiary** immediately before the disconnection of the **large plant**; and
 - (b) in the case of the Bunnythorpe Haywards **Appendix A BBI** or a **post-2019 BBI** under a **standard method**, **commissioned** less than 10 years before the date the **large plant** was disconnected; and
 - (c) in the case of a **post-2019 BBI** under the **simple method**, **commissioned** during a **simple method period** that started less than 12.5 years before the date the **large plant** was disconnected.
- (5) Subclause (6) applies to a **continuing BBI** until—
- (a) in the case of the Bunnythorpe Haywards **Appendix A BBI** or a **post-2019 BBI** under a **standard method**, the start of the first **pricing year** that starts at least 10 years after the **continuing BBI's commissioning date**; and
 - (b) in the case of a **post-2019 BBI** under the **simple method**, the start of the **first pricing year** that starts at least 12.5 years after the start of the **simple method period** during which the **continuing BBI** was **commissioned**.
- (6) If this subclause applies to a **continuing BBI** under subclause (5) and the **large plant** owner or a **related entity** of the **large plant** owner (relevant person) is a **customer** after the disconnection of the **large plant**—
- (a) subparagraphs 84(3)(a)(ii) and 84(3)(a)(iii) do not apply; and
 - (b) the notional exiting **customer's benefit-based charge** for the **continuing BBI** must be attributed (by way of increase) to the relevant person in its capacity as a **customer**. If there is more than 1 relevant person, this subclause applies to—
 - (i) the **large plant** owner; or
 - (ii) if the **large plant** owner is not a **customer** after the disconnection of the **large plant**, a **related entity** determined by **Transpower**; and
 - (c) **Transpower** must start the relevant person's **monthly benefit-based charges** attributed under paragraph (b) as soon as reasonably practicable. The relevant person's **monthly benefit-based charges** may include an adjustment as necessary to ensure the relevant

person pays its full attributed **benefit-based charge** for the **continuing BBI** from the date the **large plant** was disconnected.

86 Benefit-based Charge Adjustment Event: Substantial Sustained Increase

- (1) This clause 86 applies in the case of the **benefit-based charge adjustment event** in paragraph 81(1)(f) or 81(1)(g).
- (2) **Transpower** must—
 - (a) comply with clause 83 as if the **substantial sustained increase** were attributable to **plant** connected to the **grid** by a separate new **customer** (the notional new **customer**) at—
 - (i) if the **substantial sustained increase** is in **electricity** consumed or generated by **grid-connected plant**, the **connection location** where the **grid-connected plant** is connected; or
 - (ii) if the **substantial sustained increase** is in **electricity** consumed or generated by **large embedded plant** connected to the increasing **customer's local network**, the **connection location** electrically closest to the **large embedded plant's** electrically closest **point of connection** to the **local network**, as determined by **Transpower**; or
 - (iii) if the **substantial sustained increase** is in **electricity** consumed or generated by **large embedded plant** connected to the increasing **customer's grid-connected plant**, the **connection location** where the **grid-connected plant** is connected; and
 - (b) attribute the notional new **customer's BBI customer allocation** (and the inputs to its calculation) and **benefit-based charge** for each relevant **post-2019 BBI** and **Appendix A BBI** to the increasing **customer**.

87 Benefit-based Charge Adjustment Event: Distributor Connection at Grid Point of Connection

- (1) This clause 87 applies in the case of the **benefit-based charge adjustment event** in paragraph 81(1)(h).
- (2) In this clause 87, a relevant **BBI** is a **BBI** that has at least 1 **regional customer group** with positive **regional NPB** that the connecting **distributor** became a member of by connecting at the new **grid point of connection** (and of which the connecting **distributor** was not a member immediately before connecting at the new **grid point of connection**).
- (3) **Transpower** must for each relevant **BBI** (and no other **BBIs**)—
 - (a) comply with clause 83 as if a **local network** had been connected at the new **grid point of connection** by a separate new **distributor** (the notional new **distributor**), provided that the estimate of the notional new **distributor's intra-regional allocators** must take into account any expected reduction in the connecting **distributor's offtake** or **injection at grid points of connection** in other **modelled regions** as a result of the connection of the connecting **customer's local network** at the new **grid point of connection** (with any such reduction to be set off against the estimate of the notional new **distributor's offtake** or **injection at the new grid point of connection**); and
 - (b) attribute the notional new **distributor's BBI customer allocation** (and the inputs to its calculation) and **benefit-based charge** for each relevant **BBI** to the connecting **distributor**.

Clause 87 Heading: amended, on 31 July 2023, by clause 19 of the Electricity Industry Participation Code Amendment (Transmission Pricing Methodology Amendments) 2023.

88 Benefit-based Charge Adjustment Event: Changed Point of Connection

- (1) This clause 88 applies in the case of the **benefit-based charge adjustment event** in paragraph 81(1)(i).
- (2) **Transpower** must—
 - (a) apply subclauses 85(2) and 85(3) to calculate the notional new **customer's** and notional exiting **customer's BBI customer allocations**; and
 - (b) identify the **BBIs** of which both the notional new **customer** and notional exiting **customer** are **beneficiaries** (the relevant **BBIs**).
- (3) If the notional new **customer's BBI customer allocation** for a relevant **BBI** is equal to or more than the notional exiting **customer's BBI customer allocation** for the relevant **BBI**, **Transpower** must—
 - (a) apply paragraph 85(2)(b) for the connecting **customer** and relevant **BBI**; and
 - (b) apply paragraph 85(3)(b) for the disconnecting **customer** and relevant **BBI** (without regard to subclause 85(5)).
- (4) If the notional exiting **customer's BBI customer allocation** for a relevant **BBI** is more than the notional new **customer's BBI customer allocation** for the relevant **BBI**, **Transpower** must—
 - (a) apply paragraph 85(2)(b) for the connecting **customer** and relevant **BBI**, but by attributing to the connecting **customer** the notional exiting **customer's BBI customer allocation** (and the inputs to its calculation) and **benefit-based charge** for the relevant **BBI** instead of the notional new **customer's**; and
 - (b) apply paragraph 85(3)(b) for the disconnecting **customer** and relevant **BBI** (without regard to subclause 85(5)).

89 Benefit-based Charge Adjustment Event: Sale of Business

- (1) This clause 89 applies in the case of the **benefit-based charge adjustment event** in paragraph 81(1)(j).
- (2) **Transpower** must, for a sale of part of the vendor's business—
 - (a) determine an apportionment between the vendor and purchaser of the vendor's **BBI customer allocation** (and the inputs to its calculation) for the **BBI** taking into account the size and nature of the transferred business; and
 - (b) calculate or re-calculate (as the case may be) the vendor's and purchaser's **benefit-based charges** for the **BBI** based on the apportionment of the vendor's **BBI customer allocation** under paragraph (a); and
 - (c) calculate or re-calculate (as the case may be) the vendor's and purchaser's **cap recovery charge** and **prudent discount recovery charges** for the **event pricing year** to account for—
 - (i) the vendor's and purchaser's **annual benefit-based charges** calculated under paragraph (b); and
 - (ii) any **annual residual charge** for the vendor or purchaser calculated under subclause 94(2) or 94(3) in respect of the same sale of business.

- (3) **Transpower** must, for a sale of all of the vendor's business—
- (a) attribute the vendor's **BBI customer allocation** (and the inputs to its calculation) for the **BBI** to the purchaser; and
 - (b) calculate or re-calculate (as the case may be) the purchaser's **benefit-based charge** for the **BBI** based on the attribution of the vendor's **BBI customer allocation** under paragraph (a); and
 - (c) calculate or re-calculate (as the case may be) the purchaser's **cap recovery charge** and **prudent discount recovery charges** for the **event pricing year** to account for—
 - (i) the purchaser's **annual benefit-based charge** calculated under paragraph (b); and
 - (ii) any **annual residual charge** for the vendor or purchaser calculated under clause 94(2) or 94(3) in respect of the same sale of business.
- (4) **Transpower** must start the purchaser's **monthly benefit-based charge** calculated under paragraph (2)(b) or (3)(b) as soon as reasonably practicable. The purchaser's **monthly benefit-based charge** may include an adjustment as necessary to ensure the purchaser pays its full **benefit-based charge** for the **BBI** from the date of the transfer.
- (5) **Transpower** is not required to (but may) start the vendor's **monthly benefit-based charge** calculated under paragraph (2)(b) during, or from the start of, an **exempt pricing year** for the vendor. However, any over-recovery of the **annual benefit-based charge** for the **BBI** and **exempt pricing year** resulting from the start of the purchaser's **monthly benefit-based charge** for the **BBI** must be rebated to the vendor by way of an adjustment to its **transmission charges**—
- (a) if reasonably practicable, at the end of the **exempt pricing year**; or
 - (b) otherwise, as soon as reasonably practicable during the next **pricing year**.

90 Benefit-based Charge Adjustment Event: Voluntary Under-recovery

- (1) This clause 90 applies in the case of the **benefit-based charge adjustment event** in paragraph 81(1)(k).
- (2) In this clause 90, a relevant **pricing year** is a **pricing year** for which **Transpower** decided to voluntarily under-recover the **BBI's covered cost**.
- (3) **Transpower** must, for each relevant **pricing year**, calculate or re-calculate (as the case may be) all **beneficiaries' benefit-based charges** for the **BBI** to account for the amount of the voluntary under-recovery of the **BBI's covered cost**.
- (4) If **Transpower** decides to voluntarily under-recover the **BBI's covered cost** for a relevant **pricing year** during, or within 1 month of the start of, the relevant **pricing year**, **Transpower** is not required to (but may) start **beneficiaries' monthly benefit-based charges** calculated under subclause (3) during, or from the start of, the relevant **pricing year**. However, any over-recovery of the **BBI's covered cost** for the relevant **pricing year** (accounting for the voluntary under-recovery) must be rebated, as appropriate, to the **beneficiaries** by way of an adjustment to their **transmission charges**—
- (a) if reasonably practicable, at the end of the relevant **pricing year**; or
 - (b) otherwise, as soon as reasonably practicable during the next **pricing year**.

91 Benefit-based Charge Adjustment Event: SSCGU

- (1) This clause 91 applies in the case of the **benefit-based charge adjustment event** in paragraph 81(1)(l).

- (2) **Transpower** must—
- (a) determine which **post-2019 BBIs**, if any, satisfy all of the following conditions (the relevant **BBIs**):
 - (i) the **post-2019 BBI** is expected to be **high-value** at the start of the **SSCGU's start pricing year**;
 - (ii) the distribution of **regional NPB** for the **post-2019 BBI** is likely to have changed materially as a result of the **SSCGU**, compared to the distribution of **regional NPB** for the **post-2019 BBI** immediately before the **SSCGU**;
 - (iii) the **SSCGU** was not a **market scenario** used to calculate the existing **BBI customer allocations** for the **post-2019 BBI**; and
 - (b) for each relevant **BBI**, re-calculate **beneficiaries' BBI customer allocations** as if the relevant **BBI** were a new **high-value post-2019 BBI** for which—
 - (i) the **standard method calculation period** starts on the date of the **SSCGU**; and
 - (ii) the **final investment decision date** is the date of the **SSCGU**.
- (3) In carrying out the re-calculation under paragraph b.ii, **Transpower** may use—
- (a) a different **standard method** than was used to calculate the existing **BBI customer allocations** for the relevant **BBI**; or
 - (b) different **factual, counterfactual, investment grids, system limits, scenarios, modelled regions** and **regional customer groups** than were used to calculate the existing **BBI customer allocations** for the relevant **BBI**.
- (4) From the **SSCGU's start pricing year**, **Transpower** must calculate **beneficiaries' benefit-based charges** for each relevant **BBI** based on the **beneficiaries' BBI customer allocations** for the relevant **BBI** re-calculated under paragraph (2)(b).

Residual Charges

92 Residual Charge Adjustment Events

- (1) The following events are **residual charge adjustment events**:
- (a) a **customer** (the exiting **load customer**) ceases to be a **customer**;
 - (b) a **customer** (the vendor) sells or otherwise transfers all or part of its business that constitutes it as a **load customer** to another party (the purchaser);
 - (c) **Transpower** decides to voluntarily under-recover **residual revenue**.
- (2) **Transpower** must not voluntarily under-recover **residual revenue** for a **pricing year** if the effect of doing so would be to increase **residual revenue** for any other **pricing year**.
- (3) To avoid doubt, a vendor's sale or other transfer of all or part of its business that constitutes it as a **load customer** to a purchaser is treated as the **residual charge adjustment event** in paragraph (1)(b) and not the **residual charge adjustment event** in paragraph (1)(a), and the purchaser is not treated as a new **load customer**.

93 Residual Charge Adjustment Event: Exiting Load Customer

- (1) This clause 93 applies in the case of the **residual charge adjustment event** in paragraph 92(1)(a).
- (2) **Transpower**—
- (a) must make the exiting **load customer's AMDR** and **residual charge 0**; and
 - (b) must not increase—
 - (i) any other **load customer's residual charge** for the **event pricing year**; or
 - (ii) any other **transmission charges** for the **event pricing year**, as a consequence of applying paragraph (a).

94 Residual Charge Adjustment Event: Sale of Business

- (1) This clause 94 applies in the case of the **residual charge adjustment event** in paragraph 92(1)(b).
- (2) **Transpower** must, for a sale of part of the vendor's business—
 - (a) determine an apportionment between the vendor and purchaser of the vendor's **AMDR** (and the inputs to its calculation) taking into account the size and nature of the transferred business; and
 - (b) calculate or re-calculate (as the case may be) the vendor's and purchaser's **residual charges** based on the apportionment of the vendor's **AMDR** under paragraph (a) (but not any change in **residual revenue** that may have occurred during the **event pricing year**); and
 - (c) calculate or re-calculate (as the case may be) the vendor's and purchaser's **cap recovery charge** and **prudent discount recovery charges** for the **event pricing year** to account for—
 - (i) the vendor's and purchaser's **annual residual charges** calculated under paragraph (b); and
 - (ii) any **annual benefit-based charges** for the vendor or purchaser calculated under subclause 89(2) or 89(3) in respect of the same sale of business.
- (3) **Transpower** must, for a sale of all of the vendor's business—
 - (a) attribute the vendor's **AMDR** (and the inputs to its calculation) to the purchaser; and
 - (b) calculate or re-calculate (as the case may be) the purchaser's **residual charge** based on the attribution of the vendor's **AMDR** under paragraph (a); and
 - (c) calculate or re-calculate (as the case may be) the purchaser's **cap recovery charge** and **prudent discount recovery charges** for the **event pricing year** to account for—
 - (i) the purchaser's **annual residual charges** calculated under paragraph (b); and
 - (ii) any **annual benefit-based charges** for the vendor or purchaser calculated under subclause 89(2) or 89(3) in respect of the same sale of business.
- (4) **Transpower** must start the purchaser's **monthly residual charge** calculated under paragraph (2)(b) or (3)(b) as soon as reasonably practicable. The purchaser's **monthly residual charge** may include an adjustment as necessary to ensure the purchaser pays its full **residual charge** from the date of the transfer.
- (5) **Transpower** is not required to (but may) start the vendor's **monthly residual charge** calculated under paragraph (2)(b) during, or from the start of, an **exempt pricing year** for the vendor. However, any over-recovery of **residual revenue** for the **exempt pricing year** resulting from the start of the purchaser's **monthly residual charge** must be rebated to the vendor by way of an adjustment to its **transmission charges**—
 - (a) if reasonably practicable, at the end of the **exempt pricing year**; or
 - (b) otherwise, as soon as reasonably practicable during the next **pricing year**.

95 Residual Charge Adjustment Event: Voluntary Under-recovery

- (1) This clause 95 applies in the case of the **residual charge adjustment event** in paragraph 92(1)(c).
- (2) In this clause 95, a relevant **pricing year** is a **pricing year** for which **Transpower** decided to voluntarily under-recover **residual revenue**.

- (3) **Transpower** must, for each relevant **pricing year**, calculate or re-calculate (as the case may be) all **load customers' residual charges** for the discounted **pricing year** to account for the amount of the voluntary under-recovery of **residual revenue**.
- (4) If **Transpower** decides to voluntarily under-recover **residual revenue** for a relevant **pricing year** during, or within 1 month of the start of, the relevant **pricing year**, **Transpower** is not required to (but may) start **load customers' monthly residual charges** calculated under subclause (3) during, or from the start of, the relevant **pricing year**. However, any over-recovery of **residual revenue** for the relevant **pricing year** (accounting for the voluntary under-recovery) must be rebated, as appropriate, to **load customers** by way of an adjustment to their **transmission charges**—
- (a) if reasonably practicable, at the end of the relevant **pricing year**; or
 - (b) otherwise, as soon as reasonably practicable during the next **pricing year**.

Part G Reassignment

96 Effect of Reassignment

If an **eligible BBI** is **reassigned**, **Transpower** must, from the **reassignment's start pricing year**—

- (a) reduce the **eligible BBI's covered cost** by the **eligible BBI's reassignment amount**; and
- (b) calculate **beneficiaries' benefit-based charges** for the **eligible BBI** based on the reduction of the **eligible BBI's covered cost** under paragraph (a).

97 Reassignment Amount

The **reassignment amount** for a **reassigned eligible BBI (RA)** is calculated as follows:

$$RA = CC \times (1 - RF)$$

where

CC is the **eligible BBI's covered cost**

RF is the **eligible BBI's reassignment factor**.

98 Eligibility for Reassignment

(1) Before or as soon as reasonably practicable after the start of a **pricing year**, **Transpower** must **publish**—

- (a) a list of **BBIs** that satisfy paragraph (a) of the definition of **eligible BBI** in clause 3 as at the start of the **pricing year**; and
- (b) identify which of the listed **BBIs** are **post-2019 BBIs** that satisfy subparagraph (b)(i) of the definition of **eligible BBI** in clause 3 as at the start of the **pricing year**.

(2) The **reassignment threshold (RT)** for a **pricing year** is—

- (a) \$5m for the **first pricing year**; and
- (b) calculated as follows for each **pricing year** after the **first pricing year**:

$$RT = \$5m \times \frac{CPI}{CPI_{base}}$$

where

CPI is the average of the quarterly **CPIs** for the preceding **financial year**

CPI_{base} is the average of the quarterly **CPIs** for the most recent complete **financial year** before the start of the **first pricing year**.

(3) If there is a base adjustment to **CPI**, the calculation in paragraph (2)(b) is to include an equivalency adjustment to eliminate the impact of the base adjustment.

99 Reassignment Application

(1) If an **eligible person** wishes for a **BBI** to be **reassigned**, the **eligible person** must submit to **Transpower** a written **application for reassignment** that meets the requirements of subclause (2).

- (2) An **application for reassignment** must—
 - (a) contain all of the information described in the relevant **application requirements**; and
 - (b) contain reasonable evidence that the conditions for **reassignment** in this **transmission pricing methodology** are met; and
 - (c) be accompanied by an **independent verification** of the **application**.
- (3) The **eligible person** must provide **Transpower** with any additional information **Transpower** determines is necessary to enable it to assess the **application**.

100 Application Screening and Publication

- (1) **Transpower** must reject an **application for reassignment** without assessing the **application** further if, when **Transpower** receives the **application**—
 - (a) the applicant is not an **eligible person**; or
 - (b) the **BBI** to which the **application** relates is not an **eligible BBI**.
- (2) **Transpower** may reject an **eligible person's application for reassignment** without assessing the **application** further—
 - (a) under subclause 14(1); or
 - (b) if an **eligible person** has previously applied for **reassignment** on substantially the same basis as the new **application** and **Transpower**—
 - (i) rejected the previous **application**; and
 - (ii) determines there has not been a change in circumstances since its decision on the previous **application** that materially increases the likelihood of the new **application** being approved.
- (3) **Transpower** is not required to consult on any decision to reject an **application** under subclause (1), (2) or 14(1).
- (4) Unless **Transpower** rejects an **application** under subclause (1), (2) or 14(1), and subject to clause 106, **Transpower** must **publish** the **application** and any information the **eligible person** provides to **Transpower** under subclause 99c.

101 Assessment

- (1) In assessing an **eligible person's application for reassignment**, **Transpower**—
 - (a) is not obliged to use the information the **eligible person** provided in or in support of the **application**; and
 - (b) may use any other information relevant to the **application**.
- (2) **Transpower** must approve the **application** if **Transpower** determines that—
 - (a) the **eligible BBI** to which the **application** relates has a **BBI reassignment factor** of less than 0.8; and
 - (b) the circumstances causing the **BBI reassignment factor** to be less than 0.8—
 - (i) are reasonably likely to persist for at least 5 years after they occurred; and
 - (ii) have not resulted, and are not reasonably likely to result, in a **write-down** of assets comprised in the **BBI**.
- (3) Otherwise, **Transpower** must reject the **application**.

102 Forecast Peak Loading and Reassignment Factors

- (1) The **forecast loading period** for an **eligible BBI** the subject of a **reassignment** application is the period starting on the date **Transpower** receives the application and ending on the later of—
 - (a) 10 years after the date **Transpower** receives the application; and

- (b) if the **eligible BBI** is a **post-2019 BBI** to which subparagraph (b)(i) of the definition of **eligible BBI** in clause 3 does not apply, 20 years after the **eligible BBI's commissioning date**.
- (2) **Forecast peak loading** for a **transmission investment** comprised in the **eligible BBI** is the expected future peak electrical loading of the **transmission investment** over the **eligible BBI's forecast loading period**, as determined by **Transpower**.
- (3) The **investment reassignment factor** for a **transmission investment** comprised in the **eligible BBI** is the proportion of the **transmission investment's total replacement cost** (adjusted proportionately for any previous **write-down** of assets comprised in the **transmission investment**) **Transpower** determines it would incur to replace the **transmission investment** with a **transmission investment**—
- (a) of the same type; and
- (b) with a service potential sufficient to meet the **forecast peak loading** and reasonable **grid contingencies**, but no more.
- (4) The **BBI reassignment factor** for the **eligible BBI** (BRF) is calculated as follows:

$$BRF = \frac{1}{CC_{total}} \sum_i (CC_i \times IRF_i)$$

where

CC_{total} is the **eligible BBI's covered cost** for the **pricing year** during which the application for **reassignment** was received

CC_i is the part of the **eligible BBI's covered cost** for the **pricing year** during which the application for **reassignment** was received attributable to **transmission investment i**, where **transmission investment i** is a **transmission investment** comprised in the **eligible BBI**

IRF_i is **transmission investment i's investment reassignment factor**.

- (5) **Transpower** may **publish** in the **reassignment practice manual**, for 1 or more types of **transmission investment** in, or in relation to, **interconnection assets**, information about the relationship between the **transmission investment's forecast peak loading** and its **investment reassignment factor**, which may include 1 or more methods of calculating the **investment reassignment factor** as a function of **forecast peak loading**.

103 Consultation on Draft Decision

- (1) Subject to subclause 100(3), **Transpower** must consult with all **customers** on its draft decision to approve or reject an **eligible person's application** for **reassignment**.
- (2) Subject to clause 106, **Transpower's** consultation under subclause (1) must include the information specified in paragraphs 105(a), 105(b) and 105(c) for the draft decision.

104 Decision and Independent Review

- (1) If **Transpower** decides to approve an **eligible person's application** for **reassignment**, **Transpower** may approve a different **BBI reassignment factor** than sought in the **application**.

- (2) **Transpower** must notify the **eligible person** whether **Transpower** approves or rejects the **application**. **Transpower's** notice must include the information specified in paragraphs 105(a), 105(b) and 105(c).
- (3) The **eligible person** may, within 60 days of **Transpower** notifying the **eligible person** of **Transpower's** decision on the **application**, refer any aspect of **Transpower's** decision to an **independent expert** for review.
- (4) The **independent expert's** decision will be binding on **Transpower** and the **eligible person**, and will have effect as if **Transpower** had made the decision itself, except that the **eligible person** may not refer the decision to an **independent expert** again.
- (5) The costs of the **independent expert** must be met by the **eligible person** unless the **independent expert** decides an aspect of **Transpower's** decision under review was unreasonable, in which case **Transpower** may be required to meet all or some of the costs of the **independent expert**, as determined by the **independent expert**.

105 Decision to be Published

Subject to clause 106, as soon as reasonably practicable after the **reassignment confirmation date**, **Transpower** must **publish**—

- (a) its decision to approve or reject the **eligible person's application** for **reassignment**; and
- (b) if **Transpower** approves the **application**, the **eligible BBI** and its **BBI reassignment factor**; and
- (c) **Transpower's** analysis supporting its decision, including any material departures from the assumptions and methodologies in the **reassignment practice manual** and the reasons for those departures; and
- (d) any report prepared by an **independent expert** relating to the **reassignment**.

106 Commercially Sensitive Information

- (1) Subject to subclause (2), **Transpower** is not obliged to **publish** or otherwise disclose any information under subclause 100(4) or 103(2) or clause 105 if—
 - (a) the **eligible person** identifies the information as commercially sensitive; and
 - (b) **Transpower** determines the disclosure of the information would be likely to commercially disadvantage the **eligible person** or any other person, in a material manner.
- (2) **Transpower** must always **publish** under subclause 103(2) and clause 105 at least—
 - (a) its draft decision or decision (as the case may be) to approve or reject the **eligible person's application** for **reassignment**; and
 - (b) if the **application** is approved, the **eligible BBI** and its **BBI reassignment factor**.

107 Reversal for Increased Forecast Peak Loading

- (1) **Transpower** must fully or partially reverse a **reassignment** if—
 - (a) **Transpower** determines that the **forecast peak loading** of 1 or more of the **transmission investments** comprised in the relevant **BBI** have increased such that the **BBI's BBI reassignment factor** has increased; and
 - (b) **Transpower** determines that the circumstances causing the **BBI reassignment factor** to have increased are reasonably likely to persist for at least 5 years after they occurred; and
 - (c) at the time of the reversal, the total **closing RAB value** of all assets comprised in the **BBI** for the most recent complete **financial year** is at least the **reassignment threshold**.
- (2) If **Transpower** proposes to fully or partially reverse the **reassignment**—
 - (a) clause 103 applies as if that clause applied to **Transpower's** draft decision to reverse the **reassignment**;
 - (b) **Transpower** must **publish** its decision on the reversal, including—

- (i) the **BBI's new BBI adjustment factor**; and
 - (ii) **Transpower's** analysis supporting its decision, including any material departures from the assumptions and methodologies in the **reassignment practice manual** and the reasons for those departures; and
 - (c) an **eligible person** for the **BBI** may, within 60 days of **Transpower** publishing its decision on the reversal, refer any aspect of **Transpower's** decision to an **independent expert** for review, in which cases subclauses 104(4) and 104(5) will apply; and
 - (d) clauses 105 and 106 apply as if those clauses applied to **Transpower's** decision on the reversal and the **eligible person** referred to in paragraph 106(1)(a) were any **eligible person** who referred **Transpower's** decision to an **independent expert** under paragraph (c).
- (3) If **Transpower** determines that the **BBI's BBI reassignment factor** is 0.8 or more, **Transpower** must fully reverse the **reassignment**.
- (4) To avoid doubt, all references to the **BBI's BBI reassignment factor** in this clause 107 refer to the **BBI reassignment factor** calculated by reference to the **replacement costs** of the **transmission investments** comprised in the **BBI** without any adjustment for their **investment reassignment factors** for the current **reassignment** of the **BBI**.
- (5) A full or partial reversal of **reassignment** under this clause 107 will have effect from the first **pricing year** that starts at least 6 months (or such shorter period as **Transpower** may determine is practicable) after the **reassignment confirmation date**.

108 Reversal for Subsequent Write-Down

- (1) **Transpower** must fully reverse a **reassignment** if the circumstances causing the relevant **BBI reassignment factor** to be less than 0.8 result in a **write-down** of assets comprised in the relevant **BBI**.
- (2) A reversal of **reassignment** under subclause (1) will have effect from the first **pricing year** that starts after the end of the **financial year** during which the **write-down** occurred.

109 Application Fees, Application Requirements and Reassignment Practice Manual

- (1) **Transpower** must **publish** the **application requirements** and the **application fees**, if any, for **reassignment applications** by the start of the **first pricing year**. **Transpower** may **publish** updates to the **application requirements** and **application fees** from time to time.
- (2) **Transpower** may from time to time **publish**, and **publish** updates to, a **reassignment practice manual**.
- (3) The **reassignment practice manual** must not contain any assumptions or methodologies that are inconsistent with this Code.
- (4) Subject to subclause (5), **Transpower** must consult with all **customers** on the **reassignment practice manual** or any update to it before **publishing** the **reassignment practice manual** or update.
- (5) **Transpower** is not required to consult on an update to the **reassignment practice manual** if **Transpower** determines—
- (a) the update is technical and non-controversial; or
 - (b) there is widespread support for the update among **customers**; or
 - (c) there has been adequate prior consultation on the update so that all relevant views of **customers** have been considered.
- (6) The **reassignment practice manual** is not binding on **Transpower** or any **independent expert**.

- (7) **Transpower** must review the content of the **reassignment practice manual** and consider whether any of the content is appropriate for incorporation in this **transmission pricing methodology** by way of a review under clause 12.85 of this Code no later than 7 years after its date of **publication** and, after that, at intervals of no more than 7 years.
- (8) The **reassignment practice manual** may be part of the same document in which the **assumptions book** or **prudent discount practice manual** is contained.

Part H Transitional Price Cap

110 Cap and Cap Condition

(1) Despite anything else in this **transmission pricing methodology**, a **capped customer's transmission charges** for each **pricing year** preceding **pricing year 2038** must be reduced by the minimum amount necessary (if any) to ensure the **cap condition** is satisfied for the **capped customer** and **pricing year**.

(2) The **cap condition** for a **pricing year** is:

$$CC - IC_{19} - HVDC_{19} \leq DC$$

where

CC is a **capped customer's capped charges** for the **pricing year**

IC₁₉ is the **capped customer's** annual interconnection charge for **pricing year 2019** under the **previous transmission pricing methodology**

HVDC₁₉ is the **capped customer's** annual HVDC charge for **pricing year 2019** under the **previous transmission pricing methodology**

DC is the **capped customer's difference cap** for the **pricing year**.

(3) The **cap condition** is applied, and the **difference cap** is calculated, subject to any applicable **prudent discount** or **previous discount** that applies or applied at the relevant time.

(4) *[Revoked]*

(5) The **cap condition** applies at the start of a **pricing year** only. The **cap condition** is not applied again, and **difference caps** are not re-calculated, if there is an adjustment to **transmission charges** during the **pricing year**.

(6) Despite anything else in this clause 110, the **cap condition** must not result in **Transpower** recovering less than **recoverable revenue** for a **pricing year**. If **Transpower** determines it is necessary to do so, **Transpower** may reduce all **capped customers' cap reductions** for a **pricing year** on a pro rata basis to ensure **Transpower** recovers **recoverable revenue** for the **pricing year** (but not more than **recoverable revenue** for the **pricing year**).

Clause 110(4): revoked, on 31 July 2023, by clause 20 of the Electricity Industry Participation Code Amendment (Transmission Pricing Methodology Amendments) 2023.

111 Difference Cap

(1) A **capped customer's difference cap** for **pricing year n** (DC_n) is calculated as follows:

$$DC_n = NEB_{19} \times (0.035 + (0.02 \times N) + \Delta CPI_n + \Delta TGE_n)$$

where

NEB₁₉ is the **capped customer's notional electricity bill** for **pricing year 2019** calculated under subclause (2)

N is—

0 if the **capped customer** is a **distributor**; or
the greater of 0 and $n-2024$ if the **capped customer** is a **direct consumer**

ΔCPI_n is the proportionate change in **CPI** for **pricing year** n calculated under subclause (3)

ΔTGE_n is the proportionate increase (if any) in the **capped customer's total gross energy** for **pricing year** n calculated under subclause (5).

- (2) A **capped customer's notional electricity** bill for **pricing year** 2019 (NEB_{19}) is calculated as follows:

$$NEB_{19} = LC_{19} + (P_{19} \times TGE_{19})$$

where

LC_{19} is—

- (a) if the **capped customer** is a **distributor**, the **capped customer's** “total line charge revenue” for **pricing year** 2019, as disclosed in the **capped customer's** Report on Billed Quantities and Line Charge Revenues (Schedule 8) under the **EDB ID determination** for its disclosure year ended 31 March 2020; or
- (b) if the **capped customer** is a **direct consumer**, the **capped customer's** total annual transmission charges for **pricing year** 2019 under the **previous transmission pricing methodology**

P_{19} is the volume weighted average of **final prices** at the **capped customer's connection locations** during **CMP G**, using **gross energy** per **trading period** for weighting

TGE_{19} is the **capped customer's total gross energy** for **pricing year** 2019, being—

- (a) if the **capped customer** is a **distributor**, the **capped customer's** “electricity entering system for supply to consumers' connection points” for **pricing year** 2019, as disclosed in the **capped customer's** Report on Network Demand (Schedule 9e) under the **EDB ID determination** for its disclosure year ended 31 March 2020; or
- (b) if the **capped customer** is a **direct consumer**, as determined by **Transpower**.

- (3) Subject to subclause (4), the proportionate change in **CPI** for **pricing year** n (ΔCPI_n) is calculated as follows:

$$\Delta CPI_n = \frac{CPI_{n-2}}{CPI_{19}} - 1$$

where

CPI_{n-2} is the average of the quarterly **CPIs** for **pricing year** $n-2$

CPI_{19} is 1041.75, being the average of the quarterly **CPIs** for **pricing year** 2019.

- (4) If there is a base adjustment to **CPI**, the calculation in subclause (3) is to include an equivalency adjustment to eliminate the impact of the base adjustment.

- (5) The proportionate increase (if any) in a capped customer's total gross energy for pricing year n (ΔTGE_n) is calculated as follows:

$$\Delta TGE_n = \frac{TGE_{n-2}}{TGE_{19}} - 1$$

where

- TGE_{n-2} is the **capped customer's total gross energy** for **pricing year** n-2, being—
- if the **capped customer** is a **distributor**, the **capped customer's** "electricity entering system for supply to consumers' connection points" for **pricing year** n-2, as disclosed in the **capped customer's** Report on Network Demand (Schedule 9e) under the **EDB ID determination** for its disclosure year ended 31 March of year n-1; or
 - if the **capped customer** is a **direct consumer**, as determined by **Transpower**.

TGE_{19} is as defined in subclause (2) for the **capped customer**.

112 Cap Recovery Charge

- (1) Only **customers** who do not receive a **cap reduction** for a **pricing year** pay a **cap recovery charge** for the **pricing year**.
- (2) A **customer's annual cap recovery charge** for a **pricing year** (ACRC) is calculated as follows:

$$ACRC = CR_{total} \times \frac{CRRC}{CRRC_{total}}$$

where

CR_{total} is the total of all **customers' cap reductions** for the **pricing year**

$CRRC$ is the **customer's cap recovery-relevant charges** for the **pricing year**

$CRRC_{total}$ is the total of all **customers' cap recovery-relevant charges** for the **pricing year**, excluding **cap-recovery relevant charges** for **customers** who receive a **cap reduction** for the **pricing year**.

- (3) A **customer's monthly cap recovery charge** for a **pricing year** (MCRC) is calculated as follows:

$$MCRC = \frac{ACRC}{12}$$

where ACRC is the **customer's annual cap recovery charge** for the **pricing year**.

- (4) Except as otherwise stated in this **transmission pricing methodology**, **cap recovery charges**—
- are calculated at the start of a **pricing year** only; and
 - are not re-calculated during a **pricing year** if there is an adjustment to other **transmission charges** during the **pricing year**.

Clause 112: replaced, on 31 July 2023, by clause 21 of the Electricity Industry Participation Code Amendment (Transmission Pricing Methodology Amendments) 2023.

Part I Prudent Discount Policy

General

113 Effect of Prudent Discount Agreements

Despite anything else in this **transmission pricing methodology**, a **prudent discount recipient's transmission charges** are subject to its **prudent discount** agreement.

114 Prudent Discount Applications

- (1) If a **customer** wishes to receive a **prudent discount**, the **customer** must submit to **Transpower** a written **application** for the **prudent discount** that meets the requirements of subclause (2).
- (2) The **application** must—
 - (a) contain all of the information described in the relevant **application requirements**; and
 - (b) contain reasonable evidence that the conditions for obtaining the **prudent discount** in this **transmission pricing methodology** are met; and
 - (c) include at least the level of detail a prudent board of directors of a company would reasonably expect when assessing an investment proposal for the **alternative project** proposed in the **application**; and
 - (d) be accompanied by an **independent verification** of the **application**.
- (3) The **customer** must provide **Transpower** with any additional information **Transpower** determines is necessary to enable it to assess the **application**.

115 Application Screening and Publication

- (1) **Transpower** must reject an **application** for a **prudent discount** without assessing the **application** further if the applicant is not a **customer**.
- (2) **Transpower** may reject a **customer's application** for a **prudent discount** without assessing the **application** further—
 - (a) under subclause 14(1); or
 - (b) if a **customer** has previously applied for a **prudent discount** on substantially the same basis as the new **application** and **Transpower**—
 - (i) rejected the previous **application**; and
 - (ii) determines there has not been a change in circumstances since its decision on the previous **application** that materially increases the likelihood of the new **application** being approved.
- (3) **Transpower** is not required to consult on any decision to reject an **application** under subclause (1), (2) or 14(1).
- (4) Unless **Transpower** rejects an **application** under subclause (1), (2) or 14(1), and subject to clause 125, **Transpower** must **publish** the **application** and any information the **customer** provides to **Transpower** under subclause 114(3).

116 Assessment

- (1) In assessing a **customer's application** for a **prudent discount**, **Transpower**—
 - (a) is not obliged to use the information the **customer** provided in or in support of the **application**, but must not assess an **alternative project** that is not the **alternative project** proposed in the **application**; and
 - (b) may use any other information relevant to the **application**.

- (2) In assessing whether the **alternative project** would provide the same or a substantially similar level of service to the **customer** as the **transmission services** it currently receives, **Transpower** must consider—
- (a) access to **electricity**, including access to security of supply; and
 - (b) **electricity** quality, reliability and security; and
 - (c) any other service measures for **transmission services** **Transpower** determines are relevant.

117 Calculation of Alternative Project Costs

- (1) The **alternative project costs** for an **alternative project** are the capital, operating, maintenance and overhead costs of the **alternative project**, as would be incurred by:
- (a) the **customer**, in the case of an **inefficient bypass prudent discount**; or
 - (b) an efficient **transmission services** provider, in the case of a **stand-alone cost prudent discount**.
- (2) For the purposes of calculating the **alternative project costs**—
- (a) the value of any increase or decrease in **electrical** losses that would result from the **alternative project** must be included as an operating cost of the **alternative project** (with a decrease being treated as a negative cost); and
 - (b) an efficient **transmission services** provider is assumed not to have any of **Transpower's** historic statutory rights in respect of **works** or activities.

118 Assessment of Commercial Viability

- (1) The **alternative project** proposed in a **customer's application** for a **prudent discount** is only commercially viable if it is reasonably likely that:

$$\frac{PVATC - PVAPC}{PVAPC} > 0.1$$

where

PVAPC is the present value of the **alternative project costs** for the **alternative project** calculated under subclause (2)

PVATC is the present value of the **customer's avoided charges** calculated under subclause (2)

- (2) In calculating the present values under subclause (1) (PV), **Transpower** must use the formula:

$$PV = \sum_n \frac{A_n}{(1+r)^n}$$

where

A_n are the **alternative project costs** or **avoided charges** (as the case may be) for year n of the relevant **prudent discount calculation period**

r is the relevant **prudent discount rate**, which must be pre-tax if the cash flows being discounted are pre-tax and post-tax if the cash flows being discounted are post-tax.

- (3) To avoid doubt—
- (a) the calculation under subclause (2) does not assume the **alternative project** is fully amortised over the **prudent discount calculation period**; and
 - (b) any residual value of the **alternative project** at the end of the **prudent discount calculation period** is ignored in the calculation under subclause (2).

Clause 118(1) and (2): amended, on 31 July 2023, by clause 22 of the Electricity Industry Participation Code Amendment (Transmission Pricing Methodology Amendments) 2023.

119 Consultation on Draft Decision

- (1) Subject to subclause 115(3), **Transpower** must consult with all **customers** on its draft decision to approve or reject a **customer's application** for a **prudent discount**.
- (2) Subject to clause 125, **Transpower's** consultation under subclause (1) must include—
- (a) the information specified in paragraphs 124(a) and 124(c) and subparagraph 124(b)(i) for the draft decision; and
 - (b) if **Transpower** proposes to approve the **application**, the terms of the proposed **prudent discount** agreement specified in subparagraphs 125(2)(b)(ii), 125(2)(b)(iii) and 125(2)(b)(iv).

120 Decision and Independent Review

- (1) If **Transpower** decides to approve a **customer's application** for a **prudent discount**, **Transpower** may—
- (a) approve different terms of the **prudent discount** than sought in the **application**, including a different amount of the **prudent discount**; and
 - (b) approve the **application** subject to reasonable conditions.
- (2) **Transpower** must notify the **customer** whether **Transpower** approves or rejects the **application**. **Transpower's** notice must include—
- (a) the information specified in paragraphs 124(a) and 124(c) and subparagraph 124(b)(i); and
 - (b) if **Transpower** approves the **application**, the terms of the proposed **prudent discount** agreement specified in subparagraphs 125(2)(b)(ii), 125(2)(b)(iii) and 125(2)(b)(iv).
- (3) The **customer** may, within 60 days of **Transpower** notifying the **customer** of **Transpower's** decision on the **application**, refer any aspect of **Transpower's** decision to an **independent expert** for review.
- (4) The **independent expert's** decision will be binding on **Transpower** and the **customer**, and will have effect as if **Transpower** had made the decision itself, except that the **customer** may not refer the decision to an **independent expert** again.
- (5) The costs of the **independent expert** must be met by the **customer** unless the **independent expert** decides an aspect of **Transpower's** decision under review was unreasonable, in which case **Transpower** may be required to meet all or some of the costs of the **independent expert**, as determined by the **independent expert**.

121 Prudent Discount Agreement

- (1) If **Transpower** approves a **customer's application** for a **prudent discount**, **Transpower** must promptly offer a **prudent discount** agreement to the **customer**.

- (2) The **prudent discount** agreement must provide for—
- (a) the **prudent discount** agreement to be of no effect unless and until all of the conditions precedent of **Transpower's** approval (if any) are satisfied; and
 - (b) the **customer** to pay **Transpower** an annuity, calculated under clause 123, in monthly instalments; and
 - (c) **Transpower** to calculate the **customer's transmission charges** in accordance with clause 132 or 137, as applicable; and
 - (d) **Transpower** to have the right to terminate the **prudent discount** agreement immediately if any condition subsequent of **Transpower's** approval is not, or ceases to be, satisfied; and
 - (e) the **customer** to have the right to terminate the **prudent discount** agreement at the start of a **pricing year** by notifying **Transpower** at least 6 months before the start of the **pricing year**.
- (3) The term of the **prudent discount** agreement must be the same as the relevant **prudent discount calculation period**, subject to—
- (a) satisfaction of all conditions precedent of **Transpower's** approval (if any); and
 - (b) earlier termination in accordance with the terms of the **prudent discount** agreement.
- To avoid doubt, the term of the **prudent discount** agreement must start on the **prudent discount's start pricing year**, subject to satisfaction of all conditions precedent of **Transpower's** approval (if any).
- (4) The annuity payable to **Transpower** by a **customer** under a **prudent discount** agreement is deemed to be a charge payable to **Transpower** under this **transmission pricing methodology** for **transmission services** provided to the **customer**.

122 Back-dated Prudent Discounts

- (1) This clause 122 back-dates the **start pricing year** for a **back-dated prudent discount** and provides for a wash-up of the **prudent discount recipient's transmission charges** as necessary to give effect to that back-dating.
- (2) The **start pricing year** for a **back-dated prudent discount** is the **first pricing year**.
- (3) If a **back-dated prudent discount** is not reflected in the **transmission charges** for the **back-dated prudent discount's start pricing year** or any later **pricing year** during the term of the relevant **prudent discount agreement** (a relevant **pricing year**), **Transpower** must carry out a wash-up of the **prudent discount recipient's transmission charges** for each relevant **pricing year** so that the **prudent discount recipient** is not over-charged **transmission charges** for the relevant **pricing years**. The wash-up—
- (a) must be carried out in the earliest practicable **pricing year**; and
 - (b) must include a time value of money adjustment using **Transpower's ID WACC** (pre-tax); and
 - (c) must not include a wash-up of **transmission charges** for any **customer** who is not the **prudent discount recipient**.
- (4) To avoid doubt, there is no wash-up under subclause (3) for a relevant **pricing year** if all conditions precedent of **Transpower's** approval of the **back-dated prudent discount** (if any) are not satisfied before or during the relevant **pricing year**.

123 Calculation of Annuity

The annuity under a **prudent discount** agreement (AN) is levelised and calculated as follows:

$$AN = \frac{PVAPC}{\sum_{n=1}^N \frac{1}{(1+r)^n}}$$

where

- N is the number of years in the relevant **prudent discount calculation period**, with each such year being year n
- PVAPC is the present value of the **alternative project costs** for the relevant **alternative project** calculated under subclause 118(2)
- r is the relevant **prudent discount rate**, which must be pre-tax if the present value of the **alternative project costs** for the **alternative project** is pre-tax and post-tax if the present value of the **alternative project costs** for the **alternative project** is post-tax.

124 Decision to be Published

Subject to clause 125, as soon as reasonably practicable after the **prudent discount confirmation date**, **Transpower** must **publish**—

- (a) its decision to approve or reject the **customer's application** for the **prudent discount**; and
- (b) if **Transpower** approves the **application**—
 - (i) any conditions of its approval; and
 - (ii) a copy of the relevant **prudent discount** agreement; and
- (c) its analysis supporting its decision, including any material departures from the assumptions and methodologies in the **prudent discount practice manual** and the reasons for those departures; and
- (d) any report prepared by an **independent expert** relating to the **prudent discount**.

125 Commercially Sensitive Information

(1) Subject to subclause (2), **Transpower** is not obliged to **publish** any information under subclause 115(4) or 119(2) or clause 124 if—

- (a) the **customer** identifies the information as commercially sensitive; and
- (b) **Transpower** determines the disclosure of the information would be likely to commercially disadvantage the **customer** or any other person, in a material manner.

(2) **Transpower** must always **publish** under subclause 119(2) and clause 124 at least—

- (a) its draft decision or decision (as the case may be) to approve or reject the **customer's application** for the **prudent discount**; and
- (b) if **Transpower** approves the application—
 - (i) reasonable details of the **alternative project** and **alternative project costs**; and
 - (ii) the annuity under the **prudent discount** agreement and details of how it was calculated; and
 - (iii) details of how the **prudent discount recipient's transmission charges** will be calculated under the **prudent discount** agreement; and
 - (iv) the term of the **prudent discount** agreement.

126 Application Fees, Application Requirements and Prudent Discount Practice Manual

(1) **Transpower** must **publish** the **application requirements** and the **application fees**, if any, for **prudent discount applications** by the start of the **first pricing year**. **Transpower** may **publish** updates to the **application requirements** and **application fees** from time to time.

- (2) **Transpower** must **publish**, and may from time to time **publish** updates to, a **prudent discount practice manual**.
- (3) The **prudent discount practice manual** must not contain any assumptions or methodologies that are inconsistent with this Code.
- (4) Subject to subclause (5), **Transpower** must consult with all **customers** on the **prudent discount practice manual** or any update to it before **publishing** the **prudent discount practice manual** or update.
- (5) **Transpower** is not required to consult on an update to the **prudent discount practice manual** if **Transpower** determines—
 - (a) the update is technical and non-controversial; or
 - (b) there is widespread support for the update among **customers**; or
 - (c) there has been adequate prior consultation on the update so that all relevant views of **customers** have been considered.
- (6) The **prudent discount practice manual** is not binding on **Transpower** or any **independent expert**.
- (7) **Transpower** must review the content of the **prudent discount practice manual** and consider whether any of the content is appropriate for incorporation in this **transmission pricing methodology** by way of a review under clause 12.85 of this Code no later than 7 years after its date of **publication** and, after that, at intervals of no more than 7 years.
- (8) The **prudent discount practice manual** may be part of the same document in which the **assumptions book** or **reassignment practice manual** is contained.

Inefficient Bypass Prudent Discount

127 Purpose of Inefficient Bypass Prudent Discount

The purpose of an **inefficient bypass prudent discount** is to help ensure this **transmission pricing methodology** does not provide incentives for a **customer** to invest in an **alternative project** that would allow a **customer** to reduce its own **transmission charges**, by bypassing existing **grid assets**, while increasing total economic costs.

128 Multiple Benefitting Customers

If there is more than 1 **benefitting customer** for an **application** for an **inefficient bypass prudent discount**—

- (a) all references to the applicant **customer** or **prudent discount recipient** in clauses 113 to 132 and 138 are deemed to include every **benefitting customer**; and
- (b) without limiting paragraph (a)—
 - (i) the commercial viability test in clause 118 must be applied using the total **avoided charges** of all **benefitting customers**; and
 - (ii) the inefficiency test in subclause 130(2) must be applied using **Transpower's** costs of providing **transmission services** to all **benefitting customers**; and
- (c) the highest **prudent discount rate** across the **benefitting customers** applies to the **application**.

Clause 128(b)(i): amended, on 31 July 2023, by clause 23 of the Electricity Industry Participation Code Amendment (Transmission Pricing Methodology Amendments) 2023.

129 Assessment of Equivalence, Feasibility and Commercial Viability

Transpower must assess whether the **alternative project** for an **inefficient bypass prudent discount**—

- (a) would provide the **customer** with the same or a substantially similar level of service as the **transmission services** the **customer** currently receives from the **grid assets** the **alternative project** would bypass; and
- (b) is technically feasible using present day technology and construction methods, including that it is feasible for the **customer** to obtain the necessary resource consents and property rights for the **alternative project**; and
- (c) is operationally feasible, including that the **alternative project** is compliant with applicable **asset owner performance obligations, technical codes** and any other requirements in Part 8 of this Code; and
- (d) is otherwise consistent with **GEIP**; and
- (e) is commercially viable under subclause 118.

Clause 129(e): amended, on 31 July 2023, by clause 24 of the Electricity Industry Participation Code Amendment (Transmission Pricing Methodology Amendments) 2023.

130 Assessment whether the Alternative Project is Inefficient

- (1) If **Transpower** determines the **alternative project** for an **inefficient bypass prudent discount** satisfies all of the criteria in clause 129, **Transpower** must assess whether the **alternative project** is inefficient under subclause (2)
- (2) The **alternative project** is only inefficient if it is reasonably likely that—

$$PVAPC > (PVT C_{no\ ap} - PVT C_{ap})$$

where

PVAPC is the present value of the capital, operating, maintenance and overhead costs of the **alternative project**, including, but not limited to, the **alternative project costs**

PVTC_{no ap} is the present value of **Transpower's** capital, operating, maintenance and overhead costs of providing **transmission services** to the **customer** at the required service levels, including the cost of future **transmission investments**, without the **alternative project** calculated under subclause (3)

PVTC_{ap} is the present value of **Transpower's** capital, operating, maintenance and overhead costs of providing **transmission services** to the **customer** at the required service levels, including the cost of future **transmission investments**, with the **alternative project** calculated under subclause (3).

- (3) In calculating the present values under subclause (2) (PV), **Transpower** must use the formula:

$$PV = \sum_n \frac{C_n}{(1+r)^n}$$

where

C_n is the relevant costs for year n of the relevant **prudent discount calculation period**

r is the relevant **prudent discount rate**, which must be pre-tax if the cash flows being discounted are pre-tax and post-tax if the cash flows being discounted are post-tax.

131 Approval or Rejection of Inefficient Bypass Prudent Discount Application

- (1) **Transpower** must approve a **customer's application** for an **inefficient bypass prudent discount** if **Transpower** determines—
 - (a) the **alternative project** for the **application** satisfies all of the criteria in clause 129; and
 - (b) the **alternative project** is inefficient under subclause 130(2).
- (2) Otherwise, **Transpower** must reject the **application**.

132 Impact on Transmission Charges

A **prudent discount** agreement for an **inefficient bypass prudent discount** must provide for **Transpower** to calculate the **prudent discount recipient's transmission charges** during the term of the **prudent discount** agreement as if the relevant **alternative project** had been implemented, assuming none of its **alternative project costs** would be recovered through **transmission charges**.

Stand-alone Cost Prudent Discount

133 Purpose of Stand-alone Cost Prudent Discount

The purpose of a **stand-alone cost prudent discount** is to help ensure this **transmission pricing methodology** does not result in a **customer** paying **transmission charges** that exceed the efficient stand-alone cost of the **transmission services** the **customer** currently receives. A **stand-alone cost prudent discount** achieves this by replacing the **prudent discount recipient's connection charges, benefit-based charges and residual charge** with an annuity under a **prudent discount agreement** equal to the **alternative project costs** of an **efficient stand-alone investment**.

134 Assessment of Equivalence, Feasibility and Commercial Viability

- (1) **Transpower** must assess whether the **alternative project** for a **stand-alone cost prudent discount**—
 - (a) is an **efficient stand-alone investment** that would provide the **customer** with the same or a substantially similar level of service as the **transmission services** the **customer** currently receives; and
 - (b) subject to subclause (2), is technically feasible using present day technology and construction methods; and
 - (c) is operationally feasible, including that the **alternative project** is compliant with applicable **asset owner performance obligations, technical codes** and any other requirements in Part 8 of this Code; and
 - (d) is otherwise consistent with **GEIP**; and
 - (e) is commercially viable under clause 118.
- (2) The **alternative project** is technically feasible even if it is not feasible to obtain any or all of the necessary resource consents and property rights for the **alternative project**, provided that the **alternative project** is technically feasible in all other respects. In calculating the **alternative project costs**, **Transpower** must use estimates of the likely cost of obtaining any resource consents and property rights that are not feasible to obtain based on the cost of obtaining broadly equivalent resource consents and property rights for feasible activities in feasible locations.
- (3) In calculating the **alternative project costs**, **Transpower** must value any optimised **grid** that forms part of the **alternative project** in a way that accounts for **depreciation** according to the age of the part of the existing **grid** that is optimised.

- (4) To avoid doubt, **Transpower** must carry out the assessment under subclause (1) on a single **customer** basis.

135 Assessment of Efficient Stand-alone Investment

- (1) An **efficient stand-alone investment** is an investment in the **grid**, 1 or more **transmission alternatives**, or a combination of both that an efficient **transmission services** provider would make to supply **transmission services** solely to the **customer** who has applied for a **stand-alone cost prudent discount**, assessed by—
- (a) using the existing **grid**, existing **transmission alternatives** and the **customer's** existing **grid points of connection** as a starting point; and
 - (b) applying optimisation tests to the **grid** and **transmission alternatives** to identify, in the single-**customer** hypothetical, stranded **grid assets** and **transmission alternatives**, excess **capacity in grid assets** and **transmission alternatives**, and other **grid** and **transmission alternative** over-engineering.
- (2) The **efficient stand-alone investment** does not need to be in the same location or follow the same route as the existing **grid** or existing **transmission alternatives**.

136 Approval or Rejection of Stand-alone Cost Prudent Discount Application

- (1) **Transpower** must approve a **customer's** **application** for a **stand-alone cost prudent discount** if **Transpower** determines the **alternative project** for the **application** satisfies all of the criteria in subclause 134(1).
- (2) Otherwise, **Transpower** must reject the **application**.

137 Impact on Transmission Charges

A **prudent discount** agreement for a **stand-alone cost prudent discount**—

- (a) must provide for the **prudent discount recipient's** **connection charges**, **benefit-based charges** and **residual charge** to be 0 during the term of the **prudent discount** agreement; and
- (b) must not provide for a change to any other **transmission charge**.

Prudent Discount Recovery

138 Prudent Discount Recovery Charges

- (1) The amount of a **prudent discount** is recovered by **Transpower** through—
- (a) **BBi prudent discount recovery charges**, which—
 - (i) recover the part of the amount of the **prudent discount** deemed to relate to **discounted BBIs**; and
 - (ii) are paid by the **beneficiaries** of the **discounted BBIs** other than the **prudent discount recipient**; and
 - (b) **residual prudent discount recovery charges**, which
 - (i) recover the part of the amount of the **prudent discount** not recovered by **BBi prudent discount recovery charges** (if any); and
 - (ii) are paid by the **load customers** other than the **prudent discount recipient**.
- (2) Subject to subclause (4), **customer c's** **BBi prudent discount recovery charge** for **discounted BBi b** and a **pricing year** ($BPDS_{cb}$), where **customer c** is a **beneficiary** of **discounted BBi b** and not the **prudent discount recipient**, is calculated as follows:

$$BPDS_{cb} = PD \times \frac{BBC_{recipient\ b}}{\sum_k BBC_{recipient\ k} + RC_{recipient}} \times \frac{BBC_{cb}}{\sum_j BBC_{jb}}$$

where

- PD** is the amount of the relevant **prudent discount** for the **pricing year**
- BBC_{recipient b}** is the **prudent discount recipient's annual benefit-based charge** for **discounted BBI b** and the **pricing year** without the **prudent discount**
- BBC_{recipient k}** is the **prudent discount recipient's annual benefit-based charge** for **discounted BBI k** for the **pricing year** without the **prudent discount**, where **discounted BBI k** is a **discounted BBI** for the **prudent discount** (including **discounted BBI b**)
- RC_{recipient}** is—
- (a) if the **prudent discount** includes any discount to the **prudent discount recipient's residual charge** or **connection charges**, the **prudent discount recipient's annual residual charge** for the **pricing year** without the **prudent discount**; or
 - (b) otherwise, 0
- BBC_{cb}** is **customer c's annual benefit-based charge** for **discounted BBI b** and the **pricing year**
- BBC_{jb}** is **customer j's annual benefit-based charge** for **discounted BBI b** and the **pricing year**, where **customer j** is a **beneficiary** of **discounted BBI b** and not the **prudent discount recipient** (including **customer c**).

- (3) Subject to subclause (4), **customer c's residual prudent discount recovery charge** for a **prudent discount** and **pricing year** (**RPDS_c**), where **customer c** is a **load customer** and not the **prudent discount recipient**, is calculated as follows:

$$RPDS_c = (PD - BPDS) \times \frac{RC_c}{\sum_j RC_j}$$

where

- PD** is the amount of the **prudent discount** for the **pricing year**
- BPDS** is the part of the amount of the **prudent discount** to be recovered through **BBI prudent discount recovery charges** for the **pricing year**
- RC_c** is **customer c's annual residual charge** for the **pricing year**
- RC_j** is **customer j's annual residual charge** for the **pricing year**, where **customer j** is not the **prudent discount recipient** (including **customer c**).

- (4) The minimum value of a **BBI prudent discount recovery charge** or **residual prudent discount recovery charge** is 0.

(5) A **customer's annual prudent discount recovery charge** for a **pricing year** (APDRC) is the sum of the **customer's BBI prudent discount recovery charges** and **residual prudent discount recovery charges** for the **pricing year**.

(6) A **customer's monthly prudent discount recovery charge** for a **pricing year** (MPDRC) is calculated as follows:

$$MPDRC = \frac{APDRC}{12}$$

where APDRC is the **customer's annual prudent discount recovery charge** for the **pricing year**.

(7) Except as otherwise stated in this **transmission pricing methodology**, **prudent discount recovery charges**—

- (a) are calculated at the start of a **pricing year** only; and
- (b) are not re-calculated during a **pricing year** if there is an adjustment to other **transmission charges** during the **pricing year**.

**Electricity Industry Participation Code 2010
Schedule 12.4, Appendix A**

Appendix A – BBIs and Starting BBI Customer Allocations

Customer	Bunnythorpe Haywards	HVDC	LSI Reliability	LSI Renewables	NIGU	UNIDRS	Wairakei Ring
Alpine Energy Ltd	3.09%	0.86%	1.50%	2.99%	0.30%	0.30%	0.24%
Aurora Energy Ltd	5.67%	1.57%	0.91%	4.50%	0.30%	0.30%	0.27%
Beach Energy Resources NZ (Holdings) Ltd	0.03%	0.07%	0.10%	0.08%	0.03%	0.03%	0.04%
Buller Electricity Ltd	0.26%	0.08%	0.08%	0.19%	0.01%	0.01%	0.01%
Centralines Ltd	0.07%	0.21%	0.24%	0.17%	0.05%	0.05%	0.01%
Contact Energy Ltd	2.09%	12.58%	24.11%	0.09%	5.92%	5.92%	21.38%
Counties Energy Ltd	0.31%	1.06%	1.09%	0.85%	2.62%	2.62%	1.42%
Daiken Southland Ltd	0.27%	0.09%	1.39%	0.28%	0.02%	0.02%	0.02%
EA Networks Ltd	1.69%	0.51%	0.76%	1.72%	0.26%	0.26%	0.15%
Eastland Network Ltd	0.17%	0.35%	0.57%	0.41%	0.05%	0.05%	0.00%
Electra Ltd	2.60%	0.55%	0.65%	0.45%	0.11%	0.11%	0.09%
Genesis Energy Ltd	1.21%	3.24%	0.00%	0.03%	3.65%	3.65%	7.69%
GTL Energy (New Zealand) Pty Ltd	0.00%	0.00%	0.01%	0.00%	0.00%	0.00%	0.00%

**Electricity Industry Participation Code 2010
Schedule 12.4, Appendix A**

Customer	Bunnythorpe Haywards	HVDC	LSI Reliability	LSI Renewables	NIGU	UNIDRS	Wairakei Ring
Horizon Energy Distribution Ltd	0.23%	0.24%	0.37%	0.43%	0.04%	0.04%	0.00%
KiwiRail Holdings Ltd	0.03%	0.07%	0.11%	0.08%	0.20%	0.20%	0.12%
Mainpower New Zealand Ltd	3.19%	0.88%	1.29%	2.96%	0.24%	0.24%	0.20%
Manawa Energy Ltd	0.00%	0.65%	0.00%	0.01%	0.16%	0.16%	1.15%
Marlborough Lines Ltd	2.02%	0.45%	0.87%	1.88%	0.15%	0.15%	0.13%
Mercury NZ Ltd	0.70%	0.06%	0.09%	0.07%	6.80%	6.80%	10.73%
Mercury SPV Ltd	0.38%	0.02%	0.00%	0.00%	0.25%	0.25%	0.00%
Meridian Energy Ltd	0.23%	33.80%	1.11%	0.05%	7.32%	7.32%	0.00%
Methanex New Zealand Ltd	0.03%	0.06%	0.09%	0.07%	0.03%	0.03%	0.04%
Nelson Electricity Ltd	0.28%	0.06%	0.12%	0.23%	0.02%	0.02%	0.02%
Network Tasman Ltd	3.04%	0.71%	1.35%	2.58%	0.20%	0.20%	0.17%
Network Waitaki Ltd	1.12%	0.36%	0.53%	2.17%	0.13%	0.13%	0.08%
New Zealand Aluminium Smelters Ltd	21.91%	7.27%	2.14%	23.72%	1.60%	1.60%	1.62%
New Zealand Steel Ltd	0.30%	0.51%	0.97%	0.85%	2.46%	2.46%	1.34%

**Electricity Industry Participation Code 2010
Schedule 12.4, Appendix A**

Customer	Bunnythorpe Haywards	HVDC	LSI Reliability	LSI Renewables	NIGU	UNIDRS	Wairakei Ring
Nga Awa Purua Joint Venture	0.00%	0.00%	0.00%	0.00%	0.97%	0.97%	8.06%
Ngatamariki Geothermal Ltd	0.01%	0.00%	0.00%	0.00%	0.59%	0.59%	4.89%
Norske Skog Tasman Ltd	0.00%	0.00%	0.00%	0.00%	0.18%	0.18%	2.48%
Northpower Ltd	0.66%	1.13%	2.17%	1.79%	5.96%	5.96%	2.92%
Nova Energy Ltd	0.04%	0.00%	0.00%	0.00%	0.03%	0.03%	0.00%
OMV NZ Production Ltd	0.04%	0.10%	0.14%	0.12%	0.04%	0.04%	0.06%
Orion New Zealand Ltd	18.12%	4.90%	7.20%	14.77%	1.14%	1.14%	1.00%
Pan Pac Forest Product Ltd	0.34%	0.47%	0.77%	0.70%	0.10%	0.10%	0.00%
Powerco Ltd	4.00%	6.27%	8.60%	6.73%	1.90%	1.90%	3.61%
Powernet Ltd	5.35%	1.38%	10.60%	6.36%	0.38%	0.38%	0.35%
Scanpower Ltd	0.05%	0.15%	0.17%	0.12%	0.03%	0.03%	0.03%
Southern Generation GP Ltd	0.00%	0.00%	0.00%	0.00%	0.00%	0.00%	0.00%
Southpark Utilities Ltd	0.00%	0.00%	0.00%	0.00%	0.00%	0.00%	0.00%
Tararua Wind Power Ltd	0.26%	0.01%	0.00%	0.00%	0.16%	0.16%	0.00%

**Electricity Industry Participation Code 2010
Schedule 12.4, Appendix A**

Customer	Bunnythorpe Haywards	HVDC	LSI Reliability	LSI Renewables	NIGU	UNIDRS	Wairakei Ring
The Lines Company Ltd	0.16%	0.36%	0.47%	0.37%	0.18%	0.18%	0.49%
Todd Generation Taranaki Ltd	0.49%	0.18%	0.00%	0.03%	0.52%	0.52%	0.00%
Top Energy Ltd	0.00%	0.24%	0.00%	0.00%	1.08%	1.08%	0.52%
Unison Networks Ltd	0.63%	1.34%	2.20%	1.61%	0.16%	0.16%	0.00%
Vector Ltd	5.48%	10.79%	19.06%	14.45%	51.10%	51.10%	24.57%
Waipa Networks Ltd	0.25%	0.59%	0.82%	0.64%	0.33%	0.33%	1.02%
Waverley Wind Farm Ltd	0.23%	0.01%	0.00%	0.00%	0.15%	0.15%	0.00%
WEL Networks Ltd	0.51%	1.13%	1.82%	1.41%	1.13%	1.13%	2.38%
Wellington Electricity Lines Ltd	11.76%	4.25%	4.93%	3.23%	0.83%	0.83%	0.66%
Westpower Ltd	0.40%	0.09%	0.18%	0.46%	0.04%	0.04%	0.03%
Whareroa Co-generation Ltd	0.10%	0.03%	0.00%	0.00%	0.02%	0.02%	0.00%
Winstone Pulp International Ltd	0.16%	0.29%	0.43%	0.36%	0.07%	0.07%	0.00%

Schedule 12.5
Availability and reliability index measures

cls 12.119 and 120

Asset type	Asset category		Planned unavailability	Unplanned unavailability	Number of planned interruptions	Planned unserved energy MWh	Number of unplanned interruptions	Unplanned unserved energy MWh
Interconnection transformer branches	220/110 kV interconnecting transformers and associated equipment		1.56%	0.06%	0.03	0.10	0.02	0.72
	220/066 kV interconnecting transformers and associated equipment		0.66%	0.02%	0.00	0.00	0.00	0.00
	110/066 kV interconnecting transformers and associated equipment		2.25%	0.02%	0.00	0.00	0.00	0.00
Interconnection circuit branches	220 kV interconnection circuit branches and associated line end equipment		0.88%	0.05%	0.00	0.00	0.13	9.87
	110 kV interconnection circuit branches and associated line end equipment		1.67%	0.07%	0.08	0.50	0.28	10.45
	66 kV interconnection circuit branches and associated line end equipment		1.25%	0.08%	0.14	0.46	1.31	1.88
Shunt assets	Capacitor banks and associated equipment	High (220kV-66kV)	0.81%	1.33%	0.00	0.00	0.02	0.03
		Low (33kV-11kV)	0.81%	1.33%	0.00	0.00	0.02	0.03

**Electricity Industry Participation Code 2010
Schedule 12.5**

Asset type	Asset category	Planned unavailability	Unplanned unavailability	Number of planned interruptions	Planned unserved energy MWh	Number of unplanned interruptions	Unplanned unserved energy MWh
	Reactors and associated equipment	1.33%	0.31%	0.00	0.00	0.00	0.00
	Synchronous condensers and associated equipment	2.00%	1.00%	0.00	0.00	0.00	0.00
	Static var compensators and associated equipment	0.82%	0.04%	0.00	0.00	0.00	0.00
	Filter banks and associated equipment	1.03%	1.71%	0.00	0.00	0.00	0.00
HVDC Link Pole 2	One category including associated equipment	1.27%	0.51%	0.00	0.00	0.20	0.85

Compare: Electricity Governance Rules 2003 schedule F6A part F

**Default Transmission Agreement
Template**

Version: August 2023

**Transpower New Zealand Limited
and**

**Designated Transmission Customer:
[insert full legal name]**

TABLE OF CONTENTS

PART A: FOUNDATION	4
1. CUSTOMER'S DETAILS	4
2. TRANSPOWER'S DETAILS	4
3. BACKGROUND	4
4. COMMENCEMENT, OTHER AGREEMENTS AND REVIEWS	5
PART A1: GLOSSARY AND INTERPRETATION	6
5. GLOSSARY	6
6. DEFINITIONS IN ELECTRICITY INDUSTRY PARTICIPATION CODE 2010	9
7. INTERPRETATION	9
PART A2: GENERAL TERMS	11
8. CREDIT SUPPORT	11
9. CALCULATION OF CHARGES	11
10. INVOICING	12
11. PAYMENT	15
12. PARTIES TO PROVIDE INFORMATION	17
13. FORCE MAJEURE	17
14. DANGER TO PERSONS AND PUBLIC SAFETY	18
15. CONSEQUENCES OF DEFAULT	19
16. CONSEQUENCES OF DE-ENERGISATION	23
17. TERMINATION BY CUSTOMER ON NOTICE	24
18. TERMINATION FOR INSOLVENCY OR ILLEGALITY	24
19. GENERAL PROVISIONS CONCERNING TERMINATION	25
20. LIABILITY	27
21. DISPUTE RESOLUTION	30
22. CONFIDENTIALITY	37
23. ASSIGNMENT	39
24. GENERAL LEGAL TERMS	40
25. NOTICES	41
PART B: POINT CONNECTION	43
26. SCOPE OF POINT CONNECTION	43
27. DEFINITIONS	43
28. CONNECTION	43
29. CONNECTION CODE	44
30. INFORMATION	44
31. ACCESS	45
32. METERING INSTALLATIONS	45
33. TECHNICAL COMPLIANCE OBLIGATION	46
PART C: GRID CONNECTION	47
34. SCOPE OF GRID CONNECTION	47
35. DEFINITIONS	47
36. SERVICE STANDARDS	48
37. REPORTING	49

38. COMPLIANCE WITH LAWS, RULES AND STANDARDS	55
39. POINTS OF SERVICE SCHEDULE	55
40. CHANGING AND REMOVING CONNECTION ASSETS	58
41. GRID CHARGES	61
42. TECHNICAL COMPLIANCE OBLIGATIONS	64
PART D: SETTLEMENT RESIDUE PAYMENTS	65
43. ADMINISTRATION FEE	65
44. RECOVERY OF NEGATIVE SETTLEMENT RESIDUE	65
SCHEDULE 1 POINTS OF CONNECTION	66
SCHEDULE 2 POINTS OF SERVICE	67
SCHEDULE 3 GRID CHARGES	68
SCHEDULE 4 CONNECTION ASSETS	69
SCHEDULE 5 SERVICE MEASURES	70
SCHEDULE 6 ACCESS AND OCCUPATION SCHEDULE	76
SCHEDULE 7 CREDIT SUPPORT	85
APPENDIX 1 CREDIT POLICY	90
APPENDIX 2 GUARANTEE	93
APPENDIX 3 LETTER OF CREDIT	96
APPENDIX 4 DEED OF GUARANTEE AND INDEMNITY	100
APPENDIX 5 SURETY BOND	107
SCHEDULE 8 CONNECTION CODE	109

PART A: FOUNDATION

1. CUSTOMER'S DETAILS

1.1 Full Name of Customer:

[To insert.]

1.2 Customer's Address:

[To insert physical and postal address, and email address to which notices under this Agreement are to be delivered or sent in accordance with Subpart 2 of Part 12 of the Code.]

1.3 Customer's Contact Person:

[To insert name of individual or office holder to whom notice should be addressed in accordance with Subpart 2 of Part 12 of the Code.]

2. TRANSPOWER'S DETAILS

2.1 Transpower's Address:

[To insert physical and postal address, and email address to which notices under this Agreement are to be delivered or sent in accordance with Subpart 2 of Part 12 of the Code.]

2.2 Transpower's Contact Person:

[To insert name of individual or office holder to whom notice should be addressed in accordance with Subpart 2 of Part 12 of the Code.]

3. BACKGROUND

3.1 Transpower:

Transpower owns and operates the **grid** as **grid owner**.

3.2 Customer:

The Customer is one of the following:

- (a) a **distributor** that is directly connected to the **grid**;
- (b) a **generator** that is directly connected to the **grid**; or
- (c) a **direct consumer**.

3.3 Agreement:

This Agreement sets out the terms on which Transpower will:

- (a) permit the Customer's Assets to be connected to the **grid**; and
- (b) make the **grid** available for the conveyance of **electricity**.

4. COMMENCEMENT, OTHER AGREEMENTS AND REVIEWS

4.1 Commencement:

This Agreement commences on [the date it is signed by both parties] *or* [the date the **default transmission agreement** applies as a binding contract between Transpower and the Customer under clauses 12.10 and 12.13 of the Code] (the "Commencement Date").

4.2 Other Agreements:

- (a) Subject to clause 4.2(b), from the Commencement Date this Agreement will:
 - (1) terminate any other agreement between the parties to the extent such agreement covers the same subject matter as this Agreement; and
 - (2) prevail over any other agreement between the parties to the extent such agreement is inconsistent with this Agreement.
- (b) Notwithstanding clause 4.2(a), this Agreement will not affect:
 - (1) any investment agreement (as defined in the **transmission pricing methodology**) between the parties; or
 - (2) any contract or arrangement to which clause 17.29(1) of the Code applies to the extent that the effect of such a contract or arrangement may cause the System Operator to operate the **grid** voltage within a lesser range than that specified in the **AOPOs**.
- (c) For the avoidance of doubt:
 - (1) clause 4.2(a) does not limit clauses 12.10, 12.11, or 12.49 to 12.51 of the Code; and
 - (2) clause 31 and Schedule 6 (Access and Occupation) only apply if the criteria in clause 31.1 are met.
- (d) Except as provided in clause 4.2(a), this Agreement will not affect any other written agreement between the parties in force on the Commencement Date.
- (e) The termination of any agreement under clause 4.2(a)(1) is to be without prejudice to any liabilities or obligations outstanding under that agreement as at the Commencement Date.

PART A1: GLOSSARY AND INTERPRETATION

5. GLOSSARY

In this Agreement, unless the context otherwise requires, the following definitions apply:

Acceptable Credit Rating

has the meaning specified in clause 1 of Schedule 7;

Agreement

means this agreement, comprising all Parts and Schedules set out in the contents page to this Agreement and all documents which are listed in Part A: Foundation as being incorporated into this Agreement, as added to, amended or replaced from time to time in accordance with this Agreement;

Associates

means in relation to either Transpower or the Customer, as the case requires, its directors, officers, employees, authorised agents, contractors, sub-contractors and professional advisors;

Authority

means the Electricity Authority;

Business Day

means any day of the week other than a Saturday, Sunday, a statutory holiday as observed in Wellington, or a statutory holiday as observed in the place at which notices may be delivered to the Customer;

Charges

means any and all of the Grid Charges, the Licence Charges and any other charges payable by the Customer under any Part or Schedule;

Code

means the Electricity Industry Participation Code 2010;

Commencement Date

has the meaning specified in clause 4.1;

Connected Party

means any person who has **assets** directly connected to the **grid**;

Connection Code

means the code attached as Schedule 8 (Connection Code);

Customer

means the party or parties described in clause 1 and where more than one party means each of them jointly and severally;

Customer's Assets

means the lines, equipment and plant owned or managed by the Customer and directly related to any Point(s) of Connection, which are used for the consumption, conveyance or generation of **electricity**;

Customer Point of Service

means each of the **points of service** specified in Schedule 2 (Points of Service);

de-energisation

means, in relation to a Point of Connection:

- (a) an interruption of conveyance of **electricity**; or
- (b) the disconnection by the movement of any isolater, breaker or switch or the removal of any fuse or link by which no **electricity** can flow,

at the Point of Connection and **de-energise** is to be interpreted accordingly;

Default Rate

means, in any month, the **bank bill bid rate** appearing on the first Business Day of the month plus five percent per annum, calculated daily and capitalised monthly;

Dispute Notice

has the meaning specified in clause 21.3(a);

Dispute Meeting

has the meaning specified in clause 21.3(b);

Due Date

has the meaning specified in clause 11.2;

Estimated Quantity

means a quantity of **electricity** that is estimated under clause 9.1(a);

Force Majeure or an event or circumstance of Force Majeure

means an event or circumstance described in clause 13.1(a), (b) or (c);

Good Electricity Industry Practice

means:

- (a) in the case of Transpower when performing the functions of **grid owner**, the exercise of that degree of skill, diligence, prudence, foresight and economic management, as determined by reference to good international practice, which would reasonably be expected from a skilled and experienced **asset owner** engaged in the management (including maintenance) of a transmission network under conditions comparable to those applicable to the **grid** consistent with applicable Law, safety and environmental protection. The determination of comparable conditions is to take

into account factors such as the relative size, duty, age and technological status of the relevant transmission network and the applicable Law; and

- (b) in the case of the Customer, the exercise of that degree of skill, diligence, prudence, foresight and economic management which would reasonably be expected from a skilled and experienced **asset owner** engaged in the conveyance, generation or consumption of **electricity** (as the case may be) under conditions comparable to those applicable to the Customer's Assets consistent with applicable Law, safety and environmental protection. The determination of comparable conditions is to take into account factors such as the relative size, duty, age and technological status of the relevant **assets** and the applicable Law;

Grid Charges

means the charges set out in Schedule 3 (Grid Charges), as varied from time to time in accordance with this Agreement or the **transmission pricing methodology**;

GST

means goods and services tax payable under the GST Act (or any similar tax levied in substitution) and **GST Act** means the Goods and Services Tax Act 1985;

GST Amount

has the meaning specified in clause 11.5;

Interest Rate

means, in any month, the **bank bill bid rate** appearing on the first Business Day of the month calculated daily and capitalised monthly;

Law

means a statute, regulation, by-law or requirement of a local or territorial authority with relevant jurisdiction;

Licence Charges

means the charges payable by the Customer under Schedule 6 (Access and Occupation);

Loss

has the meaning specified in clause 20.1;

Part

means any part of this Agreement as added, amended or replaced from time to time in accordance with this Agreement or the Electricity Industry Participation Code 2010;

Point of Connection

means a connection terminal on equipment forming part of the **grid assets** at which the Customer's Assets are physically connected to the **grid** and being any of the points of connection specified in Schedule 1 (Points of Connection);

Related Company

has the meaning given in the Companies Act 1993, and includes any entity that would be related to a party if both the party and the entity were companies registered under that Act;

Schedule

means any schedule to this Agreement as added, amended or replaced from time to time in accordance with this Agreement;

Technical Compliance Obligation

means an obligation specified in clauses 33.1 or 42.1;

Transpower's Counterparty Exposure

means an amount equivalent to a total of two months' Charges based on:

- (a) where the Customer has been a customer of Transpower for 12 months or more, the average monthly Charges of the Customer over the previous 12 month period provided that Transpower may (acting reasonably) adjust that total by having regard to what Charges Transpower reasonably anticipates will be payable by the Customer in the next 12 months; or
- (b) where the Customer has been a customer of Transpower for less than 12 months, the expected average monthly Charges of the Customer over the next 12 months based on:
 - (1) an estimate by Transpower (acting reasonably) having regard to its historical records of the consumption of other relevant Transpower customers and what Transpower reasonably anticipates will be payable by the Customer in the next 12 months; or
 - (2) where there are no other relevant Transpower customers with which to compare, an amount that Transpower reasonably anticipates will be payable by the Customer in the next 12 months.

6. DEFINITIONS IN ELECTRICITY INDUSTRY PARTICIPATION CODE 2010

6.1 Code:

Any terms used in this Agreement which are defined in the Code, but which are not defined in this Agreement, have the same meaning as in the Code.

6.2 Bold terms

For ease of reference only, terms defined in the Code that are not defined in the Agreement are in bold.

7. INTERPRETATION

In this Agreement unless the context otherwise requires:

7.1 **Inconsistency:**

if any provision in Part B: Point of Connection, Part C: Grid Connection, Part D: Settlement Residue Payments or a Schedule is inconsistent or conflicts with any clause in Part A: Foundation, Part A1: Glossary and Interpretation or Part A2: General Terms, the provision in Part B, Part C or the Schedule (as the case may be) will prevail;

7.2 **Including:**

"including" and similar words do not imply any limitation;

7.3 **Headings:**

headings are for ease of reference only and are to be ignored in the interpretation of this Agreement;

7.4 **Gender and Plural:**

words importing one gender include the other gender and words importing the singular number include the plural and vice versa;

7.5 **Parties:**

references to a party or a person include any form of entity and their respective successors, permitted assignees or transferees;

7.6 **Dollars:**

all amounts are in New Zealand dollars and are expressed exclusive of GST;

7.7 **Negative Obligations:**

any obligation not to do anything is deemed to include an obligation not to suffer, permit or cause that thing to be done;

7.8 **Statutes, Regulations:**

references to a statute include references to regulations, codes, orders or notices made under such statute, and all amendments to, or substitutions for, such statute;

7.9 **Documents:**

references to a document or agreement (including the Code) include references to all amendments to, substitutions for or novations of that document or agreement;

7.10 **Month and Year:**

references to a month or year are references to a calendar month or a calendar year; and

7.11 Rights:

a right conferred by this Agreement to do any act or thing is capable of being exercised from time to time.

PART A2: GENERAL TERMS

8. CREDIT SUPPORT

8.1 Credit Support:

The Customer will provide credit support if required in accordance with Schedule 7 (Credit Support).

9. CALCULATION OF CHARGES

9.1 Quantities of Electricity:

Subject to clause 9.4, where any Charges are to be calculated by direct reference to a **reconciled quantity**, pending receipt of any relevant **reconciled quantity**, Transpower may estimate the quantity of **electricity** which it reasonably considers to have been conveyed and that estimate is to be used for the purposes of the relevant calculation of Charges. For the avoidance of doubt, if the Customer disputes the estimate the Customer may dispute the relevant invoice under clause 10.7.

9.2 Information:

(a) Information from Customer:

If Transpower reasonably requires information as to any matter from the Customer for the purpose of calculating any Charge, the Customer is to provide the information to Transpower promptly on request. In addition, the Customer must proactively and promptly provide Transpower with any information about the actual or planned connection or disconnection of **embedded plant** to or from the Customer's **assets** if the connection or disconnection of that **plant** may have an impact on any Charge.

(b) Information from Reconciliation Manager:

The Customer authorises the **reconciliation manager**, without direction or authority from the Customer, to provide to Transpower any information held by the **reconciliation manager** which Transpower reasonably requires for the purposes of calculating any Charge. This clause is intended to confer a benefit on, and be enforceable by, the **reconciliation manager** under Subpart 1 of Part 2 of the Contract and Commercial Law Act 2017.

(c) Authorisation to Use Information:

The Customer authorises Transpower to use any information received under this clause 9.2 for the purposes of calculating the Charges and calculating **transmission charges** for any other **designated transmission customer**.

9.3 Estimates:

Subject to clause 9.4, if the information referred to in clause 9.2 is not provided in a sufficiently timely manner for Transpower to calculate the relevant Charge and invoice the Customer in accordance with clause 10, Transpower may calculate the relevant Charge based on Transpower's reasonable estimate of the information. For the avoidance of doubt, if the Customer disputes the estimate the Customer may dispute the relevant invoice under clause 10.7.

9.4 Code Obligations to Use Particular Inputs:

Clauses 9.1 and 9.3 are subject to any obligations of Transpower under the **Code** to use inputs other than **reconciled quantities** to calculate the Charges.

10. INVOICING

10.1 Invoicing:

Each month, Transpower will invoice the Customer for:

(a) **Charges:**

all Charges for the month; and

(b) **Other Amounts:**

any other Charges due and payable by the Customer under this Agreement (including any adjustments of prior invoices).

If it is not reasonably practicable for Transpower to invoice the Customer for all Charges for the month, Transpower may defer invoicing part or all of such Charges. Transpower will use reasonable endeavours to deliver an invoice to the Customer by the 20th day of the month.

10.2 Invoices:

Transpower may provide:

(a) **Separate or Combined Invoice:**

separate invoices for Charges payable under any Part or a combined invoice for Charges payable under some or all Parts; and

(b) **Multiple invoices:**

more than one invoice for Charges payable under any Part.

10.3 Contents of Invoice:

Each invoice or accompanying credit note is to:

(a) **GST Invoice:**

specify any GST Amount payable by the Customer under clause 11.5 and comply with the GST Act;

(b) **Cash Bond Interest:**

if the Customer has provided a cash bond under Schedule 7, specify the interest payable by Transpower in accordance with clause 6(d) of Schedule 7;

(c) **Component Charges Identified Separately:**

if a combined invoice for amounts payable under different Parts, separately identify the amounts payable by reference to each Part; and

(d) **Charges for Connection Locations Identified Separately:**

for each **connection location**, separately identify Charges which relate only to that **connection location**. To avoid doubt, this does not apply to Charges that are not calculated by **connection location** and cannot reasonably be related to one or more particular **connection locations**.

10.4 **Incorrect Invoices:**

If within 24 months from the date of any invoice Transpower discovers that it has overcharged or undercharged the Customer (whether because it has incorrectly calculated any Charge or because it has used an incorrect input when calculating a Charge), Transpower will:

(a) **Undercharge:**

in the case of an undercharge, invoice the Customer under clause 10.1 for the amount of the undercharge together with interest at the Interest Rate calculated from the Due Date of the incorrect invoice to the Due Date of the invoice showing the undercharge (provided that if the undercharge was due to incorrect information provided by the Customer, interest shall be at the Default Rate); and

(b) **Overcharge:**

in the case of an overcharge, send the Customer a credit note together with the next invoice under clause 10.1, for the amount of the overcharge together with interest at the Default Rate calculated from the Due Date of the incorrect invoice to the Due Date of that next invoice (provided that if the overcharge was due to incorrect information provided by the Customer, interest shall be at the Interest Rate). If the amount of the overcharge plus interest exceeds the amount of the Charges due that month, Transpower will pay to the Customer such excess amount on or before the Due Date of that next invoice.

10.5 **Manifest Error In Invoice:**

If the Customer considers that there is a manifest error in an invoice and gives Transpower not less than five Business Days' notice of the alleged error prior to the Due Date, Transpower must use reasonable endeavours to investigate

whether there is a manifest error and notify the Customer before the Due Date whether it agrees (acting reasonably) that there is a manifest error and the invoice requires correction.

If:

- (a) Transpower notifies the Customer that it agrees that there is a manifest error requiring correction, it will re-invoice the Customer and, without prejudice to the Customer's rights to dispute the new invoice under clause 10.6(b), clause 11 will apply to payment of the new invoice, provided that the Due Date will be five Business Days from the date that the new invoice is received by the Customer, and the Customer will not be liable to pay the sum specified in the incorrect invoice;
- (b) Transpower notifies the Customer that it does not agree that there is a manifest error requiring correction, clause 11 will apply to payment of the invoice and (if the Customer wishes) the Customer may notify Transpower of a dispute pursuant to clause 10.6(b);
- (c) Transpower has not notified the Customer before the Due Date either that it agrees or disagrees that there is a manifest error requiring correction, that invoice will not be payable provided that if the Customer subsequently receives notice from Transpower that it:
 - (1) agrees that there is a manifest error requiring correction, clause 10.5(a) will apply; or
 - (2) disagrees that there is a manifest error requiring correction, the Due Date for that invoice will be five Business Days from the date the Customer receives such notice and the Customer may notify Transpower of a dispute pursuant to clause 10.6(b).

10.6 Disputed Invoices:

Subject to clause 10.7, if the Customer disputes any matter relating to an invoice (including on the basis Transpower has incorrectly calculated any Charge or has used an incorrect input when calculating a Charge), the Customer must:

(a) **Continuing Obligation to Pay:**

pay the full amount of the disputed invoice in accordance with clauses 11.1, 11.2 and 11.3; and

(b) **Notice:**

within 24 months from the date of receipt of the invoice, notify Transpower of the dispute, including the grounds of dispute, in accordance with clause 21.3. Payment of a disputed invoice in accordance with clause 11.1 is without prejudice to the Customer's right to notify a dispute under this clause 10.6(b) or to raise any arguments in relation to such dispute.

10.7 Payment Following Dispute Resolution:

If, as a result of a dispute notified pursuant to clause 10.6, it is agreed or determined that Transpower has overcharged or undercharged the Customer, the procedure for undercharges or overcharges (as the case may be) in clause 10.4 will apply.

10.8 Waiver of Right to Dispute or to Invoice an Undercharge:

(a) Disputed Invoice:

The Customer will be deemed to have irrevocably waived its right to dispute any matter relating to an invoice (including on the basis Transpower has incorrectly calculated any Charge or has used an incorrect input when calculating a Charge) if the Customer fails to give a Dispute Notice and provide details of the grounds for the dispute as specified in clause 21.3 within 24 months from the date of the disputed invoice.

(b) Undercharge:

Transpower will be deemed to have irrevocably waived its right to invoice the Customer for any undercharged amount if Transpower fails to invoice the amount of the undercharge as specified in clause 10.4(a) within 24 months from the date of the incorrect invoice.

11. PAYMENT

11.1 Payment:

The Customer must pay to Transpower the full amount of any invoice sent in accordance with this Agreement. No deduction from the amounts invoiced may be made, except that if the Customer has received a credit note from Transpower with the invoice, the Customer may deduct the amount of the credit note from the amount payable under the invoice. For the purposes of this clause 11.1, "deduction" means any legal or equitable set off, and/or any legal or equitable counterclaim, and/or any cross-demand and/or any other legal or equitable claim and/or any disputed amount.

11.2 Date for Payment:

Any invoice under this Agreement must be paid in full on or before the Due Date. Except as otherwise provided in this Agreement, "Due Date" means the later of:

- (a) the 20th day of the month in which the invoice is issued or the next Business Day if the 20th day of the month is not a Business Day; and
- (b) five Business Days from the date the invoice is received by the Customer (including the day of receipt as the first Business Day if the invoice is received prior to 10.00 am on a Business Day).

11.3 **Time for Payment:**

If the Customer makes payment of an amount:

(a) **Electronic Payment:**

by electronic transfer of funds:

- (1) the payment must be credited to Transpower's designated bank account (as provided by Transpower under clause 12.10(2)(b) or 12.13 of the Code) by midnight on the Due Date; and
- (2) the Customer is to notify Transpower of any payment by electronic transfer of funds prior to 10.00 am on the day of transfer;

or

(b) **Other Means of Payment:**

by any other means, the payment must be made before 2.00 pm on the Due Date and the Customer is by the same time to notify Transpower of the payment and the invoice to which it relates.

11.4 **Default Interest:**

If the Customer fails to pay the full amount of any invoice which is due in accordance with this Agreement on or before the Due Date, the Customer must pay interest calculated at the Default Rate on the amount unpaid from the Due Date until the date payment is received by Transpower, such interest to accrue after, as well as before, judgment, award or determination.

11.5 **GST Amount:**

In addition to any amounts payable under this Agreement, the Customer is to pay Transpower an amount equal to any GST for which Transpower is liable in respect of the supply to which such payments relate (the "GST Amount"). The GST Amount is due and payable by the Customer at the same time as the payment in respect of which it is payable is due under this Agreement.

12. **PARTIES TO PROVIDE INFORMATION**

12.1 **Information Required by Transpower or the Customer:**

Without limiting any other provision of this Agreement, each party is to provide the other party (the "Requesting Party") with any information and within such time as the Requesting Party may reasonably require for the purposes of performing its obligations under this Agreement, or its obligations under any Law in so far as such obligations relate to the performance of this Agreement, including information about:

(a) **Assets:**

the party's **assets**;

- (b) **Operation of Assets:**
the operation of the party's **assets**;
- (c) **Conveyed Electricity:**
any metered quantities of **electricity** conveyed; and
- (d) **Demand or Supply:**
anticipated supply of, or demand for, **electricity**.

13. FORCE MAJEURE

13.1 Force Majeure:

If either party fails to comply with or observe any provision of this Agreement (other than payment of any amount due) and such failure is caused by:

- (a) **Specific Events or Circumstances:**
any event or circumstance occasioned by, or in consequence of, any act of God (being an event or circumstance (i) due to natural causes, directly or indirectly and exclusively without human intervention, and (ii) which could not reasonably have been foreseen or, if foreseen, could not reasonably have been resisted), strikes, lockouts, other industrial disturbances, acts of public enemy, wars, terrorism, blockades, insurrections, riots, epidemics, or civil disturbances;
- (b) **Court Orders etc:**
the binding order of any court, government, regulatory body or a local authority beyond the control of the party invoking this clause 13.1; or
- (c) **Other Event or Circumstance:**
any other event or circumstance beyond the control of the party invoking this clause 13.1,

and being such that, by taking reasonable precautions in accordance with Good Electricity Industry Practice, such party could not have avoided the effect of such event or circumstance, that failure does not give rise to any cause of action or liability based on default of the provision.

13.2 Notice:

If a party becomes aware of a serious prospect of a forthcoming Force Majeure, it must notify the other party as soon as reasonably practicable of the particulars of which it is aware. If a party invokes clause 13.1, it must notify the other party as soon as reasonably practicable of full particulars of the Force Majeure relied upon.

13.3 Avoidance and Mitigation of Effect of Force Majeure:

The party invoking clause 13.1 must:

(a) Endeavour to Avoid or Overcome:

use all reasonable endeavours to overcome or avoid the Force Majeure;

(b) Endeavour to Mitigate:

use all reasonable endeavours to mitigate the effects or consequences of the Force Majeure insofar as such causes the failure in respect of which clause 13.1 has been invoked; and

(c) Consult:

consult with the other party on the performance of the obligations referred to in clause 13.3(a) and 13.3(b).

13.4 No Obligation to Settle:

Nothing in clause 13.3 is to be construed as requiring a party to settle a strike, lockout or other industrial disturbance by acceding, against its judgement, to the demands of opposing parties.

14. DANGER TO PERSONS AND PUBLIC SAFETY

14.1 Danger to Persons and Public Safety:

Notwithstanding any other provisions of this Agreement, if Transpower considers in good faith that there is an immediate danger to persons or public safety, it may immediately and without notice to the Customer de-energise any Point of Connection or take any other steps necessary in accordance with Good Electricity Industry Practice to avoid or minimise that danger. Transpower will notify the Customer as soon as reasonably practicable of the de-energisation and the reasons for de-energisation and will re-energise the Point of Connection as soon as practicable after it becomes safe to do so.

15. CONSEQUENCES OF DEFAULT

15.1 Non-Payment:

If the Customer fails to pay any invoice which is due to Transpower under this Agreement in full and on or before the Due Date, the following provisions apply:

(a) **Notice:**

Transpower may give notice to the Customer stating the amount due and requiring payment.

(b) **Transpower's Rights:**

If the Customer does not pay the amount due, together with interest calculated under clause 11.4, within five Business Days from the date of receipt of the notice under clause 15.1(a), Transpower may, without prejudice to any other right it may have at law or under this Agreement and while the non-payment (including non-payment of interest) continues:

(1) if the non-payment relates to either Part B: Point Connection or Part C: Grid Connection, give 10 Business Days' notice of its intention to do any or all of the following:

- A. de-energise all or any Points of Connection;
 - B. terminate Part B: Point Connection and Part C: Grid Connection in whole or in respect of any Point of Connection; and
 - C. terminate the whole of this Agreement,
- provided that if the unpaid Charges relate only to a particular **connection location**, or particular **connection locations**, then A and B above will only apply in respect of Point(s) of Connection at such **connection location(s)** and C above will not apply,

and

(2) if the non-payment relates to any Part other than Part B: Point Connection or Part C: Grid Connection, give 10 Business Days' notice of its intention to do either or both of the following:

- A. terminate that Part; or
- B. terminate the whole of this Agreement.

(c) **Meet to Discuss**

As soon as practicable after a notice under clause 15.1(a) has been given, the parties will meet to discuss payment. Transpower may only act on its intention to act under clause 15.1(b)(1)A, B or C or (2)A or B following the expiry of 10 Business Days from the date of receipt of the notice by the Customer if no agreement has been reached on payment or the Customer has been unwilling to meet with Transpower prior to the expiry of the 10 Business Days.

(d) **Further Notice**

If the Customer fails to comply with any agreement reached under clause 15.1(c), then:

- (1) Transpower may give a further notice under clause 15.1(b) as if the failure to comply with the agreement was a failure to pay the amount due together with interest within five Business Days from the date of receipt of the notice under clause 15.1(a); and
- (2) clause 15.1(c) shall not apply in respect of such notice.

(e) **Exercise of Rights**

Subject to the proviso to clause 15.1(b)(1), Transpower may exercise its rights to terminate under clause 15.1(b)(1)B in respect of any Point of Connection notwithstanding that it may have already exercised its rights under that clause in respect of any other Point of Connection or have already exercised its rights under clause 15.1(b)(1)A, whether in respect of that or any other Point of Connection.

15.2 Customer Technical Non Compliance:

If the Customer fails to comply with any Technical Compliance Obligation, the following provisions apply (without prejudice to any other rights or remedies that Transpower may have at law or under this Agreement):

(a) **Immediate de-energisation:**

- (1) Acting in accordance with Good Electricity Industry Practice, Transpower may immediately de-energise any Point of Connection to which the non-compliance relates for so long as it reasonably considers that the non-compliance is likely to have a material adverse effect on:

the power quality or security of the **grid**;
the performance characteristics and/or management of the **grid**; or
any other Connected Party.

- (2) Transpower will notify the Customer as soon as reasonably practicable of the de-energisation and the reasons for the de-energisation (including the nature of the Customer's non compliance).
- (3) Where Transpower is unable to de-energise the Point of Connection to which the non-compliance relates, the Customer must de-energise the Point of Connection as soon as practicable following receipt of a notice from Transpower requiring de-energisation under this clause 15.2(a). Such notice shall include the reasons for the de-energisation (including the nature of the Customer's non-compliance).
- (4) Transpower may exercise its rights under this clause 15.2(a) notwithstanding that any notice may have been given or process commenced under clause 15.2(b) or clause 15.3.

(b) **Notice of Non-Compliance:**

Transpower may give notice to the Customer specifying the non-compliance and, if Transpower does so:

- (1) the Customer must remedy the non-compliance within 10 Business Days from the date of receipt of the notice; or
- (2) if it is not reasonably practicable in accordance with Good Electricity Industry Practice for the Customer to remedy the non-compliance within 10 Business Days from the date of receipt of the notice, the Customer must provide Transpower with a plan (including a timetable) to remedy the non-compliance in accordance with Good Electricity Industry Practice. If Transpower does not agree with the Customer's remedial plan, the remedial plan is to be referred to an expert for determination in accordance with clause 21.6.

15.3 De-energisation or Termination:

If, following receipt of a notice under clause 15.2(b), the Customer:

- (a) fails to remedy the non-compliance or to provide Transpower with a remedial plan within 10 Business Days from the date of receipt of the notice; or
- (b) fails to remedy the non-compliance in accordance with the remedial plan (as agreed or determined),

then while the failure continues Transpower may give 10 Business Days' notice of its intention to do any or all of the following:

- (c) de-energise any Point of Connection to which the non-compliance relates; or
- (d) terminate Part B: Point Connection and Part C: Grid Connection in relation to any Point of Connection to which the non-compliance relates.

As soon as practicable after such a notice has been given, the parties must meet and:

- (e) if clause 15.3(a) applies, negotiate in good faith as to the steps the Customer will take to remedy the non-compliance having regard to Good Electricity Industry Practice; or
- (f) if clause 15.3(b) applies, in good faith seek to identify the reasons why the Customer has not complied with the remedial plan and negotiate any necessary changes to the remedial plan.

Transpower may only act on its notice of intention following the expiry of 10 Business Days from the date of receipt of the notice by the Customer if no agreement can be reached on the matters described in clauses 15.3(e) or (f) (as applicable) or the Customer has been unwilling to meet with Transpower before the expiry of 10 Business Days. If the Customer fails to comply with any agreement reached under clauses 15.3(e) or (f) Transpower may by giving not less than 10 Business Days' notice, do all or any of the following:

- (g) de-energise any Point of Connection to which the non-compliance relates;
or
- (h) terminate Part B: Point of Connection and Part C: Grid Connection in relation to any Point of Connection to which the non-compliance relates.

Transpower may exercise any of its rights under this clause 15.3 to de-energise or terminate any Point of Connection notwithstanding that it has also exercised any or all of those in respect of that or any other Point of Connection.

15.4 **Re-energisation:**

Where Transpower has exercised its rights under clause 15.2(a) or 15.3 to de-energise a Point of Connection and the Customer remedies the failure that gave rise to Transpower exercising such rights, Transpower will re-energise that Point of Connection as soon as practicable following receipt of a notice from the Customer that it has remedied such failure.

15.5 **Transpower Technical Non-Compliance:**

If Transpower fails to comply with any Technical Compliance Obligation, the following provisions apply:

(a) **Notice:**

The Customer may give notice to Transpower specifying the non-compliance.

(b) **Customer's Rights:**

If Transpower does not remedy or remove the non-compliance within 10 Business Days from the date of receipt of the notice specifying the non-compliance, the Customer may, without prejudice to any rights it may have at law or under this Agreement (including the dispute resolution procedures under clause 21) terminate Part B: Point Connection and Part C: Grid Connection in relation to any Point of Connection to which the non-compliance relates.

(c) **Equitable Relief:**

Notwithstanding clause 15.5(b), Transpower:

- (1) acknowledges that termination under clause 15.5(b) will not be an adequate remedy for Transpower's failure to comply with a Technical Compliance Obligation if there are no alternative transmission service providers; and
- (2) agrees that the Customer will (without prejudice to any rights it may have in law or under this Agreement) be entitled to equitable relief, including specific performance, in the event of a failure by Transpower to remedy or remove the non-compliance within 10

Business Days from the date of receipt of the notice specifying the non-compliance.

16. CONSEQUENCES OF DE-ENERGISATION

If Transpower de-energises a Point of Connection at a **connection location** in accordance with this Agreement:

(a) **Customer's Continuing Obligations:**

the de-energisation will not relieve the Customer of any obligation to pay any continuing Charges in relation to the **connection location**;

(b) **Indemnity:**

if the de-energisation is effected at the Customer's request or due to a breach by the Customer of its obligations under this Agreement, the Customer fully indemnifies Transpower for all Transpower's reasonable direct costs resulting from the de-energisation; and

(c) **Disclosure:**

Transpower and the Customer are relieved from any obligation of confidentiality owed to the other party (whether under this Agreement or otherwise) not to disclose the fact of the de-energisation or the reason for the de-energisation (including, where the de-energisation arises as a result of the direction of any third party, both the fact of the direction and the circumstances giving rise to such direction).

17. TERMINATION BY CUSTOMER ON NOTICE

Subject to clause 19.1, the Customer may at any time terminate Part B: Point Connection and Part C: Grid Connection in whole or in respect of any Point of Connection by giving Transpower not less than six months' notice of termination.

18. TERMINATION FOR INSOLVENCY OR ILLEGALITY

Either party may terminate this Agreement immediately by notice to the other party if:

(a) **Liquidation:**

the other party enters into liquidation, except for the purposes of a solvent reconstruction or amalgamation which is on terms previously approved in writing by the first party (not to be unreasonably withheld); or

(b) **Compromise:**

except as previously approved in writing by the first party, the other party enters into any compromise, arrangement or assignment with, or for the benefit of, its creditors whether approved by the Court or not; or

(c) **Statutory Management, Receivership or Administration:**

a statutory manager is appointed under the Corporations (Investigation and Management) Act 1989 to the other party or a receiver and/or manager or administrator is appointed to the whole or a material part of the other party's property; or

(d) **Insolvency:**

the other party is unable to pay its debts as they fall due in the normal course of business or where the value of the other party's assets is less than the value of its liabilities, including contingent liabilities; or

(e) **Other:**

the other party is not a company and it is the subject of an event reasonably analogous to any event described in clauses 18(a) to (d); or

(f) **Illegality:**

despite the operation of clause 24.4, it becomes illegal for either party to perform any provision of this Agreement to an extent which is material but:

- (1) subject to either party having first given notice and the parties having met and considered any practical basis on which this Agreement might be varied; and
- (2) provided that a party may not invoke this clause 18(f) if the illegality arises as a result of a failure by that party to meet its obligations under this Agreement or to comply with Good Electricity Industry Practice.

19. GENERAL PROVISIONS CONCERNING TERMINATION

19.1 Condition of Termination by Customer:

Any termination by the Customer of Part B: Point Connection and Part C: Grid Connection, whether in whole or in respect of any Point of Connection, will not be effective unless and until:

(a) **Disconnection:**

the Customer causes the Customer's Assets to be disconnected from the **grid** or, if the termination is in respect of any Point of Connection, causes the Customer's Assets at that Point of Connection to be disconnected from the **grid**; or

(b) **Terms:**

the Customer and Transpower agree terms for connection to the **grid** as a replacement for Part B: Point Connection and Part C: Grid Connection (including general terms) or a **default transmission agreement** applies in accordance with clause 12.13 of the Code).

19.2 Termination of a Point of Connection:

Where Part B: Point Connection and Part C: Grid Connection are terminated in respect of any Point of Connection at a **connection location**:

(a) **Schedules Amended:**

Schedule 1 (Points of Connection) and Schedule 2 (Points of Service) are deemed to be amended accordingly with effect from such termination;

(b) **Transpower to Forward Revised Schedules:**

within 20 Business Days from the date of such termination, Transpower is to forward to the Customer a revised Schedule 1 (Points of Connection), a revised Schedule 2 (Points of Service), and (if the Grid Charges are recalculated as a result of the termination) a revised Schedule 3 (Grid Charges), as necessary.

19.3 Consequences of Termination:

If Part B: Point Connection and Part C: Grid Connection terminate in whole or in respect of any Point of Connection (for any reason in accordance with this Agreement), then, as a provision which survives such termination, Transpower may:

(a) **Termination in Whole:**

if Part B: Point Connection and Part C: Grid Connection terminate in whole, do any or all of the following:

- (1) de-energise any or all Points of Connection; and
- (2) disconnect the Customer's Assets from any or all Points of Connection;

and

(b) **Termination in Respect of a Point of Connection:**

if Part B: Point Connection and Part C: Grid Connection terminate in respect of any Point of Connection, do any or all of the following:

- (1) de-energise each such Point of Connection; and
- (2) disconnect the Customer's Assets from the **grid** at each such Point of Connection.

Clauses 19.3(a) and 19.3(b) will not apply in relation to any Point of Connection in respect of which Transpower and the Customer agree, prior to the termination taking effect, terms for connection to the **grid** as a replacement for Part B: Point Connection and Part C: Grid Connection (including general terms).

19.4 Termination of Part A etc:

If Part B: Point Connection and Part C: Grid Connection have terminated in respect of all Points of Connection and there are no other Parts of this Agreement in force, the whole of this Agreement will be deemed to be terminated.

19.5 Rights not Affected by Termination:

Termination of this Agreement or of any Part, whether in whole or in respect of any Point of Connection, (for any reason in accordance with this Agreement) will not of itself affect:

(a) Liability for Preceding Default:

a liability of either party for any preceding default, including any default which gave rise to termination;

(b) Indemnity:

any indemnity given by either party to the other under this Agreement for any liability arising under such indemnity prior to, or that relates to or results from, termination, irrespective of whether or not any claim has been made under the indemnity prior to termination;

(c) Recovery of Amount Due:

the right of either party to recover from the other party any amount which is or may become due to it under this Agreement; and

(d) Rights and Remedies:

any other rights and remedies to which either party would otherwise be entitled, whether under this Agreement, at law, at equity or otherwise,

subject in each case to clause 20.

19.6 Certain Provisions Survive Termination:

Termination of this Agreement for any reason will not affect clauses 19, 20, 21 and 22 or those clauses which are expressed as being intended to survive such termination.

19.7 Limit on Right to Terminate:

Neither Transpower nor the Customer is entitled to terminate or cancel this Agreement except in accordance with, and as expressly provided in, this Agreement. To avoid doubt, neither party may cancel this Agreement under Subpart 3 of Part 2 of the Contract and Commercial Law Act 2017.

20. LIABILITY

20.1 Exclusion From Transpower's Liability:

Transpower and its Associates will only be liable (in contract, tort (including negligence), equity or otherwise) to the Customer for any loss, injury, damage (in each case whether direct, indirect or consequential) or expense (together "Loss"), if such Loss is caused by an act or omission of Transpower or its Associates which constitutes a failure by Transpower to comply with a provision of this Agreement. Transpower and its Associates will not be liable to the extent the act or omission was caused or contributed to by any default of the Customer or its Associates of its obligations under this Agreement.

20.2 Limitation of Transpower's Liability:

Subject to clauses 20.9 and 22.5, if Transpower or its Associates are liable to the Customer (whether in contract, tort (including negligence), equity or otherwise), other than for payment of amounts due or under any indemnity, Transpower and its Associates will only be liable for direct loss to the Customer excluding:

- (a) **Loss:**
any loss of use, revenue or profit by the Customer; and
- (b) **Damages:**
the amount of any damages awarded against the Customer in favour of a third party; and
- (c) **Settlement Money:**
the amount of any money paid by the Customer by way of settlement to a third party; and
- (d) **Costs or Expenses:**
any costs or expenses of the Customer incurred in connection with any of clauses 20.2(a), (b) or (c).

20.3 Transpower's Capped Liability:

Subject to clauses 20.9, 20.10 and 22.5, the combined maximum liability of Transpower and its Associates under this Agreement will be:

- (a) **Single Event or Series of Related Events:**
for any single event or related series of events, five million dollars; and
- (b) **12 Month Period:**
in any 12 month period a total of 20 million dollars, irrespective of the number of events.

20.4 Privity:

The benefits of clauses 20.1, 20.2, and 20.3 are intended to extend to Transpower's Associates and to be enforceable by each of them under Subpart 1 of Part 2 of the Contract and Commercial Law Act 2017.

20.5 Exclusion from Customer's Liability:

The Customer and its Associates will only be liable (in contract, tort (including negligence), equity or otherwise) to Transpower for any Loss, if such Loss is caused by an act or omission of the Customer or its Associates which constitutes a failure by the Customer to comply with a provision of this Agreement. The Customer and its Associates will not be liable to the extent the act or omission was caused or contributed to by any default of Transpower or its Associates of its obligations under this Agreement.

20.6 Limitation of Customer's Liability:

Subject to clauses 20.9 and 22.5, if the Customer or its Associates are liable to Transpower (whether in contract, tort (including negligence), equity or otherwise), other than for payment of amounts due or under any indemnity, the Customer and its Associates will only be liable for direct loss to Transpower excluding:

(a) **Loss:**

any loss of use, revenue or profit by Transpower; and

(b) **Damages:**

the amount of any damages awarded against Transpower in favour of a third party; and

(c) **Settlement Money:**

the amount of any money paid by Transpower by way of settlement to a third party; and

(d) **Costs or Expenses:**

any costs or expenses of Transpower incurred in connection with any of clauses 20.6(a), (b) or (c).

20.7 Customer's Capped Liability:

Subject to clauses 20.9 and 22.5, the combined maximum liability of the Customer and its Associates will be:

(a) **Single Event or Series of Related Events:**

for any single event or related series of events, five million dollars; and

(b) **12 Month Period:**

in any 12 month period a total of 20 million dollars, irrespective of the number of events.

20.8 Privity:

The benefits of clauses 20.5, 20.6, and 20.7 are intended to extend to the Customer's Associates and to be enforceable by each of them under Subpart 1 of Part 2 of the Contract and Commercial Law Act 2017.

20.9 Wilful Breach or Fraud:

The limits on liability in clauses 20.2, 20.3, 20.6 and 20.7 will not apply to a party for any wilful breach or fraud by that party.

20.10 Consumer Guarantees Act 1993:

- (a) Transpower fully indemnifies the Customer against all loss, damage, liability, claims or expense suffered or incurred by the Customer that arises under the Consumer Guarantees Act 1993 to the extent caused by any breach of this Agreement by Transpower (except to the extent the loss, damage, liability, claim or expense was due to a failure by the Customer to comply with clause 20.10(c)).
- (b) The limit on liability in clause 20.3 will not apply to any liability under this clause 20.10.
- (c) The Customer shall include a provision in any agreement with a consumer to exclude the Consumer Guarantees Act 1993 where the consumer acquires services from the Customer for the purposes of a business.

21. DISPUTE RESOLUTION

21.1 Exceptions:

This clause 21 will not apply to:

- (a) **Non-payment:**
actions for non-payment of invoices or demands; or
- (b) **Reconciled Quantities:**
disputes as to **reconciled quantities**; or
- (c) **Other:**
 - (1) disputes under the Code; or
 - (2) disputes in relation to which the Code sets out a dispute resolution process.

(d) **Transmission Pricing Methodology:**

matters arising under the **transmission pricing methodology** which are to be determined by an independent expert under the **transmission pricing methodology**.

21.2 **Management and Resolution of Disputes Between the Parties:**

The provisions of this clause 21.2 will apply to all disputes between the parties in relation to this Agreement:

(a) **Amicable resolution:**

the parties acknowledge that they are in a long-standing business relationship and recognise the importance of resolving disputes arising out of this Agreement between them quickly and cost effectively;

(b) **Interest Based:**

disputes will be resolved by focusing on the interests of both parties to achieve an agreed solution;

(c) **Reasonable Efforts:**

the parties will use all reasonable endeavours to resolve any dispute;

(d) **Obligation to Resolve Remains:**

the parties are to continue to seek to resolve any dispute by consultation and negotiation whether or not any dispute is referred for mediation, expert determination, arbitration, litigation or is referred to the **Rulings Panel**;

(e) **Continued Performance:**

pending resolution of any dispute, the parties are to continue to perform their obligations under this Agreement; and

(f) **Agreement:**

any agreement to resolve any dispute is to be in writing and signed by each party.

21.3 **Dispute Notice and Meeting:**

The following provisions of this clause 21.3 will apply to any dispute in relation to this Agreement:

(a) **Dispute Notice:**

the party claiming a dispute is to give prompt and early notice of the dispute to the other party (the "Dispute Notice") and will provide the grounds for the dispute within five Business Days from the date of receipt of the Dispute Notice. The party receiving the Dispute Notice is to give a

response notice within five Business Days from the date of receipt of the grounds for the dispute;

(b) **Dispute Meeting:**

the parties are to meet within 15 Business Days from the date of receipt of the Dispute Notice (the "Dispute Meeting"). At the Dispute Meeting, the parties are to seek to:

- (1) identify and agree the interests of each party;
- (2) identify and isolate the issues between the parties;
- (3) where possible, resolve the dispute;
- (4) if the parties cannot resolve the dispute, identify whether any further information is required by either party and agree a time within which the information will be provided; and
- (5) if not otherwise provided in this Agreement,

determine the most appropriate method for resolving the dispute. Such methods may include:

- (6) negotiation;
- (7) non-binding neutral evaluation by a third party;
- (8) expert determination;
- (9) mediation;
- (10) arbitration;
- (11) litigation; or
- (12) any other method agreed between the parties;

(c) **Timetable:**

at the Dispute Meeting, the parties must agree a timetable to endeavour to resolve the dispute. Where practicable, the timetable is to provide for the dispute to be resolved within six weeks from the date of the Dispute Meeting unless the dispute is to be resolved by litigation;

(d) **No Agreement on Dispute Process:**

if the parties cannot reach agreement at the Dispute Meeting on the method for resolving the dispute then either party may refer the dispute to arbitration. The provisions of clause 21.5 will apply to any such arbitration;

(e) **Dispute Process Breaks Down:**

except in the case of arbitration, expert determination or litigation, if a process for resolving a dispute is agreed but a party considers that the agreed process has broken down, then the party may refer the dispute to

arbitration. The provisions of clause 21.5 will apply to any such arbitration; and

(f) **Refusal to meet:**

if, following receipt of a Dispute Notice, either party refuses to meet or for any other reason the parties fail to have a Dispute Meeting within 15 Business Days from the date of receipt of the Dispute Notice and the dispute remains unresolved, then either party may refer the dispute to arbitration. The provisions of clause 21.5 will apply to any such arbitration.

21.4 Mediation:

Where the parties agree that a dispute is to be referred to mediation, the provisions of this clause 21.4 will apply:

(a) **Appointment of Mediator:**

the parties are to agree the appointment of a mediator within five Business Days from the date of the Dispute Meeting;

(b) **Default Appointment:**

if a mediator is not appointed under clause 21.4(a), either party may request the president for the time being of the Arbitrators' and Mediators' Institute of New Zealand Incorporated to appoint the mediator;

(c) **Mediator to Settle Procedures:**

the mediator is to consult with the parties to settle the timetable and procedures to be adopted during the mediation within five Business Days from the date of the mediator's appointment. The mediator may call any meeting between the parties at such times and places as the mediator considers appropriate. The mediation must be held within 25 Business Days from the date of the mediator's appointment;

(d) **Parties to Attend Meetings:**

the parties are to attend all meetings called by the mediator and use all reasonable endeavours to assist the mediation;

(e) **Legal Representation:**

the parties may have the assistance of legal counsel;

(f) **Without Prejudice:**

the mediation is to be conducted on a "without prejudice" basis. The mediation will not affect the rights, or prejudice the position, of the parties to the dispute in any subsequent proceedings of any kind;

(g) **Mediator has no Power of Decision:**

the mediator has no power of decision on any matters;

(h) **Mediator's Costs to be Borne Equally:**

the mediator's costs are to be paid equally by the parties and the parties will be jointly and severally liable to the mediator for such costs. This clause 21.4(h) confers a benefit or right on the mediator and is intended to be enforceable by the mediator under Subpart 1 of Part 2 of the Contract and Commercial Law Act 2017; and

(i) **Parties' Costs of the Mediation:**

each party will bear its own costs and expenses (including legal costs on a solicitor-client basis).

21.5 Arbitration:

Where the parties agree that a dispute is to be referred to arbitration, or a party refers a dispute to arbitration under any provision of this Agreement, the dispute will be referred to arbitration in accordance with the Arbitration Act 1996 and the provisions of this clause 21.5 will apply:

(a) **Single Arbitrator:**

the arbitration is to be conducted by a single arbitrator;

(b) **Appointment of Arbitrator:**

the parties are to agree the appointment of the arbitrator within five Business Days from the date of the Dispute Meeting;

(c) **Default Appointment:**

if an arbitrator is not appointed under clause 21.5(b), either party may request the president for the time being of the Arbitrators' and Mediators' Institute of New Zealand Incorporated or his or her nominee to appoint the arbitrator;

(d) **Notice of Appointment:**

the arbitrator is to give the parties notice of his or her appointment;

(e) **Final and Binding:**

the award in the arbitration will be final and binding upon the parties;

(f) **Give Reasons:**

the arbitrator is to provide reasons for any award made;

(g) **Costs:**

unless the parties otherwise agree, costs are to be determined by the arbitrator's final award; and

(h) **Interim Payment of Arbitrator's Costs:**

pending the final award, the fees and expenses of the arbitrator, including hire fees and facilities expenses, are to be paid equally by the parties and the parties will be jointly and severally liable to the arbitrator for such fees and expenses. This clause 21.5(h) confers a benefit or right on the arbitrator and is intended to be enforceable by the arbitrator under Subpart 1 of Part 2 of the Contract and Commercial Law Act 2017.

21.6 Expert Determination:

Where the parties agree, or this Part requires, that a dispute is to be referred to an independent expert, the provisions of this clause 21.6 will apply:

(a) **Appointment of Expert:**

the parties are to agree on the appointment of an expert within five Business Days from the date of the Dispute Meeting;

(b) **Default Appointment:**

if an expert is not appointed under clause 21.6(a), either party may request the president for the time being of the New Zealand Law Society to make the appointment;

(c) **Notice of Appointment as Expert:**

the expert is to give the parties notice of his or her appointment;

(d) **Representations:**

the expert is to invite the parties to submit such representations as the parties wish to make within 10 Business Days from the date of receipt of the expert's notice of appointment. The expert is to take into account any representations submitted by the parties but is not limited or fettered by them in any way;

(e) **Expert not Arbitrator:**

the expert is to act as an expert and not as an arbitrator and, accordingly, the Arbitration Act 1996 does not apply;

(f) **Inspection of Records:**

the expert may inspect any relevant records kept by a party in relation to this Agreement at any reasonable time provided that:

- (1) a party is not obliged to provide records for inspection where to do so will breach an obligation owed by that party to a third party or is contrary to law; and
- (2) each party is to use reasonable endeavours to obtain any consent necessary to disclose information requested by the expert;
- (g) **Rely on Own Judgement:**
the expert is entitled to rely on his or her own judgement and opinion;
- (h) **Give Reasons:**
the expert is to provide the reasons for any determination within six weeks from the date of the expert's appointment or within such extended period as the parties may agree. The expert is not to release any determination to the parties until the expert's fees and expenses are paid;
- (i) **Binding Determination:**
the expert's determination will be final and binding upon the parties;
- (j) **Replacement of Expert:**
if the expert does not make a determination within six weeks from the date of his or her appointment (or within the time agreed by the parties), or relinquishes his or her appointment, or dies, or for any other reason is unable to complete the determination, another expert will be appointed. This clause 21.6 will apply in relation to that appointment;
- (k) **Expert's fees:**
the expert's fees and expenses will be paid equally by the parties or as agreed or determined under clause 21.6(l) or (m) respectively, and the parties will be jointly and severally liable to the expert. This clause 21.6(k) confers a benefit or right on the expert and is intended to be enforceable by the expert under Subpart 1 of Part 2 of the Contract and Commercial Law Act 2017;
- (l) **Costs:**
the parties are to agree which party will pay the costs of the expert determination, including each party's costs and the expert's fees and expenses, within 10 Business Days from the date receipt of the determination; and
- (m) **Expert to Determine Costs:**
if the parties do not agree costs under clause 21.6(l), the expert is to determine such costs, fees and expenses. The expert may invite the parties to make submissions on costs in such manner as determined by the

expert. The parties will be bound by the expert's determination as to costs.

22. CONFIDENTIALITY

22.1 Confidentiality:

- (a) Except as expressly provided otherwise in this Agreement, each party is to keep confidential and only use for the purposes of this Agreement any information provided by or on behalf of the other party relating to this Agreement which has been specified by such party as being confidential information, and not disclose such information to any other person without the prior written consent of the other party, which is not to be unreasonably withheld.
- (b) Each party acknowledges that information it receives from the other party may be or become "inside information" or "material information" as defined by the Financial Markets Conduct Act 2013. Neither party shall use any such information in any way or otherwise do anything which could breach the Financial Markets Conduct Act 2013 or any listing rules (as defined in the Financial Markets Conduct Act 2013) or could result in the other party or any of its Related Companies or any of its or their shareholders, officers, employees or advisers incurring any liability under the Financial Markets Conduct Act 2013 or listing rules. In particular neither party shall, or shall cause or permit any person to whom it has disclosed the inside information and/or material information to, buy or sell or otherwise deal in shares in the other party or advise or encourage any other person to do so until all such information ceases to be inside information and/or material information.

22.2 Exceptions:

Clause 22.1 is not to apply to the disclosure of any information by a party:

- (a) **Associates:**

to its Associates or Related Companies where necessary for the ordinary business purposes of that party;

- (b) **Banks, etc.:**

to any bank, financial institution or rating agency from which the party is seeking to obtain or maintain financial facilities or a credit rating in connection with that party's business;

- (c) **Assignee:**

to a bona fide intending assignee who has signed a confidentiality agreement in favour of the party whose information is being disclosed;

(d) **As Required by Law or Stock Exchange:**

to any person to whom that party reasonably believes it is required to disclose to by law or to meet the listing requirements of any stock exchange;

(e) **Industry Agreements:**

to any person to whom that party reasonably believes it is required to disclose to so as to comply with (including the exercise of any rights under) the Code and, in the case of Transpower, to any person to whom it reasonably believes it is required to disclose to so as to comply with (including the exercise of any rights under) any **market operation service provider agreement**;

(f) **Disputes:**

in any mediation, arbitration, adjudication or legal proceeding of any kind arising out of or in connection with this Agreement or otherwise in compliance with the order of any court of competent jurisdiction;

(g) **Public Domain:**

to the extent that the information at the time of disclosure was, or subsequently has become, generally available to the public other than as a result of unauthorised disclosure by that party or any of its Associates;

(h) **Already Known:**

to the extent that the information was already known to a party at the time of disclosure and came into that party's possession otherwise than by breach of any confidentiality obligation owed to any other party or the information was disclosed to a party on a non-confidential basis by a third party who was not bound by any confidential obligation;

(i) **System Operator:**

to the System Operator to the extent required for performance of its functions;

(j) **Transpower Termination or De-energisation:**

in the relevant circumstances where Transpower is acting under clauses 14.1, 15.1(b), 15.2, 15.3 or 19.3; and

(k) **Customer Termination:**

in the relevant circumstances where the Customer is acting under clause 15.5.

22.3 Disclosure on Aggregated Basis:

Transpower may disclose confidential information to any person where the information has been developed into aggregated statistical data and such disclosure will not in a material manner commercially disadvantage the Customer.

22.4 Associates:

Each party is to ensure that its Associates or Related Companies who are in possession of any confidential information under clauses 22.2(a), 22.2(b), 22.2(c), 22.2(f) observe and comply with these confidentiality provisions and is responsible to the other party for any acts and omissions of its Associates or Related Companies in relation to the confidential information.

22.5 Liability:

The limits on liability in clauses 20.2, 20.3, 20.6 and 20.7 shall not apply to any breach by a party of its obligation under this clause 22 or clause 12 of schedule 7.

22.6 Survive Termination:

The whole of this clause 22 is to survive termination of this Agreement.

23. ASSIGNMENT

23.1 Assignment:

Neither party may assign, transfer or otherwise dispose of the whole or any part of its interest or obligations under this Agreement without the other party's prior written consent, not to be unreasonably withheld.

23.2 Release:

If either party assigns or transfers the whole of its interest or obligations under this Agreement in accordance with clause 23.1 the party assigning or transferring its interest will be relieved and released from its obligations and any liability under this Agreement except for any obligations or liability arising prior to the date of the assignment or transfer.

23.3 Deemed Assignment:

Except in the case of a party whose shares are listed on a recognised stock exchange, there is deemed to be an assignment of a party's interest in this Agreement in breach of clause 23.1 if, without the prior approval of the other party (not to be unreasonably withheld), by transfer or allotment of shares or amendment of its company constitution or by some other act or deed, the effective control of a party changes or passes to any person not having effective control as at the date of this Agreement.

24. GENERAL LEGAL TERMS

24.1 No Partnership, etc.:

This Agreement does not constitute either party as an agent or legal representative of the other or employee or servant of the other for any purpose nor does this Agreement deem to establish a joint venture or partnership.

24.2 No Representation:

The Customer acknowledges that it is not entering into this Agreement on the basis of any representation or warranty made by Transpower which is not expressly set out in this Agreement.

24.3 Amendments:

Except as expressly provided in this Agreement, there is to be no amendment to any of the provisions of this Agreement except by a supplementary written agreement signed by the parties.

24.4 Severability:

If any of the provisions of this Agreement are held by a court or tribunal of competent jurisdiction to be unenforceable, then that provision will be severed from this Agreement and immediately replaced with a valid enforceable provision as similar as possible to the severed provision.

24.5 Waiver:

No waiver, extension or excuse (as the case may be) will be deemed to arise unless it is in writing and signed by the relevant party providing it.

24.6 No Third Party Rights:

Except as expressly provided in this Agreement, the parties do not intend to create rights in or grant remedies to any third party as a beneficiary of this Agreement and all provisions contained in this Agreement are for the sole and exclusive benefit of the parties.

24.7 Further Acts:

Each party agrees that it will from time to time sign, execute, procure, pass and do all such further documents, acts, matters, resolutions and things within its power as may reasonably be necessary to effect the provisions of this Agreement.

24.8 Applicable Law:

This Agreement is to be governed by and interpreted in accordance with the laws of New Zealand and the parties hereto irrevocably submit to the non-exclusive jurisdiction of the Courts of New Zealand.

25. NOTICES

25.1 Delivery of Notices:

Except as expressly provided otherwise, all notices or other communication required by this Agreement must be in writing and must be forwarded by personal delivery, post, or email (if an email address for notices has been provided) to the number or address of the party set out in clause 1 or 2 (as the case may be) of Part A: Foundation or otherwise notified by that party from time to time. Subject to clause 25.2, any such notice or other communication will be deemed to have been duly received:

(a) **Personal Delivery:**

if personally delivered, when delivered at the recipient's address;

(b) **By Post:**

if sent by post, at 9.00am on the second Business Day after posting; or

(c) **By Email:**

if sent by email, when actually received in readable form by the recipient, provided that a delivery failure notice has not been received by the sender, in which case the notice or other communication will be deemed not to have been sent.

25.2 Not a Business Day:

Except for any notice or other communication deemed received under clause 25.1(b), if any notice or other communication is not received on a Business Day, or is not received before 10.00am on any Business Day, that notice or other communication will be deemed to have been duly received by the recipient at 9.00 am on the next Business Day.

25.3 Commencement of Notice Period:

Where this Agreement provides that an event or action take place within a specified number of Business Days from the date of receipt of any notice or other communication ("Notice Period"), the first Business Day of the Notice Period is deemed to be the day of receipt in accordance with clauses 25.1 and 25.2.

PART B: POINT CONNECTION

26. SCOPE OF POINT CONNECTION

This Part sets out the obligations of both Transpower and the Customer in relation to the physical connection of the Customer's Assets to the **grid**.

Connection of the Customer's Assets to the **grid** occurs at a Point of Connection and provides the physical means by which **electricity** can transfer between the **grid** and the Customer's Assets. The parties' rights and obligations in relation to energisation of a Point of Connection, which is necessary to effect the transfer of **electricity** between the Customer's Assets and the **grid**, are set out in Part C: Grid Connection.

27. DEFINITIONS

For the purposes of this Part B:

Equipment

includes equipment, tools, cables, machinery, lines, wires and all related materials and items;

Local Losses

means Losses applying to the conveyance of **electricity** over a Local Network;

Local Network

means lines, equipment and plant that is used to convey **electricity** between the **grid** and a **consumer** (other than a **direct consumer**) or **embedded generator** or **embedded network** who are connected to that Local Network;

Losses

means the difference between the delivered **electricity** at one place and the **electricity** required to be injected at any other place in order to supply the delivered **electricity**; and

Metering Information

means the quantity of **electricity** measured by a **metering installation** and adjusted for Local Losses (where relevant) to represent the equivalent amount of **electricity** at the relevant Point of Connection.

28. CONNECTION

28.1 Connection:

Transpower will permit the Customer to connect the Customer's Assets to the **grid** at the Points of Connection and to remain connected in accordance with

this Agreement for the purpose of enabling the transfer of **electricity** between the **grid** and the Customer's Assets.

28.2 Customer's Assets:

The Customer must ensure that connection of the Customer's Assets to the **grid** and the maintenance and operation of the Customer's Assets and any **assets** physically connected to the Customer's Assets do not adversely affect the **grid** or Transpower's use or management of the **grid**.

28.3 Transpower's Assets:

Transpower must ensure that connection of the **grid** to the Customer's Assets and the maintenance and operation of the **grid** and any **assets** physically connected to the **grid** do not adversely affect the Customer's Assets or the Customer's use or management of the Customer's Assets.

29. CONNECTION CODE

29.1 Transpower:

Transpower must comply with the obligations on it, and may exercise its rights under, the Connection Code.

29.2 Customer:

The Customer must comply with the obligations on it, and may exercise its rights under, the Connection Code.

30. INFORMATION

30.1 Information from Transpower:

Transpower will, at the request of the Customer, provide such information to the Customer about the electrical characteristics of the **grid** and the Points of Connection, or any maintenance or operation of the **grid**, as the Customer reasonably requires for the purposes of connecting the Customer's Assets to the **grid** and keeping them connected.

30.2 Information from Customer:

The Customer will, at the request of Transpower, provide such information to Transpower about the electrical characteristics of the Customer's Assets and any **assets** physically connected to the Customer's Assets, or any maintenance or operation of the Customer's Assets or any **assets** physically connected to the Customer's Assets, as Transpower reasonably requires for the purposes of this Agreement.

31. ACCESS

31.1 Access and Occupation Schedule:

Where:

- (a) at the Commencement Date, Equipment, and any structures related to that Equipment, that are owned or leased by the Customer are on Transpower property; and
- (b) Transpower and the Customer do not have a written agreement in place in relation to access and occupation for such Equipment and structures; and
- (c) such Equipment and structures are not “Existing Works” as defined in the Electricity Act 1992,

then the Customer's rights of access to and over Transpower's property will be in accordance with the terms set out in Schedule 6 (Access and Occupation).

31.2 Termination of this Part:

A termination of this Part B: Point Connection operates as a termination of the rights granted to the Customer under Schedule 6 (Access and Occupation).

31.3 Termination of a Point of Connection:

A termination of this Agreement in relation to a Point of Connection operates as a termination of the rights granted under Schedule 6 (Access and Occupation) relating to that Point of Connection.

31.4 Removal of Facilities on Termination:

If the rights granted under Schedule 6 (Access and Occupation) are terminated in whole or in part in accordance with clause 31.2 or 31.3, the Customer will have six months from the date of such termination to obtain access to the relevant Facilities Area (as that term is defined in Schedule 6 (Access and Occupation)) during normal business hours and on reasonable notice being given to Transpower for the purposes of removal of the relevant Facilities (as that term is defined in Schedule 6 (Access and Occupation)). Transpower is to provide all reasonable assistance to the Customer to enable the Customer to comply with its obligations under this clause 31.4.

32. METERING INSTALLATIONS

32.1 Metering Installations:

The Customer is to ensure that a **metering installation**, measuring the flow of **electricity** between the Customer's Assets and the **grid** and complying in all respects with the testing and any other requirements in the Code in relation to the accuracy, use and installation of the **metering installation**, is provided at or near each Point of Connection. This clause does not apply in respect of a Point of Connection for so long as Transpower provides a **metering installation** at or near that Point of Connection and the costs of providing that **metering installation** are included in the Grid Charges. Where Transpower provides a

metering installation at or near that Point of Connection Transpower shall not cease to provide such **metering installation** without giving at least 12 months' prior notice to the Customer. Metering Information derived from a **metering installation** provided:

- (a) by the Customer, is the property of the Customer;
- (b) by Transpower, is the property of Transpower; and
- (c) jointly by Transpower and the Customer, shall be owned jointly by Transpower and the Customer. The parties jointly grant to each party a licence to use (including reproduce and distribute) such jointly owned Metering Information for that party's own business purposes without any requirement to obtain the consent of the other party.

32.2 Certain Transpower Assets to be Made Available:

Transpower is to make available such of its **grid** located at or near a Point of Connection which are necessary to measure the flow of **electricity**, including secondary circuits of current and voltage transformers, for the purposes of the **metering installation** required under clause 32.1.

33. TECHNICAL COMPLIANCE OBLIGATION

33.1 Technical Compliance Obligations:

The obligations under clauses 28.2, 28.3, 29.1, 29.2, 30.1, 30.2, 32.1 and the Connection Code are Technical Compliance Obligations.

PART C: GRID CONNECTION

34. SCOPE OF GRID CONNECTION

This Part:

- (a) relates to the provision of the Connection Assets and sets out Transpower's obligations to provide the Connection Assets and make them available for the conveyance of **electricity** to or from each Point of Connection; and
- (b) relates to the provision of information by Transpower on connection and interconnection service performance.

35. DEFINITIONS

For the purposes of this Part C:

Capacity Service Levels

means the capacity service levels in Part A of Schedule 5 (Service Measures) for any or all **connection location(s)** (as the context may require);

Connection Assets

means the connection assets specified in Schedule 4 (Connection Assets);

Forecast Peak Loading

means in relation to a Customer Point of Service the maximum loading which Transpower considers is likely to arise at that Customer Point of Service as a result of the Customer's operations (whether for injection or off take of **electricity**) having regard to the combined effect of the rate of energy transfer between that Customer Point of Service and the Customer's Assets and the associated power factor, which is calculated by dividing the number of megawatts by the power factor specified in Schedule 2 (Points of Service) for that Customer Point of Service;

Interruption

means an **interruption** other than an **interruption** by reason of Transpower exercising its rights under this Agreement to disconnect or de-energise a Point of Connection because the Customer is in breach of its obligations;

Loss of Connection Minutes

means the aggregated duration in minutes of Interruptions during a specified period;

Normal Conditions

means, in relation to a Customer Point of Service, the following conditions as they relate to operation of the **grid**:

- (a) there are no **outages** having a material effect on the capability of the **grid** servicing the Customer Point of Service;

- (b) where the operation of particular **generating units** may have a material effect on the Customer Point of Service, sufficient of those **generating units** are available to be dispatched;
- (c) all Connected Parties whose operations may have a material effect on the Customer Point of Service are materially compliant with the requirements of the Connection Code and Part 8 of the Code; and
- (d) voltages on the grid having a material effect on the Customer Point of Service are within the range of levels required by Part 8 of the Code.

Planned Interruption

means an Interruption caused by a **planned outage**;

Target Voltage

means, in relation to a Customer Point of Service, the nominal voltage at the bus or such other voltage as may be agreed between Transpower and the Customer;

Unplanned Interruption

means an Interruption caused by an **unplanned outage**;

Unserviced Energy

means the estimated aggregate amount by which the demand for **electricity** exceeds the supply of **electricity** at each Customer Point of Service as a result of **planned outages** or **unplanned outages** of Connection Assets; and

Voltage Range Objective

means:

- (a) in relation to a Customer Point of Service at which all supply transformers have on-load tap changers installed, $\pm 2.5\%$ of the Target Voltage for that Customer Point of Service;
- (b) in relation to a Customer Point of Service at which any supply transformer has off-load tap changers installed, $\pm 5\%$ of the Target Voltage for that Customer Point of Service; and
- (c) in relation to any other Customer Point of Service, the voltage range specified in clause 8.22(1) of the Code for the nominal voltage existing at that Customer Point of Service.

36. SERVICE STANDARDS

36.1 Capacity Service Levels:

- (a) Except as permitted by clause 36.1(b), Transpower must:
 - (1) at all times make the Connection Assets available:
 - A. at the Capacity Service Levels;

- B. in the configuration set out in Schedule 4 (Connection Assets);
and
- (2) not change the Connection Assets.
- (b) Transpower is not required to comply with clause 36.1(a) if:
 - (1) permitted under the **Outage Protocol**;
 - (2) a Connection Asset has been replaced or enhanced as a result of an investment undertaken in accordance with clause 12.40 of the Code;
or
 - (3) a Connection Asset is permanently removed from service or the Connection Assets are permanently reconfigured in accordance with clause 40.3.
- (c) Notwithstanding clause 36.1(a)(1)(A) or any other provision of this Agreement, to the extent that an act, omission, event, or series of related events constitutes a breach of a Capacity Service Level and a breach of the **Outage Protocol**, Transpower's sole liability for that breach will be under the Code and Transpower will not be liable under this Agreement for that breach. To avoid doubt, clause 15.5 does not apply in such instance.

36.2 **Availability and Reliability Service Levels for Information:**

The service levels in Part A of Schedule 5 (Service Measures) which relate to availability and reliability at a Customer Point of Service are for the purpose of providing the Customer with information on those service levels only. Transpower will not be in breach of this Agreement for failing to meet those service levels.

36.3 **Reporting and Response Service Levels**

Transpower will comply with the reporting and response service levels in Part B of Schedule 5 (Service Measures).

37. **REPORTING**

37.1 **Performance Reporting on Connection Asset Services:**

Transpower will report to the Customer by 30 November each year on performance in respect of each **connection location** for the preceding period from 1 July to 30 June using the following indices of performance:

- (a) **Capacity of Connection Assets:**
 - (1) in respect of each Capacity Service Level, the number of- times the Capacity Service Level was not met, except where clause 36.1(b) applies; and
 - (2) in respect of each **branch** listed in Schedule 5 (Service Measures), the design maximum fault level in Amps per second.

(b) **Availability of Connection Assets:**

(1) **Unavailability due to Planned Outages:**

percentage of hours per year that the aggregate Connection Assets relating to a Customer Point of Service (including Connection Assets between the Customer Point of Service and any Point of Connection relating to the Customer Point of Service) are unavailable due to a **planned outage** of any of those Connection Assets of one minute or longer, compared to the service level for annual unavailability of the Connection Assets due to **planned outages** of any of those Connection Assets of one minute or longer set out in Part A of Schedule 5 (Service Measures);

(2) **Unavailability due to Unplanned Outages:**

percentage of hours per year that the aggregate Connection Assets relating to a Customer Point of Service (including Connection Assets between the Customer Point of Service and any Point of Connection relating to the Customer Point of Service) are unavailable due to an **unplanned outage** of any of those Connection Assets of one minute or longer, compared to the service level for annual unavailability of the Connection Assets due to **unplanned outages** of any of those Connection Assets of one minute or longer set out in of Part A of Schedule 5 (Service Measures);

(3) **Unavailability due to momentary Outages**

number of times per year that the aggregate Connection Assets relating to a Customer Point of Service (including Connection Assets between the Customer Point of Service and any Point of Connection relating to the Customer Point of Service) are unavailable due to **outages** of any of those Connection Assets that are shorter than one minute.

(c) **Reliability:**

(1) **Number of Interruptions:**

A. number of Planned Interruptions, at a Customer Point of Service of one minute or longer due to a **planned outage** of Connection Assets (including Connection Assets between a Customer Point of Service and any Point of Connection relating to the Customer Point of Service) of one minute or longer, compared to the service level for the annual number of Planned Interruptions at the Customer Point of Service due to **planned**

outages of the Connection Assets set out in Part A of Schedule 5 (Service Measures);

- B. number of Planned Interruptions at a Customer Point of Service of one minute or longer due to a **planned outage of interconnection assets** of one minute or longer, compared to the service level for the annual number of Planned Interruptions at the Customer Point of Service due to **planned outages of interconnection assets** set out in Part A of Schedule 5 (Service Measures);
- C. number of Unplanned Interruptions at a Customer Point of Service of one minute or longer due to an **unplanned outage of Connection Assets** (including Connection Assets between the Customer Point of Service and any Point of Connection relating to Customer Point of Service) of one minute or longer, compared to the service level for the annual number of Unplanned Interruptions at the Customer Point of Service due to **unplanned outages of Connection Assets** set out in Part A of Schedule 5 (Service Measures);
- D. number of Unplanned Interruptions at a Customer Point of Service of one minute or longer due to an **unplanned outage of interconnection assets** of one minute or longer, compared to the service level for the annual number of Unplanned Interruptions at the Customer Point of Service due to **unplanned outages of interconnection assets** set out in Part A of Schedule 5 (Service Measures);
- E. number of Interruptions at a Customer Point of Service shorter than one minute per year, due to **outages of Connection Assets** at a Customer Point of Service (including Connection Assets between the Customer Point of Service and any Point of Connection relating to Customer Point of Service) that are shorter than one minute; and
- F. number of Interruptions at a Customer Point of Service shorter than one minute per year, due to **outages of interconnection assets** that are shorter than one minute.

(2) **Duration of Interruptions:**

Loss of Connection Minutes due to:

- A. Planned Interruptions at a Customer Point of Service of one minute or longer caused by **planned outages of Connection**

Assets (including Connection Assets between the Customer Point of Service and any Point of Connection relating to the Customer Point of Service) of one minute or longer;

- B. Planned Interruptions at a Customer Point of Service of one minute or longer caused by **planned outages** of **interconnection assets** of one minute or longer;
- C. Unplanned Interruptions at a Customer Point of Service of one minute or longer caused by **unplanned outages** of Connection Assets (including Connection Assets between the Customer Point of Service and any Point of Connection relating to the Customer Point of Service) of one minute or longer; and
- D. Unplanned Interruptions at a Customer Point of Service of one minute or longer caused by **unplanned outages** of **interconnection assets** of one minute or longer.

(3) **Unservd Energy:**

Amount of Unserved Energy due to:

- A. Planned Interruptions of one minute or longer caused by a **planned outage** of Connection Assets at a Customer Point of Service (including Connection Assets between the Customer Point of Service and any Point of Connection relating to the Customer Point of Service) of one minute or longer, compared to the service level for Unserved Energy caused by Planned Interruptions at the Customer Point of Service of one minute or longer caused by **planned outages** of one minute or longer of Connection Assets set out in Part A of Schedule 5 (Service Measures); and
- B. Unplanned Interruptions at the Customer Point of Service of one minute or longer caused by an **unplanned outage** of Connection Assets (including Connection Assets between the Customer Point of Service and any Point of Connection relating to Customer Point of Service) of one minute or longer, compared to the service level for Unserved Energy caused by Unplanned Interruptions at the Customer Point of Service of one minute or longer caused by **unplanned outages** of one minute or longer of Connection Assets set out in Part A of Schedule 5 (Service Measures).
- C. Planned Interruptions of one minute or longer caused by a **planned outage** of **interconnection assets** at a Customer Point

of Service of one minute or longer, compared to the service level for Unserved Energy caused by Planned Interruptions at the Customer Point of Service of one minute or longer caused by **planned outages** of one minute or longer of **interconnection assets** set out in Part A of Schedule 5 (Service Measures); and

- D. Unplanned Interruptions at the Customer Point of Service of one minute or longer caused by an **unplanned outage** of **interconnection assets** of one minute or longer, compared to the service level for Unserved Energy caused by Unplanned Interruptions at the Customer Point of Service of one minute or longer caused by **unplanned outages** of one minute or longer of **interconnection assets** set out in Part A of Schedule 5 (Service Measures).

(d) **Customer Service Measures**

For each reporting and response service level set out in Part B of Schedule 5, the number of times the service level was not met.

As part of its report under this clause 37.1, Transpower will:

(e) **Identify Source of Failure:**

to the extent practicable, identify any circumstance which may have given rise to any failure to meet a service level; and

(f) **Advise Intended Remedial Steps:**

advise on any steps that it intends to take or other options to reduce the likelihood of failing to meet the service levels in the future.

37.2 **Real time signal of demand by Region from SCADA**

Transpower must provide to the Customer information on the **regional demand** (as defined in the **transmission pricing methodology**) for each region that the Customer has a **connection location**. This information is to be derived from **SCADA**, updated at least every five minutes, and updated not more than five minutes after the **regional demand** is measured.

37.3 **Information on capacities of individual Connection Assets**

(a) Transpower must publish:

- (1) for each transformer that is a Connection Asset, the overall 24 hour post contingency capacity rating of the Connection Asset in Amps and MVA, for both the summer and winter periods; and

- (2) for all other Connection Assets, the overall capacity rating of the Connection Asset in Amps and MVA and, if the Connection Assets are circuits, for both the summer and winter periods.
- (b) The information required under paragraph (a) above:
- (1) must be consistent with the **manufacturer's specification** of the Connection Asset or with the most recent Asset Capability Statement provided by Transpower under clause 2(f) of Technical Code A of Schedule 8.3 of the Code, if this differs from the **manufacturer's specification**;
 - (2) must be provided in a form that allows the **branch** to which each Connection Asset belongs to be easily identified; and
 - (3) must be published either in the Centralised Data Set maintained under clause 12.72 of the Code or in the form determined by the Authority in accordance with clause 12.89 of the Code for publication of the information required under clause 12.88 of the Code.

37.4 Performance Reporting on Interconnection Asset Services:

To the extent that the following information relates to the delivery of **electricity** to a Customer Point of Service or any Interruptions, and is required to be provided under the Code, Transpower will provide to the Customer, by 30 November each year:

- (a) the information set out in the annual report on **interconnection branch** capacity and **grid** configuration that Transpower is required to **publish** under Subpart 6 of Part 12 of the Code; and
- (b) the information set out in the annual report on the asset availability and reliability of **interconnection assets** under Subpart 6 of Part 12 of the Code that Transpower is required to **publish** under Subpart 6 of Part 12 of the Code.

37.5 De-energisation:

Transpower's obligations under this Part are subject to any obligations or rights it may have under this Agreement to de-energise a Point of Connection or to require a Point of Connection to be de-energised. In addition, Transpower may de-energise a Point of Connection if directed to do so by the Authority or the **Rulings Panel** under the Code or by the **clearing manager** or any other person authorised to do so by the Code and Transpower will use reasonable endeavours to notify the Customer in advance of such de-energisation if it has received sufficient notice of the direction.

37.6 Reporting on estimated reliability of feeder branches

- (a) If requested to do so by the Customer, Transpower must provide the Customer with an estimate of the expected annual number of Unplanned Interruptions of one minute or longer at a Point of Connection due to **unplanned outages** of Connection Assets of one minute or longer or such estimate being as accurate as is reasonably practicable.
- (b) The estimate under paragraph (a) must be provided within 40 Business Days of a request from the Customer unless:
 - A. it is not reasonably practicable for Transpower to do so, in which case Transpower must provide the information as soon as possible and must advise the Customer of the date by which the estimate will be provided; or
 - B. agreed otherwise between Transpower and the Customer.

38. COMPLIANCE WITH LAWS, RULES AND STANDARDS

The Customer will design, construct, maintain and operate the Customer's Assets, and Transpower will design, construct, maintain and operate the Connection Assets, in accordance with:

- (a) **Law**
all relevant Laws;
- (b) **Rules**
the requirements of the Code (including obligations on the Customer to provide information to facilitate system planning, as set out in clause 12.54 of the Code); and
- (c) **Good Electricity Industry Practice and standards**
Good Electricity Industry Practice.

39. POINTS OF SERVICE SCHEDULE

39.1 Points of Service Schedule:

Schedule 2 (Points of Service) is to:

- (a) **Identify Points of Service:**
identify the Customer Points of Service;
- (b) **Forecast Loading:**
contain a forecast loading table incorporating all of the information required under clause 39.2 for each Customer Point of Service; and

(c) **Voltage:**

contain a voltage table incorporating all of the information required under clause 39.3 for each Customer Point of Service at which **electricity** is conveyed from the **grid** to the Customer's Assets.

The information contained in the forecast loading table and the voltage table is for the Customer's information purposes only and may be amended by Transpower at any time to reflect changes to the **assets** installed at the Customer Points of Service. Transpower will notify the Customer of any amendments to the tables promptly after it amends the table. In any event, Schedule 2 (Points of Service) is to be reviewed and updated annually in accordance with clause 39.4.

39.2 **Forecast Loading Table:**

The forecast loading table in Schedule 2 (Points of Service) is to specify Transpower's reasonable view on the following information:

(a) **Forecast Peak Loading:**

the rate of energy transfer in megawatts and the associated power factor used to calculate the Forecast Peak Loading for that Customer Point of Service for a specified period;

(b) **Regional Grid Constraints:**

whether there are any regional grid constraints that could lead to the maximum rate of energy transfer, measured in megawatts, at which the Connection Assets are capable of simultaneously conveying **electricity** to or from all the Customer Points of Connection at one Customer Point of Service, from time to time being less than the number of megawatts recorded in the forecast loading table for that Customer Point of Service;

(c) **Firm Supply Transformers:**

whether the combined rating of the connection or supply transformers normally remaining in use at the Customer Point of Service during an **outage** of the largest transformer at that Customer Point of Service exceeds the Forecast Peak Loading for that Customer Point of Service; and

(d) **Spare Transformer To Be Kept On-site:**

where the information in response to (c) is negative, indicate whether or not the Customer and Transpower have agreed that Transpower is to keep on site at the relevant **connection location** a spare transformer which can be put into service within a reasonable period of time following an **outage** of one of the transformers normally in use so that the rating of the revised

transformer configuration at the Customer Point of Service following the replacement would exceed the Forecast Peak Loading.

39.3 Voltage Table:

The voltage table is to contain sufficient information to enable identification of the Voltage Range Objective for each Customer Point of Service at which **electricity** is conveyed from the **grid** to the Customer's Assets and may include the following:

(a) **Nominal Voltage:**

the nominal voltage at the bus;

(b) **Target Voltage:**

the Target Voltage;

(c) **On Load Tap Changers:**

a statement as to whether or not on-load tap changers are installed on all supply transformers at that Customer Point of Service; and

(d) **Tap Changer Range and Step:**

the tap range and tap step of any tap changers installed on any supply transformers at that Customer Point of Service.

The voltage table must also identify whether or not Transpower considers the Voltage Range Objective is achievable under Normal Conditions with existing equipment, and if not, provide a summary of the reasons for Transpower's opinion.

39.4 Initial and Annual Update of Points of Service Schedule:

To facilitate discussion of likely future usage at the Customer Points of Service, Transpower will:

(a) within 20 Business Days of the Commencement Date, provide the Customer with a proposed Points of Service Schedule for the period up to 31 March in the following year. The proposed Points of Service Schedule will become Schedule 2 (Points of Service) unless within 50 Business Days after the Commencement Date any revised proposed Points of Service Schedule has been notified to the Customer in which case the revised proposed Points of Service Schedule will become Schedule 2 (Points of Service) as from that date;

(b) prior to 31 December in each year, review and update the information in Schedule 2 (Points of Service) and provide the Customer with a proposed

Points of Service Schedule for the 12 month period commencing on 1 April in the following year. The proposed Points of Service Schedule will become Schedule 2 (Points of Service) as from 1 April in the following year unless prior to then any revised proposed Points of Service Schedule has been notified to the Customer in which case the revised proposed Points of Service Schedule will become Schedule 2 (Points of Service) as from 1 April in the following year.

39.5 Customer to Advise Future Loading:

The Customer is to keep Transpower informed of what it reasonably expects will be the maximum loading likely to arise at each Customer Point of Service as a result of the Customer's operations on a one to five year basis. The Customer is to provide such information to Transpower within 10 Business Days of receipt of a proposed Points of Service Schedule and otherwise as Transpower may reasonably request.

39.6 Meeting to Discuss Future Usage:

Either party may call a meeting with the other party to discuss any of:

(a) **Proposed Points of Service Schedule:**

a proposed Points of Service Schedule;

(b) **Customer's Expectations:**

the Customer's expectations of future maximum loading at each Customer Point of Service as a result of the Customer's operations over the next five years; and

(c) **Future Service Capability:**

the options for making Connection Assets available in future years at each Customer Point of Service to meet the Customer's reasonable expectations of future maximum loading at each Customer Point of Service as a result of the Customer's operations.

40. CHANGING AND REMOVING CONNECTION ASSETS

40.1 Inconsistency with Grid Reliability Standards:

Where:

- (a) a **grid reliability report published** by Transpower in accordance with clause 12.76 of the Code sets out that the power system is not reasonably expected to meet the **N-1 criterion** at all times over the next five years; and
- (b) a Connection Asset is the cause of this,

then, unless Transpower and the Customer have already complied with clauses 12.35 to 12.37 of the Code in respect of that departure from the **grid reliability standards**, Transpower must promptly notify the Customer, and:

- (c) in the case of a Connection Asset at a **connection location** to which the Customer is the only **designated transmission customer** connected, or is the only **designated transmission customer** with a **transmission agreement** with Transpower requiring Transpower to make the Connection Asset available, follow the process set out in clause 40.2; and
- (d) in the case of a Connection Asset to which more than one **designated transmission customer** is connected, and the **transmission agreement** or **transmission agreements** between Transpower and the other **designated transmission customer(s)** require Transpower to make the Connection Assets available, follow the process set out in clause 12.40 of the Code.

40.2 Replacement and enhancement of Connection Assets

- (a) Where Transpower has identified a Connection Asset to which clause 40.1(c) applies:
 - (1) the Customer may propose the use of a different value of Unserved Energy, for the purposes of applying the **grid reliability standards** under this clause from the **value of expected unserved energy** in clause 4 of Schedule 12.2 of the Code, to Transpower within 15 Business Days of receiving notice under clause 40.1;
 - (2) if Transpower considers that the value of Unserved Energy proposed under subparagraph (1) is not reasonable, either it or the Customer may ask the Authority to provisionally approve that value under clause 12.39 of the Code. If the Authority does not provisionally approve the different value of Unserved Energy, the **value of expected unserved energy** in clause 4 of Schedule 12.2 of the Code applies; and
 - (3) if Transpower considers that the proposed value of Unserved Energy is reasonable, or the Authority provisionally approves the different value under clause 12.39 of the Code, that different value must be used in applying the **grid reliability standards** under paragraphs (b) to (d) below;
- (b) Transpower must as soon as practicable after identifying a Connection Asset to which clause 40.1(c) applies, investigate whether the Connection Asset meets the **grid reliability standards** (modified to take into account any different value of Unserved Energy that applies under paragraph (a)).
- (c) If Transpower finds that the Connection Asset does not meet the **grid reliability standards** (modified to take into account any different value of Unserved Energy that applies under paragraph (a)), it must develop

proposals for investment in the **grid** to ensure that the Connection Asset meets the **grid reliability standards** (modified to take into account any different value of Unserved Energy that applies under paragraph (a)), and propose them to the Customer as soon as reasonably possible after the publication of the **grid reliability report**.

- (d) Transpower and the Customer must then attempt in good faith to reach an agreement, within six months of the date on which Transpower makes its proposals to the Customer under paragraph (c) or such longer period as agreed between the parties, for an investment or other solution (whether undertaken by Transpower or, subject to necessary land access being negotiated with Transpower, by the Customer or a third party in accordance with Good Electricity Industry Practice) that will have the effect of:
- (1) maintaining the level of reliability for the relevant **connection location** at the level of reliability in the **grid reliability standards** (modified to take into account any different value of Unserved Energy that applies under paragraph (a)); or
 - (2) increasing or decreasing the level of reliability for the relevant **connection location** above or below the **grid reliability standards** (modified to take into account any different value of Unserved Energy that applies under paragraph (a)), subject to Transpower and the Customer complying with clauses 12.35 to 12.37 of the Code.
- (e) If a different value of Unserved Energy from the **value of expected unserved energy** in clause 4 of Schedule 12.2 of the Code has been used under paragraphs (b) to (d) above, before giving effect to any agreement reached under paragraph (d) and regardless of whether or not the Authority has provisionally approved the different value of Unserved Energy, either Transpower or the Customer must comply with clause 12.39 of the Code.
- (f) If Transpower and the Customer have not been able to reach an agreement under paragraph (d) above within six months of the publication of the **grid reliability report**, or such longer period as agreed:
- (1) unless sub-paragraph (2) applies, the Customer or a third party shall be entitled to carry out an investment in respect of the Connection Assets, subject to necessary land access being negotiated with Transpower, Good Electricity Industry Practice and, if applicable, compliance with clauses 12.35 to 12.37 of the Code; or
 - (2) Transpower may ask the Commerce Commission to request that Transpower submit an investment proposal in respect of the Connection Assets and, if the investment proposal is approved, carry out the investment set out in the investment proposal. For the avoidance of doubt, if the investment proposal is not approved, the

Customer or a third party may carry out an investment under subparagraph (1) above.

40.3 **Reconfiguration and Permanent Removal of Connection Assets**

- (a) Transpower may only permanently remove a Connection Asset from service or permanently change the configuration of the Connection Assets from that set out in Schedule 4 (Connection Assets):
- (1) in the case of a Connection Asset or Connection Assets to which the Customer is the only **designated transmission customer** connected, or is the only **designated transmission customer** with a **transmission agreement** with Transpower requiring Transpower to make the Connection Asset or Connection Assets available, if the Customer agrees to such removal or reconfiguration, subject to Transpower and the Customer complying with clauses 12.35 to 12.37 of the Code; or
 - (2) in the case of a Connection Asset or Connection Assets to which more than one **designated transmission customer** is connected, and the **transmission agreement** or **transmission agreements** between Transpower and the other **designated transmission customer(s)** require Transpower to make the Connection Asset or Connection Assets available, in accordance with clauses 12.41 or 12.42 of the Code.
- (b) The Customer may not unreasonably decline to agree to the removal of a Connection Asset or the reconfiguration of the Connection Assets under clause 40.3(a)(2), taking into account the net benefits to other **designated transmission customers** and to end-users of **electricity** that might arise from the removal or reconfiguration.

40.4 **Changes to Connection Assets:**

If a Connection Asset is reconfigured, replaced, enhanced, or withdrawn from service on a permanent basis in accordance with clause 12.40 of the Code, then the process in clause 12.12 of the Code applies.

41. **GRID CHARGES**

41.1 **Customer's obligation to pay:**

The Customer must pay Grid Charges for each month calculated in accordance with the **transmission pricing methodology** and this Agreement.

41.2 **Setting Grid Charges:**

Within 20 Business Days of the Commencement Date, Transpower will:

- (a) **Grid Charges:**

calculate the rates of Grid Charges in accordance with the **transmission pricing methodology** payable by the Customer per month for each **connection location**; and

(b) **Grid Charges Schedule:**

enter such rates in a copy of Schedule 3 (Grid Charges) and forward it to the Customer.

(c) **Charges Effective From Commencement Date:**

For the avoidance of doubt, the Grid Charges are effective from the Commencement Date.

41.3 **Changes to Transmission Pricing Methodology:**

If there is any change to the **transmission pricing methodology** which affects the Grid Charges and it is not possible for Transpower to give notice of the recalculated Grid Charges under clause 41.5 before the change comes into effect, Transpower will as soon as practicable and in any event before the change comes into effect:

(a) **Recalculate Grid Charges:**

recalculate the Grid Charges in accordance with the revised **transmission pricing methodology** payable by the Customer per month; and

(b) **Amend Grid Charges Schedule:**

forward to the Customer a revised Schedule 3 (Grid Charges).

41.4 **Suspension of Grid Charges:**

- (a) If, for any reason, there is a continuous Interruption affecting all Points of Connection within the same **connection location** and lasting 24 hours or longer, the Grid Charges for any month during which the Interruption occurs will be calculated in accordance with the following formula:

$$a\left(1 - \frac{b}{c}\right)$$

where

a = the Grid Charges which would have been payable in respect of that **connection location** for that month if this clause did not apply;

b = the number of complete hours in the month during which the Interruption continued; and

c = the total number of hours in the month.

- (b) To avoid doubt, this clause 41.4 applies regardless of the cause of the Interruption, including if it was caused by Force Majeure.

41.5 Variation to Grid Charges:

- (a) Without limiting clause 41.3, Transpower may vary the Grid Charges payable per month as permitted under the **transmission pricing methodology** (provided such varied Grid Charges comply with the **transmission pricing methodology**). Transpower will give the Customer not less than three months' notice of any variation that is to be effective at the start of each **pricing year** as permitted under the **transmission pricing methodology**. For all other variations to the Grid Charges permitted under the **transmission pricing methodology**, Transpower will give the Customer not less than 20 Business Days' notice of the variation. If Transpower varies the Grid Charges, Transpower is to forward to the Customer a revised Schedule 3 (Grid Charges). Transpower's rights under this clause are in addition to any recalculation of Grid Charges under clause 19.2(b).
- (b) In addition to clause 41.5(a), if Transpower proposes to vary the Grid Charges, effective from the start of a **pricing year**, it will consult with the Customer, to the extent possible, before giving notice under clause 41.5(a). For the avoidance of doubt, Transpower is not prevented from giving notice under clause 41.5(a) by reason of failing to consult the Customer under this clause 41.5(b).

41.6 Alteration of Charges Resulting from Removal of Connection Assets:

If Transpower permanently removes any Connection Asset under clause 40.3, then:

(a) **Transpower will recalculate:**

Transpower will recalculate the Customer's **connection charges** to take account of such removal;

(b) **Schedule of Changes:**

Transpower will forward to the Customer a revised Schedule 3 (Grid Charges) not less than 20 Business Days prior to the removal (or as much advance notice as reasonably practicable in the circumstances); and

(c) **Charges will Change:**

Transpower will notify the Customer of completion of the removal within 5 Business Days of such completion. In the absence of any agreement to the contrary the revised Schedule 3 (Grid Charges) will take effect on the first day following such completion. Transpower's rights under this

clause 41.6 are in addition to its rights to vary the Grid Charges under clauses 41.3 and 41.5.

42. TECHNICAL COMPLIANCE OBLIGATIONS

42.1 Technical Compliance Obligations:

The obligations of Transpower and the Customer under clause 38 are Technical Compliance Obligations.

PART D: SETTLEMENT RESIDUE PAYMENTS

43. Administration fee

- (1) Transpower may charge the Customer an administration fee to cover the actual and reasonable costs of developing, implementing, and administering the methodology for allocating **settlement residue** and processing **settlement residue** payments.
- (2) The amount charged will not exceed a proportionate contribution to the costs referred to in subclause (1) measured against the amount of **settlement residue** paid to the Customer.
- (3) The amount may be deducted from any amount of **settlement residue** payable by Transpower to the Customer, or invoiced to the Customer as a Charge.

44. RECOVERY OF NEGATIVE SETTLEMENT RESIDUE

Where Transpower receives an invoice from the **clearing manager** for **settlement residue** (that is, there is negative **settlement residue** for a month) (Repayment Amount), Transpower may charge the Customer a contribution to the Repayment Amount calculated by applying Transpower's **settlement residue** allocation methodology to the Repayment Amount as if it were positive **settlement residue**.

SCHEDULE 1
POINTS OF CONNECTION

Connection location	Points of Service	Points of Connection
----------------------------	--------------------------	-----------------------------

SCHEDULE 2
POINTS OF SERVICE

(As described in clause 39)

Forecast Loading Table

Customer Point of Service	Forecast Peak Loading		Injection/ Offtake	Subject to regional grid constraints? (Yes/No)	Supply Transformer		Comments
	MW	Pf			Firm with no break? (Yes/No)	Firm after change of on-site spare? (Yes/No)	

Voltage Table

Customer Point of Service	Nominal Bus Voltage	Target Voltage	Tap Changer Type	Tap Range %	Tap Step %	Can voltage range objectives be met? (Yes/No)	Comments

SCHEDULE 3
GRID CHARGES

SCHEDULE 4
CONNECTION ASSETS

Example diagram of the configuration of connection assets at a **connection location**:

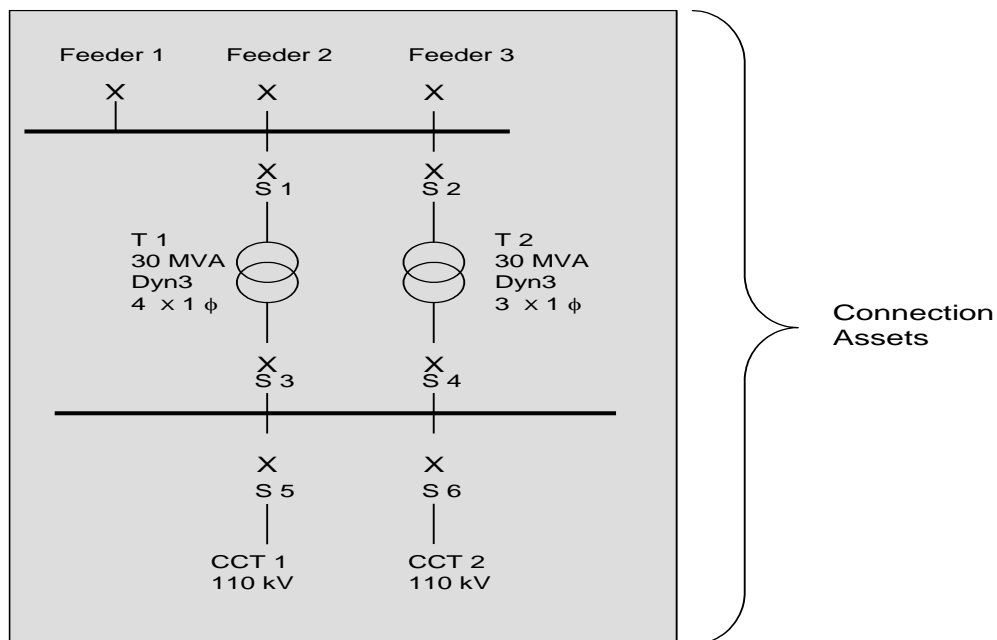

**SCHEDULE 5
SERVICE MEASURES**

Part A: Connection location-specific service measures

1. Connection location: [name]

1.1 Service: Capacity of Connection Branches

1.1.1 Circuit Branch: [Identify Circuit Branch]

Service measure	Service level
Overall continuous capacity rating of the circuit branch	[] Amps and [] MVA [<i>for summer period</i>] and [] Amps and [] MVA [<i>for winter period</i>]
Level of impedance of the circuit branch resistive and reactive – shunt [<i>Provide for each circuit branch with impedance of 0.0001 PU or more using 100MVA as the base</i>]	[] PU (using 100MVA as the base)
Level of impedance of the circuit branch resistive and reactive – series [<i>Provide for each circuit branch with impedance of 0.0001 PU or more using 100MVA as the base</i>]	[] PU (using 100MVA as the base)
Nominal high voltage rating of the Circuit	[] kV
High voltage range that the circuit branch can operate over	Maximum: [] kV Minimum: [] kV

[Repeat table for each **circuit branch** at the **connection location**]

1.1.2 Transformer Branch: [Identify Transformer Branch]

Service measure	Service level
Overall 24 hour post contingency capacity rating of the transformer branch	2 Winding [] Amps and [] MVA [<i>for summer period</i>] and [] Amps and [] MVA [<i>for winter period</i>] 3 Winding

Service measure	Service level
	<p>HV [] Amps and [] MVA [<i>for summer period</i>] and [] Amps and [] MVA [<i>for winter period</i>]</p> <p>MV [] Amps and [] MVA [<i>for summer period</i>] and [] Amps and [] MVA [<i>for winter period</i>]</p> <p>LV [] Amps and [] MVA [<i>for summer period</i>] and [] Amps and [] MVA [<i>for winter period</i>]</p>
Continuous capacity rating	<p>2 Winding [] Amps and [] MVA</p> <p>3 Winding</p> <p>HV [] Amps and [] MVA</p> <p>MV [] Amps and [] MVA</p> <p>LV [] Amps and [] MVA</p>
Level of impedance of the transformer branch resistive and reactive – shunt [<i>Provide for each transformer branch</i>]	<p>2 Winding [] PU (using 100MVA as the base)</p> <p>3 Winding HV[] PU, MV []PU, LV [] PU (using 100MVA as the base)</p>
Level of impedance of the transformer branch resistive and reactive – series [<i>Provide for each transformer branch</i>]	<p>2 Winding [] PU (using 100MVA as the base)</p> <p>3 Winding HV[] PU, MV []PU, LV [] PU (using 100MVA as the base)</p>
Nominal high voltage rating of the transformer branch	[] kV
High voltage range that the transformer branch can operate over	Maximum: [] kV Minimum: [] kV
Tapping steps and ranges	<p>Tap voltage range:</p> <p>Maximum: [] kV Minimum: [] kV</p> <p>Number of tapping steps: []</p>

Service measure	Service level
	<p>Size of each tapping step as a percentage of nominal operating voltage range: []%</p> <p>On-load/Off-load: [<i>On-load/Off-load</i>]</p> <p>On-load tapping capability [<i>Automatic/Manual</i>]</p> <p>[If on-load tapping capability is automatic, is it auto selected? [<i>Yes/No</i>]]</p> <p>[or]</p> <p>[If on-load tapping capability is manual, what tap step is normally set? [<i>Actual or expected position at winter peak demand</i>]]</p> <p>[Repeat for each tap changer on the Transformer branch]</p>

[Repeat table for each **transformer branch** at the **connection location**]

1.2 **Service: Availability at Customer Point of Service: [*name*]**

Service measure	Service level
Annual unavailability of aggregate Connection Assets relating to the Customer Point of Service due to planned outages of any of those Connection Assets of one minute or longer	Unavailable for no more than []% of 1 July to 30 June year (pro rata for a part year), calculated by hours unavailable ÷ hours per year
Annual unavailability of aggregate Connection Assets relating to the Customer Point of Service due to unplanned outages of any of those Connection Assets of one minute or longer	Unavailable for no more than []% of per 1 July to 30 June year (pro rata for a part year), calculated by hours unavailable ÷ per year

[Repeat table for each **Customer Point of Service** at the **connection location**]

1.3 Service: Reliability at Customer Point of Service: *[name]*

Service measure	Service level
Annual number of Planned Interruptions at the Customer Point of Service of one minute or longer due to planned outages of Connection Assets (including Connection Assets between the Customer Point of Service and any Point of Connection relating to the Customer Point of Service) of one minute or longer	<i>[number]</i> per 1 July to 30 June year (pro rata for a part year)
Annual number of Planned Interruptions at the Customer Point of Service of one minute or longer due to planned outages of interconnection assets of one minute or longer	<i>[number]</i> per 1 July to 30 June year (pro rata for a part year)
Annual number of Unplanned Interruptions at the Customer Point of Service of one minute or longer due to unplanned outages of Connection Assets (including Connection Assets between the Customer Point of Service and any Point of Connection relating to the Customer Point of Service) of one minute or longer	<i>[number]</i> per 1 July to 30 June year (pro rata for a part year)
Annual number of Unplanned Interruptions at the Customer Point of Service of one minute or longer due to unplanned outages of interconnection assets of one minute or longer	<i>[number]</i> per 1 July to 30 June year (pro rata for a part year)
Unserviced Energy resulting from Planned Interruptions at the Customer Point of Service of one minute or longer caused by planned outages of one minute or	[] MWh

Service measure	Service level
longer of Connection Assets (including Connection Assets between the Customer Point of Service and any Customer Point of Connection relating to the Customer Point of Service).	
Unserviced Energy resulting from Planned Interruptions at the Customer Point of Service of one minute or longer caused by planned outages of one minute or longer of interconnection assets	[] MWh
Unserviced Energy resulting from Unplanned Interruptions at the Customer Point of Service of one minute or longer caused by unplanned outages of one minute or longer of Connection Assets (including Connection Assets between the Customer Point of Service and any Point of Connection relating to the Customer Point of Service).	[] MWh
Unserviced Energy resulting from Unplanned Interruptions at the Customer Point of Service of one minute or longer caused by unplanned outages of one minute or longer of interconnection assets	[] MWh

*[Repeat table for each Customer Point of Service at a **connection location**]*

2. Connection Location: [name]

*[Repeat above measures for each **connection location**]*

Part B: Reporting and response service measures

Service measure	Service level
Length of time taken by Transpower to report a breach of service levels	21 days, or such other time period as agreed between the parties.
Length of time taken by Transpower to investigate and respond to Complaints about service provided under this Agreement	21 days, or such other time period as agreed between the parties.
Length of time taken by Transpower to provide a report following an unplanned interruption to, or degradation of, its transmission service	42 days, or such other time period as agreed between the parties.

SCHEDULE 6
ACCESS AND OCCUPATION SCHEDULE

1. SCOPE OF ACCESS AND OCCUPATION SCHEDULE

1.1 Acknowledgement:

Transpower and the Customer acknowledge:

(a) Land:

Transpower is the owner of the Land;

(b) Facilities:

the Customer is the owner or lessee of the Facilities;

(c) Licence:

Transpower has agreed to grant to the Customer a licence to occupy certain parts of the Land in order to maintain and operate the Facilities for the conveyance of **electricity**; and

(d) Compliance:

the licence specified in this Schedule is granted subject to the Customer complying with the Customer's obligations under this Schedule.

2. GLOSSARY AND INTERPRETATION

2.1 Definitions:

In this Schedule, unless the context otherwise requires:

Authority

means any local or territorial authority, or any other body having jurisdiction over the Land and the Facilities or their use;

Equipment

includes equipment, tools, cables, machinery, lines, wires and all materials and items required for the purposes of exercising any of the rights given in this Schedule;

Facilities

means, in relation to each piece of Land, the Equipment and any structures related to that Equipment owned or leased by the Customer and located in any Facilities Area and described in appendix 1, including any further Equipment or structures constructed by the Customer in accordance with clause 7, and any **metering installation** required under clause 32 of Part B of this Agreement;

Facilities Area

means, in relation to each piece of Land, the area occupied by the Facilities and more particularly as marked in the relevant plan attached to and forming part of appendix 1;

Land

means each piece of land described in appendix 1;

Maintain

includes maintain, repair, replace, renew, alter, inspect, remove, lay and **Maintenance** is to be interpreted accordingly;

Operate

means the conveyance of **electricity** by means of the Facilities, and includes the conveyance of any other signal or matter which is permitted or authorised in accordance with this Schedule and **Operation** is to be interpreted accordingly; and

Operating Standards

means the operating standards set out in the Connection Code.

2.2 Appendices:

References to appendices are references to appendices of this Schedule.

2.3 Separate Licence:

This Schedule is to be read as a separate licence for the Facilities located on each piece of Land.

3. LICENCE

3.1 Rights of Licensee:

- (a) Transpower grants the Customer:
 - (1) a licence for the Facilities to occupy the Facilities Area;
 - (2) the right to Operate and Maintain the Facilities for the purpose of the conveyance of **electricity**; and
 - (3) the right of ingress and egress over the Land for the purposes of (2) above,upon the terms and conditions of this Schedule.
- (b) Transpower will ensure that the Customer has unimpeded access to the Facilities at all reasonable times.

3.2 Licence Charges:

The Customer must pay all of the Licence Charges for each month specified in appendix 1 in accordance with this Agreement.

4. USE OF FACILITIES AREA

4.1 Purpose of Occupation:

The Customer will use the Facilities Area for the purpose of Maintaining and Operating the Facilities as set out in this Schedule and not for any other purpose.

4.2 No Warranty as to Suitability:

Transpower does not in any way warrant or represent that the Facilities Area or the Land will be suitable or adequate for the purpose of the Customer and, to the full extent permitted by law, all warranties and representations as to suitability and adequacy imposed by law are expressly negated.

4.3 Not fixtures:

The Facilities will not become, or be deemed to be, fixtures or part of the Land. The Facilities will remain at all times in the legal and beneficial ownership of the Customer (or the lessor of those Facilities to the Customer as the case may be).

4.4 Disclosure of ownership:

Transpower, when dealing with third parties, will disclose to such third parties the nature of the Customer's ownership interest in the Facilities where not to do so would or might give rise to the impression that a person other than the Customer was the owner of the Facilities.

5. COMPLIANCE WITH SAFETY AND SECURITY PROCEDURES

5.1 Compliance with Operating Standards:

The Customer, when exercising any of the rights contained in this Schedule, must at all times comply with the Operating Standards relating to safety, security, access and operating practice.

5.2 Suspension of Rights:

Notwithstanding anything to the contrary in this Agreement, Transpower reserves the right to suspend the exercise of the Customer's rights under this Schedule if the Customer's activities on the Land, including Maintenance and Operation, are not carried out in accordance with the Operating Standards. Transpower agrees

that in exercising its powers under this clause 5.2, it will only do so on reasonable grounds relating to the safety, integrity and continuity of the operation of Transpower's substation or any other part of the **grid** and any suspension will be for the minimum period reasonably necessary to ensure the Customer's compliance with the Operating Standards.

5.3 Security:

Transpower will use reasonable endeavours to maintain the security of any perimeter fences erected on the Land but otherwise Transpower will not be responsible for the security of the Facilities, property and other structures or improvements erected by the Customer in the Facilities Area.

5.4 Emergencies:

The Customer may, from time to time, if it considers (acting reasonably) that there is an emergency situation involving public safety and security, temporarily exclude entry to the Facilities Area.

6. OPERATION AND MAINTENANCE OF FACILITIES

6.1 Right to Maintain and Operate Facilities:

Transpower will allow the Customer and its Associates to enter onto the Land with or without Equipment or vehicles for any purposes associated with the Maintenance and Operation of the Facilities.

6.2 Operation:

The Customer must Operate the Facilities in accordance with Good Electricity Industry Practice.

6.3 Maintenance:

The Customer must:

(a) **Maintain:**

Maintain the Facilities in good order and repair in accordance with Good Electricity Industry Practice;

(b) **Repair:**

within a reasonable time, comply with any notice given by Transpower to repair the Facilities and carry out all other repairs, in each case, to the satisfaction of Transpower (acting reasonably); and

(c) **Repair of Damage:**

if, during the Maintenance or the Operation of the Facilities, any damage is caused to the Facilities Area by the Customer and its Associates, the Customer will reinstate the area and make good any damage.

7. IMPROVEMENTS AND NEW FACILITIES

7.1 New Structures and Equipment:

- (a) Subject to the Customer's right to Maintain the Facilities, the Customer must not construct any new structures or Equipment (including upgrading or improving existing Equipment) in the Facilities Area without Transpower's prior written approval (not to be unreasonably withheld or delayed).
- (b) The Customer must not construct any new structures or Equipment on the Land outside the Facilities Area without Transpower's prior written approval in its sole discretion.

7.2 Plans and Specifications:

In seeking Transpower's approval for the construction of any new structures and any new Equipment in the Facilities Area or on the Land, the Customer will submit plans and specifications of the proposed works to Transpower for approval and Transpower will respond with its approval within 20 Business Days or such other time as is reasonable in the circumstances. Transpower may require as conditions of its approval that:

(a) **Executed by Contractors:**

any such works must be executed by contractors or tradesmen approved by Transpower (acting reasonably); and

(b) **Consents etc:**

the Customer obtains from every Authority all necessary consents, approvals and permits and upon request produces copies of all such consents, approvals and permits to Transpower; and

(c) **Reimbursement:**

the Customer reimburses Transpower for any reasonable costs or expenses that may be incurred by Transpower in giving its approval for the construction of any new Equipment pursuant to this clause 7.2; and

(d) **Completion:**

upon completion of the works, the Customer produces any certificates of compliance issued by any Authority.

7.3 Updating Description of Facilities:

If the Customer constructs any new structures or any new Equipment pursuant to this clause 7:

(a) Customer to provide plans:

the Customer will, within 30 Business Days from the date of completion of such works, provide Transpower with an as-built plan of the completed works (in a form which is reasonably acceptable to Transpower (acting reasonably)); and

(b) Transpower to update Schedule:

Transpower will, within 10 Business Days from the date of receipt of such plan, update the descriptions of the Facilities and Facilities Area contained in appendix 1 and forward an amended appendix 1 to the Customer. The amended appendix 1 will form part of this Schedule from that date.

7.4 Building Act Compliance:

The Customer, when undertaking any building work (as that term is defined in the Building Act 2004), must comply with all statutory requirements including the obtaining of building consents and code compliance certificates under that Act (if required).

7.5 Repair of Damage:

Any damage to the Facilities Area caused during the construction of any new structures or any new Equipment will be made good by the Customer as soon as reasonably practicable.

8. NATURE OF OCCUPATION

8.1 No Legal or Equitable Interest:

The Customer acknowledges that this Schedule does not confer upon the Customer any legal or equitable interest in the Land.

8.2 No Caveat Registered:

The Customer must not lodge a caveat or any other such document against the title to the Land.

9. RISK AND INDEMNITY

9.1 The Customer to Occupy Land at its Risk:

The Customer acknowledges and agrees:

(a) **Transpower's Operations:**

that Transpower operates an electrical substation on the Land, with electrical plant and equipment located on it and that certain dangers exist; and

(b) **Release:**

to occupy and use the Land and Facilities Area at the Customer's risk and releases, to the fullest extent permitted by law, Transpower and its Associates from all claims and demands of any kind and from all liability which may arise in connection with the operation of the electrical substation relating to any accident, damage or injury occurring to any person or property on or about the Land or the Facilities Area that is caused directly or indirectly by the Customer or its Associates, except if the claims, demands or liability arise as a result of Transpower's negligence or failure to comply with the terms of this Schedule.

9.2 Indemnity:

The Customer indemnifies Transpower, to the fullest extent permitted by law, against all obligations (including strict liability), actions, proceedings, costs, claims, penalties, damages, charges, demands or loss suffered or incurred by Transpower:

(a) **Omissions:**

as a result of any act or omission by the Customer or its Associates; and

(b) **Breach of Statute:**

in relation to any action or proceeding taken against Transpower as a result of a breach of:

- (1) the Health and Safety at Work Act 2015;
- (2) the Electricity Act 1992;
- (3) the Building Act 2004;
- (4) the Resource Management Act 1991; or
- (5) any other Law,

directly or indirectly affecting, or relating to, the use of the Land, the Facilities Area or the Facilities by the Customer or its Associates (other than as a result of any negligence by Transpower or default by Transpower under this Agreement), or any activity carried on by the Customer or its Associates on or in relation to the Land, the Facilities Area or the Facilities.

Transpower must use all reasonable endeavours to mitigate any obligations, actions, proceedings, costs, claims, penalties, damages, charges, demands or loss suffered or incurred by it as a result of any of those matters set out in paragraphs (a) and (b) above and this indemnity shall be limited accordingly.

To avoid doubt, the Customer's liability under this clause 9.2 is subject to the limitations on liability set out in clause 20.7 of Part A of this Agreement.

9.3 Other Rights:

Transpower's rights under clause 9.2 are in addition to any other rights Transpower may have under this Agreement.

10. INSURANCE

10.1 Public Risk:

The Customer must keep current at all times during the term of this Agreement (without in any way limiting the liability of the Customer under clauses 9.1 and 9.2), a policy of public risk insurance applicable to the Land and the Facilities for such amount as Transpower may from time to time reasonably require (being the amount which may be paid out arising out of any one single accident or event).

11. SIGNAGE

11.1 Approved Signage Only:

The Customer must not, without the prior consent of Transpower (such consent not to be unreasonably withheld), paint or exhibit any sign or notice on or about the Land or Facilities Area.

11.2 Safety Signs:

The Customer may, and if requested by Transpower, the Customer will affix signs or notices to warn the public of any danger in or about the Land or Facilities Area (such signs to be approved by Transpower (acting reasonably)).

**ACCESS AND OCCUPATION SCHEDULE
APPENDIX 1**

Connection location	Land	Facilities	Location	Monthly Licence Charge (excl GST)
--------------------------------	-------------	-------------------	-----------------	--

SCHEDULE 7 CREDIT SUPPORT

1. Credit Rating:

Where and for so long as the Customer has:

- (a) a long term credit rating of at least BB (Standard & Poors), Ba2 (Moody's Investor Service Inc) or BB (Fitch IBCA), or an equivalent rating from any other reputable rating agency which is acceptable to Transpower acting reasonably, and which rating is not on negative credit watch where either:
 - (1) the rating is at the minimum referred to above; or
 - (2) the rating agency has indicated it is considering assigning a rating below the minimum referred to above; or
- (b) an acceptable credit rating as determined by Transpower acting reasonably, or by an expert, in accordance with appendix 1 of this Schedule (Credit Policy),

(an "Acceptable Credit Rating"), the Customer will not be required to provide credit support under clause 2.

2. Credit Support:

If at any time the Customer does not have an Acceptable Credit Rating then within 20 Business Days of a request by Transpower (which request will include confirmation of the amount of Transpower's Counterparty Exposure), the Customer must provide, or (subject to clause 3) procure a third party to provide, to Transpower credit support in a form permitted by clause 4 for an amount not less than Transpower's Counterparty Exposure.

3. Credit Support Provider:

Transpower is only obliged to accept credit support from a third party where the third party provider has an Acceptable Credit Rating.

4. Types of Credit Support:

Where credit support must be provided under this Schedule, the types of credit support which may be provided are:

- (a) a bank guarantee that is in form and substance acceptable to Transpower acting reasonably, where a bank guarantee in the form of appendix 2 of this Schedule (Guarantee) will be acceptable to Transpower;

- (b) a letter of credit that is in form and substance acceptable to Transpower acting reasonably, where a letter of credit in the form of appendix 3 of this Schedule (Letter of Credit) will be acceptable to Transpower;
- (c) a third party guarantee that is in form and substance acceptable to Transpower acting reasonably, where a third party guarantee in the form of appendix 4 of this Schedule (Deed of Guarantee and Indemnity) will be acceptable to Transpower;
- (d) a surety bond that is in form and substance acceptable to Transpower, where a bond in the form of appendix 5 of this Schedule will be acceptable to Transpower;
- (e) a charge or security interest (as that term is defined in section 17 of the Personal Property Securities Act 1999) over assets acceptable to Transpower acting reasonably;
- (f) a cash bond;
- (g) any similar form of credit support acceptable to Transpower acting reasonably; or
- (h) any combination of the above.

The Customer will determine which of the above type or types of credit support is to be provided.

5. Changes to Level of Credit Support:

If, at any time, Transpower becomes aware that credit support provided by the Customer:

- (a) has become insufficient to cover; or
- (b) exceeds,

Transpower's Counterparty Exposure Transpower will promptly notify the Customer of the occurrence in clause 5(a) or (b) and:

- (c) in the case of clause 5(a), Transpower may require the Customer to provide additional credit support under clause 2; and
- (d) in the case of clause 5(b), the Customer may require Transpower to release the excess credit support, in which event the parties will take all steps necessary to effect such reduction in the level of credit support within 20 Business Days of the Customer giving notice to Transpower requiring it to provide such a release.

6. Cash Bond:

If credit support is to be provided in the form of a cash bond, the following provisions will apply:

(a) **New Zealand Dollars:**

the cash bond is to be paid in New Zealand dollars;

(b) **Cash Bond on Trust:**

Transpower will hold the cash bond on trust for the Customer in accordance with the following rules:

- (1) Transpower will establish a trust account with a registered bank in New Zealand (“the Bank”) for the purpose of holding cash bonds received from customers (“Trust Account”);
- (2) the Customer’s cash bond will be credited to a sub-account separate from other amounts deposited into the Trust Account and identified as relating to the Customer; and
- (3) Transpower must obtain an acknowledgement from the Bank that the funds in the Trust Account are held on trust and that the Bank has no right of set-off or combination in relation to such funds;

(c) **Costs:**

Transpower may, at any time, require the Customer to pay to Transpower all reasonable costs and expenses of whatever nature incurred by Transpower in connection with opening and operating the Trust Account and holding any cash bond as credit support. The Customer will pay such costs and expenses within five Business Days of such a request; and

(d) **Interest:**

the Trust Account will bear interest at the best rate reasonably obtainable from time to time from the Bank. The amount of that interest will be paid by Transpower to the Customer, net of any withholdings required by law, in arrears on a quarterly basis.

7. Release of Credit Support:

Transpower is to release any credit support provided by the Customer under clause 2 (including repaying to the Customer the balance of any cash bond and any interest under clause 6(d)) within 10 Business Days from the date of:

- (a) the Customer having obtained an Acceptable Credit Rating and providing notice to Transpower that it has obtained an Acceptable Credit Rating;
- (b) the Customer providing alternative credit support that meets the requirements of this Schedule in substitution for credit support provided by the Customer under clause 2; or
- (c) this Agreement terminating and all amounts due under this Agreement on the part of the Customer being paid.

8. Application of Credit Support:

Transpower may (but does not have an obligation to do so) on five Business Days' notice to the Customer, call on any credit support provided by the Customer under clause 2 held by Transpower in respect of the Customer's performance of its obligations under this Agreement, and apply such credit support against any amounts due under this Agreement by or on behalf of the Customer and not paid within five Business Days from the Due Date.

9. Credit Information:

Where the Customer or any provider of credit support for the Customer seeks or has an Acceptable Credit Rating under clause 1(b), the Customer, within five Business Days from the date of receipt of any request by Transpower, is to provide all financial information about itself or such provider of credit support for the Customer (as applicable) as may be reasonably required by Transpower to enable it to assess the creditworthiness of the Customer or of that provider of credit support for the Customer. Information which may be required by Transpower includes:

- (a) management accounts (consolidated and unconsolidated);
- (b) audited financial statements (consolidated and unconsolidated);
- (c) forecast financial information;
- (d) copies of documents issued to shareholders;
- (e) particulars of any litigation, arbitration, tax claim or administrative or other proceeding in relation to the Customer or any provider of credit support for the Customer which exceeds 10 percent of the total tangible assets of the Customer or provider of credit support for the Customer (as applicable);
and

- (f) particulars of any material adverse event affecting the ability of the Customer or any provider of credit support for the Customer to pay the Charges when due.

10. **Other Information:**

Without limiting clause 9, where the Customer or credit support provider has an Acceptable Credit Rating under clause 1(b), the Customer is to inform Transpower as soon as practicable on the happening of any of the following in relation to the Customer or any provider of credit support for the Customer:

(a) **Sale of Assets:**

the sale of more than 10 percent of its total tangible assets;

(b) **Increase in Assets Charged:**

any increase by 10 percent or more of the proportion of its total tangible assets charged under any security granted in favour of any other person; or

(c) **Material Adverse Event:**

any material adverse event affecting the ability of the Customer or provider(s) of credit support for the Customer to pay the Charges when due.

11. **External Credit Rating:**

Where the Customer or credit support provider has an Acceptable Credit Rating under clause 1(a), the Customer is to inform Transpower as soon as practicable on the happening of any change in its external credit rating or on being put on negative credit watch.

12. **Confidentiality of Credit Information:**

Clause 22 of Part A2 of this Agreement applies to any information provided by the Customer under clauses 9, 10 and 11 and, in addition, Transpower is not to disclose such information except to such of its employees, directors, officers and professional advisers who need to know for the purposes of assessing, or receiving advice on, any matter in relation to appendix 1 of this Schedule (Credit Policy) (including all Transpower internal decision making requirements). For the avoidance of doubt, clause 22.4 of Part A2 of this Agreement applies to disclosures by Transpower of such information in accordance with this clause 12.

APPENDIX 1 CREDIT POLICY

1. Credit Rating Calculation

Transpower will determine a credit rating for the Customer as set out below.

Based on externally sourced, industry related data, Transpower will assign a rating (either AA, A, BBB, BB or B) to the score obtained on each financial ratio referred to in the table below. This is then given a numeric value as follows:

AA or better	= 5
A	= 4
BBB	= 3
BB	= 2
B	= 1

Each value is then multiplied by the weighting ascribed by Transpower, acting reasonably, to each financial ratio. The sum of the weighted values is calculated and a rating assigned on the basis of BB or better = Category A and worse than BB = Category B. If Transpower assigns a category A rating (being a 2 or better) the Customer will not be required to provide credit support. If Transpower assigns a category B rating (being less than 2) the Customer will be required to provide credit support.

The financial ratios used in this calculation are set out in the following table and are based on Standard & Poor's *Corporate Rating Criteria*.

Key Ratios	Descriptions
1. Pre-Tax Interest Coverage	<p><u>Pre-tax income from continuing operations + interest expense</u> Gross interest</p> <p>Pre-tax income from continuing operations = earnings before interest & tax + net interest</p> <p>Interest expense = interest incurred minus capitalised interest, plus amortisation of capitalised interest</p> <p>Gross interest = gross interest incurred before subtracting (1) capitalised interest, (2) interest income</p>

2. Total Debt to Total Capital	<p><u>Total debt</u> Total capital</p> <p>Total debt = long term debt plus current maturities, commercial paper, and other short term borrowings</p> <p>Total capital = debt + equity</p>
3. Funds from Operations Gross Interest Cover	<p><u>Funds from operations</u> Gross interest</p> <p>Funds from operations = net income from continuing operations plus depreciation, amortisation, deferred income tax and other non-cash expenses</p> <p>Gross interest = gross interest incurred before subtracting (1) capitalised interest, (2) interest income</p>
4. Funds from Operations to Total Debt	<p><u>Funds from operations</u> Total debt</p> <p>Funds from operations = net income from continuing operations plus depreciation, amortisation, deferred income tax and other non-cash expenses</p> <p>Total debt = long term debt plus current maturities, commercial paper, and other short term borrowings</p>
5. Net Cash Flow to Capital Expenditure	<p><u>Net cash flow</u> Capital expenditure</p> <p>Net cash flow = funds from operations less preferred and common dividends</p> <p>Capital expenditure = net capital expenditure</p>

Transpower will score the Customer's financial ratios by reference to the Standard & Poors Key Utility Financial Ratios (being medians for US utilities) as set out in the latest Standard & Poors *Corporate Ratings Criteria* as amended or substituted from time to time, with the threshold between each Transpower rating being the mid-point of adjacent median ratings in the Standard & Poors Key Utility Financial Ratios. Transpower will assign a numeric value of 1 to any ratio which falls below the BB threshold rating.

2. Credit Rating Adjustment

The credit rating assigned to the Customer as indicated by the financial ratio calculation may be adjusted up or down on account of additional information which, in the reasonable view of Transpower, is important. This may include factors such as: market share, competitive position, regulatory risk, customer base, risk management systems, debt profile, operating efficiency, cost structure, management experience and quality, payment history, fixed asset quality and capacity, debtor quality, financial flexibility, developments in the industry which impact on credit risk.

3. Expert

If the Customer disputes:

- (a) a credit rating assigned to it by Transpower under clause 1(b) of Schedule 7; or
- (b) how the weightings of financial ratios are ascribed by Transpower in accordance with paragraph 1 of this appendix,

the Customer may by notice to Transpower refer the matter to an expert for determination in accordance with clause 21.6 of Part A2 of this Agreement. The procedure under clause 21.3 of Part A2 of this Agreement will commence from the date Transpower receives the notice referred to above.

APPENDIX 2
GUARANTEE

To: **TRANSPOWER NEW ZEALAND LIMITED (“Transpower”)**

Attention: [name]

Dear Sir/Madam

1. [Bank] (“the Bank”) refers to each and every obligation of [Customer’s full name] (“the Principal”) pursuant to the transmission agreement between Transpower and the Principal dated [] (“the Agreement”) to pay amounts the Principal, now or at any time, owes to, and is invoiced by, Transpower together with default interest, if any, in relation to such amounts (“the Obligations”) pursuant to the Agreement.
2. The Bank hereby unconditionally guarantees the payment to Transpower on demand of an amount specified in each such demand provided that:
 - (a) the aggregate liability of the Bank under this guarantee will not exceed [] (the “Maximum Amount”); and
 - (b) Transpower’s demand is made in writing and is purported to be signed by an authorised signatory; and
 - (c) a certificate purported to be signed by Transpower’s authorised signatory and certifying that the Principal has failed, in whole or in part, to fulfil the Obligations accompanies Transpower’s demand, which certificate will be conclusive proof of such failure.
3. This guarantee will not be affected, discharged or diminished by any act or omission which would, but for this provision, have exonerated a guarantor but would not have affected or discharged the Bank’s liability had it been a principal debtor.
4. Subject to paragraph 5 below, this guarantee will continue in force until the date at which the Agreement has terminated and all amounts due under the Agreement on the part of the Principal are paid at which time Transpower will return this guarantee to the Bank.
- [5. Notwithstanding anything else in this guarantee, the Bank may at any time pay Transpower the Maximum Amount less any amount or amounts the Bank may previously have paid under this guarantee or such lesser sum as Transpower may

require. Upon payment of that sum, the liability of the Bank under this guarantee will cease and determine].

[Note: Bank to elect either this clause or the following clause as a method of cancellation].

[5. Notwithstanding anything else in this guarantee, the Bank may cancel this guarantee as to subsequent liability by giving ninety (90) days' notice in writing to Transpower; however, the Bank will remain liable with respect to the Obligations which relate to the period prior to the effective date of the ninety (90) days' notice.]

6. This guarantee may be assigned by Transpower without the Bank's consent.

7. This guarantee will be governed by and interpreted in all respects in accordance with New Zealand law and the parties hereto irrevocably submit to the non-exclusive jurisdiction of the courts of New Zealand.

8. The Bank appoints [insert name and address] to receive, for it and on its behalf, service of process of any proceedings in New Zealand at that address (and such appointment shall only be revocable if contemporaneously with such revocation the Bank appoints a substitute process agent in New Zealand acceptable to Transpower). Such service shall be completed on delivery to that process agent (whether or not it is forwarded to and received by the Bank). If for any reason such process agent ceases to be able to act as such, or no longer has an address in New Zealand, the Bank shall appoint a substitute process agent acceptable to Transpower, and deliver a copy of the new process agent's acceptance of that appointment, within thirty (30) days. The Bank irrevocably consents to any process in any proceedings being served by delivering a copy to the Bank at its address for service of notices set out in this clause.

[Note: to be inserted and completed if the Bank does not have an address in New Zealand where legal proceedings may be served.]

9. This guarantee shall take effect and shall be executed as a Deed.

EXECUTED for and on behalf)
of [BANK])
by its Attorneys)
[Print Names]) Signature(s)

.....

in the presence of:

.....

Signature

.....

Full Name

.....

Address

.....

Occupation

.....

Signature(s)

APPENDIX 3
LETTER OF CREDIT

To: **TRANSPOWER NEW ZEALAND LIMITED**

Attention: [name]

Dear Sir/Madam

We, [Bank] (“the Bank”) hereby issue our irrevocable transferable standby letter of credit (“the Letter of Credit”) as follows:

IRREVOCABLE TRANSFERABLE STANDBY LETTER OF CREDIT NO. [number]

DATED [date]

The Account Party: [transmission counterparty] (“the Account Party”)

Beneficiary: Transpower New Zealand Limited (“the Beneficiary”)

Issued in Connection With: Each and every obligation (“the Obligations”) of the Account Party to pay the amounts it, now or at any time, owes to, and is invoiced by, the Beneficiary together with default interest, if any, in relation to such amounts pursuant to the transmission agreement between the Beneficiary and the Account Party dated [] (“the Agreement”).

Maximum Amount: [] less the amount of any sums drawn under this Letter of Credit.

Expiry: This Letter of Credit expires on the earliest of:

- (a) the date at which the Agreement has terminated and all amounts due under the Agreement on the part of the Account Party are paid;
- (b) the date of satisfaction of this Letter of Credit in accordance with its terms;

[(c) the date on which the Bank makes payment to the Beneficiary of the Maximum Amount either at its sole discretion or following demand by the Beneficiary under this Letter of Credit in accordance with its terms],

[Note: Bank to elect either this clause or the following clause as a method of cancellation.]

[(c) ninety (90) days after notice in writing of cancellation of this Letter of Credit as to subsequent liability has been given to Transpower; however, the Bank will remain liable with respect to the Obligations which relate to the period prior to the effective date of the ninety (90) days' notice.]

(“the Expiry Date”).

Payable at: Sight.

Available at: [address]

By Drafts on: The Bank.

Enfaced: Drawn under [Bank] Irrevocable Standby Letter of Credit No. [number] dated [date].

Returnable to: The Bank upon expiry.

The proceeds of this Letter of Credit are transferable by the Beneficiary. A claim may be made under this Letter of Credit by delivering to the address at which this Letter of Credit is expressed to be available, by no later than [time] New Zealand time on or before the Expiry Date, draft drawn on the Bank (enfaced as specified above) accompanied by:

- (a) This Letter of Credit; and
- (b) A Certificate purported to be signed by an authorised signatory of the Beneficiary in the following form:

To [Bank] [date]

Transpower New Zealand Limited of [address] (“the Beneficiary”) hereby makes claim under the [Bank] Irrevocable Standby Letter of Credit No [number] (“the

Letter of Credit”). Words and expressions defined in the Letter of Credit will have the same meaning herein.

[Payer] (“the Account Party”) has failed, in whole or in part, to fulfil the Obligations.

As at the date of this Certificate, the amount owed to the Beneficiary by the Account Party in respect of the Obligations is the sum of [amount outstanding].

Accordingly, the Beneficiary is entitled to claim and hereby requests payment by [date] of the amount of [amount claimed] to be credited to account number [Beneficiary’s trust account number].

The signatory or signatories hereto is/are authorised by the Beneficiary to make the statements herein on behalf of the Beneficiary.

Signed.....

Authorised Signatory

This Letter of Credit is subject to the Uniform Customs and Practice for Documentary Credits (1993 Revision) International Chamber of Commerce Publication No. 500, except as otherwise provided in this Letter of Credit. Subject to that, this Letter of Credit will be governed by, and construed in accordance with, the laws of New Zealand, and the parties hereto irrevocably submit to the non-exclusive jurisdiction of the courts of New Zealand.

The Bank engages with the Beneficiary that drafts drawn under, and in compliance with, this Letter of Credit and, in aggregate, up to the Maximum Amount will be paid on presentation in the manner provided in this Letter of Credit.

The Bank appoints [insert name and address] to receive, for it and on its behalf, service of process of any proceedings in New Zealand at that address (and such appointment shall only be revocable if contemporaneously with such revocation the Bank appoints a substitute process agent in New Zealand acceptable to the Beneficiary). Such service shall be completed on delivery to that process agent (whether or not it is forwarded to and received by the Bank). If for any reason such process agent ceases to be able to act as such, or no longer has an address in New Zealand, the Bank shall appoint a substitute process agent acceptable to the Beneficiary, and deliver a copy of the new

process agent's acceptance of that appointment, within thirty (30) days. The Bank irrevocably consents to any process in any proceedings being served by delivering a copy to the Bank at its address for service of notices set out in clause.

[Note: to be inserted and completed if the Bank does not have an address in New Zealand where legal proceedings may be served.]

This Letter of Credit shall take effect and be executed as a Deed.

EXECUTED for and on behalf)
of [BANK])
by its Attorneys)
[Print Names]) Signature(s)

.....

in the presence of:

.....

Signature

.....

Full Name

.....

Address

.....

Occupation

APPENDIX 4
DEED OF GUARANTEE AND INDEMNITY

DATED

BY

(1) [] (the “Guarantor”)

IN FAVOUR OF

(2) **TRANSPOWER NEW ZEALAND LIMITED** (the “Beneficiary”)

1. GUARANTEE AND INDEMNITY

1.1 The Guarantor:

- (a) unconditionally and irrevocably guarantees to the Beneficiary the due performance and observance by [transmission counterparty] (“the Debtor”) of each and every obligation the Debtor may now or hereafter have to the Beneficiary to pay amounts it owes to, and is invoiced by, the Beneficiary (whether as principal or agent) together with default interest, if any, in relation to such amounts (“the Obligations”) pursuant to the transmission agreement between Transpower and the Debtor dated [] (“the Agreement”) and promises to pay to the Beneficiary on demand all amounts now or hereafter owing, due or payable by the Debtor to the Beneficiary in respect of the Obligations; and
- (b) agrees as a primary obligation to indemnify the Beneficiary from time to time on demand from and against any loss incurred by the Beneficiary as a result of any of the Obligations being void, voidable or unenforceable for any reason whatsoever, whether or not known to the Beneficiary, the amount of such loss being the amount which the Beneficiary would otherwise have been entitled to recover from the Debtor.

1.2 This Deed is to be security in respect of each and every one of the Obligations but, nevertheless, the total amount payable by the Guarantor under this Deed will not exceed the aggregate of the [] (the “Maximum Amount”) and any sums payable pursuant to clauses 1.3 and 9.1 of this Deed.

1.3 If any moneys payable by the Guarantor under this Deed are not paid on demand, the Guarantor will pay to the Beneficiary interest on such unpaid moneys (both before and after judgement) at the rate determined in accordance with clause 1.4 of this Deed from the date of demand to the date of their actual receipt by the

Beneficiary calculated on a daily basis and capitalised as the Beneficiary will determine.

- 1.4 The rate at which interest will be calculated will be the aggregate of 5% per annum plus the then prevailing settlement bid rate for 90 day bills displayed on Reuters Screen BKBM at 10:45am on the date of demand or, if for any reason that rate is not displayed, the rate determined by the Beneficiary to be the nearest practicable equivalent.

2. PRESERVATION OF RIGHTS

- 2.1 The obligations of the Guarantor under this Deed are in addition to, and not in substitution for, any other security or guarantee which the Beneficiary may at any time hold in respect of the Obligations or any of them and may be enforced without the Beneficiary first having recourse to any such security and without the Beneficiary first taking steps or proceedings against the Debtor.
- 2.2 Neither the obligations of the Guarantor under this Deed nor the rights, powers and remedies conferred in respect of the Guarantor upon the Beneficiary by this Deed or by law will be discharged, impaired or otherwise affected by anything which might operate to discharge, impair or otherwise affect the same, including:
- (a) the insolvency, liquidation or dissolution of the Debtor or any other person, the appointment of any receiver, manager, receiver and manager, inspector, trustee, statutory manager or other similar person in respect of the Debtor or any other person or any change in the Debtor's status, function, control or ownership;
 - (b) the Obligations or any of them, or the obligations of any person under any security or guarantee held in relation to the Obligations or any of them, being or becoming in whole or in part void, voidable, defective, illegal, invalid or unenforceable in any respect or ranking after any other security;
 - (c) any time, credit or other indulgence or other concession being granted or agreed to be granted by the Beneficiary to, or any composition or other arrangement made with or accepted from, the Debtor in respect of the Obligations or any of them or the obligations of any person under any security or guarantee held in relation to the same;
 - (d) any variation of the terms of any of the Obligations or of any security or guarantee (including this guarantee) held in relation to the same;
 - (e) any failure to realise or fully realise the value of, or any release, discharge, exchange or substitution of, any security or guarantee held in relation to the Obligations or any of them;

- (f) any failure (whether intentional or not) to take, fully take or perfect any security now or hereafter agreed to be taken by the Beneficiary in relation to the Obligations or any of them; and
 - (g) any other act, event or omission which, but for this clause 2.2, would or might operate or discharge, impair or otherwise affect any of the obligations of the Guarantor under this Deed or any of the rights, powers or remedies conferred upon the Beneficiary by the Agreement or by law.
- 2.3 If any payment to the Beneficiary under this Deed is avoided by law, the Guarantor's obligation to have made such payment will be deemed not to have been affected or discharged and the Guarantor will on demand indemnify the Beneficiary against all costs sustained or incurred by the Beneficiary as a result of it being required for any reason to refund all or part of any amount received or recovered by it in respect of such payment and will in any event pay to the Beneficiary on demand the amount so refunded by it. The Beneficiary and the Guarantor will, in any such case, be deemed to be restored to the position in which each would have been and will be entitled to exercise the rights they respectively would have had if that payment had not been made.
- 2.4 The Beneficiary is not obliged before exercising any of the rights, powers or remedies conferred upon it in respect of the Guarantor by law to make any demand on the Debtor, take any action or obtain judgment in any court against the Debtor, make or file any claim or prove in any liquidation of the Debtor or enforce or seek to enforce any security or guarantee taken in respect of the Obligations.
- 2.5 After a demand has been made by the Beneficiary under this Deed, and so long as the Guarantor is under any actual or contingent liability under this Deed, the Guarantor will not:
- (a) exercise in respect of any amount paid by the Guarantor under this Deed any right of subrogation or any other right or remedy which the Guarantor may have in respect of such amount paid;
 - (b) except with the Beneficiary's consent in writing, claim or receive payment of any other moneys for the time being due to the Guarantor by the Debtor or exercise any other right or remedy which the Guarantor may have in respect of the same; or
 - (c) unless so required by the Beneficiary, prove in the liquidation of the Debtor in competition with the Beneficiary for any moneys owing to the Guarantor by the Debtor on any account whatsoever.

Any moneys obtained by the Guarantor from the Debtor with such consent or as so required or in breach of this clause will, in each case, be held by the Guarantor upon trust to pay such moneys to the Beneficiary in or towards discharge of the Guarantor's obligations under this Deed.

- 2.6 Any moneys received by the Beneficiary which may be applied in or towards discharge of any of the obligations of the Guarantor under this Deed will be regarded as a payment in gross so that, in the event of the liquidation of the Guarantor, the Beneficiary may prove in the liquidation for the whole of such moneys.

3. REPRESENTATIONS AND WARRANTIES

3.1 The Guarantor represents that:

- (a) it is duly incorporated and validly existing under the laws of [New Zealand], capable of suing and being sued and has the power to enter into and perform this Deed and has taken all necessary corporate action to authorise it to enter into, execute, deliver and perform its obligations under this Deed;
- (b) its entry into, execution, delivery and performance of this Deed will not contravene any law or regulation to which the Guarantor is subject or any provision of its constitutional documents and all things (including the obtaining of consents) requisite for such entry, execution, delivery and performance have been taken, fulfilled and done and are in full force and effect;
- (c) no obligation of the Guarantor under this Deed is secured by, and the execution, delivery and performance of this Deed will not result in the existence of, or oblige it to create, any mortgage, charge, pledge, lien or other encumbrance over any of its present or future revenues or assets; and
- (d) the execution, delivery of and performance of the Guarantor's obligations under this Deed will not cause the Guarantor to be in breach of or in default under any agreement binding on the Guarantor or any of its assets and no material litigation or administrative proceeding before, by or of any court or governmental authority is pending or (so far as the Guarantor knows) threatened against the Guarantor or any of its assets which, if decided against the Guarantor, would have a material adverse effect on the ability of the Guarantor to meet any or all of the obligations hereunder.

4. PAYMENTS

- 4.1 All payments to be made by the Guarantor to the Beneficiary under this Deed will be made without set-off or counterclaim and without any deduction or withholding whatsoever. If the Guarantor is obliged by law to make any deduction or withholding from any such payment, the amount due from the Guarantor in respect of such payment will be increased to the extent necessary to ensure that, after the making of such deduction or withholding, the Beneficiary receives a net amount equal to the amount the Bank would have received had no such deduction or withholding been required to be made.

5. CONTINUING SECURITY

- 5.1 This Deed will be a continuing security to the Beneficiary in respect of each and every one of the Obligations and will not be (or be construed so as to be) discharged by any intermediate discharge or payment of or on account of the Obligations or any settlement of accounts between the Beneficiary and the Debtor or anyone else.

6. TERMINATION

- [6.1 Notwithstanding anything else in this Deed, the Guarantor may at any time pay to the Beneficiary the Maximum Amount less any amount or amounts the Guarantor may previously have paid under this Deed or such lesser sum as the Beneficiary may require. Upon payment of that sum, the liability of the Guarantor under this Deed will cease and determine.]

[Note: Guarantor to elect either this clause or the following clause as a method of cancellation.]

- [6.1 Notwithstanding anything else in this Deed the Guarantor may cancel this Deed as to subsequent liability by giving ninety (90) days' notice in writing to the Beneficiary; however, the Guarantor will remain liable with respect to the Obligations which relate to the period prior to the effective date of the ninety (90) days' notice.]

7. ASSIGNMENT

- 7.1 This Deed may be assigned by the Beneficiary without the Guarantor's consent.

8. NOTICES

- 8.1 Any demand to be made on the Guarantor by the Beneficiary under this Deed may be made in writing and delivered to the address set out below or to any

other address in New Zealand from time to time notified pursuant to clause 8.2.
The Guarantor's address, as at the date of this Deed is: [address]

8.2 The Guarantor will immediately notify the Beneficiary of any change in the above address.

9. COSTS AND EXPENSES

9.1 The Guarantor will on demand indemnify and hold harmless the Beneficiary from and against all costs and expenses (including legal fees and any taxes or duties) incurred by the Beneficiary in the enforcement and protection of its rights under this Deed.

10. GOVERNING LAW

10.1 This Deed is governed by, and construed in accordance with New Zealand law, and the Guarantor hereby irrevocably submits to the non-exclusive jurisdiction of the New Zealand Courts.

11. PROCESS AGENT

11.1 The Guarantor appoints [insert name and address] to receive, for it and on its behalf, service of process of any proceedings in New Zealand at that address (and such appointment shall only be revocable if contemporaneously with such revocation the Guarantor appoints a substitute process agent in New Zealand acceptable to the Beneficiary). Such service shall be completed on delivery to that process agent (whether or not it is forwarded to and received by the Guarantor). If for any reason such process agent ceases to be able to act as such, or no longer has an address in New Zealand, the Guarantor shall appoint a substitute process agent acceptable to the Beneficiary, and deliver a copy of the new process agent's acceptance of that appointment, within thirty (30) days. The Guarantor irrevocably consents to any process in any proceedings being served by delivering a copy to the Guarantor at its address for service of notices set out in this clause.

[Note: to be inserted and completed if the Guarantor does not have an address in New Zealand where legal proceedings may be served.]

This Deed shall take effect and be executed as a Deed.

EXECUTED for and on behalf)
of [Guarantor])
in the presence of:)

.....

Director

Director/Authorised Signatory

.....

Signature

.....

Full Name

.....

Address

.....

Occupation

Note I: If two directors sign, no witness is necessary. If a director and authorised signatory sign, both signatories are to be witnessed. If the director and authorised signatory are not signing together, a separate witness will be necessary for each signature.

Note II: If the Guarantor is incorporated outside of New Zealand, insert an appropriate execution clause for the country of incorporation.

APPENDIX 5
SURETY BOND

To: **TRANSPOWER NEW ZEALAND LIMITED (“Transpower”)**

Bond Number:

We, [name of transmission counterparty] as Principal, and [name and address of Surety], as Surety, are held and firmly bound to Transpower, a corporation organised and existing under the laws of New Zealand, its successors and assigns, in the amount of [amount in words] New Zealand dollars (NZ\$[]), lawful money of New Zealand for the payment of which the Principal and Surety, their heirs, executors, administrators, successors and assigns are hereby jointly and severally bound.

The Principal has obligations (the “Obligations”) pursuant to the transmission agreement between Transpower and the Principal dated [] (“the Agreement”) to pay Transpower amounts invoiced to it by Transpower;

The Surety agrees to deliver payment to Transpower of amounts invoiced to the Principal (together with any default interest payable in respect of those invoiced amounts) forthwith upon receipt of written demand for payment issued by a purported authorised representative of Transpower. Such written demands to be delivered to the Surety at its above address and to certify that the Principal has failed, in whole or in part, to fulfil the Obligations.

The Surety will not be liable hereunder for a larger amount, in the aggregate, than the amount of this Bond; and

[The Surety may at any time pay to Transpower the amount of this Bond less any amount or amounts the Surety may previously have paid under this Bond or such lesser sum as Transpower may require. Upon payment of that sum, the liability of the Surety under this Bond will cease and determine; and]

[Note: Surety to elect either this proviso or the following proviso as a method of cancellation.]

[This Bond may be cancelled by the Surety as to subsequent liability by giving ninety (90) days’ notice in writing to Transpower; however, the Surety will remain liable with respect to the

Principal's Obligations which relate to the period prior to the effective date of the ninety (90) days' notice; and]

This Bond will not be affected, discharged or diminished by any act or omission which would, but for this provision, have exonerated a surety but would not have affected or discharged the Surety's liability had it been a principal debtor; and

This Bond will be governed by and interpreted according to, the laws of New Zealand, and the Principal and the Surety thereby agree to submit to the non-exclusive jurisdiction of the Courts of New Zealand.

This Bond may be transferred or assigned by Transpower without the Surety's consent. Upon cancellation, the Bond will be returned to the Surety.

[The Surety appoints [insert name and address] to receive, for it and on its behalf, service of process of any proceedings in New Zealand at that address (and such appointment shall only be recoverable if contemporaneously with such revocation the Surety appoints a substitute process agent in New Zealand acceptable to Transpower. Such service shall be completed on delivery to that process agent (whether or not it is forwarded to and received by the Surety). If for any reason such process agent ceases to be able to act as such or no longer has an address in New Zealand the Surety shall appoint a substitute process agent acceptable to Transpower, and deliver a copy of the new process agent's acceptance of that appointment, within thirty (30) days. The Surety irrevocably consents to any process in any proceedings being served by delivering a copy to the Guarantor at its address for service of notices set out in clause.]

[Note: to be inserted and completed if the Surety does not have an address in New Zealand where legal proceedings may be served.]

This Surety Bond shall take effect and be executed as a Deed

EXECUTION CLAUSE

SCHEDULE 8 CONNECTION CODE

1. INTERPRETATION

1.1 Preliminary:

Nothing in this Connection Code limits or derogates from any provision of the Agreement.

1.2 Definitions:

In this Connection Code, unless the context otherwise requires:

Earth Fault Factor

means at a given location of a three-phase electrical power system, and for a given system configuration, the ratio of:

- (a) the highest r.m.s. phase-to-earth power frequency voltage on a healthy phase during a fault to earth affecting one or more phases at any point on the system; to
- (b) the r.m.s value of phase-to-earth power frequency voltage which would be obtained at the given location in the absence of any such fault.

Equipment

means any of:

- (a) **assets** or a **network** physically connected to the **grid**;
- (b) **assets** or a **network** forming part of the **grid**;
- (c) **assets** or a **network** not physically connected to the **grid** but which, in the reasonable opinion of **Transpower**, can affect the management, security, operation or performance characteristics of the **grid**; or
- (d) other equipment not physically connected to the **grid** but which, in the reasonable opinion of **Transpower**, can affect the security or operation of the **grid**, or power quality.

Power Factor

means MW divided by MVA at a Customer Point of Service where the MW and MVA are measured.

Safety Manual - Electricity Industry (SM-EI)

means the Safety Manual – Electricity (SM-EI), published by the Electricity Engineers' Association (as may be amended from time to time).

Secondary Plant

all Equipment that is not **primary transmission equipment**.

1.3 Interpretation:

References to **Transpower** are references to **Transpower** in its capacity as **grid owner** as a party to the Agreement. References to the Customer are references to the Customer in its capacity as a party to the Agreement. References to clauses are to clauses of this Connection Code, unless the context otherwise requires.

1.4 Procedure for obtaining Transpower's agreement to non compliance:

Transpower may enter into an agreement with the Customer as to the manner and extent by which the Customer need not comply with this Connection Code in accordance with the process set out in Appendix A. If the agreement would have a material adverse effect on any other **designated transmission customer** or end use customer, **Transpower** and the Customer must first comply with clauses 12.35 to 12.38 of the Code, as applicable, before entering into the agreement.

If an agreement is entered into, **Transpower** and the Customer must comply with that agreement. A non-confidential summary of that agreement must be made publicly available.

1.5 Customer's responsibilities for third parties:

- (a) The Customer must ensure that any third party who has Equipment directly connected to the Customer's Equipment, but not to the **grid**, that may adversely affect the reliability, availability or integrity of the **grid** complies with the obligations on the Customer as set out in this Connection Code.
- (b) For the purposes of this clause, but without limiting the application of subclause (a), any **generating units** with a combined installed capacity of greater than 1MW, or motors with a combined installed capacity of greater than 1MW capacity will be treated as having the potential to adversely affect the reliability, availability or integrity of the grid, unless **Transpower** and the Customer agree that a higher capacity is more appropriate taking into account the load at a **point of connection**.

1.6 Customer's responsibilities when other designated transmission customer

If the Customer is requested by another **designated transmission customer** or **Transpower** to agree to the bonding of that **designated transmission customer's** earthing systems as required by the equivalent clause to clause 4.2(d)(4) that applies under any **transmission agreement** between the Customer and **Transpower**, the Customer must not unreasonably withhold that agreement.

2. CONNECTION REQUIREMENTS

2.1 Requirements for equipment capability:

As and when the Customer must provide an **asset capability statement** to the **system operator** under the Code, the Customer must also provide the same **asset capability statement** to **Transpower** (in the same manner in which it provides the **asset capability statement** to the **system operator**) but including the information specified in clause 2.2 (b), (c) and (d).

2.2 Additional information:

The Customer must provide to **Transpower**, in a format specified by **Transpower** (acting reasonably) from time to time:

- (a) as and when it must provide an **asset capability statement** to the **system operator** under the Code, the information referred to in subclauses 2.2(b), (c) and (d) in respect of that Equipment.
- (b) in respect of its Equipment:
 - (1) the normal and emergency limits within which the Equipment is intended to operate;
 - (2) the information as to the limitations in the operation of the Equipment that **Transpower** requires (acting reasonably) for the safe and efficient management of the **grid**; and
 - (3) all modelling data in respect of Equipment capability which **Transpower** requires (acting reasonably) for planning purposes;
- (c) sufficient information concerning the Equipment at the **grid interface** to verify compliance with this Connection Code and to enable **Transpower** to approve the connection; and
- (d) details of protection systems, including settings, to ensure the requirements of clause 4.2(e) are met.

2.3 Special requirements:

If the Customer proposes to connect Equipment to the **grid**, or to **assets** connected to the **grid**, or to make changes to Equipment connected to the **grid** or to **assets** connected to the **grid** and **Transpower**:

- (a) acting reasonably and after having consulted other Customers who may be affected by the connection of the Equipment to the **grid**, or the changes to the Equipment or otherwise; or
- (b) having regard to the environmental conditions in which the Equipment at the **grid interface** is located;

identifies special requirements for the Equipment, **Transpower** may notify the Customer of the special requirements and the Customer must ensure those special requirements are complied with to **Transpower's** satisfaction (acting reasonably).

2.4 Pre-commissioning requirements:

- (a) Before the Customer commissions any Equipment to be connected to the **grid**, or any **asset** connected to the **grid**, the Customer must obtain **Transpower's** written approval (not to be unreasonably withheld):
 - (1) to the design and specifications of the Equipment;
 - (2) that the requirements of this Connection Code can be met;
 - (3) that upon connection of the Equipment, the reliability, availability and integrity of the **grid** can be maintained; and
 - (4) that the proposed connection of the Equipment can be made reliably and safely without any material adverse affect on the management, security or operation of the **grid**.
- (b) In considering whether or not to grant approval **Transpower** may (amongst other things) consider:
 - (1) the effect of daily, seasonal, annual and likely long-term variations in supply and demand levels;
 - (2) the effect of contingency conditions; and
 - (3) the effect of any future changes required to the **grid**, or to other Equipment.

2.5 Requirements for commissioning or testing of equipment:

- (a) The Customer must:

- (1) as and when the Customer must provide a commissioning or test plan to the **system operator** under the Code, also provide a commissioning or test plan to **Transpower** that complies with clause 2.6; and
 - (2) if the Equipment is not connected to the **grid** but is connected to an asset connected to the **grid** and in the reasonable opinion of **Transpower**, could affect the security or operation of the **grid**, the Customer must provide to **Transpower** a commissioning or test plan that complies with clause 2.6.
- (b) **Transpower** must, as and when required to provide a commissioning or test plan under the Code in respect of the Connection Assets, also provide a commissioning or test plan to the Customer that complies with paragraphs (a) to (d) of clause 2.6.

2.6 Requirements of a commissioning or test plan:

The commissioning or test plan required under clause 2.5 must:

- (a) include a timetable containing the sequence of events necessary to connect the Equipment and conduct any test;
- (b) contain the protection settings to be applied before livening of the Equipment;
- (c) contain the procedures for commissioning or testing the Equipment that safeguards against risk of injury to personnel or damage to any Equipment and to the ability of **Transpower** and the Customer to comply with its obligations under the Agreement;
- (d) have been prepared by the Customer in consultation with **Transpower** or by **Transpower** in consultation with the Customer, as the case may be; and
- (e) in the case of a commissioning or test plan provided by the Customer, be approved in writing by **Transpower** (such approval not to be unreasonably withheld).

2.7 Customer to comply with commissioning or test plan:

The Customer in commissioning or undertaking any testing of the Equipment must comply with the commissioning or test plan approved by **Transpower** in accordance with clause 2.6.

2.8 Responsibility following approval:

The Customer must ensure that the construction or manufacture of Equipment does not depart from the design or specifications of Equipment approved by **Transpower** unless the departure is approved in writing by **Transpower**. **Transpower** will not withhold such approval unreasonably.

2.9 Final approval:

On completion of connection of any Equipment to the **grid**, including to any associated **grid interface**, the Customer must obtain final approval of such connection in writing from **Transpower** (such approval not to be unreasonably withheld) before the Equipment commences service.

2.10 Withdrawal:

Transpower may withdraw any approval provided by **Transpower** (acting reasonably) if the Equipment is not as described in the information provided under clauses 2.2 and 2.3.

2.11 Co-operation:

The Customer must comply with any reasonable direction of **Transpower** to change the connection of any Equipment to the **grid** (or the Equipment itself), if the connection or the Equipment may adversely affect the performance of the **grid** or the Equipment of other customers.

2.12 New Connections:

Where the Customer wishes **Transpower** to provide a new connection, it must make a written request to **Transpower** and **Transpower** must within 20 Business Days of the Customer's request provide an initial response in writing to the Customer that sets out the process to be followed by **Transpower** and the Customer and a proposed timetable for provision of the new connection.

3. GENERAL REQUIREMENTS

3.1 Published requirements:

Transpower must ensure that its Connection Assets (and, in the case of subclauses (b) and (c), the operation of its Connection Assets) and the Customer must each ensure that its Equipment (and, in the case of subclauses (b) and (c), the operation of its Equipment):

- (a) is designed, tested and commissioned in accordance with **good electricity industry practice**;
- (b) complies with the Safety Manual - Electricity Industry (SM-EI); and
- (c) complies with all relevant legislation.

4. TECHNICAL REQUIREMENTS

4.1 Instrumentation and control circuits:

The Customer:

- (a) may connect an instrumentation and control circuit to secondary plant at the **grid interface** provided:
 - (1) the **grid** is not adversely affected;
 - (2) the safety of the public and any other persons is not adversely affected; and
 - (3) the Customer has prior written approval from **Transpower** (such approval not to be unreasonably withheld).
- (b) must provide a means by which both the Customer and **Transpower** may disconnect each instrumentation or control circuit connected to the **grid**; and

Transpower must ensure that each instrumentation and control circuit connected at the **grid interface** is designed to withstand the hazards of earth potential rise and induced currents and voltages appropriate to the location of the secondary circuit and comply with the requirements of clause 4.2(d).

4.2 Requirements at the grid interface:

(a) Grid interface switchgear to be provided:

The Customer or **Transpower** must provide for each Point of Connection:

- (1) a single location where it is practicable, in accordance with **good electricity industry practice**, for the owner of the **circuit-breaker** to operate each **circuit-breaker** by remote control;
- (2) the operational status of each **circuit-breaker** to be signalled to the single location in (1) from which the **circuit-breaker** is controlled; and
- (3) Equipment to isolate and earth its own Equipment at each Point of Connection.

(b) Insulation co-ordination:

Transpower and the Customer must each ensure:

- (1) the insulation of Equipment at the **grid interface** is co-ordinated with the insulation of Equipment to which it is to be connected;
- (2) that transient, dynamic, continuous and any other over-voltages are calculated, analysed and taken into account in accordance with **good**

electricity industry practice and that the recommendations of IEC 60071 (Insulation Co-ordination) are complied with;

- (3) that the rated insulation level and rated short duration power frequency withstand voltage meets the levels specified in Appendix B Table B3; and
- (4) that for any connection of Equipment to the **grid** at a voltage of 220 kV and for each **Point of Connection**, an Earth Fault Factor of not more than 1.4 (an effectively earthed system) is maintained. For the purposes of this clause 4.2(b)(4), any Equipment connected to the **grid** that operates at a nominal voltage of less than 220 kV, is deemed to have an Earth Fault Factor of greater than 1.4 (non-effectively earthed). Any connection of such Equipment to the **grid** must not increase the Earth Fault Factor to an extent which leads to over-voltages which have an adverse effect on the management or operation of the **grid**.

(c) **Rating of equipment at the grid interface:**

Transpower and the Customer must each ensure that:

- (1) the normal current ratings of Equipment at the **grid interface** are sufficient to carry currents at all reasonably foreseeable ratings;
- (2) neither the short-circuit current ratings nor the effects of the earthing of the Equipment interfere with, or adversely affect, the management or operation of the **grid**; and
- (3) it modifies or replaces the Equipment or changes the configuration of the Equipment before any of the short-circuit current ratings of the Equipment are exceeded, in order to ensure those ratings are not exceeded.

(d) **Earthing of the grid interface:**

Transpower and the Customer must ensure that:

- (1) the earthing arrangements for the **grid interface** do not adversely affect the safety of any person;
- (2) the earthing arrangements for the **grid interface** allow the efficient management of protection systems;
- (3) the Equipment has an earthing arrangement that keeps hazards within limits required by **good electricity industry practice** without requiring bonding to the earthing systems of any other **designated transmission customer**;

- (4) without derogating from the foregoing, where bonding to the earthing systems of any other **designated transmission customer** is beneficial, undertake the bonding to the earthing system of that other **designated transmission customer** as agreed by the **designated transmission customer**; and
- (5) earthing of the Equipment at the **grid interface** is sufficient to withstand earth fault currents (including the contribution from the **grid**) up to the limits specified in Appendix B Table B2 for at least 3 seconds.

(e) **Protection of equipment and the grid:**

Transpower and the Customer must each ensure that the Equipment is designed and maintained so that, for fault impedances of less than one ohm on either the **grid** or at the **grid interface**, the following applies:

- (1) the fault will be cleared by main protection systems within the design fault clearance time specified in Appendix B table B4;
- (2) the fault clearance time for back up protection systems, including high impedance faults, is as short as reasonably practicable and does not adversely affect other Equipment, and must not exceed the final fault clearance time in Appendix B table B4; and
- (3) no fault on the **grid assets** or on the **grid interface** persists for longer than the final fault clearance time stated in Appendix B table B4.

(f) **Common and shared facilities and equipment:**

If **Transpower** and the Customer share facilities or Equipment, each shall:

- (1) physically secure the facilities or the Equipment against unauthorised access or operation by a third party;
- (2) provide electrically safe Equipment in accordance with **good electricity industry practice**; and
- (3) provide facilities and Equipment that comply with AS/NZS 1170 Structural design actions.

(g) **Expected minimum and maximum fault levels:**

Transpower must publish annually a 10 year forecast of the expected minimum and maximum fault level at each Customer Point of Service.

4.3 Specific requirements for generating units:

If the Customer is a **generator**, the Customer must ensure that the connection at the **point of connection** of its **generating units** has an Earth Fault Factor complying with the requirements of clause 4.2(b)(4) and the earthing of the generating unit and associated Equipment ensures the reliable operation of protection systems and safe management of the **grid**. This requirement also applies in respect to the **grid interface** for any **network** to which a generating unit is connected and may affect the management of the **grid**.

4.4 Minimum power factor:

- (a) The Customer must ensure that its Equipment does not unreasonably draw on the reactive power resources of the **grid** during each regional peak demand period. If **electricity** is being drawn off the **grid**, the Power Factor at any Customer Point of Service the Customer must:
- (1) up until 31 March 2010, in the case of demand, maintain a Power Factor of not less than 0.95 lagging at any Customer Point of Service during each relevant regional peak demand period.
 - (2) from 1 April 2010, in the case of demand, maintain a Power Factor of not less than:
 - (i) 1.0 (unity) at each relevant Customer Point of Service during each relevant regional peak demand period in the Upper North Island Region and the Upper South Island Region; and
 - (ii) 0.95 lagging at each relevant Customer Point of Service during each relevant regional peak demand period in the Lower North Island Region and the Lower South Island Region.
- (b) For the purposes of this clause:
- (1) the regional peak demand periods and regions are as defined in the **transmission pricing methodology** immediately before the **transmission pricing methodology** was replaced on 1 April 2023; and
 - (2) the relevant regional peak demand period is the regional peak demand period for the region in which the Customer Point of Service is located.

4.5 Provision for effects of disconnection:

The Customer must each ensure that it manages the consequences of an unplanned disconnection of any of its Equipment from the **grid assets** in accordance with **good electricity industry practice**.

4.6 Maintenance:

Transpower and the Customer must each maintain its Equipment so that it always complies with this Connection Code.

4.7 Harmonic levels:

Transpower and the Customer must each comply with:

- (a) the New Zealand Electrical Code of Practice for harmonic levels (NZECP 36.1993), as amended from time to time; or
- (b) any other equivalent or similar AS/NZS, IEC, IEEE standard; or
- (c) any other requirements specified by **Transpower** (acting reasonably) that cover similar matters to those set out in NZECP 36.1993.

4.8 Voltage flicker levels:

Transpower and the Customer must each comply with the Australian Standard (AS2279.4 191) for voltage levels as amended from time to time or such other local or international standards that may be reasonably applicable.

4.9 Voltage imbalance of less than 1%:

Transpower and the Customer must each use reasonable endeavours to maintain negative sequence voltage of less than 1% and to ensure that negative sequence voltage will be no more than 2% in any part of the **grid**.

5. OPERATING REQUIREMENTS

5.1 Operational performance of equipment:

Transpower and the Customer must each ensure that its Equipment:

- (a) has no adverse effect on the **grid** or the ability of **Transpower** to manage the **grid**;
- (b) can be operated within the minimum and maximum system voltages set out in Appendix B, Table B1;
- (c) has no adverse effect on other Customers or their ability to manage their Equipment;
- (d) is designed and installed so that maintenance can be carried out;
- (e) does not present a safety hazard to **Transpower** or other Customers (or their respective employees and agents) or the general public;

- (f) does not cause **Transpower** or the Customer to breach any legislation;
- (g) performs its intended function to the standard required by this Connection Code at the maximum and minimum short-circuit currents resulting from any reasonably foreseeable configuration of the New Zealand electricity system;
- (h) does not cause the maximum short circuit power and current limits specified in Appendix B, Table B2 to be exceeded on or nearby to the **grid**;
- (i) is capable of being operated and operates within the limits stated in the **asset capability statement** and other information provided under clauses 2.1 and 2.2 respectively;
- (j) complies with this Connection Code; and
- (k) meets any other requirements imposed by **Transpower** in writing acting reasonably and in accordance with **good electricity industry practice**.

6. MONITORING REQUIREMENTS

6.1 Monitoring requirements:

Transpower and the Customer must each monitor the performance of its Equipment in accordance with **good electricity industry practice**.

7. INFORMATION REQUIREMENTS

7.1 For approval of the grid interface:

- (a) In addition to information provided in the **asset capability statement** and the other information provided under clauses 2.2 and 2.3 respectively, the Customer must provide **Transpower** as and when requested by **Transpower** (acting reasonably) with:
 - (1) sufficient information concerning the **grid interface** to verify compliance with this Connection Code and to enable **Transpower** to approve the connection at the **grid interface**;
 - (2) details of protection systems, including settings, to ensure the requirements of clause 4.2 (ef) are met; and
- (b) **Transpower** must provide the Customer as and when requested by the Customer (acting reasonably) with details of protection systems relating to the Connection Assets, including settings, to ensure the requirements of clause 4.2(e) are met.

7.2 For revisions to information previously supplied:

- (a) Whenever revised information as to the performance of Equipment is obtained by the Customer, the Customer must provide to **Transpower** a revised **asset capability statement** and any revisions to the other information required under clauses 2.2 and 2.3 respectively, as soon as reasonably practicable.
- (b) Whenever revised information as to the performance of a Connection Asset is obtained by **Transpower**, **Transpower** must provide to the Customer a revised **asset capability statement** and any revisions to the other information required under clauses 2.2 and 2.3 respectively, as soon as reasonably practicable.

7.3 Supporting information:

- (a) The Customer must maintain up to date manuals or protocols required in accordance with **good electricity industry practice** for the operation of its Equipment.
- (b) **Transpower** must maintain up to date manuals or protocols required in accordance with **good electricity industry practice** for the operation of its Connection Assets.

7.4 Equipment records to be kept:

- (a) The Customer must in accordance with **good electricity industry practice** maintain records for its Equipment that, in its discretion, either:
 - (1) record the performance of its Equipment as monitored by the Customer over each consecutive three month period for the purpose of verifying or otherwise that the Equipment meets the requirements of this Connection Code; or
 - (2) record any tests undertaken in accordance with **good electricity industry practice** that establish that the Equipment meets the requirements of this Connection Code.
- (b) **Transpower** must in accordance with **good electricity industry practice** maintain records for its Connection Assets that, in its discretion, either:
 - (1) record the performance of its Connection Assets as monitored by the **Transpower** over each consecutive three month period for the purpose of verifying or otherwise that the Connection Assets meets the requirements of this Connection Code; or

- (2) record any tests undertaken in accordance with **good electricity industry practice** that establish that the Connection Assets meets the requirements of this Connection Code.

7.5 Access to records or equipment:

The Customer must as soon as reasonably practicable following written notice by **Transpower**, provide to **Transpower**:

- (a) access to any records of the Customer's monitoring or testing of the performance of any Equipment carried out in accordance with clause 7.4; and
- (b) access to inspect any Equipment;

as **Transpower** requires (acting reasonably).

7.6 Status of Transpower approval:

Any approval by **Transpower** provided to the Customer does not relieve the Customer from its obligations to meet the requirements of this Connection Code.

8. PERFORMANCE REQUIREMENTS FOR SCADA

The Customer must ensure that the interface between its Equipment and the **grid** for the exchange of data provided by SCADA must comply with **Transpower's** policy for the same as published from time to time in consultation with **designated transmission customers**.

APPENDIX A: TRANSPOWER'S AGREEMENT TO NON-COMPLIANCE WITH THE CONNECTION CODE

1. APPLICATION AND SUPPORTING INFORMATION

The Customer may apply in writing to **Transpower** for **Transpower's** agreement authorising non-compliance with this Connection Code.

An application shall:

(a) Specify the non-compliance:

specify the clauses of the Connection Code for which **Transpower's** agreement to non-compliance is sought;

(b) Provide supporting information:

provide information in support of the application with reasonable particularity (including information as to the capability of the non-compliant Equipment);

(c) Describe any remedial action to be undertaken:

describe any remedial action to be undertaken to ensure compliance with this Connection Code;

(d) Specify required term:

specify the term of the agreement which is sought; and

(e) Identify confidential information:

identify any information for which confidentiality is sought on the ground that it would, if disclosed, unreasonably prejudice the commercial position of the Customer (or other person who is the subject of the information) or on the ground that it is information that is subject to an obligation of confidence, and the period for which confidentiality is sought.

2. TRANSPOWER OBLIGATIONS ON RECEIPT OF APPLICATION

Within 5 business days of receipt of the application made under clause 1 of this appendix, **Transpower** must provide the Customer with an estimate of the time it will take to consider the application and the costs associated with processing the application:

3. RIGHTS AND OBLIGATIONS DURING THE PROCESSING OF APPLICATIONS

(a) Reasonable endeavours:

Transpower will use reasonable endeavours to consider and decide whether or not to agree to the application within the estimated time and costs provided in accordance with clause 2 of this appendix.

(b) **Transpower to act reasonably:**

Transpower will act reasonably in deciding whether or not to enter into an agreement under this Appendix A, and in determining the terms and conditions on which it is prepared to enter into an agreement.

(c) **Additional information:**

Transpower may require the Customer to provide information in support of the application and the Customer shall provide the same in order for the application to be considered.

(d) **Withdrawal of application:**

If the Customer withdraws an application, it must on demand pay the actual and reasonable costs incurred by **Transpower** up to and including the date of withdrawal of the application in considering the application.

4. **OBLIGATION OF THE CUSTOMER TO PAY COSTS**

The Customer must on demand pay **Transpower's** actual and reasonable costs incurred in considering an application under this appendix.

5. **AGREEMENT**

Transpower will notify the Customer of the outcome of any application by it for **Transpower's** agreement to non-compliance with this Connection Code but if the application is granted there shall be no legally binding agreement between **Transpower** and the Customer unless and until they enter into a formal and final supplementary written agreement signed by each of them, which is expressed to be legally binding as between them. Such an agreement shall be supplementary to and form part of the Agreement.

APPENDIX B. VOLTAGE AND FAULT LEVELS

Table B1: Maximum and Minimum Voltage Limits

Nominal Voltage (kV)	Maximum System Voltage (kV)	Minimum System Voltage (kV)
220	242	198
110	121	99
66	69.3	62.7
50	52.5	47.5
33	36	30
22	24	20
11	12	10

Table B2: Maximum Short-Circuit Power and Current Limits

Nominal voltage (kV)	Maximum short-circuit power and current limits	
	(MVA)	(kA)
220	12,000	31.5*
110	6,000	31.5*
66	1,800	16*
50	1,350	16
33	1,400	25
22	950	25
11	475	25

* The values shown are the default existing fault maximum levels. At some sites the levels already exceed the levels shown and the number of sites that exceed the default levels will increase in the future. Ten year forecast maximum figures will be published annually.

Table B3: Voltage Levels for Insulation Co-ordination

Nominal voltage (kV)	Highest voltage for Equipment (kV)	Rated insulation level (kV)	Rated short duration (1 minute) power frequency withstand voltage (kV)
220	245	950	395
110	123	550	230
66	72.5	325	140
50	55	250	95
33	36	170	70
22	24	125	50
11	12	75	28

Table B4: Fault Clearance Times

Nominal Voltage (kV)	Design fault clearance time (ms)	Final fault clearance time (s)
220	120	4n
110	200	3
66	200	3
50	200	3
33*	200	3
22*	200	3
11*	200	3
33u	1000	3
22u	1000	3
11u	1000	3

- * Only bus and LV Transformer zone, not feeders
- u For close in high impedance feeder faults
- n The figure for 220 kV is higher than those below because of the grading required with protection at lower voltages

Electricity Industry Participation Code 2010

Part 12A Distributor agreements, arrangements, and other provisions

Part 12A (other than clauses 12A.5B to 12A.5E): replaced, on 20 July 2020, by clause 7 of the Electricity Industry Participation Code Amendment (Default Distributor Agreement) 2020.

Part 12A Heading: amended, on 1 April 2023, by clause 5 of the Electricity Industry Participation Code Amendment (Settlement Residual Allocation Methodology) 2022.

Contents

12A.1	Contents of this Part
12A.2	Participants to which the schedules to this Part apply
12A.3	Distributors must pass-through settlement residue
12A.5B	<i>[Revoked]</i>
12A.5C	<i>[Revoked]</i>
12A.5D	<i>[Revoked]</i>
12A.5E	<i>[Revoked]</i>

Schedule 12A.1

Requirements for entering into distributor agreements

Appendix A: Default agreement – Distributions on behalf of distributor

Appendix B: Default agreement – Provision of trust and co-operative company information

Appendix C: Default agreement – Provision of consumption data

Schedule 12A.2

Other provisions applying to distributor and participant arrangements

Schedule 12A.3

Requirements for distributors and traders on embedded networks (interposed)

Schedule 12A.4

Requirements for developing, making available, and amending default distributor agreements

Appendix A: Default distributor agreement for distributors and traders on local networks (interposed)

12A.1 Contents of this Part

This Part—

- (a) specifies requirements with which each **local network distributor** and each **trader** trading on the **distributor's network** must comply when entering into a **distributor agreement**; and
- (b) specifies other requirements that apply to each **distributor** that has an **interposed arrangement** with 1 or more **traders**, and each **trader** trading on the **distributor's network**; and

- (c) requires each **local network distributor** that has an **interposed arrangement** with 1 or more **traders** to develop and publish a **default distributor agreement** based on the relevant **default distributor agreement template**; and
- (d) contains other provisions related to **distributors**.

Clause 12A.1(c): amended, on 1 April 2023, by clause 6(1) of the Electricity Industry Participation Code Amendment (Settlement Residual Allocation Methodology) 2022.

Clause 12A.1(d): inserted, on 1 April 2023, by clause 6(2) of the Electricity Industry Participation Code Amendment (Settlement Residual Allocation Methodology) 2022.

12A.2 Participants to which the schedules to this Part apply

- (1) Each **distributor** described in a row in column 1 below, and each **participant** described in column 2 of the row, must comply with the provisions set out in each schedule referred to in column 3 of the row:

Row	Column 1 – Distributor	Column 2 – Participant	Column 3 – Schedule
1	Each distributor that owns or operates a local network , and has an interposed arrangement with 1 or more traders trading on the local network	Each trader that is a retailer , and is trading or wishes to trade at an ICP on the network of a distributor described in column 1 of this row	Schedule 12A.1 Schedule 12A.2 Schedule 12A.4
2	Each distributor that owns or operates an embedded network , and has an interposed arrangement with 1 or more traders trading on the embedded network	Each trader that is a retailer , and is trading or wishes to trade at an ICP on the network of a distributor described in column 1 of this row	Schedule 12A.2 Schedule 12A.3

- (2) The schedules to this Part also specify requirements for appeals to the **Rulings Panel**.
Clause 12A.2 Heading: amended, on 1 April 2023, by clause 7 of the Electricity Industry Participation Code Amendment (Settlement Residual Allocation Methodology) 2022.

12A.3 Distributors must pass-through settlement residue

- (1) The purpose of this clause is to allocate **settlement residue** to customers in proportion to the transmission charges paid by those customers in respect of each **connection location**.
- (2) A **distributor** that is paid any amount of **settlement residue** under clause 14.35A(1) of Part 14 must, on a monthly basis, allocate and pay this amount to its customers that pay **lines** charges directly to the **distributor** (“distribution customers”) in accordance with a methodology developed under subclause (3).
- (3) Each **distributor** to whom subclause (2) applies must develop a methodology for allocating **settlement residue** to its distribution customers that gives effect to the purpose described in subclause (1) and reflects the information provided to the **distributor** by **Transpower** under clause 14.35A(6) of Part 14.
- (4) A **distributor** must publish the methodology developed under subclause (3), including an explanation of the rationale for the methodology.
- (5) A **distributor** must publish annually a breakdown of payments made under subclause (2) by **connection location** and type of distribution customer (for example retailer, direct generation customer, direct load customer).

- (6) From time to time the **Authority** may prescribe the form that the annual breakdown of payments must take when **distributors** publish this breakdown of payments under subclause (5).
- (7) A **distributor** may adjust any payment made under subclause (2) to correct for a previous overpayment or underpayment under that subclause or to adjust for any amount of negative **settlement residue** or **settlement residue** processing costs the **distributor** is charged by a **grid owner**.
- (8) A payment required under subclause (2) may be met by way of a credit against any amount owed to the **distributor** by the customer.
- (9) This clause applies to **settlement residue** paid to a **grid owner** in respect of any **trading period** on or after 1 April 2023.

Clause 12A.3: inserted, on 1 April 2023, by clause 8 of the Electricity Industry Participation Code Amendment (Settlement Residual Allocation Methodology) 2022.

Clause 12A.3(7): amended, on 1 October 2023, by clause 38 of the Electricity Industry Participation Code Amendment (Default Transmission Agreement) 2023.

12A.5B [Revoked]

Clause 12A.5B: inserted, on 20 May 2020, by clause 4 of the Electricity Industry Participation Code Amendment (COVID-19 Deferred Payment of Distribution Charges) 2020.

Clause 12A.5B: revoked, on 18 November 2020, by clause 4 of the Electricity Industry Participation Code Amendment (Revocation of COVID-19 Deferred Payment of Distribution Charges) 2020.

12A.5C [Revoked]

Clause 12A.5C: inserted, on 20 May 2020, by clause 4 of the Electricity Industry Participation Code Amendment (COVID-19 Deferred Payment of Distribution Charges) 2020.

Clause 12A.5C: revoked, on 18 November 2020, by clause 4 of the Electricity Industry Participation Code Amendment (Revocation of COVID-19 Deferred Payment of Distribution Charges) 2020.

12A.5D [Revoked]

Clause 12A.5D: inserted, on 20 May 2020, by clause 4 of the Electricity Industry Participation Code Amendment (COVID-19 Deferred Payment of Distribution Charges) 2020.

Clause 12A.5D: revoked, on 18 November 2020, by clause 4 of the Electricity Industry Participation Code Amendment (Revocation of COVID-19 Deferred Payment of Distribution Charges) 2020.

12A.5E [Revoked]

Clause 12A.5E: inserted, on 20 May 2020, by clause 4 of the Electricity Industry Participation Code Amendment (COVID-19 Deferred Payment of Distribution Charges) 2020.

Clause 12A.5E: revoked, on 18 November 2020, by clause 4 of the Electricity Industry Participation Code Amendment (Revocation of COVID-19 Deferred Payment of Distribution Charges) 2020.

Schedule 12A.1

cl 12A.2(1)

Requirements for entering into distributor agreements

1 Content of this Schedule

This Schedule sets out provisions that apply to each **distributor** described in a row in column 1 below, and each **participant** described in column 2 of the row:

Row	Column 1 – Distributor	Column 2 – Participant
1	Each distributor that owns or operates a local network , and has an interposed arrangement with 1 or more traders trading on the local network	Each trader that is a retailer , and is trading or wishes to trade at an ICP on the network of a distributor described in column 1 of this row

2 Obligation to have a distributor agreement

- (1) A person that wishes to be a **participant** that trades on, is connected to, or uses a **distributor's network** or equipment connected to a **distributor's network** must have a **distributor agreement** with the **distributor**.
- (2) The person must ensure that the **distributor agreement** comes into force on or before the day on which the person commences trading on or using, or is connected to or using equipment connected to, the **distributor's network**.

3 Notice of intention to trade on, be connected to, or use a network

- (1) A person described in clause 2(1) must give notice to the **distributor** that it wishes to trade on, be connected to, or use the **distributor's network** or equipment connected to the **distributor's network** as a **participant** at least 20 **business days** before the person proposes to do so.
- (2) The person may withdraw the notice at any time before it enters into, or is deemed to have entered into, a binding contract with the **distributor** under clause 6, by giving notice of the withdrawal of the notice to the **distributor**.

Negotiating, and entering into, distributor agreements

4 Clauses that apply if distributor has published default distributor agreement

Clauses 5 to 9 apply if a **distributor** receives a notice from a person under clause 3(1) after the **distributor** has made the relevant **default distributor agreement** available on its website under clause 6(1) of Schedule 12A.4.

5 Distributor must offer to contract

The **distributor** must offer to contract with the person that gives notice under clause 3(1) on the terms set out in the **default distributor agreement** no later than 5 **business days** after receiving the notice.

6 When default distributor agreement applies as a binding contract

- (1) At any time before the relevant **default distributor agreement** applies as a binding contract between the **distributor** and the person who gave notice under clause 3(1), either the **distributor** or the person may give the other party notice that it wishes to contract with the other party on the terms set out in the **default distributor agreement**.
- (2) If either party gives a notice under subclause (1), the **default distributor agreement** applies as a binding contract between the parties with effect from—
 - (a) the later of—
 - (i) the 5th **business day** after the date on which the notice is given; or
 - (ii) the day on which the person becomes a **participant**; or
 - (b) any other date agreed by the parties.
- (3) If, at the expiry of 20 **business days** after a notice is received by a **distributor** under clause 3(1), or any other date agreed by the parties, the parties have not agreed on the terms of a **distributor agreement** and neither party has given a notice under subclause (1), the **default distributor agreement** applies as a binding contract (being a **distributor agreement**) between the parties with effect from—
 - (a) the later of—
 - (i) the expiry of the 20 **business day** period; or
 - (ii) the day on which the person becomes a **participant**; or
 - (b) any other date agreed by the parties.
- (4) At any time before the relevant **default distributor agreement** applies as a binding contract between the parties, the person who gave notice under clause 3(1) may give the **distributor** notice that it does not agree to the inclusion of one or more **collateral terms** in the **default distributor agreement** published in accordance with clause 6(1) or 12(1) of Schedule 12A.4.
- (5) For the purposes of this clause, a **distributor agreement** that applies as a binding contract between the parties includes—
 - (a) all **core terms**, **operational terms**, and **recorded terms** (if any) included in the **default distributor agreement** published in accordance with clause 6(1) or 12(1) of Schedule 12A.4; and
 - (b) all **recorded terms** otherwise notified by the **distributor** to the other party; and
 - (c) subject to subclause (6), all **collateral terms** included in the **default distributor agreement** published in accordance with clause 6(1) or 12(1) of Schedule 12A.4; and
 - (d) any terms relating to additional services that either party requires be entered into in accordance with clause 7 (including any alternative terms agreed in accordance with clauses 7(4) and 9).
- (6) A **distributor agreement** that applies as a binding contract under subclause (5) does not include any **collateral term** to which a notice given under subclause (4) applies.

Additional services

7 Terms relating to additional services

- (1) This clause applies if a **distributor** receives a notice from a person under clause 3(1) that the person wishes to trade on, be connected to, or use the **distributor's network** or equipment connected to the **distributor's network** as a **participant**.

- (2) A **participant** described in a row in column 1 below may, by notice to the other party to a **distributor agreement** or proposed **distributor agreement**, require that an agreement on the terms set out in the appendix described in column 2 of the row be entered into between the parties:

Row	Column 1 – Participant that may elect additional services	Column 2 – Appendix
1	Distributor	Appendix A (Default agreement – Distributions on behalf of distributor)
2	Distributor	Appendix B (Default agreement – Provision of trust and co-operative company information)
3	Distributor or trader	Appendix C (Default agreement – Provision of consumption data)

- (3) Subject to subclause (4), if a party gives notice under subclause (2), the terms in the appendix that is the subject of the notice apply as a binding contract between the parties with effect from—
- the 5th **business day** after the date on which the notice is given; or
 - any other date agreed by the parties
- (4) A **distributor** and a **participant** may agree to alternative terms relating to additional services in accordance with clause 9.
- (5) To avoid doubt, a **participant** may give notice under subclause (2) after the commencement of the **distributor agreement**.

Alternative agreements and alternative terms for additional services

8 Alternative agreements

- (1) A **distributor** and a **participant** may enter into an agreement on terms that differ from the terms set out in the relevant **default distributor agreement** (an "**alternative agreement**").
- (2) A **distributor agreement** that differs from the relevant **default distributor agreement** only because one or more **collateral terms** in the **default distributor agreement** has been omitted is not an **alternative agreement** for the purposes of this Part.
- (3) If a **distributor** and a **participant** enter into an **alternative agreement** under this clause, the **distributor** and **participant** must ensure that the **alternative agreement** does not include any term that is inconsistent with, or modifies the effect of, any term that applies under clause 7(3).
- (4) To avoid doubt,—
 - an **alternative agreement** is a **distributor agreement** for the purposes of this Code; and
 - parties to an existing **distributor agreement** based on the **default distributor agreement** may agree to enter into an **alternative agreement** to replace the existing **distributor agreement**.

9 Alternative terms for additional services

- (1) A **distributor** and a **participant** may agree to terms that address the subject-matter of an appendix described in clause 7(2) (“alternative terms for an additional service”).
- (2) If a **distributor** and a **participant** agree to alternative terms for an additional service, the **distributor** and **participant** must ensure that none of those terms are inconsistent with, or modify the effect of—
 - (a) **core terms** in the relevant **default distributor agreement** and **default distributor agreement template**; or
 - (b) **operational terms** in the relevant **default distributor agreement**.
- (3) The alternative terms for an additional service apply from the date agreed between the parties.

Other agreements

10 Other agreements and arrangements

Nothing in this Part prevents a **distributor** and a **participant** from entering into any other agreement or arrangement, provided that the terms of the other agreement or arrangement—

- (a) do not address the subject-matter of the terms of a **default distributor agreement**; and
- (b) do not relate to the service or services described in a **default distributor agreement**; and
- (c) are not inconsistent with, and do not modify the effect of, any **default distributor agreement** or **alternative agreement**.

Providing distributor agreements to the Authority

11 Participants must provide distributor agreements to Authority

- (1) A **participant** who enters into a **distributor agreement** with a **distributor** in accordance with clause 6 or clause 8 must give the **Authority** a copy of—
 - (a) the **distributor agreement**, no later than 10 **business days** after the agreement becomes a binding contract; and
 - (b) any variation to the **distributor agreement**, no later than 10 **business days** after the variation is agreed; and
 - (c) any other agreement that the **participant** enters into with the **distributor** at any time during the period commencing on the date on which the **participant** gives the **distributor** notice under clause 3(1) and ending on the date on which the **participant** and the **distributor** enter into a **distributor agreement**, no later than 10 **business days** after the **distributor agreement** becomes a binding contract.
- (2) To avoid doubt, a **distributor agreement** includes, for the purpose of this clause—
 - (a) all **core terms**, **operational terms**, and **recorded terms**; and
 - (b) all terms relating to additional services applied or agreed in accordance with clause 7 or clause 9; and
 - (c) all other terms included in the same agreement as **core terms**, **operational terms**, and **recorded terms**, including **collateral terms**; and

- (d) an **alternative agreement** entered into in accordance with clause 8, including all terms for additional services applied or agreed in accordance with clause 7 or clause 9 and any other terms included in the **alternative agreement**.
- (3) The **Authority** may **publish** any **distributor agreement** or other agreement given to it under subclause (1).

Transitional provisions for parties with existing agreements

12 Transitional provisions for existing agreements

- (1) This clause applies to a **distributor** and a **participant** that entered into an agreement for services that commenced before the date on which the **distributor** made a **default distributor agreement**, that applies in respect of the arrangement between the **distributor** and the **participant**, available on its website under clause 6(1) of Schedule 12A.4 ("existing agreement").
- (2) The **distributor** must, no later than 10 **business days** after the date on which the **distributor** makes its **default distributor agreement** available on its website, offer to contract with the **participant** on the terms set out in the **default distributor agreement**.
- (3) At any time before the **default distributor agreement** applies as a binding contract between the **distributor** and the **participant** under subclause (5), either the **participant** or the **distributor** may give the other party notice that the **participant** or **distributor** wishes to contract with the other party on the terms set out in the **default distributor agreement**.
- (4) If either party gives a notice under subclause (3), the relevant **default distributor agreement** applies as a binding contract between the **distributor** and the **participant** with effect from the 10th **business day** after the date on which the notice is given, or any other date agreed by the parties.
- (5) Subject to subclause (4), if the **distributor** and the **participant** have not agreed on the terms of a **distributor agreement** to replace the existing agreement at the expiry of 3 months after the date on which the **distributor** makes its **default distributor agreement** available on its website, or any other date agreed by the parties,—
 - (a) the relevant **default distributor agreement** applies as a binding contract (being a **distributor agreement**) between the **distributor** and the **participant** with effect from the expiry of that period, and clause 6(5) applies (with all necessary modifications) in respect of the **distributor agreement**; and
 - (b) the provisions of the existing agreement that directly or indirectly relate to the services described in the relevant **default distributor agreement**, or any additional services described in an appendix to this Schedule, are deemed to have been terminated with effect from that date.
- (6) Clause 6(4) to (6) apply to a **distributor** and a **participant** to which this clause applies as if the **participant** had given a notice under clause 3(1) and the **distributor** is the **distributor** to whom the notice was given.
- (7) Clause 8, which relates to **alternative agreements**, applies if the parties wish to replace an existing agreement with an **alternative agreement**.
- (8) Clause 9, which relates to alternative terms for additional services, applies if the parties wish to agree to alternative terms for an additional service.

Schedule 12A.1, Appendix A Sch 12A.1, cl 7(2)
Default agreement – Distributions on behalf of distributor

AGREEMENT dated 20[]

PARTIES

Distributor: [insert full legal name of the Distributor]	Trader: [insert full legal name of the Trader]
<p>Distributor's Details:</p> <p>Street Address: [insert]</p> <p>Postal Address: [insert]</p> <p>Address for Notices: [insert]</p> <p>Contact Person's Details:</p> <p>Phone: [insert]</p> <p>Fax: [insert]</p> <p>Website: [insert]</p> <p>Email Address: [insert]</p>	<p>Trader's Details:</p> <p>Street Address: [insert]</p> <p>Postal Address: [insert]</p> <p>Address for Notices: [insert]</p> <p>Contact Person's Details:</p> <p>Phone: [insert]</p> <p>Fax: [insert]</p> <p>Website: [insert]</p> <p>Email Address: [insert]</p>

COMMENCEMENT DATE

[insert date]

SIGNATURES

[Parties can sign the Agreement using the signature block below, but see clause 7 of Schedule 12A.1 of the Code, which provides for the Agreement to apply as a binding contract in certain circumstances]

Signature	Signature
Name of authorised person signing for Distributor	Name of authorised person signing for Trader
Position	Position
Date	Date

INTRODUCTION

- A. The Distributor and Trader are parties to a Distributor Agreement, and have agreed to enter into this agreement for additional services relating to distributions on behalf of the Distributor in accordance with a notice given by the Distributor under clause 7 of Schedule 12A.1 of the Code.

TERMS

1 Distributor can require the Trader to pass on distributions

- (1) The Distributor [has a Shareholder Trust as a shareholder/is a Co-operative] and requires the Trader from time to time to distribute [income/payments or credits on behalf of the Distributor] to [the Shareholder Trust's beneficiaries/its shareholders].
- (2) The Distributor may require that the Trader pay distributions on behalf of the [Shareholder Trust/Distributor] to each of the Trader's qualifying Customers by crediting each qualifying Customer's electricity account ("[Monetary Distribution Services or equivalent]"), by giving the Trader at least 40 Working Days' notice of the requirement in accordance with clause 2.
- (3) The Distributor may not require the Trader to pay distributions under subclause (2) any more frequently than necessary to ensure that distributions are credited to Customers on or by any date that the [Shareholder Trust/Distributor] resolves to distribute [income/payments or credits] to its [beneficiaries/shareholders].
- (4) If the Distributor has given notice to the Trader to pay [income/monetary] distributions under any use-of-system agreement or equivalent agreement entered into prior to the date of this Agreement coming into effect, the Distributor may, by notice to the Trader within 5 Working Days of this Agreement coming into effect, elect that the [income/monetary] distribution services terms of the prior agreement apply to the distributions that have already been notified.

2 Distributor notice of requirements for distributions on behalf of Distributor

- (1) A notice given by a Distributor under clause 1 must include the following:
 - (a) the time period within which the [Shareholder Trust/Distributor] has set the eligibility date for Customers to be qualifying Customers;
 - (b) a description of the information the [Shareholder Trust/Distributor] requires to identify qualifying Customers, including any exclusions;
 - (c) the ICPs on the Network in respect of which a distribution is payable;
 - (d) a description of the information the [Shareholder Trust/Distributor] requires to calculate the distributions payable;
 - (e) the proposed process and timelines for information to be exchanged between the parties to enable efficient implementation;
 - (f) contact details of persons who can be contacted in respect of Customer queries that cannot be addressed by the Trader;
 - (g) expected frequently asked questions by Customers and the answers to those questions;
 - (h) the format in which Customer information is to be exchanged in accordance with clause 6;

- (i) whether the Distributor[, on behalf of the Shareholder Trust,] requires any other information in respect of each qualifying Customer for the purposes set out in clause 9(3); and
 - (j) whether the Distributor[, on behalf of the Shareholder Trust,] requires information under clause 6(b).
- (2) The Trader must, acting reasonably and within 5 Working Days of receiving a notice under clause 1, advise the Distributor if the Trader is unable to meet any of the requirements set out in the notice, and the reasons for that.
 - (3) The Distributor must, as soon as practicable after giving notice under clause 1 and by no later than 10 Working Days before posting or publishing the relevant material, provide the Trader with:
 - (a) a draft of any promotional material relating to the distributions that the Distributor wants the Trader to include with the invoice that records the credit given in respect of any distribution paid; and
 - (b) a draft of any proposed publicity information relating to the distributions, including media releases.

3 Payment of Trader's reasonable costs

- (1) The Distributor must pay the Trader's reasonable costs incurred in providing any Monetary Distribution Services that the Distributor requests in a notice given under clause 1.
- (2) If requested by the Distributor, the Trader must give the Distributor a quote for providing the Monetary Distribution Services before the Trader provides those services.
- (3) The Distributor must pay the Trader's GST invoice for the Monetary Distribution Services no later than the 20th of the month following the invoice date.

4 File with Customer information

- (1) The Distributor may request from the Trader any information that the Distributor reasonably requires to enable it to identify qualifying Customers and to calculate the distribution payable to each qualifying Customer.
- (2) The Trader must provide a file to the Distributor containing any information reasonably requested by the Distributor under subclause (1) no later than 10 Working Days after the Distributor's request.
- (3) The Distributor must, as soon as practicable after receipt of all Traders' files:
 - (a) return the file provided under subclause (2) to the Trader with information identifying qualifying Customers and the distribution amounts payable to each qualifying Customer; and
 - (b) notify the Trader whether [the Distributor or the Shareholder Trust will pay the total amount of such distributions to the Trader and whether] a GST invoice is required.
- (4) If there are any changes to the type of information to be exchanged, or changes to the eligibility criteria compared with the criteria that applied to the last distribution passed on by the Trader, the parties must test the information exchange process in advance.

5 Distributing payments or credits to qualifying Customers

- (1) The Trader must, as soon as practicable after receiving payment of the total amount of the distributions from the Distributor [or the Shareholder Trust as notified under clause 4(3)]:
 - (a) credit the distribution amount determined by the Distributor and included in the file in accordance with clause 4(3) to each qualifying Customer's account; and

- (b) provide the Distributor with a file that includes the information set out in clause 6.
- (2) The Trader must, if its billing systems allow it to do so, ensure that the distribution is separately identified on each qualifying Customer's invoice, with the words “[Distributor Name/Name of Shareholder Trust] distribution” (or any similar words as advised by the Distributor).
- (3) If applicable, the Trader must provide the Distributor’s promotional material relating to the distribution to the Customer along with the Trader’s invoice that includes the distribution.

6 File with information about distributions paid on by the Trader

The Trader must, as soon as practicable after paying distributions in accordance with clause 5, provide the Distributor with a file containing the following information:

- (a) in respect of each qualifying Customer to whom the Trader paid a distribution:
 - (i) the ICP identifier;
 - (ii) the amount of the distribution paid;
 - (iii) the Customer's name;
 - (iv) the Customer's physical or residential address (if available); and
 - (v) any other information specified by the Distributor under clause 2(1)(i); and
- (b) if the Distributor has specified under clause 2(1)(j) that it requires that information, in respect of each qualifying Customer to whom a distribution was not fully paid:
 - (i) the ICP identifier;
 - (ii) the amount of the distribution not paid;
 - (iii) the Customer's name; and
 - (iv) the Customer's physical or residential address (if available).

7 Confidentiality obligations

- (1) Subject to subclause (2), the Distributor undertakes that, in respect of any information provided to it by the Trader under clause 4 or clause 6 (“Confidential Customer Information”), the Distributor will:
 - (a) preserve the confidentiality of, and will not directly or indirectly reveal, report, publish, transfer, or disclose the Confidential Customer Information except as expressly permitted in this Agreement;
 - (b) only use the Confidential Customer Information for a purpose expressly permitted in this Agreement; and
 - (c) only disclose the Confidential Customer Information for a purpose expressly permitted in this Agreement and on a ‘need to know’ basis.
- (2) For the purposes of this Agreement:
 - (a) the Distributor may disclose Confidential Customer Information if it is required to disclose the Confidential Customer Information by:
 - (i) law, or by any statutory or regulatory body or authority; or
 - (ii) any judicial or other arbitration process; and
 - (b) Confidential Customer Information does not include aggregated and anonymised information.
- (3) The Distributor’s liability for breach of this clause is not limited by any terms in this Agreement or in any other agreement between the parties.
- (4) To avoid doubt, the Distributor is responsible for any unauthorised disclosure of Confidential Customer Information made by the Distributor's employees, contractors, directors, agents, or advisors.

8 Payment of distribution amounts

- (1) If notice is given under clause 4(3) that a GST invoice is required, the Trader must issue the Distributor [or the Shareholder Trust] with a GST invoice in accordance with that notice for the total amount of distributions credited, or to be credited, to qualifying Customers under clause 5.
- (2) The Distributor [(unless it nominates the Shareholder Trust in its notice given under clause 4(3), in which case the Shareholder Trust)] must deposit the total amount of such distributions, without offset, into the Trader's nominated bank account no later than 5 Working Days (or any alternative agreed date) after notice is given under clause 4(3) or, if a GST invoice is required, the Trader issues its GST invoice.
- (3) Any distribution payments received by the Trader from the Distributor [or Shareholder Trust] under this clause must be held by the Trader in an appropriate bank account as separately identifiable funds, on trust for the benefit of the Customers who are entitled to receive the distributions.
- (4) If, for any reason, the distribution payable to a qualifying Customer is unable to be paid by the Trader (by way of example but without limitation, because the person ceases to be a Customer and its account with the Trader has a credit balance after the date of processing of the distribution), and the Trader has received funds from the Distributor [or the Shareholder Trust] in respect of the distribution, the Trader must, as soon as practicable:
 - (a) refund to the Distributor [(unless the Trader received funds from the Shareholder Trust in respect of the distribution, in which case the Trader must refund to the Shareholder Trust)] the distribution received for the person, or the net credit of the account for the person if that is less than the amount of the distribution for the person; or
 - (b) refund the person directly the remaining amount.

9 Permitted additional use and disclosure of Confidential Customer Information

- (1) The Distributor may use Confidential Customer Information to:
 - (a) assess whether the Distributor is Consumer-Owned; and
 - (b) comply with any obligations under the Commerce Act 1986 regarding whether the Distributor meets the criteria to be a Consumer-Owned supplier.
- (2) To avoid doubt, the Distributor may disclose Confidential Customer Information to the Commerce Commission, including in circumstances where the Commerce Commission has not exercised a power under the Commerce Act 1986 to require the Distributor to disclose Confidential Customer Information.
- (3) [The Distributor may disclose Confidential Customer Information provided by the Trader to the Shareholder Trust, but the Distributor must enter into arrangements with the Shareholder Trust to ensure that the Shareholder Trust only uses the/The Distributor may use] Confidential Customer Information for the purposes of:
 - (a) ensuring that [income is/payments or credits are] distributed to [beneficiaries/shareholders] in accordance with the [Shareholder Trust's/Distributor's] requirements; and
 - (b) enabling a third party to carry out audits of the Distributor [or the Shareholder Trust].
- (4) In the case of Confidential Customer Information disclosed to a Shareholder Trust:
 - (a) the Distributor may enter into arrangements with the Shareholder Trust that allow the Shareholder Trust to disclose Confidential Customer Information if required by:
 - (i) law, or by any statutory or regulatory body or authority; or

- (ii) any judicial or other arbitration process; and
- (b) the Distributor is responsible for any unauthorised disclosure of Confidential Customer Information made by the Shareholder Trust, or by the Shareholder Trust's employees, contractors, directors, agents, or advisors.

10 Distributor indemnity

- (1) The Distributor indemnifies the Trader against any costs, losses, liabilities, claims, charges, demands, expenses, or actions incurred by the Trader, or made against the Trader, as a result of, or in relation to, any illegal, defamatory, or offensive content in the Distributor's promotional material, except to the extent that such costs, losses, liabilities, claims, charges, demands, expenses, or actions arise as a result of, or in connection with, any breach by the Trader of its obligations under this Agreement.
- (2) This clause applies despite any other provisions in this Agreement or in any other agreement between the parties.
- (3) In the event of a claim against the Trader in relation to which the Trader wishes (at the time of the claim or later) to be indemnified by the Distributor under subclause (1) (a "promotional material claim"), the Trader must:
 - (a) give written notice of the promotional material claim to the Distributor as soon as practicable after the Trader determines that it wishes to be indemnified by the Distributor, specifying the nature of the claim in reasonable detail; and
 - (b) make available to the Distributor all information that the Trader holds in relation to the promotional material claim that is reasonably required by the Distributor.

11 Notices

- (1) Any notice given under this Agreement must be in writing and will be deemed to be validly given if personally delivered, posted, or sent by facsimile transmission or email to the address for notice set out in the Parties section of this Agreement or to such other address as that party may notify from time to time.
- (2) Any notice given under this Agreement will be deemed to have been received:
 - (a) in the case of personal delivery, when delivered;
 - (b) in the case of facsimile transmission, when sent, provided that the sender has a facsimile confirmation receipt recording successful transmission;
 - (c) in the case of posting, 3 Working Days following the date of posting; and
 - (d) in the case of email, when actually received in readable form by the recipient, provided that a delivery failure notice has not been received by the sender, in which case the notice will be deemed not to have been sent.
- (3) Any notice given in accordance with subclause (2) that is personally delivered or sent by facsimile or email after 5pm on a Working Day or on any day that is not a Working Day will be deemed to have been received on the next Working Day.

12 Definitions

In this Agreement:

"**Agreement**" means this agreement relating to distributions on behalf of the Distributor;

"**Code**" means the Electricity Industry Participation Code 2010 made under the Electricity Industry Act 2010;

"**Confidential Customer Information**" has the meaning set out in clause 7(1);

"Consumer-Owned" has the meaning given to it in section 54D of the Commerce Act 1986;

"Co-operative" means a co-operative company under the Co-operative Companies Act 1996 in respect of which any of the shareholders to whom distributions are paid comprise persons who are of a class or classes identified by reference to any of:

- (a) the person's connection to the Network;
- (b) the person's receipt of electricity from the Distributor;
- (c) the person's liability for payment for supply of electricity from the Distributor;
- (d) the person's liability for payment for the connection to the Network; or
- (e) the person's liability for payment for Distribution Services supplied by the Distributor;

"Customer" means a person who purchases electricity from the Trader that is delivered via the Network;

"Customer's Installation" means an Electrical Installation and includes Distributed Generation, if Distributed Generation is connected to a Customer's Installation;

"De-energise" means the operation of any isolator, circuit breaker, or switch or the removal of any fuse or link so that no electricity can flow through a Point of Connection on the Network;

"Distributed Generation" means generating plant equipment collectively used for generating electricity that is connected, or proposed to be connected, to the Network or a Customer's Installation, but does not include:

- (a) generating plant connected to the Network and operated by the Distributor for the purpose of maintaining or restoring the provision of electricity to part or all of the Network:
 - (i) as a result of a Planned Service Interruption; or
 - (ii) as a result of an Unplanned Service Interruption; or
 - (iii) during a period when the Network capacity would otherwise be exceeded on part or all of the Network; or
- (b) generating plant that is only momentarily synchronised with the Network for the purpose of switching operations to start or stop the generating plant;

"Distribution Services" means the service of distribution, as defined in section 5 of the Electricity Industry Act 2010;

"Distributor" means the party identified as such in this Agreement;

"Distributor Agreement" means a distributor agreement as defined in the Code;

"Electrical Installation" means:

- (a) all Fittings that form part of a system for conveying electricity at any point from the Customer's Point of Connection to any point from which electricity conveyed through that system may be consumed; and
- (b) includes any Fittings that are used, or designed or intended for use, by any person, in or in connection with the generation of electricity for that person's use and not for supply to any other person; but
- (c) does not include any appliance that uses, or is designed or intended to use, electricity, whether or not it also uses, or is designed or intended to use, any other form of energy;

"Fitting" means everything used, designed, or intended for use, in or in connection with the generation, conversion, transformation, conveyance, or use of electricity;

"Grid" means the system of transmission lines, substations and other works, including the HVDC link used to connect grid injection points and GXPs to convey electricity throughout the North Island and the South Island of New Zealand;

"GST" means goods and services tax payable under the GST Act;

"GST Act" means the Goods and Services Tax Act 1985;

"GXP" means any Point of Connection on the Grid:

- (a) at which electricity predominantly flows out of the Grid; or
- (b) determined as being such in accordance with the Code;

"ICP" means an installation control point being 1 of the following:

- (a) a Point of Connection at which a Customer's Installation is connected to the Network;
- (b) a Point of Connection between the Network and an embedded network;
- (c) a Point of Connection between the Network and shared Unmetered Load

"Monetary Distribution Services" has the meaning set out in clause 1;

"Metering Equipment" means any apparatus for the purpose of measuring the quantity of electricity transported through an ICP along with associated communication facilities to enable the transfer of metering information;

"Network" means the Distributor's lines, substations and associated equipment used to convey electricity between:

- (a) 2 NSPs; or
- (b) an NSP and an ICP;

"Network Supply Point" or **"NSP"** means any Point of Connection between:

- (a) the Network and the Grid; or
- (b) the Network and another distribution network; or
- (c) the Network and an embedded network; or
- (d) the Network and Distributed Generation;

"Planned Service Interruption" means any Service Interruption that has been scheduled to occur in accordance with this Agreement;

"Point of Connection" means the point at which electricity may flow into or out of the Network;

"Service Interruption" means the cessation of electricity supply to an ICP for a period of 1 minute or longer, other than by reason of De-energisation of that ICP;

"Shareholder Trust" means a trust in respect of which any of the income beneficiaries comprise persons who are of a class or classes identified by reference to any of:

- (a) the person's connection to the Network;
- (b) the person's receipt of electricity from the Distributor;
- (c) the person's liability for payment for supply of electricity from the Distributor;
- (d) the person's liability for payment for the connection to the Network;
- (e) the person's liability for payment for Distribution Services supplied by the Distributor; or
- (f) the person's domicile or location or operation within the geographic area or areas of operation of the Distributor;

"Trader" means the party identified as such in this Agreement;

"Unmetered Load" means electricity consumed on the Network that is not directly recorded using Metering Equipment, but is calculated or estimated in accordance with the Code;

"Unplanned Service Interruption" means any Service Interruption where events or circumstances prevent the timely communication of prior warning or notice to the Trader or any affected Customer;

"Working Day" means every day except Saturdays, Sundays, and days that are statutory holidays in the city specified for each party's address for notices identified in the Parties section of this Agreement.

Sch 12A.1, cl 7(2)

Schedule 12A.1, Appendix B
Default agreement – Provision of trust and co-operative company information

AGREEMENT dated 20[]

PARTIES

Distributor: [insert full legal name of the Distributor]	Trader: [insert full legal name of the Trader]
Distributor's Details: Street Address: [insert] Postal Address: [insert] Address for Notices: [insert]	Trader's Details: Street Address: [insert] Postal Address: [insert] Address for Notices: [insert]
Contact Person's Details: Phone: [insert] Fax: [insert] Website: [insert] Email Address: [insert]	Contact Person's Details: Phone: [insert] Fax: [insert] Website: [insert] Email Address: [insert]

COMMENCEMENT DATE

[insert date]

SIGNATURES

[Parties can sign the Agreement using the signature block below, but see clause 7 of Schedule 12A.1 of the Code, which provides for the Agreement to apply as a binding contract in certain circumstances]

_____ Signature	_____ Signature
_____ Name of authorised person signing for Distributor	_____ Name of authorised person signing for Trader
_____ Position	_____ Position
_____ Date	_____ Date

INTRODUCTION

- A. The Distributor and Trader are parties to a Distributor Agreement, and have agreed to enter into this agreement for additional services relating to the provision of trust and co-operative company information in accordance with a notice given by the Distributor under clause 7 of Schedule 12A.1 of the Code.

TERMS

1 Background

The Distributor [has a Shareholder Trust as a shareholder/is a Co-operative] and requires, from time to time, information from the Trader to enable:

- (a) the [Shareholder Trust/Distributor] to update and maintain an accurate register of its [beneficiaries/shareholders], comply with its obligations to its [beneficiaries/shareholders], and directly communicate with those persons; and
- (b) the Distributor to assess whether it is Consumer-Owned, and comply with any obligations under the Commerce Act 1986 regarding whether the Distributor meets the criteria to be a Consumer-Owned supplier.

2 Provision of information

If reasonably requested by the Distributor, the Trader must provide, in a reasonable timeframe, relevant information in its possession required by the [Shareholder Trust/Distributor]:

- (a) to meet the [Shareholder Trust's/Distributor's] obligations under [its trust deed/the Co-operative Companies Act 1996];
- (b) for one of the permitted disclosures or uses set out in clause 3; or
- (c) for any other purpose as otherwise agreed in writing between the parties.

3 Permitted [disclosure/use] of information provided

- (1) The Distributor may use [and disclose to the Shareholder Trust] information provided in response to a request under clause 2 for the purposes of:
 - (a) [enabling the Shareholder Trust to update and maintain/updating and maintaining] an accurate register of its [beneficiaries/shareholders];
 - (b) [enabling the Shareholder Trust to conduct/conducting] elections of [trustees/members of the Distributor's committee of shareholders];
 - (c) [enabling the Shareholder Trust or the Distributor to pay/paying] distributions to the [Shareholder Trust's beneficiaries/the Distributor's shareholders or other parties that are entitled to distributions];
 - (d) enabling a third party to carry out audits of the Distributor [or the Shareholder Trust]; and
 - (e) [enabling the Shareholder Trust to ensure/ensuring] that the [Shareholder Trust/Distributor] complies with any other requirements under its [trust deed/constitution and the Co-operative Companies Act 1996].
- (2) The Distributor may use information provided in response to a request under clause 2 for the purposes of:
 - (a) assessing whether the Distributor is Consumer-Owned; and
 - (b) complying with any obligations under the Commerce Act 1986 regarding whether the Distributor meets the criteria to be a Consumer-Owned supplier.

4 Payment of Trader's reasonable costs

- (1) The Distributor must pay the Trader's reasonable costs incurred in supplying any information requested under clause 2.
- (2) If requested by the Distributor, the Trader must give the Distributor a quote for supplying the information before the Trader supplies the information.
- (3) The Distributor must pay the Trader's GST invoice for supplying the information no later than the 20th of the month following the invoice date.

5 Confidentiality obligations

- (1) Subject to subclause (2), the Distributor undertakes that, in respect of any information provided to it by the Trader under this Agreement ("Confidential Customer Information"), the Distributor will:
 - (a) preserve the confidentiality of, and will not directly or indirectly reveal, report, publish, transfer, or disclose any Confidential Customer Information except as expressly permitted in this Agreement;
 - (b) only use the Confidential Customer Information for a purpose expressly permitted in this Agreement;
 - (c) only disclose the Confidential Customer Information for a purpose expressly permitted in this Agreement and on a 'need to know' basis; and
 - (d) in the case of Confidential Customer Information disclosed to a Shareholder Trust, enter into arrangements with the Shareholder Trust to ensure that the Shareholder Trust:
 - (i) only uses the Confidential Customer Information for a purpose expressly permitted in this Agreement; and
 - (ii) only discloses the Confidential Customer Information for a purpose expressly permitted in this Agreement, or if the Shareholder Trust is required to disclose the Confidential Customer Information by law, by any statutory or regulatory body or authority, or by any judicial or other arbitration process.
- (2) For the purposes of this Agreement:
 - (a) the Distributor may disclose Confidential Customer Information if it is required to disclose the Confidential Customer Information by:
 - (i) law, or by any statutory or regulatory body or authority; or
 - (ii) any judicial or other arbitration process; and
 - (b) Confidential Customer Information does not include aggregated and anonymised information.
- (3) To avoid doubt, the Distributor may disclose Confidential Customer Information to the Commerce Commission, including in circumstances where the Commerce Commission has not exercised a power under the Commerce Act 1986 to require the Distributor to disclose Confidential Customer Information.
- (4) The Distributor's liability for breach of this clause is not limited by any terms in this Agreement or in any other agreement between the parties.
- (5) To avoid doubt, the Distributor is responsible for any unauthorised disclosure of Confidential Customer Information made by:
 - (a) the Distributor's employees, contractors, directors, agents, or advisors; and
 - (b) in the case of Confidential Customer Information that the Distributor has disclosed to the Shareholder Trust, the Shareholder Trust, or the Shareholder Trust's employees, contractors, directors, agents, or advisors.

6 Definitions

In this Agreement:

"**Agreement**" means this agreement for additional services relating to the provision of trust and co-operative company information;

"**Code**" means the Electricity Industry Participation Code 2010 made under the Electricity Industry Act 2010;

"**Confidential Customer Information**" has the meaning set out in clause 5(1);

"**Consumer-Owned**" has the meaning given to it in section 54D of the Commerce Act 1986;

"**Co-operative**" means a co-operative company under the Co-operative Companies Act 1996 in respect of which any of the shareholders to whom distributions are paid comprise persons who are of a class or classes identified by reference to any of:

- (a) the person's connection to the Network;
- (b) the person's receipt of electricity from the Distributor;
- (c) the person's liability for payment for supply of electricity from the Distributor;
- (d) the person's liability for payment for the connection to the Network; or
- (e) the person's liability for payment for Distribution Services supplied by the Distributor;

"**Customer**" means a person who purchases electricity from the Trader that is delivered via the Network;

"**Customer's Installation**" means an Electrical Installation and includes Distributed Generation, if Distributed Generation is connected to a Customer's Installation

"**De-energise**" means the operation of any isolator, circuit breaker, or switch or the removal of any fuse or link so that no electricity can flow through a Point of Connection on the Network;

"**Distributed Generation**" means generating plant equipment collectively used for generating electricity that is connected, or proposed to be connected, to the Network or a Customer's Installation, but does not include:

- (a) generating plant connected to the Network and operated by the Distributor for the purpose of maintaining or restoring the provision of electricity to part or all of the Network:
 - (i) as a result of a Planned Service Interruption; or
 - (ii) as a result of an Unplanned Service Interruption; or
 - (iii) during a period when the Network capacity would otherwise be exceeded on part or all of the Network; or
- (b) generating plant that is only momentarily synchronised with the Network for the purpose of switching operations to start or stop the generating plant;

"**Distribution Services**" means the service of distribution, as defined in section 5 of the Electricity Industry Act 2010;

"**Distributor**" means the party identified as such in this Agreement;

"**Distributor Agreement**" means a distributor agreement as defined in the Code;

"**Electrical Installation**" means:

- (a) all Fittings that form part of a system for conveying electricity at any point from the Customer's Point of Connection to any point from which electricity conveyed through that system may be consumed; and

- (b) includes any Fittings that are used, or designed or intended for use, by any person, in or in connection with the generation of electricity for that person's use and not for supply to any other person; but
- (c) does not include any appliance that uses, or is designed or intended to use, electricity, whether or not it also uses, or is designed or intended to use, any other form of energy;

"Fitting" means everything used, designed, or intended for use, in or in connection with the generation, conversion, transformation, conveyance, or use of electricity;

"Grid" means the system of transmission lines, substations and other works, including the HVDC link used to connect grid injection points and GXPs to convey electricity throughout the North Island and the South Island of New Zealand;

"GST" means goods and services tax payable under the GST Act;

"GST Act" means the Goods and Services Tax Act 1985;

"GXP" means any Point of Connection on the Grid:

- (a) at which electricity predominantly flows out of the Grid; or
- (b) determined as being such in accordance with the Code;

"ICP" means an installation control point being 1 of the following:

- (a) a Point of Connection at which a Customer's Installation is connected to the Network;
- (b) a Point of Connection between the Network and an embedded network;
- (c) a Point of Connection between the Network and shared Unmetered Load;

"Metering Equipment" means any apparatus for the purpose of measuring the quantity of electricity transported through an ICP along with associated communication facilities to enable the transfer of metering information;

"Network" means the Distributor's lines, substations and associated equipment used to convey electricity between:

- (a) 2 NSPs; or
- (b) an NSP and an ICP;

"Network Supply Point" or **"NSP"** means any Point of Connection between:

- (a) the Network and the Grid; or
- (b) the Network and another distribution network; or
- (c) the Network and an embedded network; or
- (d) the Network and Distributed Generation;

"Planned Service Interruption" means any Service Interruption that has been scheduled to occur in accordance with this Agreement;

"Point of Connection" means the point at which electricity may flow into or out of the Network;

"Service Interruption" means the cessation of electricity supply to an ICP for a period of 1 minute or longer, other than by reason of De-energisation of that ICP;

"Shareholder Trust" means a trust in respect of which any of the income beneficiaries comprise persons who are of a class or classes identified by reference to any of:

- (a) the person's connection to the Network;
- (b) the person's receipt of electricity from the Distributor;
- (c) the person's liability for payment for supply of electricity from the Distributor;
- (d) the person's liability for payment for the connection to the Network;
- (e) the person's liability for payment for Distribution Services supplied by the Distributor; or

(f) the person's domicile or location or operation within the geographic area or areas of operation of the Distributor;

"Trader" means the party identified as such in this Agreement

"Unmetered Load" means electricity consumed on the Network that is not directly recorded using Metering Equipment, but is calculated or estimated in accordance with the Code;

"Unplanned Service Interruption" means any Service Interruption where events or circumstances prevent the timely communication of prior warning or notice to the Trader or any affected Customer.

Sch 12A.1, cl 7(2)

Schedule 12A.1, Appendix C
Default agreement – Provision of consumption data

AGREEMENT dated 20[]

PARTIES

Distributor: [insert full legal name of the Distributor]	Trader: [insert full legal name of the Trader]
Distributor's Details: Street Address: [insert] Postal Address: [insert] Address for Notices: [insert] Contact Person's Details: Phone: [insert] Fax: [insert] Website: [insert] Email Address: [insert]	Trader's Details: Street Address: [insert] Postal Address: [insert] Address for Notices: [insert] Contact Person's Details: Phone: [insert] Fax: [insert] Website: [insert] Email Address: [insert]

COMMENCEMENT DATE

[insert date]

SIGNATURES

[Parties can sign the Agreement using the signature block below, but see clause 7 of Schedule 12A.1 of the Code, which provides for the Agreement to apply as a binding contract in certain circumstances]

_____ Signature	_____ Signature
_____ Name of authorised person signing for Distributor	_____ Name of authorised person signing for Trader
_____ Position	_____ Position
_____ Date	_____ Date

INTRODUCTION

- A. The Distributor and Trader are parties to a Distributor Agreement, and have agreed to enter into this agreement for additional services relating to the provision of Consumption Data in accordance with a notice given by the [Distributor or Trader] under clause 7 of Schedule 12A.1 of the Code.

TERMS

1 Introduction

This Agreement sets out provisions that apply in relation to requests by the Distributor for Consumption Data held by the Trader or the Trader's Metering Equipment Provider.

2 Consumption Data requests

The Distributor may request Consumption Data by giving written notice to the Trader, which must set out:

- (a) details about the Consumption Data requested;
- (b) the purposes for which the Distributor will use the Consumption Data;
- (c) the persons to whom the Consumption Data will be disclosed by the Distributor; and
- (d) for how long the Distributor wishes to use the Consumption Data.

3 Provision of Consumption Data for Permitted Purposes

- (1) The Trader must supply (or procure that its Metering Equipment Provider supplies) the requested Consumption Data to the Distributor if:
 - (a) the purposes for which the Distributor will use the Consumption Data are Permitted Purposes;
 - (b) the persons to whom the Consumption Data will be disclosed by the Distributor are persons who are permitted to access the Consumption Data under this Agreement; and
 - (c) the frequency of access requested by the Distributor is no more than once every six months, unless otherwise agreed by the parties in accordance with clause 4.
- (2) If the Trader is required to supply Consumption Data under this clause, the Trader must supply (or procure that its Metering Equipment Provider supplies) the requested Consumption Data within 10 Working Days of the Distributor's request, and at six monthly intervals after that if the Distributor's request is for ongoing access to the Consumption Data.
- (3) When the Trader supplies Consumption Data in accordance with subclause (2), the Trader must:
 - (a) for all time of use meters to which the Consumption Data relates, supply half hourly data collected from the relevant Metering Equipment or Metering Equipment Provider in accordance with EIEP3;
 - (b) for all other meters to which the Consumption Data relates, supply non-half hourly data at the frequency for which it was collected; and
 - (c) use reasonable endeavours to provide the Consumption Data in a format requested by the Distributor, or if the Trader is not able to provide the Consumption Data in

- the format requested by the Distributor, provide the Consumption Data in a structured, commonly used, and machine-readable format; and
- (d) not do anything that could introduce a virus, Trojan horse, malicious code or similar when transmitting the Consumption Data, and must ensure the Consumption Data is transmitted in an encrypted form that is current best practice and commonly supported.
- (4) Despite subclause (2), the Trader will not be responsible for any delay in providing Consumption Data to the Distributor due to circumstances beyond its control.

4 Provision of Consumption Data on other terms or for Other Purposes

- (1) If the purposes for which the Distributor will use the requested Consumption Data include Other Purposes or the Distributor seeks access on terms that are different to the terms in clause 3, the parties may agree to enter into an agreement ("Data Agreement") in the form set out in clause 20, which sets out:
- (a) the Consumption Data to be provided by the Trader (or the Trader's Metering Equipment Provider) to the Distributor;
 - (b) the Other Purposes for which the Distributor may use the Consumption Data;
 - (c) the persons to whom the Consumption Data may be disclosed by the Distributor;
 - (d) the frequency at which Consumption Data will be supplied;
 - (e) for how long the Distributor may use the Consumption Data; and
 - (f) the format in which Consumption Data will be supplied.
- (2) The Trader must supply (or procure that its Metering Equipment Provider supplies) the Consumption Data in accordance with the Data Agreement and clause 3(3)(d).
- (3) The Data Agreement may be amended, with the agreement of both parties, from time to time.

5 Use of Consumption Data

- (1) The Trader grants the Distributor a non-exclusive, limited, non-transferrable (except in accordance with this Agreement) licence to use and disclose the Consumption Data supplied in accordance with this Agreement, subject to the following:
- (a) the Distributor may use the Consumption Data only for the Permitted Purposes as defined in this Agreement and any Other Purposes agreed by the parties as set out in a Data Agreement;
 - (b) the Consumption Data may not be used for any other purposes;
 - (c) the Consumption Data supplied for Other Purposes may only be used by the Distributor for the permitted time period as defined in the Data Agreement or as otherwise set out in this Agreement;
 - (d) the Consumption Data must not be disclosed to any person outside of New Zealand without the prior written agreement of the Trader, but the Distributor may transfer the Consumption Data to a person who is responsible for storing or processing the data on behalf of the Distributor outside New Zealand provided the Distributor ensures that any applicable provisions of the Privacy Act 2020 are complied with in respect of the transfer;
 - (e) the Consumption Data must not be combined with any other data or database without the prior written agreement of the Trader; and
 - (f) the Distributor acknowledges that the Distributor has no rights (including copyright) to or in connection with the Consumption Data, including in any database structures and compilations of the Consumption Data, other than the rights expressly set out in this Agreement.

- (2) The Distributor agrees that any Consumption Data provided to the Distributor will be:
- (a) at the Distributor's cost, as set out in clause 6, so that the Trader is not responsible for any reasonable costs, charges, or other expenses associated with providing the Consumption Data to the Distributor; and
 - (b) at the Distributor's risk, and the Trader makes no express or implied warranties as to the accuracy or completeness of the Consumption Data, nor its suitability for any specified purpose.

Schedule 12A.1, Appendix C, clause 5(1)(d): amended, on 1 March 2024, by clause 65 of the Electricity Industry Participation Code Amendment (Code Review Programme) 2024.

6 Payment of Trader's reasonable costs

- (1) The Distributor must pay the Trader's or the Trader's Metering Equipment Provider's reasonable costs incurred in supplying any information requested under clause 2.
- (2) If requested by the Distributor, the Trader must give (or procure that its Metering Equipment Provider gives) the Distributor a quote for any reasonable costs for supplying the information before the Trader or the Trader's Metering Equipment Provider supplies the information.
- (3) The Distributor must pay the Trader's (or the Trader's Metering Equipment Provider's) GST invoice for supplying the information no later than the 20th of the month following the invoice date.

7 Privacy Act

- (1) Each party acknowledges and agrees that it must comply at all times with the Privacy Act 2020 to the extent it applies in relation to the Consumption Data.
- (2) The Trader must make any disclosures, and obtain any authorisations, needed under the Privacy Act 2020 to enable the Distributor to use the Consumption Data for the Permitted Purposes and Other Purposes.

Schedule 12A.1, Appendix C, clause 7(1) and (2): amended, on 1 March 2024, by clause 66 of the Electricity Industry Participation Code Amendment (Code Review Programme) 2024.

8 Confidentiality obligations

The Distributor agrees that it will:

- (a) preserve the confidentiality of, and will not directly or indirectly reveal, report, publish, transfer, or disclose any Consumption Data except as provided for in this Agreement; and
- (b) only use Consumption Data for a Permitted Purpose or for any Other Purpose specified in a Data Agreement.

9 Disclosure of Consumption Data

- (1) Subject to subclause (3), the Distributor may disclose Consumption Data in any of the following circumstances:
 - (a) to its employees and directors to the extent that such Consumption Data is required to be known by such persons in connection with the Permitted Purposes or Other Purposes;
 - (b) to its agents, advisors, or contractors to the extent that such Consumption Data is required to be known by such persons in connection with the Permitted Purposes or Other Purposes, on terms that are no less onerous than those set out in this Agreement (unless otherwise agreed in writing by the Trader) and only on the basis that the Distributor is liable for the acts and omissions of such agents, advisors, or contractors in connection with their use of the Consumption Data; or
 - (c) if the Distributor is required to disclose the Consumption Data by:
 - (i) law, or by any statutory or regulatory body or authority; or
 - (ii) any judicial or other arbitration process.

- (2) If the Distributor discloses Consumption Data under subclause (1)(c), the Distributor must notify the Trader of the disclosure (unless such notification is prohibited by law).
- (3) The Distributor may not, except as expressly set out in a Data Agreement or with the prior written approval of the Trader, disclose any Consumption Data to any employee, director, agent, advisor, contractor, or related company (as defined in section 2(3) of the Companies Act 1993) of the Distributor who is involved in the offering, provision, marketing, or sale of:
 - (a) electricity generation, retail, or storage goods or services (including batteries, solar, and other products and services sold on a competitive basis) to Customers; or
 - (b) any other products or services not regulated under Part 4 of the Commerce Act to Customers.
- (4) The Distributor must maintain a register of persons who are permitted to access the Consumption Data under this clause ("Data Team").
- (5) The Distributor must:
 - (a) disclose Consumption Data only to members of the Data Team; and
 - (b) ensure that each member of the Data Team:
 - (i) is trained to understand the confidentiality obligations in this Agreement;
 - (ii) complies with the confidentiality obligations in this Agreement;
 - (iii) uses Consumption Data only for a Permitted Purpose or for any Other Purpose set out in a Data Agreement;
 - (iv) does not disclose Consumption Data to any person who is not a member of the Data Team, other than as provided for in this Agreement or a Data Agreement;
 - (v) does not leave Consumption Data, whether in a physical or electronic medium, unsecured in such a way that it might be accessed by a person who is not a member of the Data Team; and
 - (vi) complies with any requirements imposed on Data Team members by any information security plan developed in accordance with clause 10.
- (6) Despite anything in this Agreement, the Distributor and Data Team members may release, to Network Services Personnel other than persons who are described as persons who must not be included in the Data Team in subclause (3), Consumption Data if necessary to enable Network Services Personnel to carry out surveying, installations, or maintenance of equipment, or otherwise carry out works on Network assets or at a Customer's Premises.
- (7) To avoid doubt, nothing in this Agreement prevents the Distributor from using or disclosing information that is derived from aggregated Consumption Data if the information is used or disclosed in such a form that could not reasonably be expected to identify any individual, single ICP, or Trader to which the Consumption Data relates.

10 Information security plan

- (1) The Distributor must maintain an information security plan to ensure that only Data Team members are able to access the Consumption Data.
- (2) The information security plan must:
 - (a) ensure that Consumption Data is physically and electronically quarantined and unable to be accessed by any person other than Data Team members;
 - (b) include provisions for training of Data Team members on the requirements set out in this Agreement and the information security plan;

- (c) keep the Consumption Data under the Distributor's control, using measures that are at least as secure as those used by the Distributor for its own confidential information;
- (d) effect and maintain adequate security measures that preserve and secure the confidential nature of the Consumption Data and safeguard the Consumption Data from loss, unauthorised access, use, modification, or disclosure, and other misuse;
- (e) implement, to the extent practicable, measures to monitor or prevent the transmission of Consumption Data using external electronic storage devices (for example USB flash drives);
- (f) include measures to protect electronic files containing Consumption Data (for example password protection and data encryption);
- (g) include provision for the secure storage of any Consumption Data in the form of physical media; and
- (h) include a process to:
 - (i) inform the Trader, as soon as practicable and in any case no later than 72 hours after discovery, if the Distributor becomes aware of any loss, unauthorised access, use, modification, or disclosure, or other misuse of the Consumption Data; and
 - (ii) at the request of the Trader, provide all such assistance in relation to the mitigation and remediation of such breach as the Trader may require.

11 Steps to address breaches

If the Distributor becomes aware of a breach of an obligation in this Agreement or the information security plan, the Distributor must:

- (a) immediately take all reasonable steps to:
 - (i) retrieve any Consumption Data that has been disclosed outside of the Data Team; and
 - (ii) mitigate any use of Consumption Data in breach of this Agreement;
- (b) investigate each breach and produce a report on the incident together with recommendations for preventing a reoccurrence of a breach;
- (c) notify the Trader in writing of any breach of an obligation in this Agreement and provide it with a copy of the report; and
- (d) maintain a record of all known breaches.

12 Liability and indemnity

- (1) The Distributor indemnifies and holds harmless the Trader, and will keep the Trader indemnified and held harmless, from and against any direct or indirect loss or damage (including legal costs on a solicitor/own client basis) suffered or incurred by the Trader arising out of or in connection with any breach of the Distributor's obligations under this Agreement.
- (2) The Distributor's liability for breach of this Agreement will not be limited by this Agreement or any other agreement entered into by the parties.
- (3) The Distributor acknowledges and agrees that:
 - (a) in the event of an alleged breach of the Distributor's obligations under this Agreement, damages may not be an adequate remedy and the Trader will be entitled to seek equitable relief, including injunction and specific performance, in addition to all other remedies available to the Trader; and
 - (b) the rights, powers, and remedies provided in this Agreement are cumulative and are in addition to any rights, powers, or remedies provided by law.

13 Audit

- (1) Subject to subclause (4), the Trader may conduct periodic audits to confirm that the Distributor is meeting its obligations in respect of Consumption Data supplied under this Agreement, as follows:
 - (a) audits may be conducted at any time, but no more than once in any twelve month period;
 - (b) audits must be preceded by at least 14 days prior written notice by the Trader;
 - (c) audits must be conducted using an independent external auditor of the Trader's choice;
 - (d) the Distributor must provide the auditor with all reasonable access to all books, accounts, records, documents, and systems reasonably required by the auditor; and
 - (e) the auditor's costs will be borne by the Trader, unless any audit determines that there has been non-compliance with the Distributor's obligations in respect of Consumption Data supplied under this Agreement (in which event, the costs must be met by the Distributor).
- (2) The Trader has the right to publish the results of the audit.
- (3) More than one Trader may collectively conduct an audit under subclause (1) as if the Traders were a single Trader.
- (4) The Trader must not exercise the rights in subclause (1) if the Distributor has, within the previous 12 months, conducted an audit that complies with the following requirements:
 - (a) the audit was conducted using an independent external auditor of the Distributor's choice;
 - (b) the Distributor provided the auditor with all reasonable access to all books, accounts, records, documents, and systems reasonably required by the auditor;
 - (c) the Distributor provided the Trader with confirmation from the auditor of any results that identify any non-compliance by the Distributor with its obligations, or confirmation from the auditor of the Distributor's compliance (as the case may be).
- (5) If the Distributor undertakes an audit in accordance with subclause (4):
 - (a) the audit may consider the Distributor's compliance with its obligations owed to the Trader (and any one or more other traders) in respect of the Consumption Data provided to it by the Trader (and those other traders);
 - (b) the audit will be at the Distributor's own cost; and
 - (c) the Trader must treat any information concerning the audit provided by the Distributor or its auditor as confidential.

14 Breaches and events of default

- (1) Subject to clause 14(6), if either party (the "Defaulting Party") fails to comply with any of its obligations under this Agreement, the other party may notify the Defaulting Party that it is in breach of this Agreement. The Defaulting Party must remedy a breach within the following timeframe:
 - (a) in the case of a Serious Breach by the Distributor, within 2 Working Days of the date of receipt of such notice; or
 - (b) in any other case, within 5 Working Days of the date of receipt of such notice.
- (2) If the Trader considers the Distributor has committed a Serious Breach, the Trader may give notice to the Distributor under clause 14(1) and a notification under clause 14(4).
- (3) If the Defaulting Party fails to remedy the breach within the relevant timeframe set out in clause 14(1):

- (a) the breach is an Event of Default for the purposes of this Agreement;
 - (b) the other party must use reasonable endeavours to speak with the Chief Executive or another senior executive of the Defaulting Party in relation to the Event of Default, and to notify him or her of the other party's intention to exercise its rights under this clause 14; and
 - (c) the Defaulting Party must continue to do all things necessary to remedy the breach as soon as practicable.
- (4) If the Event of Default is any of the following:
- (a) a Serious Breach (in the case of the Distributor only);
 - (b) a material breach of the Defaulting Party's obligations under this Agreement that is not in the process of being remedied to the reasonable satisfaction of the other party; or
 - (c) the Defaulting Party has failed on at least 2 previous occasions within the last 12 months to meet an obligation under this Agreement within the time specified and has received notice of such failures from the other party in accordance with clause 14 and, whether each individual failure is in itself material or not, if all such failures taken cumulatively materially adversely affect the other party's rights or the other party's ability to carry out its obligations under this Agreement or, if the Defaulting Party is the Distributor, the Trader's ability to carry out its obligations under any agreement with any other industry participant,
- then no earlier than 1 Working Day after the end of the timeframe set out in clause 14(1), the other party may do 1 or both of the following:
- (d) issue a notice of termination in accordance with clause 15(2);
 - (e) exercise any other legal rights available to it.
- (5) If a breach is not an Event of Default, the non-breaching party may:
- (a) refer the matter to dispute resolution in accordance with any existing dispute resolution clauses included in this Agreement no earlier than 1 Working Day after the end of the timeframe set out in clause 14(1); and
 - (b) exercise any other legal rights available to it.
- (6) Despite subclause (1), if either party is subject to an Insolvency Event, the other party may:
- (a) immediately issue a notice of termination in accordance with clause 15(2);
 - (b) exercise any other legal rights available to it.

15 Termination of Agreement

- (1) A party may terminate this Agreement as set out below:
- (a) both parties may agree to terminate this Agreement;
 - (b) either party may terminate this Agreement in accordance with subclause (2);
 - (c) either party may terminate this Agreement 1 Working Day after notice is given by either party to the other party terminating this Agreement for the reason that performance of any material provision of this Agreement by either party has to a material extent become illegal and the parties acting reasonably agree that despite the operation of any severance clauses in this Agreement it is not practicable for this Agreement to continue.
- (2) If a party has breached this Agreement and the breach is an Event of Default, or a party has become subject to an Insolvency Event, the other party may (immediately in the

case of an Insolvency Event, and not less than 1 Working Day after the end of the timeframe set out in clause 14(1) in the case of an Event of Default) issue a notice of termination to the defaulting party, effective either:

- (a) no less than 5 Working Days after the date of such notice; or
 - (b) immediately if the Trader has ceased to supply electricity to all Customers.
- (3) A party that has given a notice under clause 15(2) may give a notice extending the date on which the notice given under clause 15(2) takes effect.
 - (4) A notice of termination given under clause 15(2) will lapse if the defaulting party remedies the Event of Default or Insolvency Event (as applicable) prior to the notice of termination becoming effective or the other party withdraws the effective date of its notice.
 - (5) Termination of this Agreement by either party will be without prejudice to all other rights or remedies of either party, and all rights of that party accrued as at the date of termination.
 - (6) The parties must continue to meet their responsibilities under this Agreement up to the effective date of termination.
 - (7) Any terms of this Agreement that by their nature extend beyond its expiration or termination remain in effect until fulfilled.

16 Destruction of Consumption Data

- (1) On termination of this Agreement, or once any Consumption Data has been used by the Distributor for the relevant Permitted Purpose or Other Purpose, the Distributor must, unless otherwise agreed by the Trader, promptly destroy or permanently erase, or procure the destruction or erasure of, all copies (whether on paper or in any electronic information storage and retrieval system or in any other storage medium) of any documents held by the Distributor which contain any Consumption Data.
- (2) The Distributor must provide, no later than 5 Working Days after the destruction of all such Consumption Data, a certificate to the Trader in the form set out in clause 21 confirming that all such Consumption Data has been destroyed.
- (3) Subclause (1) does not apply to Consumption Data contained in electronic back-up facilities that are not readily accessible (provided the Consumption Data contained in the electronic back-up facilities is not restored or used).

17 Surviving terms

The following clauses of this Agreement survive the expiry or termination of this Agreement:

- (a) clause 5;
- (b) clause 7;
- (c) clause 8;
- (d) clause 9;
- (e) clause 12;
- (f) clause 13;
- (g) clause 14;
- (h) clause 16; and
- (i) any other clause intended to survive termination.

18 Other provisions

- (1) An obligation not to do something under this Agreement includes an obligation not to permit, suffer, or cause something to be done.

- (2) Unless otherwise agreed by the parties, the rights and obligations contained in this Agreement may not be transferred or assigned to a different party.
- (3) A provision, or part of a provision, of this Agreement that is illegal or unenforceable may be severed from this Agreement and the remaining provisions or parts of this Agreement will continue in force.
- (4) The parties agree:
 - (a) this Agreement (including any Data Agreement entered into in accordance with this Agreement) is the entire agreement between the parties regarding the Consumption Data and supersedes, in relation to the Consumption Data only, any previous agreement, understanding, or negotiations about the Consumption Data; and
 - (b) in the event of any inconsistency between this Agreement and any previous agreement, understanding, or negotiations in relation to the Consumption Data, this Agreement prevails.
- (5) If there is a dispute in relation to this Agreement, the senior management of the Distributor and Trader will try to resolve the dispute, and may refer the dispute to mediation if they are unable to resolve the dispute within 15 Working Days of it being raised by a party.

19 Notices

- (1) Any notice given under this Agreement must be in writing and will be deemed to be validly given if personally delivered, posted, or sent by facsimile transmission or email to the address for notice set out in the Parties section of this Agreement or to such other address as that party may notify from time to time.
- (2) Any notice given under this Agreement will be deemed to have been received:
 - (a) in the case of personal delivery, when delivered;
 - (b) in the case of facsimile transmission, when sent, provided that the sender has a facsimile confirmation receipt recording successful transmission;
 - (c) in the case of posting, 3 Working Days following the date of posting; and
 - (d) in the case of email, when actually received in readable form by the recipient, provided that a delivery failure notice has not been received by the sender, in which case the notice will be deemed not to have been sent.
- (3) Any notice given in accordance with subclause (2) that is personally delivered or sent by facsimile or email after 5pm on a Working Day or on any day that is not a Working Day will be deemed to have been received on the next Working Day.

20 Data Agreement

This Data Agreement applies to Consumption Data provided by **[Insert Trader's Name] (Trader)** to **[Insert Distributor's Name] (Distributor)** for *[insert Permitted Purposes or Other Purposes]*.

The Trader and the Distributor agree that the Consumption Data will be supplied by the Trader (or that the Trader will procure that its Metering Equipment Provider will supply the Consumption Data), and may be used by the Distributor, in accordance with the terms below and the Agreement relating to the provision of Consumption Data between the Trader and Distributor. Capitalised terms used but not defined in this Data Agreement have the meaning given to them in the Agreement relating to the provision of Consumption Data.

Description of Consumption Data provided: *[insert details of the Consumption Data that will be provided]*

Purposes of the Consumption Data: *[insert details of any permitted uses of the Consumption Data]*

Persons to whom the Consumption Data may be disclosed: *[insert details of the person(s) authorised to access the Consumption Data]*

Frequency of Access: *[tick appropriate frequency of Consumption Data supply]*

Single access , or

Ongoing Access:

Daily Weekly Monthly Quarterly Annually Other

Permitted Time Period:

a) Start date: _____ *[insert date]*

b) End date: _____ *[insert date]*; or until notice of termination

The format in which Consumption Data will be supplied: *[insert details of the format for supplying Consumption Data]*

If required, outline any Business and/or General requirements: *[insert details of any Business and/or General requirements]*

<i>For [insert Distributor's name]</i>	<i>For [insert Trader's name]</i>
Signature: _____	Signature: _____
Name: _____	Name: _____
Title: _____	Title: _____
Date: _____	Date: _____

21 Consumption Data destruction certificate

**[Insert Distributor's Name]
Consumption Data Destruction Certificate**

I certify that the Consumption Data received by *[me]* and described below, including all

copies (whether on paper or in any electronic information storage and retrieval system or in any other storage medium) of that data in the Distributor's possession or control, has been destroyed, or erased from the Distributor's systems in accordance with the agreement between *[Distributor]* and *[Trader]* relating to the provision of Consumption Data.

Description of Consumption Data: *[insert details]*

Date Consumption Data received: *[insert date]*

Details of copies of the Consumption Data made (if any): *[insert details]*

Signature: _____

Name: _____

Title: _____

Date: _____

22 Definitions

In this Agreement:

"**Agreement**" means this agreement relating to the provision of Consumption Data;

"**Code**" means the Electricity Industry Participation Code 2010 made under the Electricity Industry Act 2010;

"**Consumption Data**" means electricity consumption data collected by the Trader or the Trader's Metering Equipment Provider for each ICP the Trader supplies, and which the Trader or the Trader's Metering Equipment Provider holds or obtains, but does not include aggregated and anonymised information contained in documents, reports, analyses, or other materials that are prepared for a Permitted Purpose or Other Purpose;

"**Customer**" means a person who purchases electricity from the Trader that is delivered via the Network;

"**Customer's Installation**" means an Electrical Installation and includes Distributed Generation, if Distributed Generation is connected to a Customer's Installation;

"**Customer's Premises**" means the land and buildings owned or occupied by a Customer, and any land over which the Customer has an easement or right to pass electricity, including:

- (a) the land within the boundary within which the electricity is consumed;
- (b) the whole of the property, if the property is occupied wholly or partially by tenants or licensees of the owner or occupier; and
- (c) the whole of the property that has been subdivided under the Unit Titles Act 1972 or Unit Titles Act 2010;

"**Data Team**" means persons who are permitted to access Consumption Data.

"**De-energise**" means the operation of any isolator, circuit breaker, or switch or the removal of any fuse or link so that no electricity can flow through a Point of Connection on the Network;

"Distributed Generation" means generating plant equipment collectively used for generating electricity that is connected, or proposed to be connected, to the Network or a Customer's Installation, but does not include:

- (a) generating plant connected to the Network and operated by the Distributor for the purpose of maintaining or restoring the provision of electricity to part or all of the Network:
 - (i) as a result of a Planned Service Interruption; or
 - (ii) as a result of an Unplanned Service Interruption; or
 - (iii) during a period when the Network capacity would otherwise be exceeded on part or all of the Network; or
- (b) generating plant that is only momentarily synchronised with the Network for the purpose of switching operations to start or stop the generating plant;

"Distribution Services" means the service of distribution, as defined in section 5 of the Electricity Industry Act 2010;

"Distributor" means the party identified as such in this Agreement;

"Distributor Agreement" means a distributor agreement as defined in the Code;

"EIEP" means an electricity information exchange protocol approved by the Electricity Authority and published in accordance with the Code;

"Electrical Installation" means:

- (a) all Fittings that form part of a system for conveying electricity at any point from the Customer's Point of Connection to any point from which electricity conveyed through that system may be consumed; and
- (b) includes any Fittings that are used, or designed or intended for use, by any person, in or in connection with the generation of electricity for that person's use and not for supply to any other person; but
- (c) does not include any appliance that uses, or is designed or intended to use, electricity, whether or not it also uses, or is designed or intended to use, any other form of energy;

"Fitting" means everything used, designed, or intended for use, in or in connection with the generation, conversion, transformation, conveyance, or use of electricity;

"Grid" means the system of transmission lines, substations and other works, including the HVDC link used to connect grid injection points and GXPs to convey electricity throughout the North Island and the South Island of New Zealand;

"GST" means goods and services tax payable under the GST Act;

"GST Act" means the Goods and Services Tax Act 1985;

"GXP" means any Point of Connection on the Grid:

- (a) at which electricity predominantly flows out of the Grid; or
- (b) determined as being such in accordance with the Code;

"ICP" means an installation control point being 1 of the following:

- (a) a Point of Connection at which a Customer's Installation is connected to the Network;
- (b) a Point of Connection between the Network and an embedded network;
- (c) a Point of Connection between the Network and shared Unmetered Load;

"Insolvency Event" means a party:

- (a) has had a receiver, administrator, or statutory manager appointed to or in respect of the whole or any substantial part of its undertaking, property, or assets;

- (b) is deemed or presumed (in accordance with law) to be unable to pay its debts as they fall due, becomes or is deemed (in accordance with law) to be insolvent, or is in fact unable to pay its debts as they fall due, or proposes or makes a compromise, or an arrangement or composition with or for the benefit of its creditors or fails to comply with a statutory demand under section 289 of the Companies Act 1993; or
- (c) is removed from the register of companies (otherwise than as a consequence of an amalgamation) or an effective resolution is passed for its liquidation;

"Metering Equipment" means any apparatus for the purpose of measuring the quantity of electricity transported through an ICP along with associated communication facilities to enable the transfer of metering information;

"Metering Equipment Provider" means a metering equipment provider as defined in the Electricity Industry Act 2010;

"Network" means the Distributor's lines, substations and associated equipment used to convey electricity between:

- (a) 2 NSPs; or
- (b) an NSP and an ICP;

"Network Services Personnel" means any person appointed from time to time by the Distributor in relation to Electrical Installations, maintenance of equipment, or other works on network assets or at a Customer's Premises, including contractors (and their subcontractors);

"Network Supply Point" or **"NSP"** means any Point of Connection between:

- (a) the Network and the Grid; or
- (b) the Network and another distribution network; or
- (c) the Network and an embedded network; or
- (d) the Network and Distributed Generation;

"Other Purposes" means the other purposes (in addition to the Permitted Purposes) for which the Distributor may use the Consumption Data as agreed by the parties;

"Permitted Purposes" means:

- (a) developing distribution prices,
- (b) planning and management of the Network in order to provide Distribution Services to traders under the Distributor's distributor agreements;

"Planned Service Interruption" means any Service Interruption that has been scheduled to occur in accordance with this Agreement;

"Point of Connection" means the point at which electricity may flow into or out of the Network;

"Serious Breach" means:

- (a) the second of two or more breaches in a twelve-month period, or
- (b) an event which directly affects 10% or more of the Trader's ICPs simultaneously;

"Service Interruption" means the cessation of electricity supply to an ICP for a period of 1 minute or longer, other than by reason of De-energisation of that ICP;

"Trader" means the party identified as such in this Agreement;

"Unmetered Load" means electricity consumed on the Network that is not directly recorded using Metering Equipment, but is calculated or estimated in accordance with the Code;

"Unplanned Service Interruption" means any Service Interruption where events or circumstances prevent the timely communication of prior warning or notice to the Trader or any affected Customer;

"Working Day" means every day except Saturdays, Sundays, and days that are statutory holidays in the city specified for each party's address for notices identified in the Parties section of this Agreement.

Schedule 12A.2

cl 12A.2(1)

Other provisions applying to distributor and participant arrangements

1 Content and application of this Schedule

This Schedule sets out provisions that apply to each **distributor** described in a row in column 1 below, and each **participant** described in column 2 of the row:

Row	Column 1 – Distributor	Column 2 – Participant
1	Each distributor that owns or operates a local network , and has an interposed arrangement with 1 or more traders trading on the local network	Each trader that is a retailer , and is trading or wishes to trade at an ICP on the network of a distributor described in column 1 of this row
2	Each distributor that owns or operates an embedded network , and has an interposed arrangement with 1 or more traders trading on the embedded network	Each trader that is a retailer , and is trading or wishes to trade at an ICP on the network of a distributor described in column 1 of this row

Exchange of information

2 Authority may prescribe EIEPs that must be used

- (1) The **Authority** may prescribe 1 or more **EIEPs** that set out standard formats that the **distributors** and **participants** specified in the **EIEP** must use when exchanging information.
- (2) The **Authority** must **publish** an **EIEP** that it prescribes under subclause (1).
- (3) When prescribing an **EIEP** under subclause (1), the **Authority** must specify the date on which the **EIEP** will come into effect.
- (4) Before the **Authority** prescribes an **EIEP** under subclause (1), or amends an **EIEP** it has prescribed under subclause (1), it must consult with the **participants** that the **Authority** considers are likely to be affected by the **EIEP**.
- (5) The **Authority** need not comply with subclause (4) if it proposes to amend an **EIEP** prescribed under subclause (1) if the **Authority** is satisfied that—
 - (a) the nature of the amendment is technical and non-controversial; or
 - (b) there has been adequate prior consultation so that the **Authority** has considered all relevant views.

3 Distributors and participants to comply with EIEPs

- (1) If the **Authority** prescribes an **EIEP** under clause 2, the **distributor** and each **participant** to which the **EIEP** applies must, when exchanging information to which the **EIEP** relates, comply with the **EIEP** from the date on which the **EIEP** comes into effect.
- (2) However, a **distributor** and a **participant** may, after the **Authority** prescribes an **EIEP**, agree to exchange information other than in accordance with the **EIEP**, by

recording the agreement in the **distributor agreement** between the **distributor** and the **participant**.

- (3) An agreement to exchange information other than in accordance with an **EIEP** is not effective in relieving a **distributor** and a **participant** of the obligation to comply with subclause (1), unless the agreement comes into effect on or after the date on which the relevant **EIEP** comes into effect.
- (4) An agreement under subclause (2) is not affected by the **Authority** prescribing an amendment to the **EIEP**.

4 Transitional provision relating to EIEPs

Any **EIEP** that a **distributor** or a **participant** was required to comply with immediately before this clause came into force is deemed to be an **EIEP** prescribed under clause 2.

Schedule 12A.3

cl 12A.2(1)

Requirements for distributors and traders on embedded networks (interposed)

1 Content and application of this Schedule

This Schedule sets out provisions that apply to each **distributor** described in a row in column 1 below, and each **participant** described in column 2 of the row:

Row	Column 1 – Distributor	Column 2 – Participant
1	Each distributor that owns or operates an embedded network , and has an interposed arrangement with 1 one or more traders trading on the embedded network	Each trader that is a retailer , and is trading or wishes to trade at an ICP on the network of a distributor described in column 1 of this row

Distributor agreement

2 Obligation to enter into distributor agreement

- (1) A **trader** trading on a **distributor's embedded network** must have a **distributor agreement** with the **distributor**.
- (2) A **trader** must ensure that the **distributor agreement** comes into force on or before the day on which the **trader** commences trading on the **embedded network**.
- (3) A **trader** that wishes to trade on a **distributor's embedded network** must give notice to the **distributor** of that fact at least 20 **business days** before the **trader** proposes to commence trading on the **embedded network**.

Prudential requirements

3 Prudential requirements

Clauses 4 to 8 apply in relation to a **distributor agreement** between a **distributor** and a **trader** if—

- (a) the **distributor** has an **interposed arrangement** with 1 or more **traders** trading on the **embedded network**; and
- (b) the **distributor** requires that the **distributor agreement** provide that the **trader**—
 - (i) must comply with prudential requirements; or
 - (ii) must comply with prudential requirements if required to do so by the **distributor**.

4 Election of prudential requirements

- (1) The **distributor** must ensure that the **distributor agreement** provides that the **trader** may elect to comply with the prudential requirements in either of the following ways:
 - (a) the **trader** must maintain an acceptable credit rating in accordance with clause 5; or
 - (b) the **trader** must provide and maintain acceptable security by, at the **trader's** election,—

- (i) providing the **distributor** with a cash deposit; or
 - (ii) arranging for a third party with an acceptable credit rating to provide that security in a form acceptable to the **distributor**; or
 - (iii) providing a combination of the securities described in subparagraphs (i) and (ii).
- (2) The **distributor** must ensure that the **distributor agreement** provides that the **trader** may change its election at any time.

5 Meaning of acceptable credit rating

For the purpose of clause 4(1)(a) and 4(1)(b)(ii), a **trader** or third party has an acceptable credit rating if it—

- (a) carries a long term credit rating of at least—
 - (i) BBB- (Standard & Poors Rating Group); or
 - (ii) a rating that is equivalent to the rating specified in subparagraph (i) from a rating agency that is an approved rating agency for the purposes of section 86 of the Non-bank Deposit Takers Act 2013; and
- (b) is not subject to negative credit watch or any similar arrangement by the agency that gave it the credit rating.

6 Meaning of acceptable security

- (1) Subject to clause 7, the value of the acceptable security described in clause 4(1)(b) must be the **distributor's** reasonable estimate of the **distribution** services charges that the **trader** will be required to pay to the **distributor** in respect of any period of not more than 2 weeks.
- (2) The **distributor** must ensure that its **distributor agreement** specifies that, if the **trader** elects to provide acceptable security as described in clause 4(1)(b), the **distributor** must—
 - (a) hold any security provided by the **trader** in the form of a cash deposit in a trust account in the name of the **trader** at an interest rate that is the best on-call rate reasonably available at the time the **trader** provides the cash deposit; and
 - (b) pay interest earned in respect of the cash deposit to the **trader** on a quarterly basis, net of account fees and any amounts that are required to be withheld by law.

7 Distributor may require additional security

- (1) A **distributor** may require that its **distributor agreement** provides 1 or both of the following:
 - (a) that if the **trader** elects to provide acceptable security as specified in clause 4(1)(b), the **trader** must provide acceptable security that is additional to the amount provided for in clause 6(1);
 - (b) that the **distributor** may, during the term of the **distributor agreement**, require the **trader** to provide such additional security.
- (2) If a **distributor agreement** has a provision provided for in subclause (1), the **distributor** must ensure that the total value of additional security specified in the **distributor agreement** is such that the total value of all security required to be provided by the **trader** is not more than the **distributor's** reasonable estimate of the **distribution** services charges that the **trader** will be required to pay to the **distributor** in respect of any 2 month period.

- (3) If a **distributor agreement** has a provision provided for in subclause (1), the **distributor** must ensure that the **distributor agreement** provides the following:
- (a) if any additional security provided by the **trader** is in the form of a cash deposit, the **distributor** must pay a charge to the **trader** for each day that the **distributor** holds the additional security at a per annum rate equal to the sum of the bank bill yield rate for that day plus 15% on the amount of additional security held on that day;
 - (b) if any additional security provided by the **trader** is in the form of security from a third party, the **distributor** must pay a charge to the **trader** for each day that the **distributor** holds the additional security at a per annum rate of 3% on the amount of additional security held on that day;
 - (c) any money required to be paid by the **distributor** to the **trader** as specified in paragraph (a) or (b) must be paid by the **distributor** to the **trader** on a quarterly basis.
- (4) For the purposes of this clause, the bank bill yield rate is—
- (a) the daily bank bill yield rate (rounded upwards to 2 decimal places) published on the wholesale interest rates page of the website of the Reserve Bank of New Zealand (or its successor or equivalent page) on that day as being the daily bank bill yield for bank bills having a tenor of 90 days; or
 - (b) for any day for which such a rate is not available, the bank bill yield rate is deemed to be the bank bill yield rate determined in accordance with paragraph (a) on the last day that such a rate was available.

8 Agreement to less onerous terms

Despite clauses 4 to 7, a **distributor** and a **trader** may agree prudential requirements that are less onerous on the **trader** than the requirements described in clauses 4 to 7.

Consultation on changes to pricing structures

9 Distributors to consult concerning changes to pricing structures

- (1) A **distributor** must consult with each **trader** trading on the **distributor's embedded network** in respect of the **distributor's** pricing structure for the **consumers** with which the **distributor** does not have a contract in respect of the conveyance of **electricity** before making a change to the pricing structure that materially affects 1 or more **traders** or **consumers**.
- (2) For the purpose of subclause (1), changes to a **distributor's** pricing structure that may materially affect 1 or more **traders** or **consumers** include, but are not limited to, any of the following:
- (a) a change by the **distributor** to the eligibility criteria for 1 or more of the **distributor's** prices;
 - (b) a change by the **distributor** to the **distributor's** pricing structure by the introduction of a new price;
 - (c) a change by the **distributor** to the **distributor's** pricing structure that means that 1 or more of the **distributor's** prices are no longer available.

- (3) However, the fact that a change is listed in subclause (2) does not mean that a **distributor** is required to consult on the change if the change will not materially affect **traders or consumers**.

Provision of information

10 Distributor or trader may require provision of information

- (1) A **distributor** may, by notice in writing, require a **trader** to provide information to the **distributor**, to enable the **distributor** to invoice and reconcile charges for **distribution** services.
- (2) A **trader** may, by notice in writing, require the **distributor** to provide information to the **trader**, to enable the **trader** to invoice and reconcile charges for **distribution** services.
- (3) A **trader** or **distributor** that receives a notice under subclause (1) or subclause (2) must provide the information no later than 15 **business days** (or such other date as agreed between the parties) after receiving the notice.
- (4) Nothing in this clause prevents the **distributor** and the **trader** agreeing to provide **volume information** to each other for a purpose other than to enable invoicing and reconciling of charges for **distribution** services.

Schedule 12A.4

cl 12A.2(1)

Requirements for developing, making available, and amending default distributor agreements

1 Content of this Schedule

This Schedule sets out provisions that apply to each **distributor** described in a row in column 1 below, and each **participant** described in column 2 of the row:

Row	Column 1 – Distributor	Column 2 – Participant
1	Each distributor that owns or operates a local network , and has an interposed arrangement with 1 or more traders trading on the local network	Each trader that is a retailer , and is trading or wishes to trade at an ICP on the network of a distributor described in column 1 of this row

Requirement to have default distributor agreements

2 Distributors must have default distributor agreements

Each **distributor** must have a **default distributor agreement** for each type of arrangement described in clause 1 to which the **distributor** is a party.

3 Content of default distributor agreements

- (1) A **distributor** must ensure that each **default distributor agreement** that it is required to have includes—
 - (a) each **core term** set out in the relevant **default distributor agreement template**; and
 - (b) **operational terms** that meet each of the requirements set out in the relevant **default distributor agreement template**, which are the requirements that are in text boxes and shaded in the **default distributor agreement template**; and
 - (c) **collateral terms** (if any) that the **distributor** proposes to include in each **distributor agreement** that it enters into for the type of arrangement to which the **default distributor agreement** applies; and
 - (d) any terms relating to additional services that the **distributor** intends to require be applied in accordance with clause 7 of Schedule 12A.1.
- (2) A **distributor** may, but is not required to, include in its **default distributor agreement** any term that is described in the relevant **default distributor agreement template** as a **recorded term**, which are in text boxes and shaded in the **default distributor agreement template**.
- (3) A **distributor** must ensure that any **collateral terms** it includes in a **default distributor agreement** under subclause (1)(c) —
 - (a) are clearly identified as **collateral terms** and not **core terms**, **operational terms**, or **recorded terms**; and
 - (b) are not inconsistent with, and do not modify the effect of, any of the following terms:

- (i) **core terms** in the relevant **default distributor agreement** and **default distributor agreement template**; or
 - (ii) **operational terms** in the relevant **default distributor agreement**.
- (4) For the purpose of this Part, the **default distributor agreement template** that applies in respect of each **distributor** described in a row in column 1 below is set out in the appendix described in column 2 of the row:

Row	Column 1 – Distributor	Column 2 – Appendix
1	Each distributor that owns or operates a local network , and has an interposed arrangement with 1 or more traders trading on the local network	Appendix A

Principles and requirements for operational terms

4 Principles for operational terms in default distributor agreements

- (1) This clause sets out principles that must be applied by—
 - (a) each **distributor** when it sets the **operational terms** in a **default distributor agreement**; and
 - (b) the **Rulings Panel** when it reviews 1 or more **operational terms** under clause 8.
- (2) The principles are that a **distributor's operational terms** must—
 - (a) be consistent with the **Authority's** main objective in section 15 of the **Act**; and
 - (b) reflect a fair and reasonable balance between the legitimate interests of the **distributor** and the requirements of the **participant** trading on, connected to, or using the **distributor's network** or equipment connected to the **distributor's network**; and
 - (c) reflect the interests of **consumers** on the **distributor's network**; and reflect the reasonable requirements of all **participants** trading on, connected to, or using the **distributor's network** or equipment connected to the **distributor's network**, and the ability of the **distributor** to meet those requirements.

Schedule 12A.4 clause 4(2)(a): amended, on 1 March 2024, by clause 67 of the Electricity Industry Participation Code Amendment (Code Review Programme) 2024.

5 Requirements for operational terms

- (1) A **distributor** must not include an **operational term** in a **default distributor agreement** that is inconsistent with, or modifies the effect of, any **core term** that the **distributor** must include in the **default distributor agreement**.
- (2) In setting the **operational terms** in a **default distributor agreement**, a **distributor** must apply the principles set out in clause 4(2).

Making default distributor agreements available and consultation

6 Making default distributor agreements available

- (1) Subject to subclause (4), each **distributor** described in a row in column 1 below must make the **default distributor agreement** that applies in respect of the arrangement described in row 1 available on its website from the date specified in column 2:

Row	Column 1 – Distributor	Column 2 – Date
1	Each distributor that owns or operates a local network , and has an interposed arrangement with 1 one or more traders trading on the local network	<p>For Orion New Zealand Limited, Powerco Limited, Unison Networks Limited, Vector Limited, and Wellington Electricity Lines Limited from the day that is 150 days after this Part comes into force</p> <p>For each other distributor that is a distributor on the date that this Part comes into force, from the day that is 210 days after this Part comes into force</p> <p>For each other distributor that became a distributor after the date that this Part comes into force, from the later of the following:</p> <ul style="list-style-type: none"> (i) the day that is 210 days after this Part comes into force; or (ii) 30 business days before the date on which the distributor commences engaging in the business of distribution on the basis described in row 1.

- (2) A **distributor** must, before making a **default distributor agreement** available on its website, consult each **participant** that the **distributor** considers is likely to be affected by the **default distributor agreement**, on the **operational terms** that the **distributor** proposes to include in its **default distributor agreement**.
- (3) A **distributor** must, no later than 2 **business days** after making a **default distributor agreement** available on its website, advise each **participant** described in subclause (2) that the **default distributor agreement** is available on the **distributor's** website.
- (4) A **distributor** may, but is not required to, include any term that is described as a **recorded term** in a **default distributor agreement** made available on its website.

Appeals against operational terms in default distributor agreements

7 Participants may appeal operational terms in default distributor agreements

- (1) A **participant** that participated in consultation under clause 6(2) in respect of a **default distributor agreement** may appeal to the **Rulings Panel** against the inclusion of 1 or more **operational terms** in the **default distributor agreement** by giving notice to the **Rulings Panel** and the relevant **distributor** by the date specified in subclause (2).

- (2) The **participant** must give the notice no later than 40 **business days** after the **distributor** gives notice under clause 6(3) that its **default distributor agreement** is available on its website.

8 Rulings Panel appeal process

- (1) If the **Rulings Panel** receives a notice from a **participant** before the end of the period specified in clause 7, the **Rulings Panel** must, no later than 10 **business days** after receiving the notice, advise the **participant** that the **Rulings Panel** will—
 - (a) review 1 or more of the **operational terms** to which the notice relates; or
 - (b) decline to review 1 or more of any such terms, giving reasons.
- (2) In reviewing an **operational term** in a **default distributor agreement**, the **Rulings Panel** must apply the principles set out in clause 4(2).
- (3) If the **Rulings Panel** reviews an **operational term**, the **Rulings Panel** must, no later than 20 **business days** after advising the **participant** under subclause (1),—
 - (a) confirm the **operational term**; or
 - (b) amend the **operational term**, in which case clauses 9 and 10 apply; or
 - (c) direct the **distributor** to reconsider, either generally or in respect of any specified matter, the **operational term**, within such time as the **Rulings Panel** must specify, and give the **distributor** any such directions as the **Rulings Panel** thinks fit concerning the reconsideration of the **operational term**, in which case clause 11 applies.
- (4) If requested by the **participant** who gave notice under clause 7(1) or the relevant **distributor**, the **Rulings Panel** may make an order as to the **operational terms** that apply on an interim basis until the **Rulings Panel** makes a decision under subclause (3).
- (5) Nothing in this clause permits the **Rulings Panel** to amend an amount that is charged by the **distributor** to the **participant** party to the **default distributor agreement**.

9 Amendments to operational term by Rulings Panel

- (1) This clause applies if the **Rulings Panel** amends 1 or more **operational terms** of a **default distributor agreement** in accordance with clause 8(3)(b).
- (2) Each such **operational term** in the **default distributor agreement** is deemed to be amended accordingly.
- (3) The **distributor** must—
 - (a) make an updated version of the **default distributor agreement** that includes each amended **operational term** available on its website no later than 5 **business days** after the date of the **Rulings Panel's** decision; and
 - (b) advise each **participant** that the **distributor** considers is likely to be affected by the amendment to the **default distributor agreement**, that an updated version of the agreement is available on the **distributor's** website no later than 2 **business days** after making the agreement available on its website.

10 Effect of Rulings Panel amendments to operational term on existing agreements

- (1) If the **Rulings Panel** amends an **operational term** under clause 8(3)(b), the **Rulings Panel** must, at the time that it amends the term, stipulate 1 of the following in respect of each **distributor agreement** that the **distributor** has with a **participant** that includes the **operational term**:

- (a) that the **distributor** or the **participant** may elect to amend their **distributor agreement** to include the amendment by giving notice to the other party:
 - (b) that the **distributor** may elect to amend its **distributor agreement** with the **participant** to include the amendment by giving notice to the **participant**:
 - (c) that the **participant** may elect to amend its **distributor agreement** with the **distributor** by giving notice to the **distributor**.
- (2) The **distributor** or **participant** must give a notice recording its election under subclause (1) no later than 10 **business days** after the date on which the **distributor** advised the **participant** that the updated **default distributor agreement** was available on its website under clause 9(3)(b).
 - (3) If a notice is given by a **distributor** or a **participant** within the timeframe specified in subclause (2), the **distributor agreement** to which the notice relates is deemed to be amended to include the amended **operational term** from the date on which the notice is received by the **distributor** or **participant**.
 - (4) Subclauses (1) to (3) do not apply in respect of any **distributor agreement** that the **distributor** has with a **participant** in which the **operational term** has been amended or omitted.

11 Amendments to operational term by distributor following appeal

- (1) If a **distributor** amends 1 or more **operational terms** of a **default distributor agreement** after being directed to reconsider the term by the **Rulings Panel** under clause 8(3)(c), the **distributor** must—
 - (a) make an updated version of its **default distributor agreement** that reflects the amendment available on its website no later than 5 **business days** after making the amendment; and
 - (b) advise each **participant** that the **distributor** considers is likely to be affected by the amendment to the **default distributor agreement** that an updated version of the agreement is available on the **distributor's** website, no later than 2 **business days** after making the agreement available.
- (2) Clauses 7 and 8 apply (with all necessary modifications) in respect of an amendment to a **default distributor agreement** made under subclause (1).

Amending operational terms in default distributor agreements

12 Amending operational terms in default distributor agreements

- (1) A **distributor** may amend 1 or more **operational terms** of a **default distributor agreement** by making the **default distributor agreement** with the amended **operational terms** available on its website.
- (2) Before a **distributor** amends a **default distributor agreement**, it must consult each **participant** that the **distributor** considers is likely to be affected by the amendment.
- (3) A **distributor** must, no later than 2 **business days** after making a **default distributor agreement** with the amended **operational terms** available on its website, advise each **participant** described in subclause (2) that the **default distributor agreement** with the amended **operational terms** is available on the **distributor's** website.

- (4) Clauses 7 and 8 apply (with all necessary modifications) in respect of an amendment to a **default distributor agreement** made under subclause (1) as if the amendment was a **default distributor agreement**.

13 Effect of amendment to operational terms on existing agreements

- (1) This clause applies in respect of each **distributor agreement** between a **distributor** and a **participant** that came into force before the day on which the **distributor** made an amended **default distributor agreement** available under clause 12 ("existing agreement").
- (2) If an existing agreement includes an **operational term** that is amended in accordance with clause 12, the existing agreement is deemed to be amended accordingly with effect from the 15th **business day** after the date on which the amended **default distributor agreement** was made available under clause 12.

Providing arbitration decisions relating to interpretation of default distributor agreement to the Authority

14 Participants must provide certain arbitration decisions to Authority

- (1) A **participant** who refers a dispute under the **default distributor agreement** to arbitration must give the **Authority** a copy of the arbitration decision to the extent that it relates to the interpretation of the **default distributor agreement** or provisions of the **default distributor agreement**.
- (2) Nothing in this clause requires a **participant** to give the **Authority** any information for which a good reason to refuse to supply **Code information** applies under clause 2.6 as if the information is **Code information**.
- (3) For the purposes of subclause (2), an agreement between the parties to a dispute not to supply information under this clause does not constitute a good reason to refuse to comply with subclause (1).

Schedule 12A.4, Appendix A Sch 12A.4, cl 3(4)
**Default distributor agreement for distributors and traders on local
networks (interposed)**

Default Distributor Agreement

Template

Version: June 2020

Distributor:

[insert full legal name of the Distributor]

TABLE OF CONTENTS

PARTIES	1
COMMENCEMENT DATE	1
SIGNATURES	2
INTRODUCTION	2
PART I – AGREEMENT TERM AND SERVICE COMMITMENTS	2
1. TERM OF AGREEMENT.....	2
2. SUMMARY OF GENERAL OBLIGATIONS	2
3. CONVEYANCE ONLY	3
4. SERVICE INTERRUPTIONS	5
5. LOAD MANAGEMENT	7
6. LOSSES AND LOSS FACTORS.....	9
PART II – PAYMENT OBLIGATIONS	9
7. DISTRIBUTION SERVICES PRICES AND PROCESS FOR CHANGING PRICES ..	9
8. ALLOCATING PRICE CATEGORIES AND PRICE OPTIONS TO ICPS.....	11
9. BILLING INFORMATION AND PAYMENT	14
10. PRUDENTIAL REQUIREMENTS.....	17
PART III – OPERATIONAL REQUIREMENTS.....	22
11. ACCESS TO THE CUSTOMER'S PREMISES	22
12. GENERAL OPERATIONAL REQUIREMENTS	24
13. NETWORK CONNECTION STANDARDS.....	26
14. MOMENTARY FLUCTUATIONS AND POWER QUALITY	27
15. CUSTOMER SERVICE LINES.....	27
16. TREE TRIMMING.....	27
17. CONNECTIONS, DISCONNECTIONS, AND DECOMMISSIONING	28
PART IV – OTHER RIGHTS.....	29
18. BREACHES AND EVENTS OF DEFAULT	29
19. TERMINATION OF AGREEMENT	30
20. CONFIDENTIALITY	32
21. FORCE MAJEURE	33
22. AMENDMENTS TO AGREEMENT	34
23. DISPUTE RESOLUTION PROCEDURE	34
24. LIABILITY.....	35
25. INDEMNITY.....	38
26. CLAIMS UNDER THE DISTRIBUTOR'S INDEMNITY	39
27. FURTHER INDEMNITY.....	39
28. CONDUCT OF CLAIMS.....	40
29. CUSTOMER AGREEMENTS.....	41
30. NOTICES.....	42
31. ELECTRICITY INFORMATION EXCHANGE PROTOCOLS	42
32. MISCELLANEOUS	44
33. INTERPRETATION	44
PART V – SCHEDULES.....	52
SCHEDULE 1 – SERVICE STANDARDS.....	53
SCHEDULE 2 – BILLING INFORMATION	60
SCHEDULE 3 – ELECTRICITY INFORMATION EXCHANGE PROTOCOLS	62
SCHEDULE 4 – SYSTEM EMERGENCY EVENT MANAGEMENT	63
SCHEDULE 5 – SERVICE INTERRUPTION COMMUNICATION REQUIREMENTS.....	64
SCHEDULE 6 – CONNECTION POLICIES	68
SCHEDULE 7 – PRICING.....	73
SCHEDULE 8 – LOAD MANAGEMENT	74

AGREEMENT dated 20[]

PARTIES

Distributor: [insert full legal name of the Distributor and complete the block below]	Trader: [insert full legal name of the Trader and complete the block below]
<p>Distributor's Details:</p> <p>Street Address: [insert]</p> <p>Postal Address: [insert]</p> <p>Address for Notices: [insert]</p> <p>Contact Person's Details:</p> <p>Phone: [insert]</p> <p>Fax: [insert]</p> <p>Website: [insert]</p> <p>Email Address: [insert]</p>	<p>Trader's Details:</p> <p>Street Address: [insert]</p> <p>Postal Address: [insert]</p> <p>Address for Notices: [insert]</p> <p>Contact Person's Details:</p> <p>Phone: [insert]</p> <p>Fax: [insert]</p> <p>Website: [insert]</p> <p>Email Address: [insert]</p>

COMMENCEMENT DATE

[insert date]

SIGNATURES

[Parties can sign the Agreement using the signature block below, but see clause 6 of Schedule 12A.1 of the Code, which provides for the Agreement to apply as a binding contract in certain circumstances]

_____ Signature	_____ Signature
_____ Name of authorised person signing for Distributor	_____ Name of authorised person signing for Trader
_____ Position	_____ Position
_____ Date	_____ Date

INTRODUCTION

- A. The Distributor agrees to provide the Distribution Services to the Trader on the terms and conditions set out in this Agreement.
- B. The Trader agrees to purchase the Distribution Services from the Distributor on the terms and conditions set out in this Agreement.

PART I – AGREEMENT TERM AND SERVICE COMMITMENTS

1. TERM OF AGREEMENT

- 1.1 **Commencement:** This Agreement commences on the date on which it is deemed to commence under Part 12A of the Code (the "**Commencement Date**").
- 1.2 **Termination:** This Agreement continues until it is terminated under clause 19 or otherwise at law.

2. SUMMARY OF GENERAL OBLIGATIONS

- 2.1 **Purpose of clause:** This clause is intended to provide an overview of each party's obligations under this Agreement, and does not impose any legal obligations on either party.
- 2.2 **Summary of Distributor's general obligations:** In summary, this Agreement requires the Distributor to provide Distribution Services to the Trader as follows:
 - (a) deliver electricity to Service Levels specified in any Service Standards set out in Schedule 1;
 - (b) provide service interruption information under clause 4 and Schedule 5;
 - (c) carry out Load Shedding under clause 4.4.

- (d) carry out load control as permitted under clause 5, Schedule 1, and Schedule 8;
- (e) calculate Loss Factors in accordance with clause 6;
- (f) allocate Price Categories to ICPs under clause 8;
- (g) consider applications for new connections and changes to capacity for existing connections, implement disconnections and reconnections and decommission ICPs, under clause 17 and Schedule 6; and
- (h) provide information in accordance with EIEPs under clause 31 and Schedule 3.

2.3 **Summary of Trader's general obligations:** In summary, this Agreement requires the Trader to perform obligations as follows:

- (a) pay for Distribution Services and provide billing information under clause 9 and Schedule 2;
- (b) meet prudential requirements under clause 10;
- (c) provide service interruption information under clause 4 and Schedule 5;
- (d) carry out load control as permitted under clause 5, Schedule 1, and Schedule 8;
- (e) provide information to enable the Distributor to calculate Loss Factors under clause 6;
- (f) select Price Options and, if appropriate, request a new Price Category for an ICP under clause 8;
- (g) process applications for new connections or changes to the capacity of existing connections, and provide information about ICPs to be disconnected, reconnected, or decommissioned, under clause 17 and Schedule 6;
- (h) have a Customer Agreement with each Customer for the supply of electricity that contains terms that meet the requirements of clause 29, including procuring from each Customer:
 - (i) access to Customer's Premises for the Distributor under clause 11;
 - (ii) non-interference and damage undertakings under clause 12;
 - (iii) an undertaking that Customer Installations will comply with the Distributor's Network Connection Standards under clause 13;
 - (iv) acknowledgement of the possible effects of momentary fluctuations under clause 14; and
 - (v) acknowledgement that the Customer is responsible for Customer Service Lines under clause 15 and tree trimming under clause 16; and
- (i) provide information in accordance with EIEPs and respond to requests from the Distributor for Customer information under clause 31 and Schedule 3.

3. CONVEYANCE ONLY

3.1 **Distributor may enter into Direct Customer Agreement with Customer:** The Distributor may enter into a Direct Customer Agreement with a Customer at the Customer's written request, provided that any existing Customer Agreement between the Trader and the Customer is not a fixed term agreement or the fixed term has not expired.

3.2 **Conveyance Only basis:** If a Customer has, or enters into, a Direct Customer Agreement, the Distributor must:

- (a) allow electricity to be conveyed through the Network on a Conveyance Only basis on the applicable terms of this Agreement to allow the Trader to supply electricity to that Customer; and

- (b) for each relevant ICP:
 - (i) in accordance with the requirements of the Code relating to information included in the Registry, update the Registry field that indicates that the Distributor is directly billing the Customer in respect of that ICP; and
 - (ii) within 5 Working Days following the commencement of a Direct Customer Agreement, notify the Trader that a Direct Customer Agreement has been entered into in respect of that ICP.
- 3.3 **Valid Direct Customer Agreement:** The Trader must not knowingly supply electricity on a Conveyance Only basis to an ICP unless there is a valid Direct Customer Agreement in force in relation to the ICP.
- 3.4 **Acting consistently with Direct Customer Agreement:** The Trader must not knowingly do or omit to do anything, or cause any person to do or omit to do anything, that is inconsistent with the obligations of the Customer or the Distributor under any Direct Customer Agreement. However, the technical requirements in a Direct Customer Agreement may differ from the technical requirements in relation to Distribution Services set out in this Agreement, if the Distributor has given the Trader reasonable notice of those requirements.
- 3.5 **Termination of Direct Customer Agreement:** The Trader acknowledges that the Distributor will be entitled to terminate any Direct Customer Agreement in accordance with its terms.
- 3.6 **Co-operate to resolve issues:** Without limiting either party's rights or remedies in respect of any breach of this Agreement, if either of the following issues arises, the Distributor and the Trader must co-operate with each other to try to resolve the issue in a manner that on balance delivers the best outcome for all affected parties (including the Customer) but that does not adversely impact on the integrity of the Network:
 - (a) if, in relation to the supply of electricity to any Customer that is a party to a Direct Customer Agreement, the Distributor notifies the Trader that it considers (acting reasonably) that the Trader has done, or is doing, anything that is inconsistent with the Direct Customer Agreement and that may have an impact on the Network or the provision of Distribution Services by the Distributor to that or any other Customer; or
 - (b) if either the Trader or the Distributor becomes aware that any provisions of a Direct Customer Agreement and any Electricity Only Supply Agreement would conflict to the extent that a party would be in breach of contract.
- 3.7 **Customer not party to valid Direct Customer Agreement:** If at any time it is found that a Customer is not being supplied on an Interposed basis in relation to 1 or more ICPs and is not a party to a valid Direct Customer Agreement in relation to those ICPs, or if any Direct Customer Agreement in relation to particular ICPs expires or is terminated or is about to expire or be terminated, then, without limiting any other right of the Distributor under this Agreement or otherwise:
 - (a) the Distributor may notify the Trader (or any other trader) of the situation and suggest the Trader (or any other trader) take up the opportunity to supply the Customer on an Interposed basis in relation to those ICPs; and
 - (b) if the Distributor gives notice under clause 3.7(a), the Distributor may disconnect the ICPs if, within 20 Working Days of giving that notice, the Distributor has not

received notice that the Trader (or any other trader) will immediately commence supplying the Customer on an Interposed basis in relation to those ICPs.

4. SERVICE INTERRUPTIONS

General

- 4.1 **Communication about Service Interruptions:** The parties must comply with any requirements relating to communication about Service Interruptions set out in Schedule 5.
- 4.2 **Distributor may Publish Service Interruption information:** The Distributor may Publish or disclose to the media or any other person any information relating to any Service Interruption.
- 4.3 **Managing load during System Emergency Event:** The Distributor must manage load on the Network during a System Emergency Event in accordance with the Distributor's System Emergency Event management policy set out in Schedule 4, and the Code.
- 4.4 **Load Shedding:** The Distributor may carry out Load Shedding in the following circumstances:
- (a) **Maintenance of Network equipment:** if the Distributor wishes to inspect or effect alterations, maintenance, repairs, or additions to any part of the Network, subject to clauses 4.6, 4.8, 4.10, and Schedule 5 as applicable;
 - (b) **Permitted by Service Standards:** as permitted by the Service Standards, if the Customer has elected to receive an interruptible or otherwise non-continuous supply of electricity;
 - (c) **Compliance with instructions from the System Operator:**
 - (i) to comply with a request or instruction received from the System Operator in accordance with the Code; or
 - (ii) if communication with the System Operator has been lost, and the Distributor reasonably believes that, had communication with the System Operator been maintained, the Distributor would have received a request or instruction from the System Operator to shed load in accordance with the Code;
 - (d) **Maintain security and safety:** to maintain the security and safety of the Network in order to:
 - (i) maintain a safe environment, consistent with the Distributor's health and safety policies;
 - (ii) prevent unexpected short term overloading of the Network;
 - (iii) prevent voltage levels rising or falling outside of legal requirements;
 - (iv) manage System Security; and
 - (v) avoid or mitigate damage to the Network or any equipment connected to the Network;
 - (e) **Compliance with the Code:** to comply with the Code or the law; or
 - (f) **Other circumstances:** for any other purpose that, in the Distributor's reasonable opinion, and in accordance with Good Electricity Industry Practice, requires the interruption or reduction of delivery of electricity to any ICP.

Unplanned Service Interruptions

- 4.5 **Party responsible for Unplanned Service Interruption calls:** The party responsible for receiving Unplanned Service Interruption calls from Customers and managing

further communication with affected Customers until normal service is restored, as necessary, is identified in Schedule 5.

- 4.6 **Notification of Unplanned Service Interruptions:** If an Unplanned Service Interruption occurs, the Distributor and the Trader must comply with the service interruption communication requirements set out in Schedule 5.
- 4.7 **Customer requests for restoration of Distribution Services:** During any Unplanned Service Interruption, unless the Distributor requests otherwise, the Trader must forward to the Distributor any requests it receives from Customers for the restoration of the Distribution Services as soon as practicable, and the Distributor must acknowledge such receipt unless the Trader requests otherwise.

Planned Service Interruptions

***Requirements for recorded terms:** If the Distributor has any obligations relating to how it schedules Planned Service Interruptions and the impact of Planned Service Interruptions on Customers, insert as clause 4.8 a recorded term that sets out those obligations. If no obligations of that type apply, insert the words "not applicable" as clause 4.8. An example is provided in clause 4.8. Revise as appropriate and then delete this dashed box.*

4.8 **Distributor to schedule Planned Service Interruptions to minimise disruption:** *The Distributor must, as far as is reasonably practicable, schedule Planned Service Interruptions to minimise disruption to Customers.*

4.9 **Responsibility for notification of Planned Service Interruptions:** The party responsible for notifying Customers of a Planned Service Interruption is identified in Schedule 5.

4.10 **Parties to comply with notification requirements:** The Distributor and the Trader must comply with any requirements set out in Schedule 5 in relation to the notification of Planned Service Interruptions.

Restoration of Distribution Services

***Requirements for recorded terms:** If the Distributor has any obligations relating to the duration of service interruptions and/or the timely restoration of Distribution Services following Planned or Unplanned Service Interruptions, insert as clause 4.11 a recorded term that sets out those obligations. If no obligations of that type apply, insert the words "not applicable" as clause 4.11. An example is provided in clause 4.11. Revise as appropriate and then delete this dashed box.*

4.11 **Distributor to restore Distribution Services as soon as practicable:** *In the case of a Service Interruption, the Distributor must endeavour in accordance with Good Electricity Industry Practice to restore the Distribution Services:*

- (a) for Unplanned Service Interruptions, as soon as reasonably practicable and no later than the timeframes set out in Schedule 1; and*
- (b) for Planned Service Interruptions, as soon as reasonably practicable and no later than the timeframe set out in the notice for Planned Service Interruptions sent to the Customer.*

Requirements for recorded terms: *If any remedies are available to the Trader in the event that the Distributor fails to meet any obligations set out in clause 4.11, insert as clause 4.12 a recorded term that either sets out those remedies, or refers to another part of this Agreement where those remedies are set out. If no remedies are available to the Trader, or if the Distributor has no relevant obligations, insert the words "not applicable" as clause 4.12. An example is provided in clause 4.12. Revise as appropriate and then delete this dashed box.*

4.12 Trader's remedy: *Except as provided in clause 9.10, the Trader's only remedy if the Distributor fails to meet the timeframes in clause 4.11 is the payment of a Service Guarantee Payment in accordance with Schedule 1.*

5. LOAD MANAGEMENT

- 5.1 Distributor may control load:** Subject to clause 5.3, the Distributor may control part or all of the Customer's load (as the case may be) in accordance with this clause 5, Schedule 1, and Schedule 8 if:
- (a) the Distributor provides a Price Category or Price Option that allows for a non-continuous level of service in respect of part or all of the Customer's load (a "**Controlled Load Option**"), and charges the Trader on the basis of the Controlled Load Option in respect of the Customer; or
 - (b) the Distributor provides any other service in respect of part or all of the Customer's load advised by the Distributor to the Trader from time to time (an "**Other Load Control Option**") with respect to the Customer (who elects to take up the Other Load Control Option).
- 5.2 Trader may control load:** Subject to clause 5.3, if the Trader offers to a Customer, and the Customer elects to take up, a price option for a non-continuous level of service by allowing the Trader to control part of or all of the Customer's load, the Trader may control part or all of the Customer's load (as the case may be) in accordance with this clause 5 and Schedule 8.
- 5.3 Control of load by Entrant if some load controlled by Incumbent:** If either party (the "**Entrant**") seeks to control part of a Customer's load at a Customer's ICP, but the other party (the "**Incumbent**") has obtained the right to control part of the load at the same ICP in accordance with clause 5.1 or 5.2 (as the case may be), the Entrant may only control the part of the Customer's load that:
- (a) the Customer has agreed the Entrant may control under an agreement with the Entrant; and
 - (b) is separable from, and not already subject to, the Incumbent's right to control part of the Customer's load at the ICP obtained in accordance with clause 5.1 or 5.2 (as the case may be).
- 5.4 No interference with or damage to Incumbent's Load Control System:** The Entrant must ensure that neither it nor its Load Control System interferes with the proper functioning of, or causes damage to, the Incumbent's Load Control System.
- 5.5 Remedy if interference or damage:** If the Entrant or any part of the Entrant's Load Control System interferes with, or causes damage to, any part of the Incumbent's Load Control System, the Entrant must, on receiving notice from the Incumbent or on becoming aware of the situation, promptly and at its own cost remove the source of the interference and make good any damage.

- 5.6 **Trader to make controllable load available to Distributor for management of system security:** If the Trader has obtained the right to control part of any Customer's load in accordance with clause 5.2, the Trader must:
- (a) within 5 Working Days of having first obtained such a right, notify the Distributor that the Trader has obtained the right;
 - (b) unless the Distributor agrees otherwise, and within 60 Working Days of providing the notice under paragraph (a), develop and agree jointly with the Distributor (such agreement not to be unreasonably withheld by either party), a protocol to be used by the parties to this Agreement that:
 - (i) is consistent with the Distributor's System Emergency Event management policy set out in Schedule 4, and the Code;
 - (ii) is for the purpose of coordinating the Trader's controllable load with other emergency response activities undertaken by the Distributor during a System Emergency Event, such purpose having priority during a System Emergency Event over other purposes for which the load might be controlled;
 - (iii) assists the Distributor to comply with requests and instructions issued by the System Operator when managing System Security in accordance with the Code during a System Emergency Event; and
 - (iv) assists the Distributor to manage Network system security during a System Emergency Event;
 - (c) during a System Emergency Event, operate its controllable load in accordance with the protocol developed in accordance with paragraph (b); and
 - (d) at all times, operate its controllable load as a reasonable and prudent operator in accordance with Good Electricity Industry Practice.

Requirements for recorded terms: *If the Distributor and/or the Trader have any obligations to maintain load control equipment, insert as clause 5.7 a recorded term setting out those obligations. If no obligations of that type apply, insert the words "not applicable" as clause 5.7. An example is provided in clause 5.7. Revise as appropriate and then delete this dashed box.*

5.7 **Maintenance of Load Control Equipment:** *A party providing Load Control Equipment must endeavour in accordance with Good Electricity Industry Practice to ensure that the Load Control Equipment:*

- (a) *receives and responds to the appropriate load control signals;*
- (b) *properly controls the appropriate load; and*
- (c) *is otherwise fit for purpose.*

Requirements for recorded terms: *If the Distributor and/or the Trader have any obligations to maintain load signalling equipment, insert as clause 5.8 a recorded term setting out those obligations. If no obligations of that type apply, insert the words "not applicable" as clause 5.8. An example is provided in clause 5.8. Revise as appropriate and then delete this dashed box.*

5.8 **Maintenance of Load Signalling Equipment:** *A party providing Load Signalling Equipment must endeavour in accordance with Good Electricity Industry Practice to ensure that the Load Signalling Equipment:*

- (a) *sends appropriate load control signals that are capable of being reliably received by all associated Load Control Equipment; and*

(b) is otherwise fit for purpose.

6. LOSSES AND LOSS FACTORS

- 6.1 Information to enable calculation of Loss Factors:** The Distributor may obtain information from the reconciliation manager for the purpose of calculating Loss Factors unless that information is provided by the Trader. The Trader must provide the Distributor with any additional information that the Distributor may reasonably require to enable the Distributor to calculate Loss Factors within 15 Working Days of the request from the Distributor.
- 6.2 Calculation of Loss Factors:** The Distributor must calculate Loss Factors in accordance with the requirements of the Code relating to Loss Factors (if any).
- 6.3 Change of Loss Factors:** If the Distributor wishes to change 1 or more Loss Category codes or Loss Factors, the Distributor must give the Trader at least 40 Working Days' notice of the proposed change (including the reasons for the proposed change).
- 6.4 Transparent Loss Factors methodology:** A notice provided to the Trader in accordance with clause 6.3 must include details of the methodology and information used by the Distributor to determine the Loss Factors.
- 6.5 Complaints about Loss Factors:** If, at any time, the Trader considers that 1 or more Loss Factors notified by the Distributor are not appropriate, or that the methodology or information used to calculate the Loss Factor is incorrect, the Trader may make a written complaint to the Distributor. The Distributor must consider the complaint in good faith, and may change the Loss Factors declared in its notice to reflect the Trader's concerns in accordance with clause 6.3. The Distributor must decide whether to make the change and, if applicable, give notice under clause 6.3, no later than 20 Working Days after receipt of the complaint.
- 6.6 Disputes about Loss Factors:** If the Distributor does not change its notice after having received a complaint from the Trader, the Trader may raise a Dispute with the Distributor for the Loss Factors to be determined in accordance with the Dispute resolution process in clause 23. If the outcome of the Dispute is that the Distributor changes the Loss Factors declared in the Distributor's notice, and the change leads to a change in the level of revenue received by the Distributor, the Distributor may determine the time from which the change is to apply, which must be no later than 60 Working Days from the date on which the Dispute is finally resolved.

PART II – PAYMENT OBLIGATIONS

7. DISTRIBUTION SERVICES PRICES AND PROCESS FOR CHANGING PRICES

- 7.1 Distribution Services pricing information:** Schedule 7 sets out information about how the Trader can access information about the Distributor's:
- (a) Pricing Structure;
 - (b) Price Categories;
 - (c) Price Options (if any); and
 - (d) Prices.

The Distributor must ensure that the information it makes available in accordance with Schedule 7 is available in a standard, downloadable electronic document format in a form that permits electronic search and copy functions.

7.2 **Changes to Pricing Structure, Price Categories, Price Options, and Prices:** The Distributor may change:

- (a) its Prices as set out in clauses 7.3 to 7.7; and
- (b) its Pricing Structure as set out in clauses 7.4, 7.6, and 7.7; and
- (c) its Price Categories and Price Options (if any) at any time, provided that the change does not have the effect of increasing 1 or more Prices,

Requirements for recorded terms: *If any restrictions apply to the Distributor's ability to increase its prices, insert as clause 7.3 a recorded term that sets out those restrictions. If no restrictions apply, insert the words "not applicable" as clause 7.3. An example is provided in clause 7.3. Revise as appropriate and then delete this dashed box.*

7.3 **Price changes:** *Unless otherwise agreed with the Trader, the Distributor may not change its Prices more than [once in any period of 12 consecutive months], unless a change is a material increase to 1 or more existing Prices and results from a change in:*

- (a) *a cost that is a pass-through cost or a recoverable cost specified in a determination of an input methodology by the Commerce Commission under Part 4 of the Commerce Act 1986 in respect of the services provided by the Distributor;*
- (b) *the Distributor providing new Distribution Services or materially changing existing Distribution Services, provided that any proposed Price change must only apply to ICPs affected by the new or changed Distribution Services; or*
- (c) *the law.*

Nothing in this clause prevents the Distributor from decreasing a Price at any time, or from increasing a Price with the agreement of the Trader.

7.4 **Process to change Pricing Structure:** If the Distributor intends to make a change to its Pricing Structure that will materially affect the Trader or 1 or more Customers, the Distributor must first consult with the Trader about the proposed change. If appropriate, the Distributor may consult jointly with the Trader and all other traders that are affected by the proposed change. Without limiting anything in clause 7.3, and unless the parties agree otherwise, the Distributor must:

- (a) **comply with the Code:** comply with any provisions in the Code relating to the pricing of Distribution Services; and
- (b) **notify Trader of final Pricing Structure:** provide the Trader with information about the final Pricing Structure and the reasons for the Distributor's decision, in a manner that clearly sets out the change made, at least 40 Working Days before the change comes into effect.

7.5 **Notice of Price changes:** In addition to any notification requirements under clause 7.4, if the Distributor makes or intends to make a Price change, the Distributor must:

- (a) give the Trader at least 40 Working Days' notice of the Price change, unless the Distributor is required by law to implement the Price change earlier, in which case the Distributor must give as much notice as is reasonably practicable;
- (b) if the Price change will result in an ICP or a group of ICPs being allocated to a different Price Category, without limiting clause 8, the Distributor must give the Trader a mapping table that clearly shows:

- (i) the new Price Category to which each affected ICP or group of ICPs is to be allocated; and
- (ii) the Price Category that applied to each affected ICP or group of ICPs before the change was made; and
- (c) if the Price change is in respect of ICPs that have either a category 1 or category 2 metering installation, the Distributor must notify the Trader of the Price change in accordance with EIEP12.

7.6 Pricing Structure and Price change disputes: Once a change to a Pricing Structure has been finalised in accordance with clause 7.4, or a Price change is notified in accordance with clause 7.5, the Trader may raise a Dispute under clause 23 in respect of the Pricing Structure or the Price change only if the Trader considers that the Distributor has not complied with clause 7.4 or 7.5 (as the case may be). If a Dispute is raised, the Trader must continue to pay the Distributor's Tax Invoices until the Dispute is resolved.

7.7 Changes containing an error: If the Trader identifies an error in the Pricing Structure finalised and notified in accordance with clause 7.4, or an error in a Price change notified in accordance with clause 7.5 that arises from an obvious error in applying the Pricing Structure, the Trader must bring that error to the Distributor's attention as soon as practicable after becoming aware of the error. The Distributor may correct an error, including an error that it identifies itself, without following the process under clause 7.4 or giving notice under clause 7.5(a) (as the case may be), provided that the correction of the error must not have a material effect on the Trader or 1 or more Customers. To avoid doubt, the correction of an error in accordance with this clause is not a Price change for the purposes of clause 7.2.

8. ALLOCATING PRICE CATEGORIES AND PRICE OPTIONS TO ICPs

8.1 Distributor allocates Price Category: The Distributor must:

- (a) allocate a Price Category to each ICP on its Network; and
- (b) change the Price Category allocated to an ICP on its Network if necessary because the attributes of the ICP have changed.

8.2 Allocation of Price Categories if more than 1 option: If there are 2 or more Price Categories within the Distributor's Pricing Structure for which an ICP is eligible, the Distributor must allocate 1 of the eligible Price Categories to the ICP.

8.3 Matters to have regard to in allocating Price Category: In allocating a Price Category to an ICP or changing the Price Category allocated to an ICP, the Distributor must have regard to the following:

- (a) the eligibility criteria for each Price Category referred to in Schedule 7;
- (b) the attributes of the ICP; and
- (c) if known and relevant:
 - (i) the Trader's or Customer's preference for a particular Price Category in respect of which the ICP is eligible;
 - (ii) the meter register configuration(s) of the Metering Equipment and any Load Control Equipment installed for the ICP, which may determine the Price Option or Price Options that apply if more than 1 Price Option is defined for the relevant Price Category;
 - (iii) the ICP's historic demand profile;
 - (iv) the Customer's capacity requirements; and

(v) any other factors.

- 8.4 **Trader may request allocation of an alternative eligible Price Category:** At any time, the Trader may request that the Distributor allocate an alternative Price Category to an ICP, and must provide any information necessary to support its request. If the Distributor, acting reasonably, agrees that the ICP meets the eligibility criteria for the requested alternative Price Category, the Distributor must apply the change (but not retrospectively, unless it agrees otherwise) and advise its decision to the Trader within 5 Working Days (or such longer period as agreed between the Distributor and the Trader) after receipt of notice of the Trader's request. If the Distributor declines the request, it must provide the reasons for its decision.
- 8.5 **Trader to select Price Option to match meter register configuration:** If the Distributor provides options within a Price Category that correspond to alternative eligible meter register configurations ("**Price Options**"), the Trader must:
- (a) select the Price Option that corresponds to the configuration of each meter register installed at the relevant ICP;
 - (b) notify the Distributor of that selection in accordance with the relevant EIEP; and
 - (c) if the meter register configuration for the ICP changes, change the Price Option to match the new configuration and notify the Distributor of the change in accordance with the relevant EIEP.
- 8.6 **Trader request for reallocation of Price Category if it considers Price Category has been Incorrectly Allocated:** Under this clause 8.6 and clauses 8.7 and 8.9, a Price Category is "**Incorrectly Allocated**" to an ICP only if the ICP was ineligible for the Price Category allocated by the Distributor based on the relevant information available to the Distributor at the time it made the allocation. If the Trader reasonably considers that a Price Category was Incorrectly Allocated to an ICP, the Trader must notify the Distributor of the reasons why it considers that the Price Category was Incorrectly Allocated and identify the Price Category that the Trader considers should have been allocated to the ICP, which must be a Price Category for which the ICP is eligible. The Distributor must advise the Trader within 10 Working Days after receipt of the Trader's notice whether it agrees to allocate the requested Price Category (the "**Corrected Price Category**") to the ICP, such agreement not to be unreasonably withheld, and must provide the reasons for its decision. To avoid doubt, this clause 8.6 does not apply if the Distributor has already provided notice to the Trader that the relevant Price Category is Incorrectly Allocated under clause 8.9.
- 8.7 **Credit following correction:** If the Distributor allocates a Corrected Price Category to an ICP following notice from the Trader given under clause 8.6, the Distributor must:
- (a) commence charging the Trader in accordance with the Price(s) that applies to the Corrected Price Category with immediate effect; and
 - (b) subject to clause 8.8, and by issuing a Credit Note payable in the next monthly billing cycle, credit the Trader with an amount (if positive) equivalent to:
 - (i) the charges paid by the Trader in respect of that ICP in the period from the later of:
 - (A) the Commencement Date;
 - (B) the date the Distributor Incorrectly Allocated the Price Category to that ICP; and
 - (C) the Switch Event Date for that ICP recorded for the Trader,

up to the date on which the Distributor allocates a Corrected Price Category to that ICP; less

- (ii) the charges that would have applied if the Corrected Price Category had been allocated to that ICP during the period referred to in subparagraph (i), provided that the maximum period for which credit will be payable under this clause 8.7 is 15 months, unless otherwise agreed.

8.8 **Limitations on credits for Price Category corrections:** Clause 8.7(b) does not apply in respect of an ICP if:

- (a) clause 8.9 applies to the ICP; or
- (b) within 20 Working Days of the Switch Event Date recorded for the Trader, the Trader has not provided the Distributor with correct or complete information about the ICP or the Customer necessary to determine Price Category eligibility (provided that information was not already known by the Distributor);
- (c) the Price Category correction was necessary because the Trader provided the Distributor with incorrect or incomplete information in relation to the ICP or the Customer or any other factors in respect of that ICP that were relevant to the allocation of a Price Category; or
- (d) the initial Price Category was allocated on the basis of incorrect information provided by the Customer or the Customer's representative.

8.9 **Distributor's right to change Price Category if it considers Price Category has been Incorrectly Allocated:** If at any time the Distributor reasonably considers that a Price Category has been Incorrectly Allocated to an ICP:

- (a) the Distributor must notify the Trader accordingly, including notification of the reasons why it considers that the Price Category has been Incorrectly Allocated, and identify the Price Category or Price Categories it considers the ICP is eligible for;
- (b) unless the Trader is able to provide evidence to the Distributor's reasonable satisfaction within 10 Working Days of the Distributor's notice that the current Price Category has not been Incorrectly Allocated, the Distributor may:
 - (i) allocate the Price Category that it considers appropriate to that ICP (acting reasonably and consistently with clause 8.1), and
 - (ii) commence charging the Trader for Distribution Services in accordance with that Price Category after a further 40 Working Days; and
- (c) the Distributor must provide to the Trader information relevant to its decision.

8.10 **Application of clause 8.9:** Clause 8.9 does not apply if the Trader has already provided notice to the Distributor under clause 8.6 that the relevant Price Category has been Incorrectly Allocated.

8.11 **Commencement of charges:** The Trader is liable to pay charges in respect of an ICP from:

- (a) the day the ICP is Energised or Re-energised; or
- (b) if the Trader is assuming responsibility for the ICP, the later of the Switch Event Date or the date that the ICP is Energised.

8.12 **Cessation of charges:** The Trader is not liable to pay charges in respect of an ICP:

- (a) from the day on which an ICP is De-energised (except as a result of a Temporary Disconnection); or
- (b) from the Switch Event Date, if another trader takes responsibility for the ICP; or

- (c) from the day which is 2 Working Days after the Distributor receives a notification from the Trader that the Distributor is responsible for completing a Vacant Site Disconnection in respect of the ICP in accordance with Schedule 6.

9. BILLING INFORMATION AND PAYMENT

- 9.1 **Calculating Tax Invoices for Distribution Service charges:** The Trader must provide information to enable the Distributor to calculate Distribution Services charges and prepare Tax Invoices, in accordance with Schedule 2.
- 9.2 **Late, incomplete, or incorrect information:** If the Trader does not provide information to the Distributor in accordance with Schedule 2 by the 5th Working Day after the last day of the month to which the Tax Invoice relates, or any information provided by the Trader is incomplete or materially incorrect, the Distributor may estimate, in accordance with Good Electricity Industry Practice, the Trader's Tax Invoice for Distribution Services.
- 9.3 **Issuing of Tax Invoices:** The Distributor must issue Tax Invoices for Distribution Services as follows:
 - (a) the Distributor must invoice the Trader within 10 Working Days after the last day of the month to which the Tax Invoice relates;
 - (b) a Tax Invoice may either be:
 - (i) calculated based on the information provided by the Trader in accordance with Schedule 2 (an "**Actual Invoice**"); or
 - (ii) estimated in accordance with Good Electricity Industry Practice, including where clause 9.2 applies (a "**Pro forma Invoice**");
 - (c) at the same time as it provides an Actual Invoice (under paragraph (a), (d), or (e)), the Distributor must provide to the Trader, in accordance with the relevant EIEP, sufficiently detailed information to enable the Trader to verify the accuracy of the Tax Invoice;
 - (d) if late, incomplete, or incorrect information is provided and the Tax Invoice is a Pro forma Invoice on the basis of that information, the Distributor must issue an Actual Invoice that replaces the Pro forma Invoice in the month after it receives additional or revised consumption information, at the same time as the Distributor issues a Tax Invoice to the Trader for its Distribution Services charges for that month;
 - (e) if the Tax Invoice is a Pro forma Invoice and paragraph (d) does not apply, the Distributor must, by no later than the same time as the Distributor issues a Tax Invoice under paragraph (a) to the Trader for its Distribution Services charges for the following month, issue an Actual Invoice that replaces the Pro forma Invoice as well as a Credit Note in relation to the Pro forma Invoice;
 - (f) if the information received by the Distributor in accordance with Schedule 2 includes revised reconciliation information or additional consumption information, the Distributor must provide a separate Credit Note or Debit Note to the Trader in respect of the revised consumption information ("**Revision Invoice**"), and a Use of Money Adjustment (unless the parties agree otherwise);
 - (g) if a Revision Invoice is required, the Distributor must issue the Revision Invoice in the month after the Distributor receives the revised reconciliation information

- or additional consumption information, at the same time as the Distributor issues a Tax Invoice to the Trader for its Distribution Services charges for that month; and
- (h) at the same time it provides a Revision Invoice, the Distributor must provide to the Trader, in accordance with the relevant EIEP, sufficiently detailed information to enable the Trader to verify the accuracy of the Revision Invoice.

9.4 **Due date for payment:** The settlement date for each Tax Invoice issued by the Distributor must be the 20th day of the month in which the Tax Invoice is received, or if the 20th day of the month is not a Working Day, the first Working Day after the 20th day. However, if the Distributor fails to send a Tax Invoice to the Trader within 10 Working Days after the last day of the month to which the Tax Invoice relates, the due date for payment is extended by 1 Working Day for each Working Day that the Tax Invoice is late.

Requirements for recorded terms: If the Distributor or the Trader is entitled to issue any other invoices under this Agreement, insert as clause 9.5 a recorded term setting out the process for issuing those invoices (including any relevant timeframes for issuing those invoices and the settlement date for those invoices). If neither the Trader nor the Distributor is entitled to issue any other invoices under this Agreement, insert the words "not applicable" as clause 9.5. An example is provided in clause 9.5. Revise as appropriate and then delete this dashed box.

9.5 **Other invoices:**

- (a) *The Distributor may issue the Trader with:*
- (i) *a Tax Invoice for payment for any other sums due to the Distributor under this Agreement; and*
 - (ii) *a Credit Note for payment of Service Guarantee Payments due to the Trader.*
- (b) *The Trader may issue the Distributor with a Tax Invoice for Service Guarantee Payments and any other sums due to the Trader under this Agreement.*
- (c) *Any Tax Invoice or Credit Note issued under clause 9.5(a) or (b) must be issued within 10 Working Days of the end of the month to which the Tax Invoice or Credit Note relates.*
- (d) *The settlement date for any Tax Invoice issued under clause 9.5(a) or (b) is the 20th day of the month in which the Tax Invoice is received or, if the 20th day of the month is not a Working Day, the first Working Day after the 20th day. If the Distributor or the Trader (as the case may be) fails to send a Tax Invoice to the Trader or the Distributor (as the case may be) within 10 Working Days after the last day of the month to which the Tax Invoice relates, the due date for payment is extended by 1 Working Day for each Working Day that the Tax Invoice is late.*

9.6 **Interest on late payment:** Subject to clause 9.7, the Trader or the Distributor (as the case may be) must pay any Tax Invoice issued under this clause 9. If any part of a Tax Invoice that is properly due in accordance with this Agreement is not paid by the due date, Default Interest may be charged on the outstanding amount for the period that the Tax Invoice remains unpaid.

9.7 **Disputed invoices:** If the Trader or the Distributor disputes a Tax Invoice (which includes a Revision Invoice) issued under this clause 9, the party disputing the invoice ("**Disputing Party**") must notify the other party ("**Non-disputing Party**") in writing and provide details as to the reasons why the Disputing Party disputes that invoice

within 18 months of the date of the first Tax Invoice issued in respect of the Distribution Services charges the subject of the disputed Tax Invoice ("**Invoice Dispute**"). On receiving an Invoice Dispute notice, the Non-disputing Party must:

- (a) if the Non-disputing Party agrees with the matters set out in the Invoice Dispute notice and:
 - (i) the Disputing Party has not paid the disputed Tax Invoice, promptly issue a Credit Note for the disputed amount, and any remaining amount owed must be paid by the Disputing Party within 6 Working Days of receipt of the Credit Note, but need not pay prior to the time set out in clause 9.4 or 9.5; or
 - (ii) the Disputing Party has paid the disputed invoice, calculate the amount that the Disputing Party has over paid and promptly issue a Credit Note to the Disputing Party for the amount over paid, which must include a Use of Money Adjustment. Any amount owed must be paid by the Non-disputing Party within 6 Working Days of issuing the Credit Note. A Use of Money Adjustment must apply for the period commencing on the date the original Tax Invoice was paid and ending when re-payment is made, but the amount need not be settled prior to the time set out in clauses 9.4 or 9.5; or
- (b) if the Non-disputing Party disagrees with the matters set out in the Invoice Dispute notice, either party may raise a Dispute in accordance with clause 23 and if the Disputing Party has not paid the disputed Tax Invoice, it must pay the undisputed amount of the disputed Tax Invoice issued in accordance with clauses 9.4 or 9.5; and
- (c) on the resolution of a Dispute under clause 23, any amount owed must be paid by the relevant party within 6 Working Days. Default Interest is payable for the period commencing on the date the disputed amount would have been due for payment under this clause 9, and ending when payment is made. To the extent the Tax Invoice is held not to be payable, the Non-disputing Party must issue a Credit Note to the Disputing Party.

9.8 **Incorrect invoices:** If it is found that a party has been overcharged or undercharged, and the party has paid the Tax Invoice (which includes a Revision Invoice) containing the overcharge or undercharge, within 20 Working Days after the error has been discovered and the amount has been agreed between the parties, the party that has been overpaid must refund to the other party the amount of any such overcharge or the party that has underpaid must pay to the other party the amount of any such undercharge, in both cases together with a Use of Money Adjustment on the overcharged or undercharged amount, provided that neither party has the right to receive a compensating payment in respect of an overcharge or undercharge if more than 18 months has elapsed since the date of the Tax Invoice containing the overcharge or undercharge.

9.9 **No set-off:** Both parties must make the payments required to be made to the other under this Agreement in full without deduction of any nature whether by way of set-off, counterclaim or otherwise except as otherwise set out in clause 9.7 or as may be required by law.

Requirements for recorded terms: *If the Trader or a Customer is entitled to a refund in the event of a continuous interruption affecting a Customer, insert as clause 9.10 a recorded term setting out that entitlement, including how the refund will be calculated. If the Trader and/or*

an affected Customer are not entitled to a refund in the event of a continuous interruption, insert the words "not applicable" as clause 9.10. An example is provided in Clause 9.10. Revise as appropriate and then delete this dashed box.

9.10 Refund of charges: *If, as a consequence of a fault on the Network, there is a continuous interruption affecting a Customer's Point of Connection for 24 hours or longer, the Distributor must issue a Credit Note and refund, in the next monthly billing cycle, for the Distribution Services charges paid by the Trader in respect of the ICP or ICPs for that Customer for the number of complete days during which supply was interrupted, provided that the Trader requests that the Distributor refund such charges no later than 60 days after the interruption.*

10. PRUDENTIAL REQUIREMENTS

10.1 Distributor may require Trader to comply with prudential requirements: The Distributor may, by giving notice to the Trader, require the Trader to comply with prudential requirements, in which case the Trader must, whether the notice is received before or after the commencement of this Agreement, comply with prudential requirements as follows:

- (a) if the Trader is not trading on the Network, the Trader must comply with prudential requirements before the Trader starts trading on the Network; and
- (b) if the Trader is trading on the Network, the Trader must comply with prudential requirements within 10 Working Days after receipt of the Distributor's notice.

10.2 Trader elects prudential requirements: If the Distributor requires the Trader to comply with prudential requirements in accordance with clause 10.1, the Trader must comply with either of the following prudential requirements:

- (a) the Trader must maintain an acceptable credit rating at all times; or
- (b) the Trader must provide and maintain at all times acceptable security by, at the Trader's election:
 - (i) providing the Distributor with a cash deposit of the value specified in clause 10.6 ("**Cash Deposit**"), which the Distributor must hold in a trust account that the Distributor must establish and operate in accordance with clause 10.26;
 - (ii) arranging for a third party with an acceptable credit rating to provide security in a form acceptable to the Distributor, of the value specified in clause 10.6; or
 - (iii) providing a combination of the securities listed in subparagraphs (i) and (ii) to the value specified in clause 10.6.

10.3 Acceptable credit rating: For the purposes of clause 10.2, an acceptable credit rating means that the Trader or the third party (as the case may be):

- (a) carries a long term credit rating of at least:
 - (i) Baa3 (Moody's Investor Services Inc.);
 - (ii) BBB- (Standard & Poor's Rating Group);
 - (iii) B- (AM Best); or
 - (iv) BBB- (Fitch Ratings); and
- (b) if the Trader or the third party (as the case may be) carries a credit rating at the minimum level required by paragraph (a), is not subject to a negative watch or any similar arrangement by the agency that gave it the credit rating.

- 10.4 **Change in prudential requirements complied with:** The Trader may elect to change the way in which it complies with prudential requirements by notifying the Distributor of the change at least 2 Working Days before the change occurring, in which case the parties must comply with clause 10.18. The change will come into effect on the intended date, provided that the Trader has complied with all its obligations under this Agreement, and on confirmation, satisfactory to the Distributor, that an alternative suitable form of security has been provided that satisfies the requirements of clause 10.2.
- 10.5 **Evidence of acceptable credit rating:** The Trader or third party (as the case may be) must provide such evidence that it has maintained or is maintaining an acceptable credit rating as the Distributor or its agent may from time to time reasonably require.
- 10.6 **Value of security:** The value of security required for the purposes of this clause 10 is the Distributor's reasonable estimate of the Distribution Services charges that the Trader will be required to pay to the Distributor in respect of any period of not more than 2 weeks, notified in writing by the Distributor to the Trader. If additional security is required in accordance with clause 10.7 ("**Additional Security**"), the Distributor's notice provided under clause 10.1 must state the amount of the Additional Security.
- 10.7 **Distributor may require Additional Security:** The Distributor may, by notice to the Trader, require the Trader to provide Additional Security. The amount of any Additional Security required must be such that the total value of all security required to be provided by the Trader under this Agreement is not more than the Distributor's reasonable estimate of the charges that the Trader will be required to pay to the Distributor under this Agreement in respect of any 2 month period.
- 10.8 **If Additional Security required:** If the Distributor requires the Trader to provide Additional Security:
- (a) the Trader may elect the type of security that it provides in accordance with clause 10.2(b); and
 - (b) the parties must comply with clauses 10.16 and 10.18.
- 10.9 **Additional Security requirements:** The following provisions apply in respect of any Additional Security provided:
- (a) if the Additional Security is in the form of a Cash Deposit, the Distributor must pay a charge to the Trader for each day that the Distributor holds the Additional Security at a per annum rate that is calculated as follows:

the Bank Bill Yield Rate for that day, plus 15 percentage points

(so that, by way of example, if the Bank Bill Yield Rate for the relevant day is 3%, the charge will be 18%)
 - (b) the parties agree that the charge calculated in accordance with paragraph (a) is a genuine and reasonable pre-estimate of the cost to the Trader of providing the Additional Security in the form of a Cash Deposit;
 - (c) the Additional Security must be held as if it were part of the Cash Deposit under this Agreement;
 - (d) if the Additional Security is in the form of security from a third party, the Distributor must pay a charge to the Trader for each day that the Distributor holds

the Additional Security at a per annum rate of 3% on the amount of Additional Security held on that day;

- (e) any money required to be paid by the Distributor to the Trader in accordance with this clause 10.9 must be paid by the Distributor to the Trader on a quarterly basis; and
- (f) if the Trader provides an amount that is greater than the amount of Additional Security required by the Distributor as Additional Security, the charges set out in paragraph (a) will not be payable by the Distributor in relation to the amount provided in excess of the Additional Security required by the Distributor.

10.10 Estimating the value of security if the Trader is a new trader: If the Trader has not previously entered into a contract with the Distributor for access to the Network, the Distributor must estimate the value of security required under clause 10.6 for the first 6 months of this Agreement, subject to any reassessment of the value under this Agreement, having regard to:

- (a) the Distributor's historical records of the Distribution Service charges in respect of the relevant ICPs; or
- (b) in the absence of such records, a bona fide business plan prepared by the Trader in good faith is necessary for the Distributor to determine the value of security that it requires from the Trader.

10.11 Review of the value of security: The Distributor may review, or the Trader may require the Distributor to review, the value of security required to be provided by the Trader at any time.

10.12 Trader to notify Distributor of changes affecting security: Subject to clause 10.14, the Trader must immediately notify the Distributor if any of the following occurs:

- (a) the Trader no longer carries an acceptable credit rating; or
- (b) the Trader has complied with prudential requirements by arranging for a third party to provide security in accordance with clause 10.2(b), and the Trader learns that the third party no longer carries an acceptable credit rating; or
- (c) the Trader has reasonable cause to believe that its financial position is likely to be materially adversely impaired such that its ability to pay for Distribution Services will be affected.

10.13 Confidential Information: Any information provided by the Trader to the Distributor under clause 10.12 will be Confidential Information.

10.14 Public issuers and listed companies: For the purpose of clause 10.12, if the Trader (or its ultimate parent company) is a "listed issuer" for the purposes of the Financial Markets Conduct Act 2013, the Trader may require the Distributor to enter into a confidentiality and/or security trading prohibition agreement on terms reasonably satisfactory to the Trader before giving notice and disclosing information under clause 10.13, if and for so long as the Trader considers such information to be "inside information" as defined in that Act.

10.15 Distributor may make enquiries: If the Distributor believes that the Trader should have given notice under clause 10.12 and the Distributor has not received any such notice, the Distributor may enquire of the Trader as to whether it should have given such notice. Any such enquiry must be in writing and be addressed to the Chief Executive of the Trader. If notice should have been given, the Trader must give notice immediately, or if no notice is required, the Trader must respond to the Distributor in

writing within 2 Working Days of receipt of the Distributor's notice under this clause 10.15. Correspondence sent or received by either party under this clause is Confidential Information.

10.16 Change to value of security: If:

- (a) the Distributor requires that the Trader provide Additional Security in accordance with clause 10.7; or
- (b) following a review of the Trader's security in accordance with clause 10.11; or
- (c) on receipt of information contemplated by clause 10.12 or 10.15; or
- (d) as the result of a failure by the Trader to respond to a request made under clause 10.15 within the timeframe set out in clause 10.15;

the Distributor or the Trader considers that the value of security should be increased or decreased, the Distributor must, acting reasonably, make a decision on what the value of security should be, and immediately notify the Trader of its decision and the grounds for that decision and must include in the notification details of the part of the security that constitutes Additional Security. To avoid doubt, failure by a Trader to respond to a request made under clause 10.15 within the required timeframe constitutes reasonable grounds for a Distributor to change the value of security required to be provided by the Trader.

10.17 Failure to maintain acceptable credit rating: If:

- (a) on receipt of information contemplated by clauses 10.12 or 10.15; or
- (b) as the result of a failure by the Trader to respond to a request made under clause 10.15 within the timeframe set out in clause 10.15,

the Distributor considers, acting reasonably, that the Trader is no longer able to maintain an acceptable credit rating in accordance with clause 10.2(a), and the Distributor still requires the Trader to comply with prudential requirements, the Distributor must notify the Trader of the value of acceptable security required in accordance with clause 10.2(b).

10.18 Distributor or Trader to effect changes in value or type of security: The Distributor or the Trader, as appropriate, must take all actions necessary to satisfy the requirement for the increase or decrease in the value of security or change to the type of security, within 5 Working Days of notification under clause 10.4, 10.16, or 10.17. Refunds of Cash Deposits and reductions of the value of third party security required must be made in accordance with clauses 10.19 or 10.21.

10.19 Refund of Cash Deposit: If the Distributor refunds all or part of a Cash Deposit, it must refund all or part of the Cash Deposit into a bank account nominated by the Trader on the Working Day following the day on which the Distributor decided to, or is required to, refund the Cash Deposit.

10.20 Cash Deposit on Insolvency Event: If an Insolvency Event occurs in relation to the Trader:

- (a) the Trader will not be entitled to a return of the Cash Deposit, other than as set out in clause 10.26(f); and
- (b) if the Trader fails or has failed to pay an amount owing under this Agreement, full beneficial ownership of that amount (plus Default Interest) of the Cash Deposit (or if the Cash Deposit is less than the amount owing, the full amount of the Cash Deposit) will automatically transfer solely to the Distributor and the Distributor

will be entitled to draw down that amount (plus Default Interest), on 2 Working Days' notice to the Trader.

10.21 Reduction of third party security: If the Distributor decreases the value of third party security required in accordance with this Agreement, the Trader may arrange for the issuing of new third party security for the lesser value, in satisfaction of clause 10.2(b)(ii), which will replace the earlier third party security.

10.22 When Distributor may make a call on security: The Distributor may make a call on security in accordance with clause 10.23 if:

- (a) the Trader has provided security for the purpose of clause 10.2(b); and
- (b) the Trader fails to pay an amount due under this Agreement; and
- (c) the amount is not subject to a genuine dispute.

10.23 Calls on security: If this clause applies in accordance with clause 10.22, the Distributor may, on 2 Working Days' notice to the Trader (or immediately in the case of deemed Cash Deposit under clause 10.25), call on the security as follows:

- (a) if the Trader provided a Cash Deposit (which includes a deemed Cash Deposit), full beneficial ownership of the amount owing (plus Default Interest) of the Cash Deposit will automatically transfer solely to the Distributor effective from the expiry of the 2 Working Day notice period or immediately (as applicable) and the Distributor may draw down and apply the amount owed (including Default Interest) from the Cash Deposit;
- (b) if the Trader arranged for a third party to provide security, the Distributor may call on the provider of a third party security to pay the amount owed in accordance with the security; and
- (c) in either case, the Distributor must immediately notify the Trader that it has called on the security.

10.24 Requirement to maintain security: To avoid doubt, if the Distributor draws down some or all of a Cash Deposit held by the Distributor under this Agreement, or calls on the provider of a third party security, the Trader must within 5 Working Days take all steps necessary to ensure that the Trader maintains acceptable security of the value specified in clause 10.6 and the value of any Additional Security required by clause 10.7 (as such may be reviewed by the Distributor in accordance with clause 10.11), as required by clause 10.2(b).

10.25 Third party security may be released: If the provider of third party security makes a payment to the Distributor in order to be released from its obligations under that security, such payment will be deemed to constitute a Cash Deposit provided by the Trader in substitution for the third party security and must be dealt with in accordance with clause 10.26.

10.26 Trust Account Rules: If the Distributor receives a Cash Deposit:

- (a) the Cash Deposit must be held in a trust account in the name of the Trader, to be applied or distributed only on the terms of this Agreement, or as otherwise agreed by the parties;
- (b) the Distributor must establish a trust account with a New Zealand registered bank ("**the Bank**") for the purpose of holding the Cash Deposit ("**Trust Account**");
- (c) the Distributor must obtain acknowledgement from the Bank that the Cash Deposit is held on trust in the Trust Account and that the Bank has no right of set-off or right of combination in relation to the Cash Deposit;

- (d) the Trader must inform the Distributor of the bank(s) that the Trader uses for its banking purposes and if the Trader changes banks;
- (e) the Trust Account must bear interest at the best on call rate reasonably available from time to time from the Bank. The Distributor must pay the Trader the interest earned on the Cash Deposit (except for the amount of the Cash Deposit that is Additional Security, in respect of which a charge should be paid in accordance with clause 10.9) on a quarterly basis net of account fees and any amounts required to be withheld by law, unless the parties agree otherwise;
- (f) if this Agreement is terminated, the Distributor must refund any Cash Deposit (less any amount owed to the Distributor plus any interest not yet paid to the Trader) to the Trader in accordance with clause 10.19, provided that the Trader:
 - (i) is not otherwise in default of this Agreement;
 - (ii) has ceased to be bound by this Agreement; and
 - (iii) has discharged all obligations under this Agreement to the Distributor, including payment of all outstanding amounts under this Agreement; and
- (g) the Distributor must provide the Trader with an annual report in respect of the operation of the Trust Account if requested by the Trader.

10.27 Release of third party security: If this Agreement is terminated, the Distributor must release any third party security, provided that the Trader has met all of the requirements set out in clause 10.26(f).

PART III – OPERATIONAL REQUIREMENTS

11. ACCESS TO THE CUSTOMER'S PREMISES

- 11.1 Rights of entry onto Customer's Premises:** The Trader must, subject to clause 29.1, include in each of its Customer Agreements a requirement that the Customer provide the Distributor and its agents with safe and unobstructed access onto the Customer's Premises for all of the following purposes:
- (a) to inspect, maintain, operate, or upgrade (provided that the upgrade does not have any material adverse effect on the relevant Customer or Customer's Premises) the Distributor's Equipment;
 - (b) to install, read, maintain, or upgrade (provided that the upgrade does not have any material adverse effect on the relevant Customer or Customer's Premises) Metering Equipment that is owned by the Distributor;
 - (c) to Energise, Re-energise, disconnect, and reconnect the Customer in accordance with this Agreement;
 - (d) to access the Trader's Equipment to verify metering information, including, in the event of termination of this Agreement, to determine any charges outstanding at the time of termination;
 - (e) for the safety of persons or property;
 - (f) to ensure that the Customer fulfils its obligations in accordance with clause 12.7;
 - (g) to enable the Distributor to gain access to and remove any of the Distributor's Equipment following the termination of the Customer Agreement for the period ending 6 months after the date that termination takes effect; and
 - (h) to comply with the law in relation to the provision of Distribution Services.

- 11.2 **Exercise of access rights:** In exercising its access rights under clause 11.1, the Distributor must, except to the extent that the Distributor has any other binding agreement setting out its access rights directly with the Customer:
- (a) comply with sections 23A to 23D, 57, and 159 of the Electricity Act 1992 as though these sections relate to the Distributor's access rights as contemplated under clause 11.1, provided that the Distributor must give written notice to a Customer if the Distributor intends to access the Customer's Premises for any reason (except if the Distributor requires access to carry out a routine inspection or operation of the Distributor's Equipment, or in an emergency situation);
 - (b) ensure that it has appropriate procedures in place for the secure storage, use, and return of any key to and any security information about the Customer's Premises;
 - (c) cause as little disturbance or inconvenience as practicable to the Trader and the Customer (including minimising any direct impact on the Customer's property) and ensure that its personnel:
 - (i) behave in a courteous, considerate, and professional manner at all times while on the Customer's Premises;
 - (ii) carry identification that shows they are authorised personnel of the Distributor; and
 - (iii) if practicable, identify themselves to the Customer before entering the Customer's property; and
 - (iv) comply with the Customer's reasonable requirements, practices, and procedures as disclosed by the Customer or as generally practised for health and safety, and security requirements.
- 11.3 **Distributor may disconnect:** The Trader must, subject to clause 29.1, include in its Customer Agreement a provision to the effect that if the Customer breaches the provisions of its Customer Agreement that require it to give the Distributor access to the Distributor's Equipment on the Customer's Premises, and the breach is material or persistent, the Distributor may disconnect the Customer's ICP from the Network and access the Customer's Premises to reclaim the Distributor's Equipment, provided that:
- (a) if access was required for a purpose described in clause 11.1(a), (b), (d), or (g), the Distributor or Trader gave the Customer 10 Working Days' notice of access being required (if access is required for a purpose described in clause 11.1(c), (e), or (f), such notice is not required); and
 - (b) if access is required for a purpose described in clause 11.1(h), the Distributor or Trader gave the Customer 10 Working Days' notice of access being required (unless the period of notice is specified under the relevant law, in which case the notice period specified under the relevant law applies); and
 - (c) if the disconnection is a Temporary Disconnection, the Distributor has complied with the relevant provisions of Schedule 6.
- 11.4 **Costs of disconnection:** The Distributor will not be liable for any loss the Trader may suffer or incur as a result of a disconnection carried out because the Customer has not given the Distributor access in accordance with the relevant Customer Agreement. The Trader must reimburse the Distributor for all of the Distributor's reasonable costs incurred in relation to the disconnection and any reconnection.
- 11.5 **Existing agreement will prevail:** In the event of a conflict between clause 11 and any provision of any existing agreement between the Customer and Distributor with respect

to the Distributor's access rights to the Customer's Premises, the provisions of the existing agreement between the Distributor and Customer will prevail to the extent of such conflict.

12. GENERAL OPERATIONAL REQUIREMENTS

- 12.1 Interference or damage to Distributor's Equipment by Customers:** The Trader must, subject to clause 29.1, include in each of its Customer Agreements a requirement that, during the term of the Customer Agreement and until the end of the period ending on the earlier of 6 months after the termination of the Customer Agreement or the date on which a new Customer Agreement is entered into in respect of the relevant ICP, the Customer must not interfere with or damage, and must ensure that its agents and invitees do not interfere with or damage, the Distributor's Equipment without the prior written consent of the Distributor (except to the extent that emergency action has to be taken to protect the health or safety of persons or to prevent damage to property).
- 12.2 Costs of making good any damage:** The Trader must, subject to clause 29.1, include in each of its Customer Agreements a requirement that, if any of the Distributor's Equipment is damaged by the negligence or wilful act or omission of the Customer or the Customer's agents or invitees, the Customer must pay the cost of making good the damage to the Distributor.
- 12.3 Interference or damage to Distributor's Equipment or Network by Trader:** The Trader must ensure that it and its employees, agents, and invitees do not interfere with or damage the Distributor's Equipment or Network (including, without limitation, for a period of 6 months after termination of this Agreement) without the prior written consent of the Distributor (except to the extent that emergency action has to be taken to protect the health or safety of persons or to prevent damage to property).
- 12.4 Costs of making good any damage:** If any of the Distributor's Equipment is damaged by the negligence or wilful act or omission of the Trader or the Trader's employees, agents, or invitees, the Trader must pay the cost of making good the damage to the Distributor.
- 12.5 Interference or damage to Trader's Equipment or Customer's Installations:** The Distributor must ensure that it and its employees, agents and invitees do not interfere with or damage the Trader's Equipment or the Customer's Installation (including, without limitation, for a period of 6 months after termination of this Agreement) without the prior written consent of the Trader or the Customer (as the case may be) (except to the extent that emergency action has to be taken to protect the health or safety of persons or to prevent damage to property).
- 12.6 Costs of making good any damage:** If the Trader's Equipment or the Customer's Installation is damaged by the negligence or wilful act or omission of the Distributor or the Distributor's employees, agents, or invitees, the Distributor must pay the cost of making good the damage to the Trader or the Customer (as the case may be). This clause 12.6 is for the benefit of the Customer and may be enforced by the Customer under the Contract and Commercial Law Act 2017. This clause may be varied by agreement between the parties without the consent of any Customer.
- 12.7 Interference with Network:** The Trader must, subject to clause 29.1, include in each of its Customer Agreements a provision to the effect that the Customer must not:

- (a) inject or attempt to inject any electricity into the Network, unless the Customer is also a Distributed Generator and there is a Connection Contract in place between the Distributed Generator and the Distributor; or
 - (b) without the prior written agreement of the Distributor, convey or receive or attempt to convey or receive any signal or other form of communication or any other thing (other than electricity in accordance with this Agreement and load control signals transmitted by or with the written consent of the Distributor) over the Network or cause or permit any other person to do so.
- 12.8 **Connection of Distributed Generation:** The Distributor and the Trader must comply with their obligations under Part 6 of the Code, in respect of connecting Distributed Generation. The Trader must:
- (a) purchase electricity from Distributed Generation connected to the Network only if the Trader has confirmation from the Distributor that there is a Connection Contract in place between the Distributed Generator and the Distributor; and
 - (b) notify the Distributor if the Trader has reasonable grounds to suspect that a Distributed Generator does not have a Connection Contract with the Distributor and has connected its Distributed Generation directly or indirectly to the Network.
- 12.9 **Changes to GXPs:** The following procedure will apply if the Distributor proposes to construct and operate, or agree with a Grid Owner to have constructed and operated, a new GXP, or permanently disconnect the Network from a GXP (a "**Proposal**");
- (a) the Distributor must give the Trader notice of the following:
 - (i) the ICPs, groups of ICPs, or geographical area(s) that will be affected by the Proposal; and
 - (ii) an estimate of the overall costs of the Proposal and a description of any benefits of the Proposal;
 - (b) the Distributor must consult with the Trader about the Proposal for a reasonable period of time; and
 - (c) if, at the conclusion of the consultation, the Distributor decides to proceed with the Proposal (including the Proposal as changed as a result of the consultation), the Distributor must give the Trader at least 20 Working Days' notice of the date on which the commissioning of a new GXP, or permanent disconnection of the Network from a GXP, is expected to be complete.
- 12.10 **Notification of interference, damage, or theft:** If the Distributor or Trader discovers any interference or damage to the other party's equipment or the Customer's Installation, or evidence of theft of electricity, loss of electricity, or interference with the Network, the discovering party must notify the affected party as soon as it is practicable to do so.
- 12.11 **Additional Metering Equipment:** Either party may, at its own cost, install and maintain additional Metering Equipment (whether owned by that party or by a third party) for metering data verification purposes or other purposes, provided that it complies with Part 10 of the Code and:
- (a) the additional Metering Equipment does not interfere with any other equipment owned or used by the other party; and
 - (b) the party installing the additional Metering Equipment ensures that it is installed and maintained in accordance with Good Electricity Industry Practice.

- 12.12 **Responsibility for damages:** If the party installing or maintaining additional Metering Equipment (the "**First Party**") causes damage to the equipment or invalidates the existing Metering Equipment certification of the other party, the First Party must:
- (a) meet the cost of making good the damage or recertifying the Metering Equipment (including the cost of any fines or penalties imposed under the Code as a result of the damage or invalidation of certification); and
 - (b) if the damage invalidates the existing Metering Equipment certification, and the other party incurs costs because of its use of the Metering Equipment during the period of non-certification, the First Party must reimburse the other party for those costs, except to the extent that the indemnified party knew or ought reasonably to have known that the Metering Equipment was uncertified.

Nothing in this clause affects any rights or obligations that a party has under Part 10 of the Code or any other law.

- 12.13 **Safe Housing of Equipment:** The Trader must, subject to clause 29.1, include in each of its Customer Agreements (subject to any written agreement between the Trader and the Distributor) an undertaking by the Customer to provide and maintain, at no cost to the Distributor, suitable space for the safe and secure housing of any of the Distributor's Equipment relating primarily to the connection to the Network of Points of Connection at the Customer's Premises that the Distributor determines is necessary.

- 12.14 **The Network:** The Trader must, subject to clause 29.1, include in each of its Customer Agreements an acknowledgement by the Customer that:

- (a) the Network, including any part of the Network situated on Customer's Premises, is and will remain the sole property of the Distributor; and
- (b) no provision of the Customer Agreement nor the provision of any services by the Distributor in relation to the Network will confer on the Customer or any other person any right of property or other interest in or to any part of the Network or any Distributor's Equipment that is used to provide any such services.

13. NETWORK CONNECTION STANDARDS

- 13.1 **Access to standards:** The Distributor must advise the Trader how the Trader and Customers can access the current version of the Distributor's Network Connection Standards.

- 13.2 **Provisions in Customer Agreements:** The Trader must:

- (a) subject to clause 29.1, include in each of its Customer Agreements an undertaking that the Customer must ensure that the Customer Installation complies at all times with Network Connection Standards and all relevant legal requirements; and
- (b) include in each of its Customer Agreements a statement advising how the Customer can access the current version of the Distributor's Network Connection Standards.

- 13.3 **Notification of non-complying Installation:** If the Trader becomes aware that a Customer's Installation does not comply with the Network Connection Standards, the Trader must notify the Distributor of the ICP identifier of the Customer's Installation and the details of the non-compliance as soon as practicable after becoming aware of the non-compliance. The Distributor must promptly investigate the non-compliance and keep the Trader informed of the actions taken to resolve the non-compliance.

14. MOMENTARY FLUCTUATIONS AND POWER QUALITY

14.1 **Provisions in Customer Agreements:** Subject to clause 29.1, the Trader must:

- (a) include in each of its Customer Agreements an acknowledgement that the Customer recognises that surges or spikes:
 - (i) are momentary fluctuations in voltage or frequency that can occur at any time;
 - (ii) may cause damage to the Customer's sensitive equipment; and

Requirements for recorded terms: Insert as clause 14.1(a)(iii) a recorded term that specifies whether, in the acknowledgements by Customers that the Trader must include in each of its Customer Agreements, surges or spikes are to be treated as interruptions. An example is provided in clause 14.1(a)(iii). Revise as appropriate and then delete this dashed box.

(iii) are not treated as interruptions; and

- (b) advise each of its Customers of the steps the Customer should take to protect their sensitive equipment from such surges or spikes, or inform the Customer of where to find information about the steps the Customer should take.

Requirements for recorded terms: If the Distributor has any obligations in the event that a Customer or the Trader, on behalf of a Customer, raises a concern with the Distributor regarding power quality, insert as clause 14.2 a recorded term setting out those obligations. If no such obligations apply, insert the words "not applicable" as clause 14.2. An example is provided in clause 14.2. Revise as appropriate and then delete this dashed box.

14.2 Customer concerns about power quality: If a Customer, or the Trader on behalf of a Customer, raises a concern with the Distributor regarding the power quality (i.e. frequency or voltage), reliability or safety of the Customer's supply, the Distributor must investigate the concern and advise the Customer of the results of the investigation.

15. CUSTOMER SERVICE LINES

15.1 **Responsibility for Customer Service Lines:** The Trader must, subject to clause 29.1, include in each of its Customer Agreements a statement to the effect that it is the Customer's responsibility to maintain the Customer Service Lines in a safe condition using a suitably qualified person, except if, and to the extent that, the Distributor:

- (a) is required by law to provide and maintain the Customer Service Lines; or
- (b) has agreed with the Customer to maintain the Customer Service Lines.

16. TREE TRIMMING

16.1 **Customer Agreements to provide Customer is responsible for tree trimming:**

Subject to any written agreement between a Customer and the Distributor, and any statutory provision, the Trader must ensure that each of its Customer Agreements provides that the Customer must comply with its obligations under the Electricity (Hazards from Trees) Regulations 2003 in respect of any trees that the Customer has an interest in that are near any line that forms part of the Network.

16.2 **Distributor obligations:** The Distributor must comply with the Electricity (Hazards from Trees) Regulations 2003.

17. CONNECTIONS, DISCONNECTIONS, AND DECOMMISSIONING

- 17.1 Policies and procedures:** The Distributor and the Trader must comply with the provisions of this clause and the policies and procedures set out in Schedule 6 and the relevant provisions of the Code in respect of carrying out:
- (a) new connections to the Network;
 - (b) capacity changes to existing connections;
 - (c) Temporary Disconnections and associated reconnections;
 - (d) Vacant Site Disconnections and associated reconnections;
 - (e) Decommissioning; and
 - (f) connections that incorporate Unmetered Load.
- 17.2 Information exchange:** When exchanging information related to a Network connection, the Distributor and Trader must comply with the relevant EIEPs set out in Schedule 3.
- 17.3 Warranted Persons:** The Distributor and Trader must each ensure that any person that it engages to carry out any activity related to Energising, De-energising, and Decommissioning an ICP that requires work on the Network, or performing any other work on the Network, is a Warranted Person.
- 17.4 Medically dependent and vulnerable Customers:** The Distributor and the Trader must comply with the requirements of the Code relating to medically dependent Customers or vulnerable Customers (if any).
- 17.5 Unmetered Load:** If the Network includes 1 or more ICPs across which Unmetered Load is shared for which the Trader is responsible:
- (a) the Trader must provide information about each such ICP to the Registry in accordance with the requirements specified in the Code; and
 - (b) the Distributor must:
 - (i) maintain a database of all such ICPs that includes all information necessary to support the Registry;
 - (ii) if the Distributor becomes aware of any change to any Unmetered Load, update the database and the Registry and notify the Trader of those changes in accordance with the Code; and
 - (iii) if the Trader notifies the Distributor that Unmetered Load is shared between 2 or more ICPs, and if requested by the Trader, allocate the Unmetered Load to the appropriate ICP and advise the Trader, and all other affected traders, of the allocation in accordance with the Code; and
 - (c) the Trader and the Distributor must align their processes and populate the Registry, including in particular the format of Unmetered Load data populated in the Registry, in accordance with the requirements of the Code relating to unmetered load management (if any).
- 17.6 Decommissioning subject to continuance of supply obligations:** The parties acknowledge that the Distributor's right to Decommission an ICP is subject to subpart 3 of Part 4 of the Act.

PART IV – OTHER RIGHTS

18. BREACHES AND EVENTS OF DEFAULT

- 18.1 **Breach of Agreement:** Subject to clause 18.6, if either party (the "**Defaulting Party**") fails to comply with any of its obligations under this Agreement, the other party may notify the Defaulting Party that it is in breach of this Agreement. The Defaulting Party must remedy a breach within the following timeframe:
- (a) in the case of a Serious Financial Breach by the Trader, within 2 Working Days of the date of receipt of such notice; or
 - (b) in any other case, within 5 Working Days of the date of receipt of such notice.
- 18.2 **Distributor may exercise other remedies for Serious Financial Breaches:** If the Trader has provided acceptable security in accordance with clause 10.2(b), and the Trader has committed a Serious Financial Breach of the type described in paragraph (a) or paragraph (b) of the definition of Serious Financial Breach, the Distributor may give notice to the Trader under clause 18.1 and a notification under clause 18.4, but only if:
- (a) the value of the acceptable security is less than the amount required to remedy the Serious Financial Breach; or
 - (b) the Trader has arranged for a third party to provide acceptable security in accordance with clause 10.2(b)(ii) or (iii), and the Distributor has called on the third party to make payment in accordance with clause 10.23(b), and the third party has failed to do so within 2 Working Days after receiving notice from the Distributor to do so.
- 18.3 **Failure to remedy breach is Event of Default:** If the Defaulting Party fails to remedy the breach within the relevant timeframe set out in clause 18.1:
- (a) the breach is an Event of Default for the purposes of this Agreement;
 - (b) the other party must use reasonable endeavours to speak with the Chief Executive or another senior executive of the Defaulting Party in relation to the Event of Default, and to notify him or her of the other party's intention to exercise its rights under this clause 18; and
 - (c) the Defaulting Party must continue to do all things necessary to remedy the breach as soon as practicable.
- 18.4 **Options for certain Events of Default:** If the Event of Default is any of the following:
- (a) a Serious Financial Breach (in the case of the Trader only);
 - (b) a material breach of the Defaulting Party's obligations under this Agreement that is not in the process of being remedied to the reasonable satisfaction of the other party; or
 - (c) the Defaulting Party has failed on at least 2 previous occasions within the last 12 months to meet an obligation under this Agreement within the time specified and has received notice of such failures from the other party in accordance with clause 18.1 and, whether each individual failure is in itself material or not, if all such failures taken cumulatively materially adversely affect the other party's rights or the other party's ability to carry out its obligations under this Agreement or, if the Defaulting Party is the Trader, the Distributor's ability to carry out its obligations under any agreement with any other electricity trader,
- then no earlier than 1 Working Day after the end of the timeframe set out in clause 18.1, the other party may do any 1 or more of the following:

- (d) issue a notice of termination in accordance with clause 19.2;
- (e) if the Defaulting Party is the Trader, the Distributor may issue a notice prohibiting the Trader from trading at any ICPs on the Distributor's Network at which the Trader was not already trading on the date of the notice;
- (f) exercise any other legal rights available to it; and
- (g) if the breach is a Serious Financial Breach by the Trader, the Distributor may notify the Electricity Authority and/or the clearing manager that clause 14.41(h) of the Code applies.

18.5 **Breaches that are not Events of Default:** If a breach is not an Event of Default, the non-breaching party may:

- (a) refer the matter to Dispute resolution in accordance with clause 23 no earlier than 1 Working Day after the end of the timeframe set out in clause 18.1; and
- (b) exercise any other legal rights available to it.

18.6 **Insolvency Event:** Despite clause 18.1, if either party is subject to an Insolvency Event, the other party may:

- (a) immediately issue a notice of termination in accordance with clause 19.2;
- (b) exercise any other legal rights available to it; and
- (c) if the Insolvency Event involves a Serious Financial Breach by the Trader, the Distributor may notify the Electricity Authority and/or the clearing manager that clause 14.41(h) of the Code applies.

19. TERMINATION OF AGREEMENT

19.1 **Termination:** In addition to any other termination right in this Agreement, a party may terminate this Agreement as set out below:

- (a) **Termination by agreement:** both parties may agree to terminate this Agreement;
- (b) **Dispute resolution:** either party may terminate this Agreement in accordance with any agreement reached or determination made as a result of the Dispute resolution process set out in clause 23 if the other party has committed a breach that (in the case of the Trader) is not a Serious Financial Breach;
- (c) **Illegality:** either party may terminate this Agreement 1 Working Day after notice is given by either party to the other party terminating this Agreement for the reason that performance of any material provision of this Agreement by either party has to a material extent become illegal and the parties acting reasonably agree that despite the operation of clause 32.4 it is not practicable for this Agreement to continue;
- (d) **Termination by Trader if Trader not supplying electricity on Network:** the Trader may terminate this Agreement by giving 5 Working Days' notice to the Distributor if the Trader is not supplying electricity to any Customer through the Network;
- (e) **Termination by Distributor if Trader not supplying electricity on Network:** the Distributor may terminate this Agreement by giving 5 Working Days' notice following any continuous period of 180 Working Days or more during which the Trader has not supplied any Customers with electricity through the Network; or
- (f) **Force majeure:** either party may terminate this Agreement by giving 10 Working Days' notice to the other party, if:

- (i) notice of a Force Majeure Event is given by either party to the other under clause 21.3; and
 - (ii) the Force Majeure Event is of such magnitude or duration that it is impracticable or unreasonable for the party giving notice of termination to remain bound by its obligations under this agreement, provided that if the party who wishes to terminate this agreement is the party that gave notice of the Force Majeure Event, the party has complied with clauses 21.3 and 21.4.
- 19.2 **Termination for Event of Default or Insolvency Event:** In addition to any other termination right in this Agreement, if a party has breached this Agreement and the breach is an Event of Default of any of the types described in clause 18.4(a)-(c), or a party has become subject to an Insolvency Event, the other party may (immediately in the case of an Insolvency Event, and not less than 1 Working Day after the end of the timeframe set out in clause 18.1 in the case of an Event of Default) issue a notice of termination to the defaulting party, effective either:
- (a) no less than 5 Working Days after the date of such notice; or
 - (b) immediately if the Trader has ceased to supply electricity to all Customers.
- 19.3 **Extending effective date of notice of termination:** A party that has given a notice under clause 19.2 may give a notice extending the date on which the notice given under clause 19.2 takes effect.
- 19.4 **Notice of termination lapses:** A notice of termination given under clause 19.2 will lapse if the defaulting party remedies the Event of Default or Insolvency Event (as applicable) prior to the notice of termination becoming effective or the other party withdraws the effective date of its notice.
- 19.5 **Termination not to prejudice rights:** Termination of this agreement by either party will be without prejudice to all other rights or remedies of either party, and all rights of that party accrued as at the date of termination.
- 19.6 **Trader remains liable for charges for remaining Customers:** If this Agreement is terminated for any reason, the Trader remains liable to pay any charges for Distribution Services that arise in relation to connected Customers that have not been switched to another trader, or whose ICPs have not been disconnected by the Distributor (unless the Distributor has received notice to disconnect the ICPs and has not done so, in which case the Trader will not be liable to pay any charges for Distribution Services in respect of the ICP from the date that is 2 Working Days after the date the Distributor received the notice to disconnect the ICP). The Distributor may charge for such Distribution Services at the prices that apply at the time of termination.
- 19.7 **Obligations to continue until termination:** The parties must continue to meet their responsibilities under this Agreement up to the effective date of termination.
- 19.8 **Events to occur on and from termination:** If this Agreement is terminated:
- (a) on the effective date of termination, the parties must have returned or certified the destruction of the other party's Confidential Information; and
 - (b) from the effective date of termination, both parties must co-operate to transfer the Trader's Customers to another trader as soon as possible after the date of termination so that the Trader ceases to trade on the Network.
- 19.9 **Survival of terms:** Any terms of this Agreement that by their nature extend beyond its expiration or termination remain in effect until fulfilled.

20. CONFIDENTIALITY

20.1 **Commitment to preserve confidentiality:** Each party to this Agreement undertakes that it will:

- (a) preserve the confidentiality of, and will not directly or indirectly reveal, report, publish, transfer, or disclose any Confidential Information provided to it by the other party except as provided for in clause 20.2; and
- (b) only use Confidential Information provided to it by the other party for:
 - (i) the purposes of performing its obligations or exercising its rights under this Agreement (subject to any restrictions on the use of the information set out in this Agreement); and
 - (ii) any other purposes expressly permitted by this Agreement or agreed by the parties.

20.2 **Disclosure of Confidential Information:** Either party may disclose Confidential Information in any of the following circumstances:

- (a) **By agreement in writing:** if the Trader and Distributor agree in writing to the disclosure of the information;
- (b) **Provided in this Agreement:** if disclosure is expressly provided for under the terms of this Agreement;
- (c) **Public domain:** if at the time of receipt by the party the Confidential Information is in the public domain or if, after the time of receipt by either party, the Confidential Information enters the public domain (except where it does so as a result of a breach by either party of its obligations under this clause 20 or a breach by any other person of that person's obligation of confidence);
- (d) **Required to disclose:** if either party is required to disclose Confidential Information by:
 - (i) law, or by any statutory or regulatory body or authority; or
 - (ii) any judicial or other arbitration process; or
 - (iii) the regulations of any stock exchange on which the share capital of either party is from time to time listed or dealt in;
- (e) **To employees, directors, agents, or advisors:** if the Confidential Information is disclosed to an employee, director, agent, or advisor of the party, provided that:
 - (i) the information is disseminated only on a "need to know" basis;
 - (ii) recipients of the Confidential Information must be made fully aware of the party's obligations of confidence in relation to the information; and
 - (iii) any copies of the information clearly identify it as Confidential Information;
- (f) **To bona fide potential purchaser:** if the Confidential Information is disclosed to a bona fide potential purchaser of the business or any part of the business of the Distributor or the Trader, subject to that bona fide potential purchaser having signed a confidentiality agreement enforceable by the other party in a form that reflects the obligations in the agreement; and
- (g) **To Customer:** if the Confidential Information relates to a Customer, and the Customer has requested the information.

20.3 **Limit for breach:** A party's liability for breach of this clause 20 will not be limited by clause 24.

20.4 **Unauthorised disclosure:** To avoid doubt, a party will be responsible for any unauthorised disclosure of Confidential Information made by that party's employees,

directors, agents, or advisors and by a bona fide potential purchaser to whom Confidential Information has been disclosed by that party under clause 20.2(f).

- 20.5 **Customer information received in error:** Each party undertakes and agrees that if it or anyone acting on its behalf receives any information (including consumption data) directly or indirectly from the other party in error, it will:
- (a) promptly notify the other party in writing of the receipt of such information;
 - (b) keep such information confidential;
 - (c) not use that information for any purpose; and
 - (d) promptly return the information to the other party or destroy the information upon request by the other party.

The parties acknowledge and agree that this clause 20.5 is for the benefit of all other traders on the Network and may be enforced by any of those other traders under the Contract and Commercial Law Act 2017. This clause 20.5 may be varied by agreement between the parties without the consent of any of those other traders.

21. FORCE MAJEURE

21.1 **Force Majeure Event:** A Force Majeure Event occurs if:

- (a) a party fails to comply with or observe any provision of this Agreement (other than payment of any amount due);
- (b) such failure is caused by:
 - (i) any event or circumstance occasioned by, or in consequence of, any natural disaster, being an event or circumstance:
 - (A) due to natural causes, directly or indirectly and exclusively without human intervention; and
 - (B) that could not have reasonably been foreseen or, if foreseen, could not reasonably have been resisted;
 - (ii) strikes, lockouts, other industrial disturbances, acts of public enemy, wars, terrorism, blockades, insurrections, riots, epidemics, aircraft or civil disturbances;
 - (iii) the binding order or requirement of any court, any government, any local authority, the Rulings Panel, the Electricity Authority, or the System Operator, which the party could not reasonably have avoided;
 - (iv) the partial or entire failure of supply or availability of electricity to the Network; or
 - (v) any other event or circumstance beyond the control of the party invoking this clause 21.1; and
- (c) the failure did not occur because the party invoking this clause failed to act in accordance with Good Electricity Industry Practice.

21.2 **No liability:** A Force Majeure Event will not give rise to any cause of action or liability based on default of the provision that the party has failed to comply with or observe due to the Force Majeure Event.

21.3 **Notice:** If a party becomes aware that a Force Majeure Event may occur or has occurred, it must:

- (a) notify the other party as soon as practicable that it is invoking this clause;
- (b) provide the full particulars of the potential or actual Force Majeure Event; and
- (c) provide ongoing updates until the Force Majeure Event is resolved (if applicable).

- 21.4 **Avoidance and mitigation of effect of Force Majeure Event:** The party invoking clause 21.1 must:
- (a) use all reasonable endeavours to avoid or overcome the Force Majeure Event;
 - (b) use all reasonable endeavours to mitigate the effects or the consequences of the Force Majeure Event; and
 - (c) consult with the other party on the performance of the obligations referred to in paragraphs (a) and (b).
- 21.5 **No obligation to settle:** Nothing in clause 21.4(a) is to be construed as requiring a party to settle a strike, lockout or other industrial disturbance by acceding, against its judgement, to the demands of opposing parties.

22. AMENDMENTS TO AGREEMENT

- 22.1 **Changing this Agreement:** A change may be made to this Agreement:
- (a) by the written agreement of the parties;
 - (b) by the Distributor, if the change is a change to the information referred to in Schedule 7 and is made in accordance with clause 7;
 - (c) by either party if the change is required by law, by the party that considers the change is required giving notice to the other party of the change, the reason for the change, and the date on which the change will take effect. If a party does not agree that a change proposed is required by law, it may raise a dispute in accordance with clause 23; or
 - (d) by either party if the subject matter of the change is regulated by the Commerce Commission and the change is permitted or required as a result of a determination, decision, or direction of the Commerce Commission.

23. DISPUTE RESOLUTION PROCEDURE

- 23.1 **Internal dispute resolution processes:** The parties intend that, if possible, any differences between them concerning this Agreement will be resolved amicably by good faith discussion. When a difference or dispute arises in relation to this Agreement, including any question concerning its existence, validity, interpretation, performance, breach, or termination ("**Dispute**"), the party claiming the existence of a Dispute may provide notice describing such Dispute to the other party. If notice is provided, representatives of the parties must promptly meet to attempt to resolve the Dispute. Where the Dispute is not resolved by discussion between the parties within 15 Working Days of such notice being given, the matter is to be referred to the Chief Executives (or a person nominated by the Chief Executive) of the parties for resolution.
- 23.2 **Right to refer dispute to mediation:** If the Dispute cannot be resolved by the Chief Executives within 15 Working Days of the matter being referred to them, either party may give a notice to the other requiring that the Dispute be referred to mediation.
- 23.3 **Appointment of mediator:** Within 10 Working Days of receipt of the notice referring the Dispute to mediation, the parties must attempt to agree on the identity of the mediator and, if they cannot agree within that timeframe, the mediator will be appointed by the President (or their nominee) of the New Zealand chapter of the Resolution Institute.
- 23.4 **Conduct of mediation:** In consultation with the mediator, the parties must determine a location, timetable and procedure for the mediation or, if the parties cannot agree on

these matters within 7 Working Days of the appointment of the mediator these matters will be determined by the mediator.

- 23.5 **Appointment of representative:** Each party must appoint a representative for the purposes of the mediation who must have authority to reach an agreed solution and effect settlement.
- 23.6 **Conduct during mediation:** In all matters relating to the mediation:
- (a) **Act in good faith:** the parties and their representatives must act in good faith and use their best endeavours to ensure the expeditious completion of the mediation procedure;
 - (b) **Without prejudice:** all proceedings and disclosures will be conducted and made without prejudice to the rights and positions of the parties in any subsequent arbitration or other legal proceedings;
 - (c) **Mediator's decisions binding only on conduct of the mediation:** any decision or recommendation of the mediator will not be binding on the parties in respect of any matters whatsoever except with regard to the conduct of the mediation;
 - (d) **Costs of mediation borne equally:** the costs of the mediation, other than the parties' legal costs, will be borne equally by the parties, who will be jointly and severally liable to the mediator in respect of the mediator's fees.
- 23.7 **Arbitration to resolve disputes:** Either party may refer the Dispute to arbitration if the Dispute:
- (a) is not resolved through mediation within 40 Working Days (or such longer period agreed by the parties) of the appointment of a mediator; or
 - (b) is not resolved by negotiation of the Chief Executives (or their representatives) in accordance with clause 23.1 within 15 Working Days of the matter being referred to them and neither party referred the Dispute to mediation.
- 23.8 **Arbitration:** A Dispute referred to arbitration under clause 23.7 must be resolved by a sole arbitrator under the Arbitration Act 1996. The arbitrator's decision will be final and binding on the parties.
- 23.9 **Choice of arbitrator:** The sole arbitrator must be appointed by the parties. If the parties cannot agree on the identity of the arbitrator within 10 Working Days of the referral in clause 23.7, the arbitrator will be appointed by the President of the New Zealand Law Society.
- 23.10 **No connection to previous mediator or mediation:** If the Dispute has been referred to mediation, the mediator may not be called by either party as a witness, and no reference may be made to any determination issued by the mediator in respect of the matter in Dispute during any subsequent arbitration or legal action on the matter in Dispute.
- 23.11 **Urgent relief:** Despite any other provision of this Agreement, each party may take steps to seek urgent injunctive or equitable relief before an appropriate court.
- 23.12 **Disclosure of arbitrator's decision:** Either party may disclose the arbitrator's decision under clause 23.8 to the Electricity Authority in accordance with the Code.
- 24. LIABILITY**
- 24.1 **Payments of charges:** Nothing in this clause 24 will operate to limit the liability of either party to pay all charges and other sums due under this Agreement, or in accordance with any requirements set under Part 4 of the Commerce Act 1986.

- 24.2 **Direct damage:** Except in respect of liability under clauses 20, 24.9, 25, and 27, each party (and its officers, employees, and agents) will be liable under or in connection with this Agreement (whether in contract, tort (including negligence), or otherwise) to the other party for only direct damage to the physical property of any person ("**Direct Damage**") that results from a breach of this Agreement, negligence, or failure to exercise Good Electricity Industry Practice.
- 24.3 **Consequential loss excluded:** Except in respect of liability under clauses 20, 24.9, 25, and 27, neither party (nor any of their respective officers, employees, or agents) will be liable under or in connection with this Agreement (whether in contract, tort (including negligence), or otherwise) to the other party for:
- (a) any loss of profit, loss of revenue, loss of use, loss of opportunity, loss of contract, or loss of goodwill of any person;
 - (b) any indirect or consequential loss (including, but not limited to, incidental or special damages);
 - (c) any loss resulting from liability of a party to another person (except any liability for Direct Damage that arises under clause 24.2); or
 - (d) any loss resulting from loss or corruption of, or damage to, any electronically-stored or electronically-transmitted data or software.
- 24.4 **No liability in tort, contract etc:** Except as expressly provided in clauses 20, 24, 25, and 27, the Distributor's liability to the Trader and the Trader's liability to the Distributor, whether in tort (including negligence), contract, breach of statutory duty, equity, or otherwise arising from the relationship between them and of any nature whatsoever relating to the subject matter of this Agreement is excluded to the fullest extent permitted by law.
- 24.5 **Distributor not liable:** Except as provided in clause 25, the Distributor will not be liable for:
- (a) any failure to convey electricity to the extent that:
 - (i) such failure arises from any act or omission of any Customer or other person excluding the Distributor and its officers, employees, or agents;
 - (ii) such failure arises from a request by the System Operator or any action taken as a result of a nationally or regionally coordinated response to a shortage of electricity that results in either:
 - (A) a failure to convey or reduction of injection or supply of electricity into the Network; or
 - (B) an interruption in the conveyance of electricity in the Network;
 - (iii) such failure arises from any defect or abnormal conditions in or about any Customer's Premises;
 - (iv) the Distributor was taking any action in accordance with this Agreement including clause 4.4;
 - (v) such failure arises from any act or omission of the System Operator, a Generator, or a Grid Owner, unless and to the extent that the Distributor has obtained a service guarantee from the System Operator or Grid Owner and the System Operator or Grid Owner has paid the Distributor under the relevant service guarantee, in which case the Distributor will be liable to the Trader only to the extent of the Trader's proportionate share of such

- payment having regard to all other traders and all customers affected by the relevant event, as determined by the Distributor (acting reasonably); or
- (vi) such failure arises because the Distributor is prevented from making necessary repairs (for example by police at an accident scene), except to the extent that the failure is caused or contributed to by the Distributor not acting in accordance with this Agreement; or
- (b) any failure to perform any obligation under this Agreement caused by the Trader's failure to comply with this Agreement, except to the extent that the failure is caused or contributed to by the Distributor not acting in accordance with this Agreement; or

Requirements for recorded terms: *If any additional exclusions from liability not already covered by clause 24.5(a)-(b) apply, insert as clause 24.5(c) a recorded term setting out those exclusions. If no additional exclusions apply, it is not necessary to insert a clause 24.5(c). An example is provided in clause 24.5(c). Revise or delete as appropriate and then delete this dashed box.*

- (c) *any momentary fluctuations in the voltage or frequency of electricity conveyed or nonconformity with harmonic voltage and current levels.*

24.6 **Trader not liable:** The Trader will not be liable for:

- (a) any failure to perform any obligation under this Agreement caused by the Distributor's failure to comply with this Agreement; or
- (b) any failure to perform any obligation under this Agreement arising from any defect or abnormal conditions in the Network, except to the extent that the failure is caused or contributed to by the Trader not acting in accordance with this Agreement.

24.7 **Limitation of liability:** Subject to clauses 24.1 and 24.8, but despite any other provision of this Agreement, the maximum total liability of each party under or in connection with this Agreement (whether in contract, tort (including negligence), or otherwise) for any single event or series of connected events will not in any circumstances exceed the lesser of \$10,000 for each ICP on the Network at which the Trader traded electricity on the day of the event, or \$2,000,000.

24.8 **Exclusion:** Clause 24.7:

- (a) does not limit a party's liability under clauses 20, 24.9, 25, or 27;
- (b) is subject to any contrary requirements of the Dispute Resolution Scheme;
- (c) does not apply to loss incurred by the Distributor if:
- (i) the loss was caused by a Customer failing to comply with the Distributor's Network Connection Standards;
- (ii) the Trader is required by this Agreement to include in each of its Customer Agreements a provision requiring the Customer to comply with those Network Connection Standards; and
- (iii) the Customer Agreement between the Trader and the Customer did not include such a provision.

24.9 **Consumer Guarantees Act:** The following provisions apply:

- (a) subject to clause 29.1, the Trader must, to the fullest extent permitted by law and including if the Customer is acquiring or holds itself out as acquiring electricity for the purpose of a business, exclude from each of its Customer Agreements

(which includes a contract between the Trader and a purchaser of electricity that is not an end user) all warranties, guarantees, or obligations:

- (i) imposed on the Distributor by the Consumer Guarantees Act 1993 or any other law concerning the services to be provided by the Distributor under this Agreement ("Distributor Warranties"); and
 - (ii) imposed on the Trader by the Consumer Guarantees Act 1993 or any other law concerning the supply of electricity by the Trader under the Customer Agreement ("Trader Warranties");
- (b) if the Customer on-supplies electricity to an end-user the Trader must, as a condition of any Customer Agreement, require the Customer to include provisions in all agreements between the Customer and an end-user, excluding all Distributor Warranties and Trader Warranties to the fullest extent permitted by law, including if the end-user is acquiring, or holds itself as acquiring, electricity for the purposes of a business;
- (c) to avoid doubt, nothing in this clause 24.9 affects the rights of any Customer under the Consumer Guarantees Act 1993 that cannot be excluded by law, nor does it preclude the Trader from offering in its Customer Agreements its own warranties, guarantees, or obligations pertaining to distribution services; and
- (d) for the purposes of paragraph (a), the obligation to exclude warranties, guarantees, or obligations if the Customer is acquiring or holds itself out as acquiring electricity for the purpose of a business only applies if such exclusion is permissible under section 43 of the Consumer Guarantees Act 1993.

24.10 Distributor liabilities and Customer Agreements: The Trader must, subject to clause 29.1, include in each of its Customer Agreements clear and unambiguous clauses to the effect that:

- (a) the Customer must indemnify the Distributor against any direct loss or damage caused or contributed to by the fraud of, dishonesty of, or wilful breach of the Customer Agreement by the Customer or any of its officers, employees, agents, or invitees arising out of, or in connection with, the Distribution Services provided under this Agreement; and
- (b) to the extent permitted by law, the Distributor will have no liability to the Customer in contract, tort (including negligence), or otherwise in respect of the supply of electricity to the Customer under the Customer Agreement.

24.11 Benefits to extend: Each party agrees that its obligations under this clause 24 and clauses 25 to 28 (and clause 29.3 in respect of the Trader) constitute promises conferring benefits on each party's officers, employees, and agents that are intended to create, in respect of the benefit, an obligation enforceable by those officers, employees, and agents and accordingly, the provisions of Part 2 of the Contract and Commercial Law Act 2017 apply to its promises under this clause 24. The clauses referred to in this clause may be varied by agreement between the parties without the consent of the beneficiaries described in this clause.

25. INDEMNITY

25.1 Distributor indemnity: Despite anything else in this Agreement, the Trader is entitled to be indemnified by the Distributor as set out in section 46A of the Consumer Guarantees Act 1993.

26. CLAIMS UNDER THE DISTRIBUTOR'S INDEMNITY

26.1 **Claim against Trader:** If a Customer makes a claim against the Trader in relation to which the Trader seeks (at the time of the claim or later) to be indemnified by the Distributor under section 46A of the Consumer Guarantees Act 1993 (a "Claim"), the Trader must:

- (a) give written notice of the Claim to the Distributor as soon as practicable after the Trader has become aware of the Claim and any facts or circumstances indicating that the underlying failure may be related to an event, circumstance, or condition associated with the Network, specifying the nature of the Claim in reasonable detail; and
- (b) make available to the Distributor all information that the Trader holds in relation to the Claim that is reasonably required by the Distributor.

26.2 **Payment arrangements:** If the Distributor is required to indemnify the Trader under section 46A of the Consumer Guarantees Act 1993, the Distributor must promptly pay the Trader the amounts due under that Act.

26.3 **Dispute resolution:** Any dispute between the Distributor and the Trader relating to the existence or allocation of liability under section 46A of the Consumer Guarantees Act 1993 must be dealt with by each party in accordance with the Dispute Resolution Scheme or, if the dispute is not accepted by the scheme, the parties must deal with the dispute in accordance with clause 23.

27. FURTHER INDEMNITY

27.1 **Distributor will be indemnified:** Subject to clause 28, the Trader indemnifies and holds harmless the Distributor and will keep the Distributor indemnified and held harmless from and against any direct loss or damage (including legal costs on a solicitor/own client basis) suffered, or incurred by the Distributor arising out of or in connection with:

- (a) any claim by any person with whom the Trader has a contractual relationship in relation to the provision of services or the conveyance of electricity on the Network to the extent that the claim arises out of or could not have been made but for:
 - (i) any breach by the Trader of any of its obligations under this Agreement;
 - (ii) the disconnection by the Trader, or disconnection requested by the Trader, of any Customer's Premises in accordance with this Agreement, unless the disconnection is necessary to comply with Good Electricity Industry Practice or if the disconnection is due to this Agreement being terminated for the Distributor's breach or Insolvency Event;
 - (iii) the termination of this Agreement by the Trader, except when the termination is the result of a breach by the Distributor or the Distributor suffering an Insolvency Event;
 - (iv) any failure by the Trader to perform any obligation under any agreement between the Trader and any Generator or Customer or other third party;
 - (v) any failure by the Trader to comply with its obligations required by law or regulation; or

- (vi) any action undertaken by the Distributor under or in connection with this Agreement at the request of the Trader; and
 - (b) any recovery activity of the Distributor in respect of any unpaid charges or interest payable under this Agreement.
- 27.2 **Trader will be indemnified:** Subject to clause 28, the Distributor indemnifies and holds harmless the Trader and will keep the Trader indemnified and held harmless from and against any direct loss or damage (including legal costs on a solicitor/own client basis), suffered, or incurred by the Trader arising out of or in connection with:
- (a) any claim by any person with whom the Distributor or Trader has a contractual relationship in relation to the provision of services or conveyance of electricity to the extent that claim arises out of or could not have been made but for:
 - (i) any breach by the Distributor of its obligations under this Agreement;
 - (ii) the disconnection by the Distributor of any Customer's Premises in accordance with this Agreement, unless the disconnection is necessary to comply with Good Electricity Industry Practice or if the disconnection is due to this Agreement being terminated for the Trader's breach or Insolvency Event;
 - (iii) the termination of this Agreement by the Distributor, except when the termination is the result of a breach by the Trader or the Trader suffering an Insolvency Event;
 - (iv) any failure by the Distributor to perform any obligation under any agreement between the Distributor and the System Operator or any other third party;
 - (v) any failure by the Distributor to comply with its obligations required by law or regulation; or
 - (vi) any action undertaken by the Trader under or in connection with this Agreement at the request of the Distributor; and
 - (b) any recovery activity of the Trader in respect of any unpaid charges or interest payable under this Agreement.
- 27.3 **Other rights and remedies not affected:** The indemnities in this clause 27 are in addition to, and without prejudice to, the rights and remedies of each party under this Agreement or under statute or in law, equity, or otherwise.

28. CONDUCT OF CLAIMS

- 28.1 **Third Party Claim:** This clause applies if a party with a right of indemnity under clause 27 ("**Indemnified Party**") seeks or may seek to be indemnified by the other party ("**Indemnifying Party**") under clause 27 in respect of a claim by any person of the kind described in clause 27.1(a) or 27.2(a) ("**Third Party Claim**").
- 28.2 **Indemnified Party to give Notice of Third Party Claim:** The Indemnified Party must give notice of the Third Party Claim (including reasonable details) to the Indemnifying Party and ensure that the Indemnified Party does not make any payment or admission of liability in respect of the Third Party Claim.
- 28.3 **Indemnifying Party may act in relation to Third Party Claim:** The Indemnifying Party may, at its election, in the name of the Indemnified Party, but only after consultation with the Indemnified Party and so that the reputation of the Indemnified Party is not unfairly harmed, conduct all negotiations and defend any proceedings

relating to the Third Party Claim. For this purpose, the Indemnified Party must make available to the Indemnifying Party all such information, books and records, and co-operate (including making available employees as witnesses) as the Indemnifying Party may reasonably require for the purpose.

- 28.4 **Indemnified Party to keep Indemnifying Party informed:** If and for so long as the Indemnifying Party does not assume the defence of the Third Party Claim, the Indemnified Party must:
- (a) keep the Indemnifying Party fully informed of the Indemnified Party's progress in defending the Indemnified Claim and of any related proceedings; and
 - (b) at the Indemnifying Party's request, consult with, and take account of the reasonable views of, the Indemnifying Party so far as reasonably practicable in the relevant Indemnified Party's defence of the Third Party Claim and any related proceedings.
- 28.5 **Third Party Claim not to be settled without consent:** The Indemnified Party must not, without the prior written consent of the Indemnifying Party, settle the Third Party Claim.
- 28.6 **Indemnifying Party to be reimbursed:** If the Indemnified Party recovers from any third party any amount to which a payment made by the Indemnifying Party to the Indemnified Party under this Agreement relates, the Indemnified Party must procure that the amount so recovered by the Indemnified Party (net of the cost of recovery, but not exceeding the amount paid by the Indemnifying Party) will be reimbursed without delay to the Indemnifying Party.

29. CUSTOMER AGREEMENTS

- 29.1 **Trader to include provisions in Customer Agreements:** The following clauses apply in respect of the Trader's Customer Agreements:
- (a) in respect of each Customer Agreement that has been entered into prior to the Commencement Date:
 - (i) at the next review date, or, if the Trader is able to unilaterally vary the Customer Agreement, within 12 months after the Commencement Date (whichever is earlier), the Trader must issue a unilateral variation to the Customer Agreement to include provisions that have substantially the same effect as the provisions required to be included in the Customer Agreement by this Agreement, and those provisions must be expressed to be for the benefit of the Distributor and enforceable by the Distributor in accordance with section 12 of the Contract and Commercial Law Act 2017; or
 - (ii) if the Trader is unable to unilaterally vary 1 or more Customer Agreements as set out in subparagraph (i), the Trader must:
 - (A) use all reasonable endeavours to obtain at the next review of each Customer Agreement, or within 12 months, whichever is earlier, the agreement of the Customer to enter into a variation of the Customer Agreement to include the provisions required to be included in the Customer Agreement by this Agreement, and those provisions must be expressed to be for the benefit of the Distributor and enforceable by the Distributor under section 12 of the Contract and Commercial Law Act 2017; and

- (B) promptly provide notice to the Distributor if it is unable to obtain the agreement of the Customer required in subparagraph (A); or
- (b) in respect of each Customer Agreement that has been entered into after the Commencement Date, include the provisions required to be included in the Customer Agreement by this Agreement, and those provisions must be expressed to be for the benefit of the Distributor and enforceable by the Distributor in accordance with section 12 of the Contract and Commercial Law Act 2017.
- 29.2 **Changes to Customer Agreements during term:** If this Agreement is changed in accordance with clause 22.1(a) or clause 22.1(c), and the change requires the Trader to amend its Customer Agreements, the Trader must take such steps as are necessary to amend those agreements.
- 29.3 **Trader to indemnify Distributor:** Subject to clause 24, the Trader indemnifies the Distributor against any direct loss or damage incurred by the Distributor as a result of the Trader's failure to meet its obligations in accordance with clause 29.1.

30. NOTICES

- 30.1 **Delivery of Notices:** Any notice given under this Agreement must be in writing and will be deemed to be validly given if personally delivered, posted, or sent by facsimile transmission or email to the address for notice set out on the execution page of this agreement or to such other address as that party may notify from time to time.
- 30.2 **Receipt of Notices:** Any notice given under this Agreement will be deemed to have been received:
- (a) in the case of personal delivery, when delivered;
 - (b) in the case of facsimile transmission, when sent, provided that the sender has a facsimile confirmation receipt recording successful transmission;
 - (c) in the case of posting, 3 Working Days following the date of posting; and
 - (d) in the case of email, when actually received in readable form by the recipient, provided that a delivery failure notice has not been received by the sender, in which case the notice will be deemed not to have been sent.
- 30.3 **Deemed receipt after 5pm or day that is not Working Day:** Any notice given in accordance with clause 30.2 that is personally delivered or sent by facsimile or email after 5pm on a Working Day or on any day that is not a Working Day will be deemed to have been received on the next Working Day.

31. ELECTRICITY INFORMATION EXCHANGE PROTOCOLS

- 31.1 **Protocols for exchanging information:** The Distributor and the Trader must, when exchanging information to which an EIEP listed in Schedule 3 relates, comply with that EIEP.
- 31.2 **Customer information:** The Trader will on reasonable written request from the Distributor, and within a reasonable timeframe, provide the Distributor with such Customer information as is reasonably available to the Trader and necessary to enable the Distributor to fulfil its obligations in accordance with this Agreement. The information will be treated by the Distributor as Confidential Information and the Distributor expressly acknowledges and agrees that it is not authorised to, and will not, use such information in any way or form other than as permitted by this clause 31.2.

- 31.3 **Auditing information provided:** To enable either party to this Agreement (the “**Verifier**”) to verify the accuracy of information provided to it by the other party to this Agreement (the “**Provider**”), the Provider will allow the Verifier and its agents reasonable access to the Provider’s books and records (the “**Records**”) to the extent that those Records relate to the obligations of the Provider under this Agreement. Access to such Records will be given at all reasonable times providing the Verifier has given the Provider not less than 10 Working Days' prior notice. If the Trader is the Provider and any relevant information is held by a third party Metering Equipment owner or operator, the Trader will procure access to the third party Metering Equipment owner or operator’s books and records for the benefit of the Distributor (provided that doing so does not impose any additional costs on the Trader).
- 31.4 **Limitations on the Verifier:** In relation to its review of the Records under clause 31.3, the Verifier will not:
- (a) use the information obtained for any purpose other than verifying the accuracy of information provided by the Provider under this Agreement; and
 - (b) engage as its agent any person that is in competition with the Provider, any person who is related to a person in competition with the Provider, or any employee, director, or agent of such persons. For the purposes of this clause 31.4(b), a person is related to another person if it is a related company (as that term is defined in section 2(3) of the Companies Act 1993) of that other person.
- 31.5 **Independent Auditor:** If:
- (a) the Provider is the Distributor and, acting reasonably, gives notice that the Records contain information about other industry participants that cannot reasonably be severed from the information relating to the Trader or that the information is commercially sensitive; or
 - (b) the provider is the Trader and, acting reasonably, gives notice that the Records contain information about other industry participants that cannot reasonably be severed from information relating to the Distributor or that the information is commercially sensitive,
- then the Distributor or the Trader, as appropriate, will permit an independent auditor (the “**Auditor**”) appointed by the other party to review the Records and the other party will not itself directly review any of the Records. The Distributor or the Trader, as appropriate, will not unreasonably object to the Auditor appointed by the other party. In the event that the Distributor or the Trader, as appropriate, reasonably objects to the identity of the Auditor, the parties will request the President of the New Zealand Law Society (or a nominee) to appoint a person to act as the Auditor. The party that is permitted by this clause 31.5 to appoint an Auditor will pay the Auditor’s costs, unless the Auditor discovers a material inaccuracy in the Records in which case the other party will pay the Auditor’s costs. The terms of appointment of the Auditor will require the Auditor to keep the Records confidential.
- 31.6 **Provider will co-operate:** The Provider will co-operate with the Verifier or the Auditor (as the case may be) in its review of the Provider’s Records under clause 31.3 or 31.5 and will ensure that the Records are readily accessible and readable.

32. MISCELLANEOUS

- 32.1 **No waiver:** Unless a party has signed an express written waiver of a right under this Agreement, no delay or failure to exercise a right under this Agreement prevents the exercise of that or any other right on that or any other occasion. A written waiver applies only to the right and to the occasion specified by it.
- 32.2 **Entire agreement:** This Agreement records the entire agreement, and prevails over any earlier agreement concerning its subject.
- 32.3 **No assignment:** Neither party may assign any benefit or burden under or in relation to this Agreement without the prior written consent of the other party, such consent not to be unreasonably delayed or withheld. For the purposes of this clause 32.3, unless a party is listed on the New Zealand Stock Exchange, a change in control of a party will be deemed to be an assignment.
- 32.4 **Severance:** Any unlawful provision in this Agreement will be severed, and the remaining provisions enforceable, but only if the severance does not materially affect the purpose of, or frustrate, this agreement.

33. INTERPRETATION

- 33.1 **Interpretation:** Unless the context otherwise requires or specifically otherwise stated:
- (a) headings are to be ignored;
 - (b) "including" and similar words do not imply any limitation;
 - (c) references to any form of law is to New Zealand law, including as amended or re-enacted;
 - (d) if a party comprises more than 1 person, each of those person's liabilities are joint and several;
 - (e) references to a party or a person includes any form of entity and their respective successors, assigns and representatives;
 - (f) every right, power, and remedy of a party remains unrestricted and may be exercised without prejudice to each other at any time;
 - (g) all amounts payable under this Agreement are in New Zealand dollars and exclude GST and every other tax and duty, but if GST is payable on any amount it will be added to that amount and will be payable at the time the amount itself is payable, and unless otherwise stated;
 - (h) New Zealand time and dates apply;
 - (i) any word or expression cognate with a definition in this Agreement has a meaning corresponding or construed to the definition;
 - (j) references to sections, clauses, Schedules, annexes, or other identifiers are to those in this Agreement unless otherwise identified; and
 - (k) references to a document or agreement includes it as varied or replaced.
- 33.2 **Definitions:** In this Agreement, unless the context otherwise requires:
- "Act" means the Electricity Industry Act 2010;
- "Additional Security" has the meaning given in clause 10.6;
- "Agreement" means this distribution agreement, including each Schedule and any other attachment or document incorporated by reference;
- "Bank Bill Yield Rate" means:
- (a) the daily bank bill yield rate (rounded upwards to 2 decimal places) published on the wholesale interest rates page of the website of the Reserve Bank of New

Zealand (or its successor or equivalent page) on a day as being the daily bank bill yield for bank bills having a tenor of 90 days; or

- (b) for any date for which such a rate is not available, the bank bill yield rate is deemed to be the bank bill yield rate determined in accordance with paragraph (a) on the last day that such a rate was available;

"**Cash Deposit**" has the meaning given in clause 10.2;

"**Chief Executive**" means the chief executive officer of the relevant party to this Agreement;

"**Code**" means the Electricity Industry Participation Code 2010 made under the Act;

"**Commencement Date**" means the date specified in clause 1.1;

"**Confidential Information**" means all data and other information of a confidential nature provided by 1 party to the other under the terms of this Agreement or otherwise that is identified by the party providing the information as being confidential, or should reasonably be expected by the other party to be confidential, but excludes:

- (a) information known to the recipient prior to the date it was provided to it by the first party and not obtained directly or indirectly from the first party;
- (b) information obtained bona fide from another person who is in lawful possession of the information and did not acquire the information directly or indirectly from the first party under an obligation of confidence; and
- (c) the existence and terms of this Agreement;

"**Connection Contract**" means a contract under which Distributed Generation is connected to the Network entered into by the Distributor and a Distributed Generator in accordance with Part 6 of the Code, and, for the purposes of this Agreement, the Distributor and a Distributed Generator are deemed to have entered into a Connection Contract if the regulated terms in Part 6 of the Code apply;

"**Controlled Load Option**" has the meaning given in clause 5.1(a);

"**Conveyance Only**" means a situation in which the Trader contracts with the Customer for the supply of electricity only in relation to an ICP and the Distributor does not provide Distribution Services to the Trader in respect of that ICP;

"**Credit Note**" has the meaning given in the GST Act;

"**Customer**" means a person who purchases electricity from the Trader that is delivered via the Network;

"**Customer Agreement**" means an agreement between the Trader and the Customer that includes the supply of electricity and Distribution Services;

"**Customer Service Lines**" means the lines used or intended to be used for the conveyance of electricity between the Customer's Point of Connection and the Customer's Premises;

"**Customer's Installation**" means an Electrical Installation and includes Distributed Generation, if Distributed Generation is connected to a Customer's Installation;

"**Customer's Premises**" means the land and buildings owned or occupied by a Customer, and any land over which the Customer has an easement or right to pass electricity, including:

- (a) the land within the boundary within which the electricity is consumed;
- (b) the whole of the property, if the property is occupied wholly or partially by tenants or licensees of the owner or occupier; and

(c) the whole of the property that has been subdivided under the Unit Titles Act 1972 or the Unit Titles Act 2010;

"**Debit Note**" has the meaning given in the GST Act;

"**Decommission**" means the decommissioning of an ICP in accordance with Part 11 of the Code so that the ICP is permanently disconnected from the Network, and the Registry status has been altered to "decommissioned" (but excludes a Vacant Site Disconnection);

"**De-energise**" means the operation of any isolator, circuit breaker, or switch or the removal of any fuse or link so that no electricity can flow through a Point of Connection on the Network;

Requirements for recorded terms: Insert definitions for "Default Interest" and "Default Interest Rate" as recorded terms in clause 33.2. Examples are provided in the box below. Revise as appropriate and then delete this dashed box.

"Default Interest" means interest on the amount payable at the Default Interest Rate from the due date for payment until the date of payment of that amount to the relevant party accruing on a daily basis and compounded monthly;

"Default Interest Rate" means the Interest Rate plus 5%;

"**Direct Customer Agreement**" means an agreement between the Distributor and a Customer for the provision of Distribution Services;

"**Direct Damage**" has the meaning given in clause 24.2;

"**Dispute**" has the meaning given in clause 23.1;

"**Dispute Resolution Scheme**" means Utilities Disputes or such other dispute resolution scheme approved or provided for in accordance with section 95 of the Act;

"**Distributed Generation**" means generating plant equipment collectively used for generating electricity that is connected, or proposed to be connected, to the Network or a Customer's Installation, but does not include:

- (a) generating plant connected to the Network and operated by the Distributor for the purpose of maintaining or restoring the provision of electricity to part or all of the Network:
- (i) as a result of a Planned Service Interruption; or
 - (ii) as a result of an Unplanned Service Interruption; or
 - (iii) during a period when the Network capacity would otherwise be exceeded on part or all of the Network; or

- (b) generating plant that is only momentarily synchronised with the Network for the purpose of switching operations to start or stop the generating plant;

"**Distributed Generator**" means a person who owns or operates Distributed Generation;

"**Distribution Services**" means the service of distribution, as defined in section 5 of the Act;

"**Distributor**" means the party identified as such in this Agreement;

"**Distributor's Equipment**" means the Fittings and Metering Equipment owned by the Distributor, the Distributor's agent, or any other third party with whom the Distributor has contracted with for the use by the Distributor of the party's Fittings or Metering Equipment that are from time to time installed in, over, or on Customer's Premises;

"**EIEP**" means an electricity information exchange protocol approved by the Electricity Authority and published in accordance with the Code;

"Electrical Installation" means:

- (a) all Fittings that form part of a system for conveying electricity at any point from the Customer's Point of Connection to any point from which electricity conveyed through that system may be consumed; and
- (b) includes any Fittings that are used, or designed or intended for use, by any person, in or in connection with the generation of electricity for that person's use and not for supply to any other person; but
- (c) does not include any appliance that uses, or is designed or intended to use, electricity, whether or not it also uses, or is designed or intended to use, any other form of energy;

"Electricity Authority" has the meaning given in section 5 of the Act;

"Electricity Only Supply Agreement" means an agreement between the Trader and a Customer for the supply of electricity only;

"Energise" means the operation of an isolator, circuit breaker, or switch, or the placing of a fuse or link, so that electricity can flow through a Point of Connection on the Network;

"Entrant" has the meaning given in clause 5.3;

"Event of Default" has the meaning given in clause 18.3(a);

"Fitting" means everything used, designed, or intended for use, in or in connection with the generation, conversion, transformation, conveyance, or use of electricity;

"Force Majeure Event" has the meaning given in clause 21.1;

"Generator" means any person that owns a machine that generates electricity that is connected to a network, including a Distributed Generator;

"Good Electricity Industry Practice" means:

- (a) in the case of the Distributor, the exercise of that degree of skill, diligence, prudence, foresight and economic management that would reasonably be expected from a skilled and experienced electricity network owner engaged in New Zealand in the distribution of electricity under conditions comparable to those applicable to the Network consistent with applicable law, safety and environmental protection. The determination of comparable conditions is to take into account factors such as the relative size, duty, age and technological status of the Network and the applicable law; and
- (b) in the case of the Trader, the exercise of that degree of skill, diligence, prudence, foresight and economic management that would reasonably be expected from a skilled and experienced electricity trader engaged in New Zealand in the same type of undertaking under comparable conditions consistent with applicable law, safety and environmental protection;

"Grid" means the system of transmission lines, substations and other works, including the HVDC link used to connect grid injection points and GXPs to convey electricity throughout the North Island and the South Island of New Zealand;

"Grid Owner" means a person who owns or operates any part of the Grid;

"GST" means goods and services tax payable under the GST Act;

"GST Act" means the Goods and Services Tax Act 1985;

"GXP" means any Point of Connection on the Grid:

- (a) at which electricity predominantly flows out of the Grid; or
- (b) determined as being such in accordance with the Code;

"**ICP**" means an installation control point being 1 of the following:

- (a) a Point of Connection at which a Customer's Installation is connected to the Network;
- (b) a Point of Connection between the Network and an embedded network;
- (c) a Point of Connection between the Network and shared Unmetered Load;

"**Incumbent**" has the meaning given in clause 5.3;

"**Industry**" means those parties involved in the generation, transmission, distribution, and retailing of electricity in New Zealand;

"**Insolvency Event**" means a party:

- (a) has had a receiver, administrator, or statutory manager appointed to or in respect of the whole or any substantial part of its undertaking, property, or assets;
- (b) is deemed or presumed (in accordance with law) to be unable to pay its debts as they fall due, becomes or is deemed (in accordance with law) to be insolvent, or is in fact unable to pay its debts as they fall due, or proposes or makes a compromise, or an arrangement or composition with or for the benefit of its creditors or fails to comply with a statutory demand under section 289 of the Companies Act 1993; or
- (c) is removed from the register of companies (otherwise than as a consequence of an amalgamation) or an effective resolution is passed for its liquidation;

Requirements for recorded terms: *Insert a definition of "Interest Rate" as a recorded term in clause 33.2. An example is provided in the box below. Revise as appropriate and then delete this dashed box.*

"Interest Rate" means, on any given day, the rate (expressed as a percentage per annum and rounded up to nearest fourth decimal place) displayed on the Reuter's screen page BKBM (or its successor page) at or about 10.45 a.m. on that day, as the bid rate for 3 month bank accepted bills of exchange or, if no such rate is displayed or that page is not available, the average (expressed as a percentage per annum and rounded up to the nearest fourth decimal place) of the bid rates for 3 month bank accepted bills of exchange quoted at or about 10.45 a.m. on that day by each of the entities listed on that Reuter's screen page when the rate was last displayed or, as the case may be, that page was last available;

"**Interposed**" means in relation to a Customer, that the Distributor provides Distribution Services to the Trader and the Trader contracts with the Customer for the supply of those services;

"**Load Control Equipment**" means the equipment (which may include, but is not limited to, ripple receivers and relays) that is from time to time installed in, over or on Customer's Premises for the purpose of receiving signals sent by Load Signalling Equipment and switching on and off, or otherwise controlling, controllable load;

"**Load Control System**" means a control and communications system for controlling parts of a Customer's load and consisting of Load Signalling Equipment and Load Control Equipment;

"**Load Signalling Equipment**" means the equipment (which may include, but is not limited to, ripple injection plant) for the purpose of sending control signals to Load Control Equipment;

"**Load Shedding**" means the act of reducing or interrupting the delivery of electricity to 1 or more ICPs;

"Losses" means, for a particular period, the difference between the sum of all electricity injected into a network and the sum of all electricity measured or estimated as having exited that network;

"Loss Category" means the code in the Registry, and in the schedule of Loss Category codes and Loss Factors made available by the Distributor, which enables traders to identify the Loss Factor(s) applicable to an ICP on the Network at any point in time;

"Loss Factor" means the scaling factor determined in accordance with clause 6 and applied by the reconciliation manager to volumes of electricity measured or estimated in respect of ICPs on the Network, in order to reflect the impact of the ICP on Losses within the Network;

"Metering Equipment" means any apparatus for the purpose of measuring the quantity of electricity transported through an ICP along with associated communication facilities to enable the transfer of metering information;

"Network" means the Distributor's lines, substations and associated equipment used to convey electricity between:

- (a) 2 NSPs; or
- (b) an NSP and an ICP;

"Network Connection Standards" means the Distributor's written technical and safety standards for connection of an Electrical Installation to the Network that are issued by the Distributor and updated from time to time, and include:

- (a) a list of all referenced regulations and industry standards relevant to the provision of the Distribution Services; and
- (b) all externally referenced publications, such as website links in those regulations and standards;

"Network Supply Point" or "NSP" means any Point of Connection between:

- (a) the Network and the Grid; or
- (b) the Network and another distribution network; or
- (c) the Network and an embedded network; or
- (d) the Network and Distributed Generation;

"Other Load Control Option" has the meaning given in clause 5.1(b);

"Planned Service Interruption" means a Service Interruption that has been scheduled to occur in accordance with Schedule 5;

"Point of Connection" means the point at which electricity may flow into or out of the Network;

"Price" means a fixed or variable rate within a Price Category that determines the Distribution Services charges that apply to an ICP;

"Price Category" means the price category and associated eligibility criteria referred to in Schedule 7 that determine the Price(s) that apply to an ICP;

"Price Options" has the meaning given in clause 8.5;

"Pricing Structure" means the Distributor's policies and processes relating to setting Prices for Distribution Services referred to in Schedule 7;

"Publish" means to disclose information by making the information freely and publicly available on the Distributor's website and notifying the Trader that the information has been disclosed on the website;

"Re-energise" means to Energise an ICP after it has been De-energised;

"Registry" means the central database of ICP information maintained in accordance with the Code to assist switching and reconciliation;

"Revision Invoice" has the meaning given in clause 9.3;

"Rulings Panel" has the meaning given to it in section 5 of the Act;

"Serious Financial Breach" means:

- (a) a failure by the Trader to pay an amount due and owing that exceeds the greater of \$100,000 or 20% of the actual charges payable by the Trader for the previous month, unless the amount is genuinely disputed by the Trader in accordance with clause 9.7; or
- (b) a failure by the Trader to pay 100% of the actual charges payable by the Trader for the previous two months, unless the amount is genuinely disputed by the Trader in accordance with clause 9.7; or
- (c) a material breach of clause 10 by the Trader;

"Service Guarantee Payment" means any payment or other benefit that 1 party provides to the other party if it fails to meet a Service Standard for which a guarantee payment is required to be paid if that Service Standard is not met;

"Service Interruption" means the cessation of electricity supply to an ICP for a period of 1 minute or longer, other than by reason of De-energisation of that ICP:

- (a) for breach of the Customer Agreement by the Customer; or
- (b) as a result of a request from the Trader or the relevant Customer for a Temporary Disconnection; or
- (c) as a result of a request from the Trader for a Vacant Site Disconnection; or
- (d) for the purpose of De-energising a Customer Installation that does not comply with the Network Connection Standards; or
- (e) to Decommission the ICP;

"Service Level" means the magnitude of a Service Measure;

"Service Measure" means the characteristics or features of a Service Standard as set out in Schedule 1;

"Service Standards" means the set of Service Measures, Service Levels, conditions and Service Guarantee Payments as set out in Schedule 1;

"Switch Event Date" means the date recorded in the Registry as being the date on which a trader assumes responsibility for an ICP;

"System Emergency Event" means a grid emergency in accordance with the definition of that term in Part 1 of the Code and, in respect of the Network, any emergency situation in which:

- (a) public safety is at risk;
- (b) there is a risk of significant damage to any part of the Network;
- (c) the Distributor is unable to maintain Network voltage levels within statutory requirements; or
- (d) an Unplanned Service Interruption affecting part or all of the Network is imminent or has occurred;

"System Operator" has the meaning given to it in section 5 of the Act;

"System Operator Services" means co-ordination services for the control, dispatch and security functions necessary to operate the transmission system;

"System Security" means the security and quality objectives set out in Part 8 of the Code;

"Tax Invoice" means a valid tax invoice as specified by section 24 of the GST Act;

"Temporary Disconnection" means an ICP is De-energised but there is no change to the status of the ICP in the Registry;

"Trader" means the party identified as such in this Agreement;

"Trader's Equipment" means the Fittings and/or Metering Equipment owned by the Trader, the Trader's agent or any other third party with whom the Trader has contracted with for the use by the Trader of such third party's Fittings or Metering Equipment, which are from time to time installed in, over, or on Customer's Premises;

"Transmission Interruption" means a failure of a service provided by a Grid Owner to meet the service standards agreed between the Distributor and that Grid Owner;

"Trust Account Rules" means the rules relating to the establishment and operation of a trust account established and operated by the Distributor in accordance with clause 10.26;

"Unmetered Load" means electricity consumed on the Network that is not directly recorded using Metering Equipment, but is calculated or estimated in accordance with the Code;

"Unplanned Service Interruption" means any Service Interruption where events or circumstances prevent the timely communication of prior warning or notice to the Trader or any affected Customer;

Requirements for recorded terms: Insert a definition for "Use of Money Adjustment" as a recorded term in clause 33.2. An example is provided in the box below. Revise as appropriate and then delete this dashed box.

"Use of Money Adjustment" means an amount payable at the Interest Rate plus 2% from the date of payment to the date of repayment (in the case of a Credit Note or other repayment) or from the due date of the original invoice to the date of payment (in the case of a Debit Note or other payment) accruing on a daily basis and compounded at the end of every month;

"Vacant Site Disconnection" means the De-energisation of an ICP that occurs when the property at which the ICP is located has become vacant, and the Trader has changed the status of the ICP in the Registry to "Inactive";

"Warranted" means pre-qualified to the Distributor's reasonable standards and authorised by the Distributor to carry out the particular work on or in relation to the Network;

"Warranted Person" means a person who is Warranted or who is employed by a person who is Warranted; and

"Working Day" means every day except Saturdays, Sundays, and days that are statutory holidays in the city specified for each party's address for notices identified in the Parties section of this Agreement.

PART V – SCHEDULES

SCHEDULE 1 – SERVICE STANDARDS

Requirements for recorded terms: *If the Distributor must meet any Service Standards when providing Distribution Services, insert as recorded terms in Schedule 1:*

- (a) *a table or tables setting out:*
 - (i) *the Service Standards that the Distributor must meet;*
 - (ii) *any Service Measure relevant to each of those Service Standards;*
 - (iii) *any Service Levels that apply to each Service Measure; and*
 - (iv) *any conditions that apply to any Service Measure; and*
 - (v) *if the Distributor must make a Service Guarantee Payment in the event that the Distributor fails to meet any of those Service Standards, the value of the Service Guarantee Payment or how the Service Guarantee Payment must be calculated; and*
- (b) *a clause or clauses that set out the consequences, if any, for breaching the Service Standards or a Service Level, and any associated procedural requirements.*

If the Distributor must meet Service Standards but there are no Service Measures, Service Levels, conditions, and/or Service Guarantee Payments relevant to 1 or more of those Service Standards, insert in the table(s) the words "not applicable" or leave the relevant part of the table blank as appropriate.

If the Distributor is not required to meet any Service Standards, insert the words "not applicable" in Schedule 1.

Examples of the types of Service Standards that could be recorded in this Schedule include:

- (a) *for each Price Category and Price Option, the time periods in which electricity supply is normally available to Customers;*
- (b) *target levels of power quality, such as measures related to:*
 - (i) *the voltage and frequency of the electricity supply; and*
 - (ii) *the Distributor's process and target timeframes for investigating Customer complaints related to power quality; and*
 - (iii) *the expected frequency of occurrence of Planned Service Interruptions and Unplanned Service Interruptions, possibly categorised by Customer category (such as residential, non-residential etc) and Network locality (such as urban, rural, remote rural, etc);*
- (c) *timeframes for restoring electricity supply following Unplanned Service Interruptions, possibly categorised by Customer category and Network locality; and*
- (d) *requirements for notifications to the Trader and Customers about Planned Service Interruptions.*

An example is shown in clauses SI.1 to SI.5 and Table 1 below. Revise as appropriate and then delete this dashed box.

SI.1 If the Trader becomes aware of or suspects a breach of the Service Standards by the Distributor, the Trader must give the Distributor notice of the reasons why it suspects that there has been a breach.

SI.2 If the Distributor breaches a Service Level, it must notify the Trader as soon as

reasonably practicable and no later than 10 Working Days after becoming aware of the breach. The notification must include:

- (a) the ICP identifier(s) or the Network locality affected by the breach; and*
- (b) the reason for the breach.*

S1.3 If the Distributor breaches a Service Level that is subject to a Service Guarantee Payment, it must notify the Trader as soon as reasonably practicable and no later than 10 Working Days after becoming aware of the breach. The notification must include:

- (a) the ICP identifier of each ICP affected and the Service Guarantee Payment owed by ICP and in total (if applicable);*
- (b) the reason for the breach; and*
- (c) a Credit Note or order number (if the Trader requires a Tax Invoice from the Distributor for the amount payable in respect of the breach, the Distributor must send the Tax Invoice in the next payment cycle).*

S1.4 If the Distributor makes a Service Guarantee Payment in respect of an ICP, the Trader must pass that payment on to the relevant Customer or Customers but may deduct an amount that reflects its reasonable cost of administering the payment.

S1.5 The parties acknowledge that the Service Guarantee Payments are set at a level to provide reasonable compensation to affected Customers in respect of the Distributor's failure to meet the relevant Service Level, and are not a penalty.

Table 1 – Service Standards

SERVICE MEASURE	SERVICE LEVEL	CONDITIONS
1. UNCONTROLLED ELECTRICITY SUPPLY CATEGORY		
1.1 24 hour Continuous Supply: Time period when electricity supply is available	Supply must, in normal supply circumstances, be continuously available 24 hours each day.	If a Customer has elected to receive 24 hour Continuous Supply and is charged on the basis of the relevant uncontrolled supply Price Category or Price Option in accordance with Schedule 7, the Distributor must maintain continuous electricity supply in accordance with this Agreement. Eligibility requirements for this category of electricity supply, including Metering Equipment requirements, are specified in Schedule 7.
2. CONTROLLED ELECTRICITY SUPPLY CATEGORIES		
2.1 19 hour Controlled Supply: Time period when electricity supply is available	Supply must, in normal supply circumstances, be available for a minimum of 19 hours each day.	If a Customer has elected to receive 19 hour Controlled Supply and is charged on the basis of the relevant Controlled Supply Price Category or Price Option in accordance with Schedule 7, the Distributor may control the relevant part of the Customer's load for a maximum period of 5 hours on any day. The Customer's controlled appliances must be connected (and remain connected) to a load control relay that operates as specified in Schedule 7. Metering Equipment requirements for this category of supply are specified in Schedule 7.
2.2 Controlled Night Supply with afternoon boost: Time period when electricity supply is available	Supply must, in normal supply circumstances, be available in the following time periods: <ul style="list-style-type: none"> • 11 pm to 7 am • 1 pm to 3 pm. At other times the supply is De-energised.	If a Customer has elected to receive supply only within the specified time periods and be charged on the basis of the relevant controlled supply Price Category or Price Option in accordance with Schedule 7, the Distributor must provide the appropriate load control signals to switch the supply. The controlled appliances must be connected (and remain connected) to a load control relay that operates in response to the load control signal, as specified in Schedule 7. Metering Equipment requirements for this category of supply are specified in Schedule 7.

SERVICE MEASURE	SERVICE LEVEL	CONDITIONS
2.3 Controlled Supply for Street Lights: Time period when electricity supply is available	Supply to street light circuits must, in normal supply circumstances, be continuously available during the hours of darkness every day.	If the Customer has elected to receive a streetlight controlled supply and is charged on the basis of the relevant controlled supply Price Category or Price Option in accordance with Schedule 7, the Distributor must provide appropriate load control signals to switch the supply. Street lights must be connected (and remain connected) to a load control relay that is programmed to receive load control signals in accordance with the method(s) specified in Schedule 7. The hours of supply must be set and controlled in accordance with the Customer's requirements.

SERVICE MEASURE	SERVICE LEVEL	CONDITIONS	SERVICE GUARANTEE PAYMENT
3. SERVICE INTERRUPTIONS			
3.1 Time period for restoration of supply: Unplanned Service Interruptions	The Distributor must: Urban: restore supply within 3 hours following notification of an Urban Unplanned Service Interruption; Rural: restore supply within 6 hours following notification of a Rural Unplanned Service Interruption; and Remote Rural: restore supply within 12 hours following notification of a Remote Rural Unplanned Service Interruption.	For the purpose of this Service Measure: Urban means [Distributor to define geographically]; Rural means [Distributor to define geographically]; and Remote Rural means [Distributor to define geographically].	\$50 in respect of each ICP up to 60 A per phase directly affected by the Unplanned Service Interruption, plus a further \$50 for each complete 24hr period in excess of the time limit, subject to the general limit of liability. \$150 in respect of each ICP greater than 60 A per phase directly affected by the Unplanned Service

SERVICE MEASURE	SERVICE LEVEL	CONDITIONS	SERVICE GUARANTEE PAYMENT
			<i>Interruption, plus a further \$150 for each complete 24hr period in excess of the time limit, subject to the general limit of liability.</i>
3.2 Frequency of Service Interruptions	<i>Urban: No more than 4 per annum recorded by the Distributor or reported by the Customer; Rural: No more than 10 per annum recorded by the Distributor or reported by the Customer; and Remote Rural: No more than 20 per annum recorded by the Distributor or reported by the Customer.</i>	<i>The Service Measure includes Service Interruptions caused, or contributed to, by Transmission Interruptions.</i>	
4. POWER QUALITY			
4.1 Frequency of voltage sags	<i>Urban: No more than 30 per annum recorded by the Distributor or reported by 1 or more Customers; Rural: No more than 40 per annum recorded by the Distributor or reported by 1 or more Customers; and Remote rural: No more than 50 per annum recorded by the</i>	<i>A voltage sag occurs when the supply voltage falls below 90% of the nominal supply voltage other than in the case of a momentary fluctuation. If no suitable means of measurement of voltage is permanently available (such as by advanced metering functionality), supply voltage must only be measured in response to a Customer complaint. Includes voltage sags caused, or contributed to,</i>	

SERVICE MEASURE	SERVICE LEVEL	CONDITIONS	SERVICE GUARANTEE PAYMENT
	<i>Distributor or reported by 1 or more Customers.</i>	<i>by Transmission Interruptions.</i>	
4.2 Steady state supply voltage range	<i>Maintain voltage within $\pm 6\%$ of nominal voltage at each point of supply.</i>	<i>Excludes momentary fluctuations. If no suitable means of measurement is permanently available (such as by advanced metering functionality), supply voltage must only be measured in response to a Customer complaint. Includes voltage excursions caused, or contributed to, by Transmission Interruptions.</i>	
5. INVESTIGATIONS OF CUSTOMER COMPLAINTS			
5.1 Power quality, reliability and safety investigations	<i>The Distributor must, no later than 5 Working Days after receiving notification from the Trader or a Customer of a complaint about power quality, supply reliability or safety, investigate the complaint and respond to the Trader and/or Customer as appropriate. The response must indicate the Distributor's findings related to the complaint and, if a problem is confirmed, the Distributor's proposed remedy. If the investigation cannot be completed within 5 Working Days, the Distributor must provide within 7</i>	<i>For the purpose of this Service Measure, a power quality problem includes a problem relating to momentary voltage fluctuations, flicker, voltage harmonics, voltage phase imbalance, and voltage sags. However, in any event, the Distributor must complete its investigation and provide information to the Trader so that the Trader can offer a resolution to the Customer within the timelines set out in the Dispute Resolution Scheme. The Distributor must remedy any problems under its control in a timely manner, in accordance with Good Electricity Industry Practice.</i>	<i>\$50 for exceeding any timeframe specified in the Service Level.</i>

<i>SERVICE MEASURE</i>	<i>SERVICE LEVEL</i>	<i>CONDITIONS</i>	<i>SERVICE GUARANTEE PAYMENT</i>
	<i>Working Days an estimate of the time it will take to complete such an investigation and the reason for requiring extra time.</i>		

SCHEDULE 2 – BILLING INFORMATION

Requirements for operational terms:

- 1 This Schedule 2 must set out:
 - (a) the information that must be provided by the Trader to the Distributor so that the Distributor can calculate Distribution Services charges and prepare Tax Invoices;
 - (b) the formats, procedures, and timeframes for providing the information; and
 - (c) how the Distributor calculates Distribution Services charges.
- 2 The clauses to be included in this Schedule 2 must provide that when exchanging information to which EIEP1, EIEP2, or EIEP3 applies, the Distributor and the Trader will comply with the relevant EIEP.
- 3 Examples of clauses that may comply, and notes explaining the situations in which the clauses could be used, are set out in clause S2.1. Revise as appropriate and then delete this dashed box.

S2.1 Calculating Tax Invoices for Distribution Service charges:

Note: This clause is appropriate for ICP-priced Distribution Services. This clause assumes that the Distributor will create the Tax Invoice. A different clause is required if a buyer-created invoice is required by the Distributor.

The Trader must provide consumption information to the Distributor, and the Distributor must calculate Distribution Services charges payable by the Trader, in accordance with the following:

- (a) the Trader must provide to the Distributor all information that the Distributor reasonably requires to enable it to calculate the Distribution Services charges payable by the Trader to the Distributor in accordance with [EIEP1][, EIEP2] [and EIEP3];
- (b) the Trader must provide the information by the dates and times specified in the relevant EIEP;
- (c) the parties acknowledge that the Distributor's Pricing Structure is based on the Distributor receiving consumption volume information from the Trader using:

Note: Select from the following alternative clauses as relevant to the circumstances.

- (i) [the EIEP1 replacement RM normalised reporting methodology for information in respect of mass market ICPs for which the Distributor has specified time-blocked periods for the application of Prices;]
- (ii) [the EIEP1 as-billed reporting methodology for information in respect of half hour ICPs for which the Distributor has specified time-blocked periods for the application of Prices;]
- (iii) [summary consumption information as described in EIEP2; and]
- (iv) [information in respect of half hour ICPs as described in EIEP3 for which the Distributor has specified half hour metering information for the application of Prices, or where time blocked periods are specified by the Distributor for the application of Prices and the Trader has agreed in writing to the provision of half hour metering information; and]
- (d) the Distributor must calculate the charges based on the Prices that apply to each chargeable quantity to which the Tax Invoice relates.

Note: include this additional sentence if relevant.

[In respect of replacement RM normalised consumption information, the Trader must provide revised consumption information to the Distributor in accordance with EIEP1[, EIEP2][, or EIEP3], as relevant.]

Note: This clause is appropriate for GXP-priced Distribution Services.

[The Trader must provide consumption information to the Distributor, and the Distributor must obtain reconciliation information from the reconciliation manager and calculate Distribution Services charges payable by the Trader, in accordance with the following:

- (a) the Distributor must arrange for the reconciliation manager to provide the Distributor with reconciliation information attributable to the Trader and other relevant information that, subject to paragraph (b), the Distributor reasonably requires to enable it to calculate its Tax Invoice for Distribution Services charges payable by Trader. The Trader must, if necessary, advise the reconciliation manager that the Trader agrees to the Distributor obtaining its reconciliation information;*
- (b) the Trader must provide to the Distributor, no later than 5 Working Days after the end of each month, any information additional to that obtainable by the Distributor from the reconciliation manager that the Distributor reasonably requires to enable it to calculate its Tax Invoice for Distribution Services charges payable by Trader. Such information must be provided in accordance with the relevant EIEP; and*
- (c) the Distributor must calculate the charges based on the Prices that apply to each quantity to which the Tax Invoice relates.]*

SCHEDULE 3 – ELECTRICITY INFORMATION EXCHANGE PROTOCOLS

S3.1 The Distributor and the Trader must comply with the following EIEPs when exchanging information to which the relevant EIEP applies:

- (a) EIEP1 – Detailed ICP billing and volume information;
- (b) EIEP2 – Aggregated billing and volume information;
- (c) EIEP3 – Half hour metering information;
- (d) EIEP5A – Planned service interruptions;
- (e) EIEP12 – Tariff rate change information; and
- (f) any other EIEP publicised by the Authority under the Code with which the Distributor and Trader are required to comply.

Requirements for operational terms: In addition to the EIEPs specified in Clause S3.1, the Distributor must set out any other EIEPs with which the Distributor and Trader must comply when exchanging information to which the relevant EIEP applies. An example is provided in clause S3.2. Revise as appropriate and then delete this dashed box.

S3.2 In addition to the EIEPs specified in clause S3.1, the Distributor and the Trader must comply with the following EIEPs when exchanging information to which the relevant EIEP relates:

- (a) EIEP4 – Customer information;
- (b) EIEP5B – Unplanned service interruptions;
- (c) EIEP6 – Fault notification and service requests;
- (d) EIEP7 – General installation status change;
- (e) EIEP8 – Notification of network price category and tariff change;
- (f) EIEP9 – Customer location address change notification; and
- (g) EIEP11 – New connections information.

SCHEDULE 4 – SYSTEM EMERGENCY EVENT MANAGEMENT

Requirements for operational terms: *This Schedule 4 must set out the Distributor’s System Emergency Event management policy, which is a policy for managing load on the Network during a System Emergency Event.*

The policy must include the Distributor’s priorities, including if relevant, priorities specific to Customer categories and Network localities, for:

- (a) Load Shedding;*
- (b) the use of any controllable load available to the Distributor in accordance with clause 5; and*
- (c) the restoration of load.*

Complete this Schedule and then delete this dashed box.

SCHEDULE 5 – SERVICE INTERRUPTION COMMUNICATION REQUIREMENTS

Unplanned Service Interruptions

Requirements for recorded terms: *If the Distributor must meet any Unplanned Service Interruption Standards when providing Distribution Services, this section must set out:*

- (a) *the information that the Distributor must provide to the Trader if the Distributor becomes aware of 1 or more Unplanned Service Interruptions caused by an area Network fault (being a Network fault that affects a group of customers within an area) or a System Emergency Event, including identifying the affected area or areas and the expected time for restoration of electricity supply in each area;*
- (b) *requirements related to provision by the Distributor of updated information about the status of Unplanned Service Interruptions, including:*
 - (i) *if the Distributor expects that previously advised restoration times will change; and*
 - (ii) *confirmation of areas restored and areas that remain without electricity supply;*
- (c) *whether the Trader or the Distributor is responsible for receiving and managing Unplanned Service Interruption calls from Customers and managing further communication with affected Customers until electricity supplies are restored, and the parties' obligations to exchange information; and*
- (d) *the situations that would trigger the Distributor's public and media communications processes and the communications channels and methods the Distributor uses when communicating with the public and media.*

Examples of clauses that may comply are set out in clauses S5.1 to S5.10. Revise as appropriate and then delete this dashed box.

If any timeframes within which the Distributor must take any particular actions are included in this section, those timeframes must be treated as recorded terms (and not operational terms). The relevant clauses will only be treated as recorded terms to the extent that they impose any timeframes on the Distributor.

S5.1 The Distributor must provide the Trader with information about an Unplanned Service Interruption [affecting 20 or more Customers] that enables the Trader to respond in an informed manner to calls from affected Customers.

S5.2 The Distributor must provide information under clause S5.1 as soon as reasonably practicable after first becoming aware of the Unplanned Service Interruption and:

- (a) *for Unplanned Service Interruptions that occur in staffed control room hours, no later than 10 minutes after the Distributor becomes aware of the interruption; and*
- (b) *for Unplanned Service Interruptions that occur in on-call control room hours, no later than 40 minutes after the Distributor becomes aware of the interruption.*

S5.3 The information provided under clause S5.1 must:

- (a) *be provided by electronic file transfer in accordance with EIEP5B; and*
- (b) *include, if known, a description of the reason for the interruption, the area affected, and an expected time for restoration.*

S5.4 Unless otherwise agreed, the Distributor must, within 10 minutes of new information about an Unplanned Service Interruption becoming available and at intervals of no

longer than 60 minutes, provide the Trader with an update of the status of the Unplanned Service Interruption, until a firm restoration time has been advised by the Distributor to the Trader.

S5.5 If the expected restoration time advised by the Distributor to the Trader is likely to be exceeded, the Distributor must endeavour to inform the Trader of the new expected restoration time at least 10 minutes before the expected restoration time elapses.

S5.6 Unless otherwise agreed, no later than 10 minutes after a full or partial restoration of supply, the Distributor must provide the Trader with details of the areas restored.

S5.7 The Trader must, within 10 minutes of receiving information relating to a possible Unplanned Service Interruption, log the call with the Distributor by electronic file transfer, or by any other information exchange method agreed by the parties. The Distributor must advise the Trader if the Trader should stop logging calls.

S5.8 The Trader may provide the Distributor's contact details to the Customer rather than taking details and logging the call with the Distributor.

S5.9 The Distributor must implement its public and media communication process in the following situations:

- (a) a significant Unplanned Service Interruption that exceeds, or is expected to exceed, 30 minutes in duration, and that affects (without limitation):*
 - (i) more than 1,000 customers;*
 - (ii) a central business district;*
 - (iii) an industrial area;*
 - (iv) supply to critical facilities such as hospitals, pumping stations, dairy farms; or*
 - (v) the Network to such an extent that a disaster recovery plan should be triggered by a severe storm or natural disaster;*
- (b) a Civil Defence emergency has been initiated (in such situation communication may be via Civil Defence Headquarters);*
- (c) any other major event that has a material adverse effect on the delivery of Distribution Services; or*
- (d) if the Distributor is contacted by media for comment regarding an Unplanned Service Interruption.*

S5.10 The Distributor notes that it may use any or all of the following means of communication, as the circumstances require:

- (a) media releases and interviews; and*
- (b) status information and updates on the Distributor's:*
 - (i) automated telephone information service;*
 - (ii) website;*
 - (iii) smartphone app;*
 - (iv) Facebook page; and*
 - (v) Twitter account.*

Planned Service Interruptions

Requirements for recorded terms: *If the Distributor must meet any Planned Service Interruption Standards when providing Distribution Services, this section must set out the parties' obligations and the process that must be followed to notify Customers if the Distributor wishes to undertake a Planned Service Interruption.*

If the Trader is the party that must notify Customers of a Planned Service Interruption, this section must set out:

- (a) the information the Distributor must provide to the Trader if the Distributor wishes to undertake a Planned Service Interruption, which must include:
 - (i) the ICP identifiers of the affected ICPs; and*
 - (ii) the information exchange format and procedure with which the parties must comply;**
- (b) the process and timeframes the Trader must comply with when notifying affected Customers for which it is responsible of the Planned Service Interruption;*
- (c) a process for the Trader to request an alternative date and time for the Planned Service Interruption and for the Distributor to consider such requests; and*
- (d) the steps the Distributor must take if it intends to undertake a Planned Service Interruption on an urgent basis; and*
- (e) whether or not the Distributor must meet the reasonable costs incurred by the Trader in notifying Customers of Planned Service Interruptions.*

If the Distributor is the party that must notify Customers of a Planned Service Interruption, this section must set out:

- (a) the process the Distributor must follow to obtain Customer information held by the Trader that is necessary to enable the Distributor to provide notifications about Planned Service Interruptions;*
- (b) the information the Distributor must provide to Customers affected by the Planned Service Interruption; and*
- (c) the information the Distributor must provide to the Trader about the Planned Service Interruption, including the:
 - (i) affected ICP identifiers;*
 - (ii) amount of notice given to Customers; and*
 - (iii) the information exchange format and procedure with which the parties must comply.**

Examples of clauses that may comply are set out in clauses S5.11 to S5.19. Revise as appropriate and then delete this dashed box.

If any timeframes within which the Distributor must take any particular actions are included in this section (for example, if the Distributor is required to give the Trader a minimum period of notice for a Planned Service Interruption), those timeframes must be treated as recorded terms (and not operational terms). The relevant clauses will only be treated as recorded terms to the extent that they impose any timeframes on the Distributor.

Note: The 2 options below reflect common arrangements. If a hybrid arrangement operates (eg, Trader notifies normally but Distributor's contractor notifies directly affected customers for small jobs, say < 20 ICPs) suitable additional clauses must be added.

Option A – Trader to notify Customers

S5.11 The Distributor must provide the Trader with notice of a Planned Service Interruption in accordance with the relevant EIEP at least 10 Working Days prior to the date on which the Planned Service Interruption is scheduled, including the ICP identifiers that

the Distributor's information system indicates will be affected by the Planned Service Interruption. On receipt of such notice, the Trader must promptly notify affected Customers for which it is responsible of the Planned Service Interruption.

S5.12 The Trader may no later than 2 Working Days after receipt of such notice, notify the Distributor of any Customers who would be adversely affected by the interruption and request an alternative date and/or time for the Planned Service Interruption.

S5.13 If the Distributor receives a request from the Trader for an alternative date and/or time for the Planned Service Interruption, the Distributor must consider in good faith the request and may, in its sole discretion, change the time and/or date of the Planned Service Interruption. If the Distributor makes such a change, the Distributor must provide the Trader with notice of the new date and/or time at least 7 Working Days before the original date of the Planned Service Interruption.

S5.14 If a Planned Service Interruption is necessary on a more urgent basis for reasons of emergency repairs, the Distributor must provide the Trader with a notice of the Planned Service Interruption in accordance with clauses S5.11 as soon as reasonably practicable.

S5.15 If the Planned Service Interruption will affect all customers supplied from a Network Supply Point, the Distributor may, in addition to providing the notices required in clauses S5.11, S5.13 and S5.14, arrange for public notification through a local newspaper, or other effective method, on behalf of all traders.

S5.16 The Distributor must meet the reasonable costs incurred by the Trader in notifying Customers of Planned Service Interruptions.

Option B – Distributor to notify Customers

S5.17 If required, and despite the terms of an agreement between the parties on the terms set out in Appendix C of Schedule 12A.1 of the Code (if applicable), the Trader must provide Customer contact information to the Distributor on a monthly basis. The information must be provided in accordance with EIEP4. Any information provided by the Trader to the Distributor under this clause will be Confidential Information.

S5.18 For all Planned Service Interruptions, the Distributor must provide each of the Customers it identifies as being affected with a notice specifying the time and date of the Planned Service Interruption and the reason for the interruption at least 4 Working Days before the date on which the Planned Service Interruption is scheduled.

Note: One factor that the Distributor may wish to consider is whether the timeframe in clause S5.18 may need to be longer than 4 Working Days if, for example, the Trader elects to provide its own written/telephone notification to medically dependent customers that would be affected by the Planned Service Interruption.

S5.19 The Distributor must provide the Trader with notice of the Planned Service Interruption in accordance with EIEP5 at least 4 Working Days before the Planned Service Interruption is scheduled to occur.

SCHEDULE 6 – CONNECTION POLICIES

Requirements for operational terms: *This Schedule 6 must set out the parties' obligations and the processes that must be followed related to the management of Network connections. This Schedule 6 must set out comprehensive processes for facilitating:*

- (a) new connections to the Network;*
- (b) capacity changes to existing connections;*
- (c) Temporary Disconnections and associated reconnections;*
- (d) Vacant Site Disconnections and associated reconnections; and*
- (e) Decommissioning.*

Examples of clauses that may comply are set out in clauses S6.1 to S6.27. Revise as appropriate and then delete this dashed box.

If any timeframes by which the Distributor must take particular actions are included in this Schedule 6, those timeframes must be treated as recorded terms (and not operational terms).

Introduction

S6.1 This Schedule sets out the processes that the Distributor and Trader must follow in respect of facilitating:

- (a) new connections to the Network;*
- (b) capacity changes to existing connections;*
- (c) Temporary Disconnections and associated reconnections;*
- (d) Vacant Site Disconnections and associated reconnections; and*
- (e) Decommissioning.*

Process for new connections or changes in capacity

S6.2 The Distributor may receive applications from:

- (a) the owner of a premises not currently connected to the Network or the owner's agent that is or intends to be a Customer (the "Requesting Party"), or the Trader on behalf of a Requesting Party, for a new connection to be created; and*
- (b) a Customer (the "Requesting Party"), or the Trader on behalf of a Requesting Party, for an increase or decrease in the capacity of an existing connection.*

S6.3 The Distributor must undertake an impact assessment to determine whether the capacity required for the connection is already available or whether a Network upgrade is required. If, acting reasonably, the Distributor considers that a Network upgrade is required, or that other works are required, the Distributor must advise the Requesting Party of the terms on which the Distributor is prepared to undertake the necessary works. If the application is declined the Distributor must provide the reasons for its decision.

S6.4 If the Distributor and Requesting Party agree on terms under which the Distributor will supply a new connection or change the capacity of an existing connection, the Distributor must advise the Trader of the following no later than 2 Working Days after agreement was reached (provided that the Distributor knows that the Requesting Party is a Customer):

- (a) the ICP identifier for the new connection;*
- (b) the NSP to which the ICP is or will be connected; and*
- (c) the allocated Price Category, provided that if the ICP is eligible for more than 1 Price Category, the Trader may advise the Distributor of its preferred Price*

Category in accordance with clause 8.4.

S6.5 The Distributor or the Trader (if authorised by the Distributor) must arrange for the ICP to be electrically connected to the Network by a Warranted Person once approval has been granted by the Distributor. The party that undertakes the electrical connection to the Network must, unless otherwise agreed, notify the other party within 2 Working Days of the ICP being electrically connected, and provide to the other party a copy of a certificate of compliance and record of inspection for the site under the Electricity (Safety) Regulations 2010, where relevant.

Timeframe for electrically connecting standard new connections

S6.6 A standard new connection must be electrically connected to the Network within 2 Working Days following a request by the Trader if:

- (a) all necessary equipment is in place;*
- (b) Network upgrades or extensions are not required; and*
- (c) all other necessary requirements are met.*

S6.7 The timeframe for electrically connecting an ICP that does not meet the requirements set out in clause S6.6 must be agreed by the parties.

Temporary Disconnections and associated reconnections

Note: Clauses S6.8 – S6.22 provide that either party may carry out Temporary Disconnections in specified circumstances.

Clause 17.3 provides that only a Warranted Person may undertake connection or disconnection work that requires access to any Distributor's Equipment (such as a pole or pillar fuse or isolation link). This would not prevent a Trader from undertaking a Temporary Disconnection using a method that does not involve access to the Network (eg, using suitable advanced Metering Equipment functionality, removing conductors from meter terminals and resealing the meter, or locking open a suitable isolation device located within the Customer's Premises).

S6.8 The parties agree that Temporary Disconnection of an ICP at which the Trader supplies electricity may be carried out by the Trader in the following circumstances:

- (a) if in an emergency it is necessary to avoid endangering persons or property;*
- (b) for credit reasons; or*
- (c) if requested by the Customer, for safety or other reasons.*

S6.9 The Trader must, subject to clause 29.1, ensure that each of its Customer Agreements provides that the Distributor may perform a Temporary Disconnection in relation to a Customer's ICP in the following circumstances:

- (a) it is necessary to avoid endangering persons or property;*
- (b) there has been an occurrence, or there are circumstances, that may adversely affect the proper working of the Network or the Grid;*
- (c) in the circumstances set out in clause 3.7;*
- (d) in accordance with clause 11.3;*
- (e) if a Customer does any of the things prohibited under clauses 12.1 or 12.7, or fails to do any of the things required of it as contemplated in clause 13; or*
- (f) on termination of this Agreement.*

S6.10 Subject to clause 17.4 (which relates to medically dependent and vulnerable Customers), if the Distributor intends to perform a Temporary Disconnection under clause S6.9, the Distributor must give the Trader notice of the Temporary Disconnection as follows:

- (a) *the Distributor must give the Trader at least 5 Working Days' notice of disconnection if the Distributor intends to perform a Temporary Disconnection because:*
 - (i) *the Customer failed to provide the Distributor with access in accordance with its Customer Agreement; or*
 - (ii) *the Customer damaged or interfered with the Distributor's Equipment or Network; or*
- (b) *the Distributor must give the Trader at least 10 Working Days' notice of disconnection if the Distributor intends to perform a Temporary Disconnection because the Customer failed to do any of the things required of it as contemplated in clause 11.*

S6.11 The notice of Temporary Disconnection provided by the Distributor to the Trader under clause S6.10 must specify:

- (a) *the ICP identifier of the relevant Customer;*
- (b) *the particulars of the Customer breach;*
- (c) *the remedy required if disconnection is to be avoided; and*
- (d) *the date on which disconnection will occur if the breach is not previously remedied to the Distributor's reasonable satisfaction.*

S6.12 On receipt of a notice under clause S6.10, the Trader must promptly forward a physical notice to the relevant Customer and include mail, email and telephone contact details that the Customer may use to contact the Trader about the matter. The Trader must promptly forward to the Distributor any response received from the Customer and the Distributor must consider in good faith all such responses it receives. The Trader and the Distributor must work together to ensure that communications are co-ordinated and promptly communicated to the relevant party.

S6.13 Subject to clause 17.4 (which relates to medically dependent and vulnerable Customers):

- (a) *if the Distributor intends to perform a Temporary Disconnection under clause S6.9(f), the grounds for the Temporary Disconnection are not being reasonably Disputed by the Trader, and the Distributor has taken reasonable steps to avoid the need for a Temporary Disconnection, the Distributor must give each Customer:*
 - (i) *at least 9 Working Days' notice of warning of disconnection before any disconnection, such notice to include the reason for the Temporary Disconnection and be sent to each Customer's last address provided to the Distributor by the Trader, or if no address has been provided as the Trader has no Customer at that ICP, the notice must be sent to the Customer's address on the Registry, and the Distributor must provide information about the Temporary Disconnection by way of general advertisement and publication on the Distributor's website;*
 - (ii) *a final warning not less than 48 hours nor more than 7 days before the disconnection. The final warning must provide the timeframes for disconnection. This must be a separate notice to the notice provided at least 9 Working Days before disconnection;*
 - (iii) *if disconnection is not completed within the timeframes notified, the Distributor must issue another final warning not less than 48 hours nor*

more than 7 days before disconnection:

- (b) *if the Distributor intends to perform a Temporary Disconnection as contemplated by clause S6.9(a) or S6.9(b), the Distributor must use its best endeavours to give each Customer as much prior notice as reasonably practicable, but in any event must notify each Customer no later than 2 days after the Temporary Disconnection.*

S6.14 The party that performs a Temporary Disconnection in respect of a Customer must (unless otherwise agreed) notify the other party of that fact no later than 2 Working Days after the Temporary Disconnection. To avoid doubt, the status of the ICP in the Registry must be changed to "inactive" only if the Temporary Disconnection remains in effect for more than 5 Working Days.

S6.15 If either party has performed a Temporary Disconnection in respect of a Customer's ICP, the party that performed the Temporary Disconnection must take reasonable steps to arrange restoration of supply to the ICP as soon as reasonably practicable and in any case:

- (a) *no later than 3 Working Days after conditions for reconnection have been satisfied; or*
(b) *by any other date agreed with the Customer.*

Vacant Site Disconnections and associated reconnections

S6.16 The Trader may undertake a Vacant Site Disconnection of an ICP if:

- (a) *the Trader is recorded as the trader for the ICP in the Registry;*
(b) *the ICP has an "active" status in the Registry; and*
(c) *in respect of that ICP, no Customer Agreement exists with the Trader.*

S6.17 The Trader must undertake a Vacant Site Disconnection of an ICP without delay if the ICP meets the criteria set out in clause S6.16 and the ICP has been inactive for at least 30 Working Days.

Note: Clause S6.18 assumes that the Distributor has no interest in the energisation status of any ICP. If it does, additional provisions will be needed.

The second sentence of clause S6.18 is written to ensure proof of compliance with the requirements of regulation 74(3) of the Electricity (Safety) Regulations 2010.

S6.18 The Trader may reconnect an ICP that is subject to a Vacant Site Disconnection if it wishes to supply electricity to that ICP. If the ICP has not been electrically connected for more than 6 months, the Trader must either request an inspection from the Distributor (if the Distributor provides this service) or advise the Customer to procure its own safety inspection using a person authorised to certify mains work. A copy of the certificate issued following such an inspection must either be provided to the Distributor, or held by the Trader at the Trader's offices for the later inspection by the Distributor, before the ICP is Re-energised.

S6.19 The Trader must ensure that Vacant Site Disconnections and associated reconnections are carried out in accordance with the Distributor's reasonable operational work practices for managing vacant sites. If a Vacant Site Disconnection or the associated reconnection requires access to any Network equipment or Distributor's Equipment, it must be carried out by a Warranted Person.

S6.20 The Trader may give the Distributor notice that the Distributor is responsible for completing the Vacant Site Disconnection for an ICP if:

- (a) *the Trader wishes to carry out a Vacant Site Disconnection for the ICP;*

- (b) *the Distributor has not provided an exclusive and accessible isolation device for that ICP; and*
- (c) *the Trader has not been able to complete a Vacant Site Disconnection in accordance with Good Electricity Industry Practice for that ICP after 2 separate site visits for that purpose by a Warranted Person, including by seeking to disconnect at the ICP at the meter(s).*

S6.21 If the Trader gives the Distributor notice under clause S6.20:

- (a) *the Distributor must endeavour in accordance with Good Electricity Industry Practice to complete the Vacant Site Disconnection;*
- (b) *the Distributor must investigate provision of an accessible isolation device for the ICP but is not required to install such a device if it considers in its opinion that it would be impractical or unreasonably costly to do so; and*
- (c) *the Trader must continue to use reasonable endeavours to seek to gain access to the ICP meter to meet its obligations under the Code.*

S6.22 The party performing the disconnection or reconnection must, unless otherwise agreed, notify the other party within 2 Working Days after completion of the work.

Decommissioning an ICP

S6.23 A Distributor may Decommission an ICP in the following circumstances, provided that the requirements of section 105 of the Act and Part 11 of the Code are met:

- (a) *the Distributor is advised by a Customer, landowner or the Trader that electricity is no longer required at the ICP;*
- (b) *it is necessary to Decommission the ICP because public safety is at risk;*
- (c) *the Registry notifies the Distributor that the ICP has the status of "Inactive", with the reason given "De-energised – ready for decommissioning", the ICP has been De-energised and the Trader has attempted to recover any Metering Equipment;*
or
- (d) *if the Distributor has not provided Distribution Services in respect of the ICP for 6 months or more.*

S6.24 If a Distributor intends to Decommission and clauses S6.23(a) or (d) apply, the Distributor must, unless advised by the Trader, notify the Trader before Decommissioning the ICP to enable the Trader to arrange for removal of the Metering Equipment (if appropriate) and update the Registry.

S6.25 A party Decommissioning an ICP must do so by removing all or part of the Customer Service Line to the ICP, or if a shared Customer Service Line forms part of the supply, by isolating and removing the load side cable from the main switch at the meter board. In all circumstances, the property must be left electrically safe.

S6.26 If an ICP has the status of "Decommissioned" on the Registry, the ICP identifier must not be used again and the process for new connections must be followed if supply is required again at the property.

SCHEDULE 7 – PRICING

Requirements for operational terms: *This Schedule 7 must set out how the Trader can access information that provides comprehensive policy and detail of the Distributor's current:*

- (a) Pricing Structure;*
- (b) Price Categories, and the eligibility criteria for each Price Category;*
- (c) Price Options (if any); and*
- (d) Prices.*

Complete this Schedule and then delete this dashed box.

SCHEDULE 8 – LOAD MANAGEMENT

Use of controllable load

S8.1 A party may use a Load Control System for 1 or more of the following purposes, which are ranked in order of priority, provided that it has obtained the right to control the load in accordance with clause 5.1 or 5.2:

- (a) **Grid Emergency:** As defined in Part 1 of the Electricity Industry Participation Code 2010;
- (b) **Market participation:** Any other right to control load.

S8.2 If both parties have obtained the right to control parts of the consumer's load in accordance with clause 5.1 or 5.2, and both parties want to control load for a purpose specified in clause S8.1 at the same time, the party entitled to control load will be the party with the higher priority rank as specified in clause S8.1.

Requirements for operational terms: If relevant, this section must set out the rights and obligations of the parties in respect of coordination of split ownership Load Control Systems. An example of a clause that may comply is set out in clause S8.3. Revise as appropriate and then delete this dashed box

Coordination of split ownership Load Control Systems

Note: Coordination is required if the Load Signalling Equipment and Load Control Equipment in a Load Control System is provided by more than 1 party. For legacy Load Control Systems in New Zealand, this normally involves the Distributor providing the Load Signalling Equipment and the Trader providing the Load Control Equipment.

S8.3 *If the Trader provides Load Control Equipment that forms part of the Distributor's Load Control System, the following provisions apply:*

- (a) *The Distributor must provide the Trader with details of the technical characteristics of the Load Control Equipment appropriate for use with the Distributor's Load Signalling Equipment in each Network area.*
- (b) *If the Distributor has obtained a load control right in accordance with clause 5.1, the Trader must ensure that Load Control Equipment is installed that reliably receives the Distributor's load control signals and controls the relevant load. If the Distributor's specific Controlled Load Option makes it necessary for the Trader to install additional Metering Equipment that separately measures and records controlled load electricity consumption, the Trader must install the Metering Equipment (provided that the parties acknowledge that such installation does not give the Distributor the right to change the eligibility criteria for Price Categories or Price Options in a manner that would require a mass change to existing metering installations).*
- (c) *If the Distributor seeks to change the operating characteristics (including the signalling frequency or protocol) of its Load Signalling Equipment, the Trader and Distributor must first negotiate in good faith to agree suitable terms for the upgrade of the Trader's Load Control Equipment. If agreement is not reached, the Distributor may, at its discretion, elect to procure and install, at its own cost, suitable Load Control Equipment.*
- (d) *The Distributor may periodically, but not more than once in any 12 month period, undertake an audit of Load Control Equipment performance within a Network*

area of its choice. The audit must assess the proper functioning of the Load Control Equipment for a randomly selected sample of ICPs to which the Trader supplies electricity. The sampling technique must be consistent with the methodology outlined in Part 10 of the Code that applies to selecting samples of meters.

- (e) If the audit finds that Load Control Equipment for which the Trader is responsible is not functional in respect of a number that is greater than 5% of the sample, the Distributor and Trader must, within 40 Working Days of the Distributor notifying the Trader of the results of the audit, meet and agree a programme of work including scope and timeframe within which the non-functioning Load Control Equipment must be identified and either replaced or repaired. The Trader must pay the reasonable costs of any inspection (including the initial audit) and repair work identified.*
- (f) If the audit reveals that the proper functioning of Load Control Equipment is caused by low signal levels or faults on a pilot wire network that are the responsibility of the Distributor, such failures must be excluded from the audit results.*
- (g) If the audit finds that Load Control Equipment for which the Trader is responsible is functional for 95% or more of the ICPs sampled, the cost of the audit must be paid by the Distributor, but the Trader must remedy all defects found in respect of non-functional Load Control Equipment for which the Trader is responsible.*

Electricity Industry Participation Code 2010

Part 13 Trading arrangements

Contents

- 13.1 Contents of this Part
- 13.2 Misleading, deceptive, or incorrect information
- 13.2A Participant must make disclosure information readily available
- 13.3 Approval process for industrial co-generating stations
- 13.3A Approval process for dispatch-capable load stations
- 13.2B Submission of quarterly disclosure reports by major participants
- 13.2C Specific requirements under clause 13.2B
- 13.2D Timing and form of quarterly disclosure reports under clause 13.2B
- 13.2E Publication of information in quarterly disclosure reports by the Authority
- 13.2F Use of information in quarterly disclosure by the Authority
- 13.2G Authority may require review of disclosure requirements or certification by independent person
- 13.2H Nomination of independent person to undertake review
- 13.2I Factors relevant to a direction under clause 13.2H
- 13.2J Carrying out of review by independent person
- 13.2K Payment of review costs
- 13.2L Requirement to provide complete and accurate information
- 13.3B Purchasers to advise system operator of changes to dispatch-capable load station
- 13.3C System operator to publish dispatch-capable load station approval process guidelines
- 13.3D Access to WITS
- 13.3E Approval process for dispatch notification purchasers
- 13.3F Approval process for dispatch notification generators
- Subpart 1—Bids and offers
- 13.4 Contents of this subpart
- 13.5 Bids and offers must be lawful
- 13.5A Conduct in relation to generators' offers and ancillary service agents' reserve offers
- 13.5B *[Revoked]*
- Bids and offer preparation*
- 13.6 Requirements for generators when submitting offers
- 13.7 Purchaser to submit bids for dispatch-capable load station
- 13.7AA Purchaser to submit bids for non-dispatch-capable load
- 13.7AB Timeframe for submitting bids to system operator
- 13.7AC Submitting bid for first time
- 13.7AD Submitting bid for last time
- 13.7A System operator to prepare forecast of non-dispatch-capable load at conforming GXPs
- 13.7B Authority may request system operator to report on accuracy of forecasts of non-dispatch-capable load at conforming GXPs
- 13.8 Deemed offers

- 13.8A Deemed nominated bids
- 13.8B Deemed reserve offers
- 13.9 Information that offers must contain
- 13.9A Offer not to exceed capability
- 13.9B Offer requirements for intermittent generators
- 13.10 Generators must specify units in offers
- 13.11 Offers may be made by unit or plant
- 13.12 Offers may contain up to 5 price bands
- 13.13 Information to be contained in bids
- 13.14 Nominated bids may contain up to 10 price bands
- 13.14A Difference bids may contain up to 10 price bands
- 13.15 How price is to be specified in bids or offers
- 13.16 How quantity is to be specified in bids or offers
- 13.17 Offers may be revised
- 13.18 When revised offer to be submitted
- 13.18A Intermittent generators to submit revised forecast of generation potential every trading period in last 2 hours
- 13.19 When revised offers may be submitted during gate closure period
- 13.19AA Limitations on revised offers
- 13.19A Bids may be revised
- 13.19B Bids must be revised
- 13.19C Dispatch notification purchasers and dispatch notification generators to submit revised bids and offers in certain circumstances
- 13.20 System operator advised of revised nominated bids or offers in certain circumstances
- 13.21 Authority informed of revised nominated dispatch bid or offer during gate closure period
- 13.22 Transmission of information
- 13.23 Backup procedures if WITS is unavailable
- 13.24 Plant with special circumstances
- 13.25 Exception for small generation
- 13.26 Exception for embedded generation
- 13.27 System operator to retain bids and offers
 - Process for determining conforming and non-conforming grid exit points*
 - 13.27A Authority determines conforming and non-conforming GXPs on own initiative
 - 13.27B Authority to determine conforming and non-conforming GXPs if requested
 - 13.27C Process for making determination
 - 13.27D System operator to provide advice within reasonable time
 - 13.27E Authority may publish criteria for determining GXP to be non-conforming
 - 13.27F GXP deemed to be conforming GXP before determination is made
 - 13.27G Authority must publish and maintain list of non-conforming and conforming GXPs
 - 13.27H Right to request determination or reconsideration of determination
 - 13.27I Effect of determination
 - 13.27J New GXPs
 - 13.27K Authority to provide information at purchaser's request

Special treatment of some grid exit points

- 13.28 Special treatment of some grid exit points
Information from grid owners
- 13.29 Standing data on grid capability to be provided to system operator
- 13.30 Standing data on HVDC capability to be provided to system operator
- 13.31 Standing data on transformer capability to be provided to system operator
- 13.32 Transmission grid capability information to be updated
- 13.33 Grid owners must submit revised information to system operator
- 13.34 Changes may be made later than 1 hour before trading period
- 13.35 System operator to confirm receipt of grid owner information
- 13.36 *[Revoked]*

Offering instantaneous reserve

- 13.37 System operator to approve ancillary service agents wishing to make reserve offers
- 13.38 Ancillary service agents to submit reserve offers to system operator
- 13.39 Inter-relationship between reserve and energy offers
- 13.40 Inter-relationship between reserve offers of interruptible load and bids
- 13.40A Inter-relationship between reserve offers and nominated dispatch bids
- 13.41 Reserve offers may contain up to 3 price bands
- 13.42 How price to be specified in reserve offers
- 13.43 *[Revoked]*
- 13.44 How quantity is to be specified in reserve offers
- 13.45 Reserve offers revised if energy offers revised
- 13.46 Reserve offer may be revised
- 13.47 MW change during gate closure period
- 13.48 System operator advised of revised reserve offers in certain circumstances
- 13.49 Authority advised of revised reserve offer during gate closure period
- 13.50 System operator to advise Authority of revision of reserve offers
- 13.51 Transmission of reserve offers
- 13.52 Backup procedures if WITS is unavailable
- 13.53 Additional information to be provided by participants
- 13.54 System operator to retain reserve offers
- 13.55 Availability of bids, offers, and reserve offers
- 13.55A System operator to make information available

Subpart 2—Scheduling and dispatch

- 13.56 Contents of this subpart
- 13.57 The dispatch objective
- 13.58 Process for preparing price-responsive schedule and non-response schedule
- 13.58AA System Operator to assign price and quantity values
- 13.58AB Authority to review price and quantity values
- 13.58A Inputs for price-responsive schedule and non-response schedule
- 13.59 Contents of each price-responsive schedule and non-response schedule
- 13.60 Block dispatch may occur
- 13.61 System operator to give notice of block security constraints
- 13.62 Frequency of price-responsive schedules and non-response schedules
- 13.63 Trading period information to be made available to clearing manager
- 13.64 Station dispatch may occur

- 13.65 System operator to give notice of station security constraints
- 13.66 Generator gives written notice of change from station to unit dispatch
- 13.67 Transmission of information

The dispatch process

- 13.68 *[Revoked]*
- 13.69 *[Revoked]*
- 13.69A System operator to prepare dispatch schedule
- 13.69AA System operator to assign price and quantity values
- 13.69AAA Grid owner to provide real time demand values to system operator
- 13.69B Inputs for dispatch schedule
- 13.69C Contents of each dispatch schedule
- 13.69D System operator to verify accuracy of dispatch prices and dispatch reserve prices
- 13.70 System operator may depart from dispatch schedule
- 13.71 *[Revoked]*
- 13.72 System operator to issue dispatch instructions and dispatch notifications
- 13.72A Dispatch schedule primary modelling system unavailable
- 13.73 Content of dispatch instructions and dispatch notifications
- 13.74 *[Revoked]*
- 13.75 Form of dispatch instruction and dispatch notification
- 13.76 System operator to issue and log dispatch instructions and dispatch notifications
- 13.77 *[Revoked]*
- 13.78 *[Revoked]*
- 13.79 Acknowledgement of dispatch instructions
- 13.80 *[Revoked]*
- 13.81 Backup procedures if communication not possible
- 13.82 Dispatch instructions to be complied with
- 13.82A Compliance with dispatch notifications
- 13.82B Dispatch notification purchasers and dispatch notification generators to provide information
- 13.83 Generators to make staff or facilities available to meet dispatch instructions and dispatch notifications
- 13.83A Dispatchable load purchasers to make staff or facilities available to meet dispatch instructions and dispatch notifications
- 13.84 Ancillary service agents to make staff or facilities available to meet dispatch instructions
- 13.85 Generators have flexibility within block dispatch group or station dispatch group
- 13.86 Generators and ancillary service agents not obliged to comply with dispatch instructions below threshold
- 13.86A Intermittent generators must not substantially reduce generation
- 13.87 *[Revoked]*
- 13.88 *[Revoked]*
- 13.89 *[Revoked]*
- 13.90 *[Revoked]*
- 13.91 *[Revoked]*
- 13.92 *[Revoked]*
- 13.93 *[Revoked]*
- 13.94 *[Revoked]*
- 13.95 *[Revoked]*

13.96 *[Revoked]*

Grid emergencies

13.97 Grid emergency situations

13.98 Generators and ancillary service agents may change other parameters

13.99 Effect of grid emergency on total quantities bid

13.99A *[Revoked]*

13.100 Purchasers may change other parameters

13.101 Reporting requirements in respect of grid emergencies

13.102 Reporting obligations of system operator

System operator to provide and make information available

13.103 *[Revoked]*

13.104 System operator to make information available

13.104A System operator to make information available in respect of dispatch schedule

13.105 *[Revoked]*

13.105A Information to be made available to purchasers, generators, and ancillary service agents

13.106 Transmission of information

Subpart 3—Must-run dispatch auction

13.107 Contents of this subpart

13.108 Clearing manager to hold must-run dispatch auctions

13.109 Clearing manager authorises generators

13.110 Clearing manager must calculate amounts owing

13.111 Purchasers must receive auction revenue

13.112 Clearing manager must calculate amounts receivable

13.113 Generators choose grid injection points at which they will exercise rights conferred

13.114 Transmission of auction information

13.115 Trading in auction rights permitted

13.116 Offers at 0

Must-run auction process

13.117 Clearing manager must conduct auctions

13.118 *[Revoked]*

13.119 Historic load data

13.120 Quantity available for auction

13.121 Notice of auction and deadline for auction bids

13.122 Revising, cancelling and extending auction bids

13.123 Contents of auction bids

13.124 Ranking of auction bids

13.125 Matching auction bids to rights

13.126 Similar and identical auction bids

13.127 Auction payment

13.128 Results

13.129 Authorisation to successful bidders

13.130 Records

Subpart 4—Pricing

13.131 Contents of this subpart

13.132 *[Revoked]*

13.133 *[Revoked]*

13.134 *[Revoked]*

Rules governing the preparation of interim prices

13.134A Methodology for calculating interim prices

13.135 *[Revoked]*

13.135A *[Revoked]*

13.135B *[Revoked]*

13.135C *[Revoked]*

Generators to give grid owner half-hour metering information

13.136 Offered embedded generators to provide half-hour metering information

13.137 Unoffered grid-connected generators and grid-connected type B industrial co-generation to provide half-hour metering information

13.137A Offered grid-connected intermittent generators to provide half-hour metering information

13.138 Generator's half-hour metering information to be adjusted for losses

13.138A *[Revoked]*

13.138B *[Revoked]*

13.138C Generators to arrange for regular audits

13.139 Half-hour metering information part of input information

13.140 Generators to advise grid owner of having provided half-hour metering information

13.140A Generators to resolve issues

13.141 *[Revoked]*

13.141A Grid owner to calculate adjusted load information

13.141B Adjusted load information to be provided to the clearing manager

13.142 *[Revoked]*

13.143 *[Revoked]*

13.144 *[Revoked]*

13.145 Grid owner to give written notice that estimated data given

13.146 *[Revoked]*

13.147 *[Revoked]*

13.148 *[Revoked]*

13.149 *[Revoked]*

13.150 *[Revoked]*

13.151 *[Revoked]*

13.152 *[Revoked]*

13.153 *[Revoked]*

13.154 *[Revoked]*

13.155 *[Revoked]*

13.156 *[Revoked]*

13.157 *[Revoked]*

13.158 *[Revoked]*

13.159 *[Revoked]*

13.160 *[Revoked]*

13.161 *[Revoked]*

13.162 *[Revoked]*

- 13.163 *[Revoked]*
- 13.164 *[Revoked]*
- 13.165 *[Revoked]*
- 13.166 *[Revoked]*
- 13.166A *[Revoked]*

Publication of interim prices

- 13.167 Clearing manager to make interim prices available
 - Pricing error process*
 - 13.168 When pricing error may be claimed or investigated
 - 13.169 *[Revoked]*
 - 13.170 Method and timing for claiming pricing error has occurred
 - 13.170A Clearing manager may investigate potential pricing errors
 - 13.171 *[Revoked]*
 - 13.172 *[Revoked]*
 - 13.173 Process when pricing error claim received
 - 13.173A Process when pricing error investigation commenced
 - 13.173B Clearing manager may request information from error claimant or participant when pricing error claim received or pricing error investigation commenced
 - 13.173C Authority to determine whether pricing error has occurred
 - 13.174 *[Revoked]*
 - 13.175 *[Revoked]*
 - 13.176 *[Revoked]*
 - 13.177 Clearing manager to implement Authority's determination
 - 13.178 Further pricing error may be claimed or investigated in respect of revised interim prices
 - 13.178A Pricing error claim in respect of trading periods prior to 1 November 2022
 - 13.179 *[Revoked]*
 - 13.180 *[Revoked]*
 - 13.181 *[Revoked]*
 - 13.182 *[Revoked]*

Final prices

Making final prices available

- 13.182A Interim prices become final prices if no pricing error claimed or investigated
- 13.182B Interim prices become final prices if no pricing error exists
- 13.183 Final prices not to change
- 13.184 Authority may order delay of interim prices becoming final prices
- 13.185 *[Revoked]*

Miscellaneous requirements relating to calculation of prices

- 13.186 *[Revoked]*
- 13.187 *[Revoked]*
- 13.188 *[Revoked]*
- 13.189 System operator to give Authority list of model variable values
- 13.189A *[Revoked]*
- 13.190 All information and notices to be unconditional and final
- 13.191 Backup procedures if WITS or approved system is unavailable

Calculation of constrained off amounts

- 13.192 Constrained off situations may occur
- 13.192A No constrained off situation for intermittent generating stations
- 13.194 Clearing manager to calculate constrained off amounts
- 13.195 Constrained off amount for block dispatch groups and station dispatch groups
- 13.196 Calculation of constrained off amounts attributable to system operator
- 13.197 Timeframe for calculating constrained off amounts
- 13.198 Clearing manager to send constrained off information to system operator
- 13.199 Clearing manager to make details of constrained off amounts available
- 13.200 Authority, generators and purchasers have rights to constrained off information
- 13.201 Generators do not get paid constrained off compensation
- 13.201A Dispatched purchasers entitled to constrained off compensation and purchasers to pay constrained off compensation

Calculation of constrained on amounts

- 13.202 Constrained on situations may occur
- 13.203 Determining affected price bands for block dispatch groups or station dispatch groups
- 13.204 Calculation of constrained on amounts
- 13.205 Calculation of constrained on amounts attributable to system operator
- 13.206 Timeframe for calculating constrained on amounts
- 13.207 Clearing manager to send constrained on information to system operator
- 13.208 Clearing manager to make details of constrained on amounts available
- 13.209 Authority, generators, ancillary service agents, and purchasers have rights to constrained on information
- 13.210 *[Revoked]*
- 13.211 Backup procedures if the clearing manager's external system is unavailable
- 13.212 Payment of constrained on compensation

No payment of constrained on and off compensation for frequency keeping

- 13.212A No payment of constrained on and off compensation for frequency keeping

No payment of constrained on compensation for generators at maximum ramp down rate

- 13.212B No payment of constrained on compensation for generators at maximum ramp down rate

Pricing manager's reporting obligations

- 13.213 *[Revoked]*
- 13.214 *[Revoked]*
- 13.215 *[Revoked]*
- 13.216 *[Revoked]*

Subpart 5—Hedge arrangement disclosure

- 13.217 Contents of this subpart
- 13.218 Parties required to submit information
- 13.219 Information that must be submitted
- 13.220 Calculation of contract price
- 13.221 Node and grid zone area information
- 13.222 Other information that must be submitted
- 13.223 Modified or amended information
- 13.224 Correction of information
- 13.225 Timeframes for submitting information

- 13.226 WITS manager must make certain information available to the public
- 13.227 Verification of information
- 13.228 Confirmation of information submitted through approved system
- 13.229 Submitting party to check if no confirmation received
- 13.230 Certification of information
- 13.231 Audit of information
- 13.232 Payment of costs relating to audits
- 13.233 WITS manager and Authority must not publish certain information and may use information only under this subpart
- 13.234 No misleading information
- 13.235 Risk management contracts must be lawful
- 13.236 Availability of information
- 13.236AA Requirement to provide consent to exchange
 - Subpart 5A—Spot price risk disclosure
- 13.236A Disclosing participants must prepare and submit spot price risk disclosure statements
- 13.236B Authority must appoint a person to receive and analyse spot price risk disclosure statements
- 13.236C Authority may approve consolidated spot price risk disclosure statements
- 13.236D Authority must publish base case, stress test, and method for calculating target cover ratio
- 13.236E Content of spot price risk disclosure statements
- 13.236F Certification of spot price risk disclosure statement
- 13.236G Authority may require disclosing participant to submit new spot price risk disclosure statement
- 13.236H Authority may require independent audit of spot price risk disclosure statement or certification
- 13.236I Payment of auditor's costs
 - Subpart 5B— Hedge market arrangements
- 13.236J Contents of this subpart
- 13.236K Application of subpart
- 13.236L Requirement to quote
- 13.236M *[Revoked]*
- 13.236N Exemptions from requirement to quote
 - Subpart 6—Financial transmission rights
- 13.237 Contents of this subpart
 - FTR allocation plan*
- 13.238 Preparation and publication of FTR allocation plan
- 13.239 FTR manager gives draft FTR allocation plan to Authority
- 13.240 Authority approves FTR allocation plan
- 13.241 Variations to FTR allocation plan
 - Allocation, creation and reconfiguration of FTRs*
- 13.242 FTR manager must allocate and create FTRs
- 13.242A FTR manager to adjust offered FTR and FTR acquisition cost after FTR reconfiguration auction

- 13.243 Participation in FTR auction
13.244 Acceptance of bids and offers in FTR auction
Auction revenue and FTR receipts and payments
- 13.245 Clearing manager must collect and allocate auction revenue
13.246 Clearing manager must deal with FTR receipts and payments
FTR register
- 13.247 FTR manager must operate FTR register
Assignment of FTRs
- 13.248 Assignment of FTRs
13.249 Liability for FTR payments when FTR assigned and price disclosed
13.250 Liability for FTR payments when FTR assigned and price not disclosed
Provision of information to the FTR manager and clearing manager
- 13.251 Information to be provided to FTR manager
13.252 Information to be provided to clearing manager
13.253 *[Revoked]*
13.254 Publication of results of FTR auctions
Suspension of FTR allocation
- 13.255 Authority may direct FTR manager to suspend allocation of FTRs
Provision of internal transfer pricing information by generator retailers
- 13.256 Generator retailers must provide ITP information to the Authority
13.257 Disclosure of change of methodology
13.258 Publication of ITP information by the Authority
Provision of retail gross margin reports by retailers
- 13.259 Provision of retail gross margin report by retailers
13.260 Publication of information contained in retail gross margin reports by the Authority
Authority may require review of ITP information and retail gross margin reports
- 13.261 Authority may require review of ITP information and retail gross margin reports by independent person
13.262 Nomination of independent person to undertake review
13.263 Factors relevant to a direction under clause 13.262
13.264 Carrying out of review by independent person
13.265 Payment of review costs
13.266 Requirement to provide complete and accurate information
- Subpart 7—Restrictions on materially large contracts
- 13.267 Contents of this subpart
13.268 Definition of materially large contract

- 13.269 Restriction on materially large contracts
- 13.270 Calculation of net value of the materially large contract to the generator
- 13.271 Disclosure of materially large contracts
- 13.272 Application to the Authority for clearance of a materially large contract
- 13.273 Authority may provide clearance for a materially large contract
- 13.274 Reconsideration by Authority of clearance decision
- 13.275 Right of appeal against clearance decision
- 13.276 Disclosure of cleared materially large contract
- 13.277 Requirement to provide complete and accurate information
- 13.278 Authority must keep information confidential
- 13.279 Appointment of auditor
- 13.280 Carrying out of audit
- 13.281 Payment of costs relating to audits
- 13.282 Transitional arrangements

Schedule 13.1

Forms 1 to 9

Schedule 13.2

Model parameters

Schedule 13.3

The Modelling System

Inputs into the modelling system

Inputs used at each stage

The objective function

Schedule 13.3A

Calculation of interim prices and interim reserve prices in scarcity pricing situation

[Revoked]

Schedule 13.3AA

Managing an unsupplied demand situation in the dispatch schedule

Schedule 13.3B

Information for schedules prepared by system operator

Schedule 13.4

Approval as type A or type B industrial co-generating station

Schedule 13.5

Requirements for FTR allocation plan

Schedule 13.6

Assignment of FTR

Schedule 13.7

Methodology for Determining Conforming and Non-Conforming GXPs

Schedule 13.8

Approval of dispatch-capable load station

13.1 Contents of this Part

This Part provides for processes by which—

- (a) **purchasers and generators** submit and revise **bids and offers for electricity**, **grid owners** submit and revise information, **ancillary service agents** submit and revise **reserve offers**, the **system operator** forecasts **demand at conforming GXPs**, and the **system operator** collects information to enable schedules to be prepared; and
- (b) the **system operator** prepares and **publishes** information from the **price-responsive schedules, non-response schedules, and dispatch schedules**, and formulates and issues **dispatch instructions and dispatch notifications**; and
- (c) the **clearing manager** holds must-run dispatch **auctions**; and
- (d) the **clearing manager** produces **interim prices**; and
- (daa) **pricing errors** are claimed, investigated, and resolved; and
- (dab) **interim prices** become **final prices**; and
- (da) the **Authority** determines whether each **GXP** is either a **conforming GXP** or a **non-conforming GXP**; and
- (db) the **clearing manager** calculates **constrained off amounts and constrained on amounts**; and
- (e) **generators** may apply to the **Authority** to have 1 or more **generating units** approved as—
 - (i) a **type A industrial co-generating station**; or
 - (ii) a **type B industrial co-generating station**; and
- (f) information about **risk management contracts** is disclosed; and
- (fa) **disclosing participants** prepare and submit **spot price risk disclosure statements**; and
- (g) the **FTR manager** prepares and **publishes** the **FTR allocation plan**, creates and allocates **FTRs**, and operates the **FTR register**; and
- (h) the **clearing manager** collects and allocates **FTR auction** revenue; and
- (i) information about **FTRs** is provided; and
- (j) a device or a group of devices may be approved to be a **dispatch-capable load station**; and
- (k) **purchasers** are approved as **dispatch notification purchasers**; and
- (l) **generators** are approved as **dispatch notification generators**.

Compare: Electricity Governance Rules 2003 rule 1 section I part G

Clause 13.1(a) and (b): substituted, on 28 June 2012, by clause 5(a) of the Electricity Industry Participation (Demand-side Bidding and Forecasting) Code Amendment 2011.

Clause 13.1(b): amended, on 1 November 2022, by clause 11(1) of the Electricity Industry Participation Code Amendment (Real Time Pricing) 2022.

Clause 13.1(d): amended, on 1 November 2022, by clause 11(2) of the Electricity Industry Participation Code Amendment (Real Time Pricing) 2022.

Clause 13.1(daa) and (dab): inserted, on 1 November 2022, by clause 11(3) of the Electricity Industry Participation Code Amendment (Real Time Pricing) 2022.

Clause 13.1(da): inserted, on 28 June 2012, by clause 5(b) of the Electricity Industry Participation (Demand-side Bidding and Forecasting) Code Amendment 2011.

Clause 13.1(db) and (fa): inserted, on 15 May 2014, by clause 37 of the Electricity Industry Participation (Minor Code Amendments) Code Amendment 2014.

Clause 13.1(e): substituted, on 27 May 2015, by clause 5 of the Electricity Industry Participation Code Amendment (Industrial Co-generation Dispatch Arrangements) 2015.

Clause 13.1(g)-(i): inserted, on 1 October 2011, by clause 7 of the Electricity Industry Participation (Financial Transmission Rights) Code Amendment 2011.

Clause 13.1(j): inserted, on 15 May 2014, by clause 6 of the Electricity Industry Participation (Modified Dispatchable Demand) Code Amendment 2013.

Clause 13.1(j): amended, on 1 November 2022, by clause 11(4) of the Electricity Industry Participation Code Amendment (Real Time Pricing) 2022.

Clause 13.1(k) and (l): inserted, on 1 November 2022, by clause 11(5) of the Electricity Industry Participation Code Amendment (Real Time Pricing) 2022.

13.2 Misleading, deceptive, or incorrect information

- (1) A **participant** must not disclose to any person any information under this Part that, at the time the information was disclosed, was misleading or deceptive or likely to mislead or deceive when taken in the context of activities under this Part.
- (1A) In assessing whether information, at the time of disclosure, is misleading or deceptive or is likely to mislead or deceive, a **participant** must act reasonably and prudently.
- (2) If a **participant** discovers that information previously disclosed by it to a person under this Part was misleading, deceptive or incorrect, the **participant** must, as soon as reasonably practicable,—
 - (a) disclose further information so that the person is not misled or deceived by the information; or
 - (b) disclose corrected information to the person.

Clause 13.2: substituted, on 1 October 2013, by clause 5 of the Electricity Industry Participation (Disclosure Obligations) Code Amendment 2013.

Clause 13.2(2): amended, on 21 June 2018, by clause 4 of the Electricity Industry Participation Code Amendment (Disclosure Obligations) 2018.

13.2A Participant must make disclosure information readily available

- (1) Each **participant** must make all **disclosure information** in relation to the **participant** readily available to the public, free of charge, as soon as reasonably practicable after the **participant** becomes aware of the information.
- (2) Despite subclause (1), a **participant** is not required to make **disclosure information** readily available to the public if—
 - (a) the **disclosure information** is **excluded Code information**; or
 - (b) *[Revoked]*
 - (ba) a reasonable person would not expect the **disclosure information** to be made readily available; or
 - (c) the **participant** is bound by a legal obligation to keep the **disclosure information** confidential; or

- (d) doing so will be a breach of law; or
 - (e) the **disclosure information** is already readily available to the public; or
 - (f) the **disclosure information** concerns an incomplete proposal or negotiation; or
 - (g) the **disclosure information** comprises matters of supposition or is insufficiently definite to warrant being made readily available to the public; or
 - (h) the **participant** claims legal professional privilege or privilege against self-incrimination in respect of the **disclosure information**; or
 - (i) the **disclosure information** is a trade secret.
- (3) A **participant** that relies on subclause (2) must, as soon as reasonably practicable, make the **disclosure information** readily available to the public, free of charge, if subclause (2) ceases to apply to the **disclosure information**.
- (4) If information ceases to be **disclosure information**, a **participant** is no longer required to make the information readily available to the public.
- (5) A **participant** that does not make information readily available to the public under this clause must, if required to do so by the **Authority**,—
- (a) satisfy the **Authority** that subclause (2) applies to the **disclosure information**, if the **participant** relies on subclause (2); or
 - (b) satisfy the **Authority** that the information is not **disclosure information**.
- (6) A **participant** must not enter into a confidentiality agreement with another person for the purpose of avoiding making **disclosure information** readily available to the public under this clause.

Clause 13.2A: inserted, on 1 October 2013, by clause 6 of the Electricity Industry Participation (Disclosure Obligations) Code Amendment 2013.

Clause 13.2A(2)(b): revoked, on 21 June 2018, by clause 5(1) of the Electricity Industry Participation Code Amendment (Disclosure Obligations) 2018.

Clause 13.2A(2)(ba): inserted, on 21 June 2018, by clause 5(2) of the Electricity Industry Participation Code Amendment (Disclosure Obligations) 2018.

13.2B Submission of quarterly disclosure reports by major participants

- (1) Each **major participant** must submit **quarterly disclosure reports** to the **Authority**.
- (2) Each **quarterly disclosure report** must contain the following information relating to the **major participant's** activities in each quarter beginning 1 January, 1 April, 1 July and 1 October:
- (a) whether or not it held or was aware of any **disclosure information** to which clause 13.2A(1) applies during the quarter:
 - (b) subject to clause 13.2C(2), the means by which it made any such **disclosure information** readily available to the public during the quarter:
 - (c) if during the quarter it decided not to make any such **disclosure information** readily available to the public:
 - (i) the number of times it decided to do so; and
 - (ii) subject to subclause (3), the **disclosure information** or a description of the **disclosure information**; and
 - (iii) the date on which it decided to not make the **disclosure information** readily available to the public; and
 - (iv) the grounds it relied on under clause 13.2A(2) to not make the **disclosure information** readily available to the public; and

- (v) if it subsequently decided to make the **disclosure information** readily available to the public during the quarter in accordance with clause 13.2A(3), as the ground in clause 13.2A(2) no longer applies, the date on which it decided to make the **disclosure information** readily available to the public;
 - (d) if it decided during a previous quarter not to make any **disclosure information** readily available to the public, and continues to not make that information readily available to the public in the quarter to which the **quarterly disclosure report** relates (“the current quarter”):
 - (i) subject to subclause (3), either:
 - (A) the **disclosure information** or a description of the **disclosure information**; or
 - (B) a reference to the earlier **quarterly disclosure report** containing the **disclosure information** or the description of the **disclosure information** sufficient to enable the **Authority** to identify the **disclosure information** or the description of the **disclosure information**; and
 - (ii) the grounds it is relying on under clause 13.2A(2) to not make the **disclosure information** readily available to the public in the current quarter;
 - (e) if it decided during a previous quarter not to make any **disclosure information** readily available to the public but subsequently decided, upon the ground in clause 13.2A(2) no longer applying, to make that **disclosure information** readily available to the public in the current quarter in accordance with clause 13.2A(3):
 - (i) subject to clause 13.2C(2), the means by which it made any such **disclosure information** readily available to the public during the current quarter; and
 - (ii) the **disclosure information**; and
 - (iii) the date it made the **disclosure information** readily available to the public; and
 - (iv) the previous quarter or quarters it decided to not make the **disclosure information** readily available to the public;
 - (f) whether or not it complied with clause 13.2A during the quarter;
 - (g) if it did not comply with clause 13.2A at any time during the quarter, the details of that non-compliance.
- (3) If the **major participant** has not made the **disclosure information** readily available to the public on one of the grounds set out in clause 13.2A(2)(h), the **major participant** does not need to provide the **disclosure information** or a description of it under subclause (2)(c)(ii) or (2)(d)(i) to the **Authority** if doing so would undermine the ground for not making the **disclosure information** readily available to the public.
- (4) For the purposes of each **quarterly disclosure report**, each **major participant**—
- (a) does not breach subclause (2) if it fails to include in a **quarterly disclosure report** information which it did not believe was **disclosure information** and there was a reasonable basis for that belief; but

- (b) must treat any information that came within the definition of **disclosure information** to which clause 13.2A(1) applies at any time during the quarter as **disclosure information**, even if it ceased to be **disclosure information** during the quarter.
 - (5) Subject to clause 13.2E(3), the requirement to provide information under subclause (1)—
 - (a) applies despite any legal obligation to keep the **disclosure information** confidential and shall not be deemed a breach of any such obligation; and
 - (b) does not put the **major participant** in breach of any law.
- Clause 13.2B: inserted, on 1 April 2021, by clause 5 of the Electricity Industry Participation Code Amendment (Reporting on Wholesale Market Information Disclosure) 2020.

13.2C Specific requirements under clause 13.2B

- (1) Each **major participant** who provides a description of the **disclosure information** for the purposes of clause 13.2B(2)(c)(ii) or 13.2B(2)(d)(i) must provide a sufficient description to reasonably enable the **Authority** to identify whether it is likely that the **major participant** held or continues to hold—
 - (a) information that is **disclosure information** for the purposes of clause 13.2A(1); and
 - (b) reasonable grounds to not make the **disclosure information** readily available to the public in accordance with clause 13.2A(2).
- (2) Each **major participant** must provide sufficient information to the **Authority** under clauses 13.2B(2)(b) and 13.2B(2)(e)(i) to enable the **Authority** to find the **disclosure information** made readily available to the public during the quarter, including any website addresses.

Clause 13.2C: inserted, on 1 April 2021, by clause 5 of the Electricity Industry Participation Code Amendment (Reporting on Wholesale Market Information Disclosure) 2020.

13.2D Timing and form of quarterly disclosure reports under clause 13.2B

- (1) Each **major participant** must submit the **quarterly disclosure report** to the **Authority** together with the following:
 - (a) a certification that a person to whom subclause (3)(a) applies considers, on reasonable grounds and to the best of that person's belief, that the **quarterly disclosure report** is complete and is a true and correct record of the matters stated in the **quarterly disclosure report**; and
 - (b) a report as to whether or not the **major participant** has a written policy, procedure and/or process for identifying and determining whether—
 - (i) any information held by the **major participant** is **disclosure information** to which clause 13.2A(1) applies; and
 - (ii) there are grounds under clause 13.2A(2) for not making that information readily available to the public.
- (2) Each **major participant** must submit the **quarterly disclosure report**, the certification required by subclause (1)(a) and the report required by subclause (1)(b) to the **Authority**—
 - (a) by the end of the month following the expiry of the quarter to which the **quarterly disclosure report** relates; and
 - (b) in the form specified by the **Authority**.

- (3) Each **major participant** must ensure that the **quarterly disclosure report**, the certification required by subclause (1)(a) and the report required by subclause (1)(b) are either—
- (a) signed and dated by a director, or the chief executive officer, or the chief financial officer, or a person holding a position equivalent to one of those positions, of the **major participant**; or
 - (b) otherwise marked in a way specified by the **Authority** or linked in a way specified by the **Authority** to evidence such a person’s approval of the **quarterly disclosure report** and—
 - (i) the certification required by subclause (1)(a); and
 - (ii) the report required by subclause (1)(b).

Clause 13.2D: inserted, on 1 April 2021, by clause 5 of the Electricity Industry Participation Code Amendment (Reporting on Wholesale Market Information Disclosure) 2020.

13.2E Publication of information in quarterly disclosure reports by the Authority

- (1) The **Authority** may publish any information submitted to it in a **quarterly disclosure report**, the certification required by clause 13.2D(1)(a) and the report required by clause 13.2D(1)(b), provided any such publication does not involve the publication of—
- (a) any **disclosure information** that the **major participant** did not make readily available to the public by reason of clauses 13.2A(2)(ba) to 13.2A(2)(d), 13.2A(2)(f) to 13.2A(2)(g), or 13.2A(2)(i); or
 - (b) information from which the nature of any **disclosure information** that the **major participant** did not make readily available to the public by reason of clauses 13.2A(2)(ba) to 13.2A(2)(d), or 13.2A(2)(f) to 13.2A(2)(i) can reasonably be identified by another **participant** or member of the public; or
 - (c) the grounds relied on under clauses 13.2A(2)(ba) to 13.2A(2)(d), or 13.2A(2)(f) to 13.2A(2)(i) by the **major participant** to not make **disclosure information** readily available to the public, where the disclosure of those grounds would enable another **participant** or a member of the public to reasonably identify the **disclosure information**.
- (2) The limitations in subclause (1)(a) to (1)(c) do not apply if the grounds under clauses 13.2A(2)(ba) to 13.2A(2)(d), or 13.2A(2)(f) to 13.2A(2)(i) no longer apply to the **disclosure information**.
- (3) If a **major participant** identifies to the **Authority** that the **major participant** is bound by a legal obligation to keep confidential any **disclosure information** provided to the **Authority** in a **quarterly disclosure report** or that disclosure of the **disclosure information** by the **major participant** would be a breach of law, the **Authority** is required to keep that **disclosure information** confidential, except that this subclause does not prevent the use of the **disclosure information** for the purposes of clause 13.2F(1)(b).
- (4) The **Authority** is not required to keep **disclosure information** to which subclause (3) applies confidential if it does not consider on reasonable grounds that the **major participant** is bound by a legal obligation to keep the **disclosure information** confidential or that disclosure of the **disclosure information** by the **major participant** would be a breach of law.

Clause 13.2E: inserted, on 1 April 2021, by clause 5 of the Electricity Industry Participation Code Amendment (Reporting on Wholesale Market Information Disclosure) 2020.

13.2F Use of information in quarterly disclosure reports by the Authority

- (1) The **Authority** may use the **disclosure information** set out in a **quarterly disclosure report**—
 - (a) as provided in clause 13.2E(1); or
 - (b) for the purposes set out in section 16(1)(b), (c), (d), (f), and (g) of the **Act**.
- (2) The **Authority** may not use any information subject to legal professional privilege for the purposes in subclause (1)(b) above other than for the purpose of monitoring and enforcing compliance with clause 13.2A.
- (3) The **Authority** must comply with section 48(2) and 48(3) of the **Act** in respect of information that is subject to privilege against self-incrimination.
Clause 13.2F: inserted, on 1 April 2021, by clause 5 of the Electricity Industry Participation Code Amendment (Reporting on Wholesale Market Information Disclosure) 2020.

13.2G Authority may require review of disclosure requirements or certification by independent person

- (1) The **Authority** may, in its discretion, require a review by an independent person of whether a **major participant** may not have complied with any or all of clauses 13.2B to 13.2D.
Clause 13.2G: inserted, on 1 April 2021, by clause 5 of the Electricity Industry Participation Code Amendment (Reporting on Wholesale Market Information Disclosure) 2020.

13.2H Nomination of independent person to undertake review

- (1) If the **Authority** requires a review under clause 13.2G—
 - (a) the **Authority** must require the **major participant** to nominate an appropriate independent person to undertake the review; and
 - (b) the **major participant** must provide that nomination within a reasonable timeframe.
- (2) The **Authority** may direct the **major participant** to appoint the person nominated under subclause (1) or to nominate another person for approval.
- (3) If the **major participant** fails to nominate an appropriate person under subclause (1) within 5 **business days**, the **Authority** may direct the **major participant** to appoint a person of the **Authority's** choice.
- (4) The **major participant** must appoint a person to undertake the review in accordance with a direction made under subclause (2) or subclause (3).
Clause 13.2H: inserted, on 1 April 2021, by clause 5 of the Electricity Industry Participation Code Amendment (Reporting on Wholesale Market Information Disclosure) 2020.

13.2I Factors relevant to a direction under clause 13.2H

- (1) In making the direction required by clause 13.2H(2) or clause 13.2H(3), the **Authority** may have regard to any factors it considers relevant in the circumstances, including the following:
 - (a) the degree of independence between the **major participant** and the person nominated under clause 13.2H(1);
 - (b) the expected quality of the review; and
 - (c) the expected costs of the review.
- (2) For the purposes of subclause (1)(a), the **Authority** may have regard to the special definition of independent under clause 1.4 but is not bound by that definition.
Clause 13.2I: inserted, on 1 April 2021, by clause 5 of the Electricity Industry Participation Code Amendment (Reporting on Wholesale Market Information Disclosure) 2020.

13.2J Carrying out of review by independent person

- (1) A **major participant** subject to a review under clause 13.2G must, on request from the person undertaking the review, provide that person with such information as the person reasonably requires in order to carry out the review.
- (2) The **major participant** must provide the information no later than 10 **business days** after receiving a request from the person for the information.
- (3) The **major participant** must ensure that the person undertaking the review—
 - (a) produces a report on whether, in the opinion of that person, the **major participant** may not have complied with clauses 13.2B to 13.2D (as specified by the **Authority**) under clause 13.2G; and
 - (b) submits the report to the **Authority** within the timeframe specified by the **Authority**.
- (4) The report produced under subclause (3)(a) must include any other information that the **Authority** may reasonably require.
- (5) Before the report is submitted to the **Authority**, any identified failure of the **major participant** to comply with clauses 13.2B to 13.2D must be referred back to the **major participant** for comment.
- (6) The comments of the **major participant** must be included in the report.
- (7) The **major participant** may require that the person does not provide the **Authority** with a copy of any information that the **major participant** has provided to the person in accordance with subclause (2).

Clause 13.2J: inserted, on 1 April 2021, by clause 5 of the Electricity Industry Participation Code Amendment (Reporting on Wholesale Market Information Disclosure) 2020.

13.2K Payment of review costs

- (1) If a report received under clause 13.2J(3)(a) establishes, to the **Authority's** reasonable satisfaction, that the **major participant** may not have complied with clauses 13.2B to 13.2D (whether or not the **Authority** appoints an investigator to investigate the alleged breach), the **major participant** must pay the costs of the person who undertook the review.
- (2) Despite subclause (1), if a report establishes, to the **Authority's** reasonable satisfaction that any non-compliance of the **major participant** is minor, the **Authority** may, in its discretion, determine the proportion of the person's costs that the **major participant** must pay, and the **major participant** must pay those costs.
- (3) If a report establishes to the **Authority's** reasonable satisfaction that the **major participant** has complied with clauses 13.2B to 13.2D, the **Authority** must pay the person's costs.

Clause 13.2K: inserted, on 1 April 2021, by clause 5 of the Electricity Industry Participation Code Amendment (Reporting on Wholesale Market Information Disclosure) 2020.

13.2L Requirement to provide complete and accurate information

- (1) In addition to the requirements of clause 13.2, the **major participant** must take all practicable steps to ensure that the information that the **major participant** is required to provide to any person under clauses 13.2B to 13.2D is complete and correct.
- (2) If a **major participant** becomes aware that any information the **major participant** provided under clauses 13.2B to 13.2D does not comply with subclause (1) or clause 13.2, even if the **major participant** has taken all practicable steps to ensure that the information complies, the **major participant** must, as soon as practicable, provide such further information as is necessary to ensure that the information provided complies with clauses 13.2B to 13.2D and clause 13.2.

Clause 13.2L: inserted, on 1 April 2021, by clause 5 of the Electricity Industry Participation Code Amendment (Reporting on Wholesale Market Information Disclosure) 2020.

13.3 Approval process for industrial co-generating stations

A **generator** may apply to the **Authority** to have 1 or more **generating units** approved as—

- (a) a **type A industrial co-generating station** under clause 8(1)(a)(i) of Schedule 13.4; or
- (b) a **type B industrial co-generating station** under clause 8(1)(a)(ii) of Schedule 13.4.

Compare: Electricity Governance Rules 2003 rule 3 section I part G

Clause 13.3: substituted, on 27 May 2015, by clause 6 of the Electricity Industry Participation Code Amendment (Industrial Co-generation Dispatch Arrangements) 2015.

13.3A Approval process for dispatch-capable load stations

- (1) A **purchaser** at a **GXP** may apply to the **system operator** for approval for a device or a group of devices at the **GXP** to be a **dispatch-capable load station** under Schedule 13.8.
- (1A) In addition to subclause (1), a **purchaser** who intends to operate devices or a group of devices as a **dispatch notification purchaser** may apply to the **system operator** for approval for devices or a group of devices located at more than one **GXP** to be a **dispatch-capable load station** under Schedule 13.8.
- (2) The **system operator** must consider an application under subclause (1) or (1A) in accordance with Schedule 13.8.
- (3) If the **system operator** approves a device or a group of devices as a **dispatch-capable load station** following an application by a **purchaser** under subclause (1) or (1A)—
 - (a) the approval is valid until the date the approval is revoked under clause 10 of Schedule 13.8; but
 - (b) a device or group of devices in respect of which the approval is granted is not a **dispatch-capable load station** while its approval is suspended under clause 10 of Schedule 13.8.
- (4) The **system operator** must suspend or revoke an approval for devices or a group of devices located at more than one **GXP** to be a **dispatch-capable load station** in accordance with clause 10 of Schedule 13.8 if the **purchaser** is not, will not in the future or states that it no longer intends to operate as, a **dispatch notification purchaser** in respect of the relevant **dispatch-capable load station**.
- (5) Where the **system operator** suspends such an approval under subclause (4), the **system operator** must continue such suspension until—
 - (a) the **purchaser** re-commences operating as a **dispatch notification purchaser** in respect of the relevant **dispatch capable load station**; or
 - (b) the **system operator** revokes the approval for devices or a group of devices located at more than one **GXP** to be a **dispatch-capable load station** in accordance with clause 10 of Schedule 13.8.

Clause 13.3A: inserted, on 15 May 2014, by clause 7 of the Electricity Industry Participation (Modified Dispatchable Demand) Code Amendment 2013.

Clause 13.3A(1A): inserted, on 1 March 2024, by clause 5(1) of the Electricity Industry Participation Code Amendment (Dispatch Notification Enhancement and Clarifications) 2024.

Clause 13.3A(2): amended, on 1 March 2024, by clause 5(2) of the Electricity Industry Participation Code Amendment (Dispatch Notification Enhancement and Clarifications) 2024.

Clause 13.3A(3): amended, on 1 March 2024, by clause 5(3) of the Electricity Industry Participation Code Amendment (Dispatch Notification Enhancement and Clarifications) 2024.

Clause 13.3A(4) and (5): inserted, on 1 March 2024, by clause 5(4) of the Electricity Industry Participation Code Amendment (Dispatch Notification Enhancement and Clarifications) 2024.

13.3B Purchasers to advise system operator of changes to dispatch-capable load station

- (1) A **purchaser** to which a **dispatch-capable load station** approval is granted must advise the **system operator** of any change to the factors the **system operator** considered in granting approval, including an intended change of the **dispatchable load purchaser**.
- (2) A **purchaser** must advise the **system operator** of the change no later than 10 **business days** before the change takes effect.
- (3) The **system operator** must consider the change advised and decide whether—
 - (a) to amend the approval under clause 10 of Schedule 13.8; or
 - (b) to revoke the approval under clause 10 of Schedule 13.8; or
 - (c) to suspend the approval under clause 10 of Schedule 13.8.

Clause 13.3B Heading: replaced, on 5 October 2017, by clause 334 of the Electricity Industry Participation Code Amendment (Code Review Programme) 2017.

Clause 13.3B: inserted, on 15 May 2014, by clause 7 of the Electricity Industry Participation (Modified Dispatchable Demand) Code Amendment 2013.

13.3C System operator to publish dispatch-capable load station approval process guidelines

- (1) The **system operator** must **publish** guidelines for the purpose of assisting **purchasers** to obtain approval under clause 13.3A.
- (2) Before **publishing** the guidelines under subclause (1), the **system operator** must consult with **participants** on the guidelines.
- (3) To avoid doubt, consultation undertaken before the commencement of this clause is to be treated as the consultation required for the purpose of subclause (2).

Clause 13.3C: inserted, on 15 May 2014, by clause 7 of the Electricity Industry Participation (Modified Dispatchable Demand) Code Amendment 2013.

13.3D Access to WITS

- (1) A **participant** that requires access to **WITS** must apply to the **Authority** to have access to **WITS**.
- (2) The **Authority** must specify and **publish** the terms and conditions that apply to **participants** that are granted access to **WITS**.
- (3) For the avoidance of doubt, the terms and conditions specified and **published** under subclause (2) apply to a **participant** that has access to **WITS** as at 18 April 2019.
- (4) If the **Authority** grants a **participant's** application—
 - (a) the **WITS manager** must provide the **participant** with access to **WITS** in accordance with the terms and conditions specified and **published** by the **Authority** under subclause (2):
 - (b) the **participant** must comply with the terms and conditions specified and **published** by the **Authority** under subclause (2), including any amendments under subclause (5):
 - (c) the **Authority** may restrict or suspend a **participant's** access to **WITS** if the **participant** does not comply with those terms and conditions, even though such a restriction or suspension may affect a **participant's** ability to meet its obligations under this Code.

- (5) The **Authority** may, from time to time, specify and **publish** amendments to the terms and conditions under which the **Authority** grants access to **WITS**. Such amendments will apply—
 - (a) to those **participants** the **Authority** has already granted access to **WITS**; and
 - (b) to future applications for access to **WITS**.
- (6) The **Authority** must consult with the **participants** referred to in subclause (5)(a) on any proposed amendments to the terms and conditions specified and **published** by the **Authority** under subclause (2).
- (7) The terms and conditions specified and **published** by the **Authority** under subclause (2), including any amendments specified under subclause (5), replace any agreements to access **WITS**, which the **participant** and the **WITS manager** had agreed prior to 18 April 2019.

Clause 13.3D: inserted, on 18 April 2019, by clause 5 of the Electricity Industry Participation Code Amendment (Terms and Conditions for Access to Registry and WITS) 2019.

Clause 13.3D(6): amended, on 1 March 2024, by clause 68 of the Electricity Industry Participation Code Amendment (Code Review Programme) 2024.

13.3E Approval process for dispatch notification purchasers

- (1) A **purchaser** may apply to become a **dispatch notification purchaser** by applying to the **system operator** for approval of the relevant device or group of devices as a **dispatch-capable load station** under Schedule 13.8.
- (2) If the **system operator** receives an application under subclause (1), the **system operator** must consider the application in accordance with Schedule 13.8.
- (2A) The **system operator** may only approve an application if the **Authority** has confirmed to the **system operator** that the applicant will be able to comply with clause 13.82B.
- (3) If the **system operator** approves a **purchaser's** application to become a **dispatch notification purchaser**,—
 - (a) the **purchaser** is a **dispatch notification purchaser** in relation to the **dispatch-capable load station** to which the application relates; and
 - (b) the approval is valid until the date on which the approval is revoked under clause 10 of Schedule 13.8; but
 - (c) the **purchaser** in respect of which approval is granted is not a **dispatch notification purchaser** while approval for the **relevant dispatch-capable load station** is suspended under clause 10 of Schedule 13.8.
- (4) The **system operator** may suspend or revoke an approval for a **dispatch notification purchaser** in accordance with clause 10 of Schedule 13.8 if the **purchaser** has repeatedly submitted revised **bids** under clause 13.19C(1) such that it is no longer appropriate for the **purchaser** to remain a **dispatch notification purchaser**, taking into account any criteria set out in the **policy statement**.

Clause 13.3E: inserted, on 1 November 2022, by clause 12 of the Electricity Industry Participation Code Amendment (Real Time Pricing) 2022.

Clause 13.3E(2A): inserted, on 1 March 2024, by clause 6 of the Electricity Industry Participation Code Amendment (Dispatch Notification Enhancement and Clarifications) 2024.

13.3F Approval process for dispatch notification generators

- (1) A **generator** may, by notice in writing to the **system operator**, apply to become a **dispatch notification generator** in respect of a **generating station** that exports less than 30 MW to the **grid** or a **local network**.

- (2) The notice must specify the **generating station** in respect of which the **generator** wishes to be a **dispatch notification generator**.
- (3) The **system operator** must approve an application received under subclause (1) if the application—
 - (a) relates to a **generating station** that exports less than 30 **MW** to the **grid** or a **local network**; and
 - (b) meets any criteria for approval set out in the **policy statement**.
- (3A) Notwithstanding subclause (3), the **system operator** may only approve an application received under subclause (1) if the **Authority** has confirmed to the **system operator** that the applicant will be able to comply with clause 13.82B.
- (4) The **system operator** may revoke an approval for a **dispatch notification generator** if—
 - (a) the **generator** no longer meets the approval requirements; or
 - (b) the **generator** has repeatedly submitted revised **offers** under clause 13.19C(2) such that it is no longer appropriate for the **generator** to remain a **dispatch notification generator**, taking into account any criteria set out in the **policy statement**.

Clause 13.3F: inserted, on 1 November 2022, by clause 12 of the Electricity Industry Participation Code Amendment (Real Time Pricing) 2022.

Clause 13.3F(3A): inserted, on 1 March 2024, by clause 7 of the Electricity Industry Participation Code Amendment (Dispatch Notification Enhancement and Clarifications) 2024.

Subpart 1—Bids and offers

13.4 Contents of this subpart

This subpart provides for processes to facilitate **trading** by which—

- (a) **bids** and **offers** for **electricity** are submitted and revised by **generators** and **purchasers**; and
- (b) information from the **grid owners** is submitted and revised; and
- (c) **reserve offers** are submitted and revised by **ancillary service agents**; and
- (d) the **system operator** collects the information referred to in this subpart; and
- (e) information about **bids** and **offers** is to be made available.

Compare: Electricity Governance Rules 2003 rule 1 section II part G

13.5 Bids and offers must be lawful

A **purchaser**, **generator** or **ancillary service agent** must not make or maintain a **bid**, **offer** or **reserve offer** if the **purchaser** or **generator** or **ancillary service agent** knows or ought reasonably to know that acting in accordance with the **bid**, **offer** or **reserve offer** would contravene any law.

Compare: Electricity Governance Rules 2003 rule 2 section II part G

Clause 13.5: amended, on 28 June 2012, by clause 6 of the Electricity Industry Participation (Demand-side Bidding and Forecasting) Code Amendment 2011.

13.5A Conduct in relation to generators' offers and ancillary service agents' reserve offers

- (1) In the spot market –

- (a) it is expected that **offers** and **reserve offers** will generally be subject to competitive disciplines such that no party has significant market power;
 - (b) however, there may be locations where, or periods when, one or more generators, or ancillary service agents, as the case may be, has significant market power.
- (2) Accordingly –
- (a) where a **generator** submits or revises an **offer**, that offer must be consistent with the **offer** that the **generator**, acting rationally, would have made if no **generator** could exercise significant market power at the **point of connection** to the **grid** and in the **trading period** to which the **offer** relates;
 - (b) where an **ancillary service agent** submits or revises a **reserve offer**, that **offer** must be consistent with the **reserve offer** that the **ancillary service agent**, acting rationally, would have made if no **ancillary service agent** could exercise significant market power at the **point of connection** to the **grid** and in the **trading period** to which the **reserve offer** relates.
- (3) For the purposes of this clause –
- (a) market power becomes significant when its exercise would have a net adverse impact on economic efficiency, which includes productive, allocative and dynamic efficiency;
 - (b) “spot market” has the same meaning as **wholesale market** except that it excludes the hedge market for **electricity** (including the market for **FTRs**).

Clause 13.5A: inserted, on 17 July 2014, by clause 5 of the Electricity Industry Participation Code Amendment (Pivotal Supply) 2014.

Clause 13.5A(2): amended, on 29 June 2017, by clause 5 of the Electricity Industry Participation Code Amendment (Shortened Gate Closure and Revised Bid and Offer Provisions) 2017.

Clause 13.5A: replaced, on 30 June 2021, by clause 5 of the Electricity Industry Participation Code Amendment (Trading Conduct Provisions) 2021.

13.5B [Revoked]

Clause 13.5B: inserted, on 17 July 2014, by clause 5 of the Electricity Industry Participation Code Amendment (Pivotal Supply) 2014.

Clause 13.5B(1)(b) and (3)(b): amended, on 29 June 2017, by clause 6 of the Electricity Industry Participation Code Amendment (Shortened Gate Closure and Revised Bid and Offer Provisions) 2017.

Clause 13.5B: revoked, on 30 June 2021, by clause 6 of the Electricity Industry Participation Code Amendment (Trading Conduct Provisions) 2021.

Bids and offer preparation

13.6 Requirements for generators when submitting offers

- (1) Each **generator** with a **point of connection** to the **grid**, and each **embedded generator** required by the **system operator** to submit an **offer** under clause 8.25(5), must—
 - (a) submit to the **system operator** an **offer** for each **trading period** in the **schedule period**, under which the **generator** is prepared to sell **electricity** to the **clearing manager**; and
 - (b) ensure that the **system operator** receives an **offer** at least 71 **trading periods** before the beginning of the **trading period** to which the **offer** relates.

- (2) Despite subclause (1), a **generator** must give at least **5 business days'** notice in writing to the **system operator** and the **clearing manager** before the **generator** makes an **offer** for the 1st time in respect of the **generating plant** that is the subject of the **offer**.
- (3) The notice must state—
 - (a) the **point of connection** to the **grid** at which **electricity** generated by the **generator** is sold to the **clearing manager** under clause 14.3 or 14.4; and
 - (b) whether the **generating plant** is an **intermittent generating station**.
- (4) A **generator** must comply with any request from the **system operator** for information concerning **generating plant** that is the subject of a notice under subclause (2) if the **system operator** requires the information for the purposes of scheduling and **dispatch** in accordance with this Code.
- (5) Despite subclause (1), if a **generator** intends to permanently cease to submit **offers** to the **system operator** in respect of any **generating plant**, the **generator** must give at least **5 business days'** notice in writing to the **system operator** and the **clearing manager**.

Compare: Electricity Governance Rules 2003 rules 3.1 and 3.2 section II part G

Clause 13.6(1)-(3): substituted, on 28 June 2012, by clause 7 of the Electricity Industry Participation (Demand-side Bidding and Forecasting) Code Amendment 2011.

Clause 13.6(4): amended, on 23 February 2015, by clause 75 of the Electricity Industry Participation Code Amendment (Distributed Generation) 2014.

Clause 13.6: substituted, on 29 June 2017, by clause 7 of the Electricity Industry Participation Code Amendment (Shortened Gate Closure and Revised Bid and Offer Provisions) 2017.

Clause 13.6(2): amended, on 1 March 2024, by clause 69(1) of the Electricity Industry Participation Code Amendment (Code Review Programme) 2024.

Clause 13.6(5): amended, on 1 March 2024, by clause 69(2) of the Electricity Industry Participation Code Amendment (Code Review Programme) 2024.

13.7 Purchaser to submit bids for dispatch-capable load station

- (1) This clause applies to each **dispatchable load purchaser**.
- (2) Unless the **dispatchable load purchaser** relies on clause 13.8A, the **dispatchable load purchaser** must submit to the **system operator** for each of its **dispatch-capable load stations** for each **trading period** in the **schedule period**—
 - (a) a **nominated non-dispatch bid**; or
 - (b) a **nominated dispatch bid**.
- (3) A **nominated bid** submitted under subclause (2) must represent a reasonable estimate of the total quantity of **electricity** the **dispatchable load purchaser** will purchase—
 - (a) for the **dispatch-capable load station**; and
 - (b) for the **trading period**; and
 - (c) at the prices specified in the **nominated bid**.
- (4) A **dispatch notification purchaser** operating a **dispatch-capable load station** consisting of devices or a group of devices located at more than one **GXP** must submit **nominated bids** at—
 - (a) the primary **GXP** assigned by the **system operator** under clause 6(1A)(a) of Schedule 13.8; or
 - (b) if the **system operator** gives reasonable notice requiring the **dispatch notification purchaser** to submit **nominated bids** at an alternative **GXP** specified by the **system operator** under clause 6(1A)(b) of Schedule 13, that alternative **GXP** for the period specified in the notice.

Compare: Electricity Governance Rules 2003 rules 3.3 and 3.4 section II part G

Clause 13.7 Heading and (1): substituted, on 28 June 2012, by clause 8(1) of the Electricity Industry Participation (Demand-side Bidding and Forecasting) Code Amendment 2011.

Clause 13.7(1A) and (1B): inserted, on 28 June 2012, by clause 8(2) of the Electricity Industry Participation (Demand-side Bidding and Forecasting) Code Amendment 2011.

Clause 13.7(2): amended, on 28 June 2012, by clause 8(1) of the Electricity Industry Participation (Demand-side Bidding and Forecasting) Code Amendment 2011.

Clause 13.7: substituted, on 15 May 2014, by clause 8 of the Electricity Industry Participation (Modified Dispatchable Demand) Code Amendment 2013.

Clause 13.7(4): inserted, on 1 March 2024, by clause 8 of the Electricity Industry Participation Code Amendment (Dispatch Notification Enhancement and Clarifications) 2024.

13.7AA Purchaser to submit bids for non-dispatch-capable load

- (1) This clause applies to each **purchaser** that—
 - (a) purchases **non-dispatch-capable load**; and
 - (b) in relation to a **nominated bid**, does not rely on clause 13.8A.
- (2) The **purchaser**—
 - (a) must, if it purchases **non-dispatch-capable load** at a **non-conforming GXP**, submit to the **system operator** for each **trading period** in the **schedule period** a **nominated non-dispatch bid** that represents a reasonable estimate of the total **non-dispatch-capable load** that the **purchaser** will purchase—
 - (i) at the **GXP**; and
 - (ii) for the **trading period**; and
 - (iii) at the prices specified in the **nominated non-dispatch bid**; and
 - (b) may, if it purchases **non-dispatch-capable load** at a **conforming GXP**, submit to the **system operator** for a **trading period** a **difference bid** that represents a reasonable estimate of an increase or decrease in the **purchaser's** usual **non-dispatch-capable load** purchased—
 - (i) at the **GXP**; and
 - (ii) for the **trading period**; and
 - (iii) at the prices specified in the **difference bid**.

Clause 13.7AA: inserted, on 15 May 2014, by clause 8 of the Electricity Industry Participation (Modified Dispatchable Demand) Code Amendment 2013.

13.7AB Timeframe for submitting bids to system operator

- (1) Each **purchaser** that submits a **nominated bid** to the **system operator** must submit the **nominated bid** at least 71 **trading periods** before the beginning of the **trading period** to which the **nominated bid** applies.
- (2) Each **purchaser** that submits a **difference bid** to the **system operator** must submit the **difference bid** at least 4 **trading periods** before the beginning of the **trading period** to which the **difference bid** applies.

Clause 13.7AB: inserted, on 15 May 2014, by clause 8 of the Electricity Industry Participation (Modified Dispatchable Demand) Code Amendment 2013.

13.7AC Submitting bid for first time

- (1) Despite anything in this Code, a **purchaser** must give at least 5 **business days'** notice in writing to the **system operator** and the **clearing manager** before the **purchaser** submits a **bid** for the first time.
- (2) The **system operator** may request from a **purchaser** information—
 - (a) about the **purchaser**; and
 - (b) that the **system operator** requires for the purposes of scheduling and **dispatch** in accordance with this Code.

- (3) A **purchaser** must comply with a request made under subclause (2).

Clause 13.7AC: inserted, on 15 May 2014, by clause 8 of the Electricity Industry Participation (Modified Dispatchable Demand) Code Amendment 2013.

13.7AD Submitting bid for last time

Despite anything in this Code, if a **purchaser** intends to permanently cease to provide **bids** to the **system operator**, the **purchaser** must give at least 5 **business days'** notice in writing to the **system operator** and the **clearing manager**.

Clause 13.7AD: inserted, on 29 June 2017, by clause 8 of the Electricity Industry Participation Code Amendment (Shortened Gate Closure and Revised Bid and Offer Provisions) 2017.

Clause 13.7AD: amended, on 1 November 2022, by clause 13 of the Electricity Industry Participation Code Amendment (Real Time Pricing) 2022.

13.7A System operator to prepare forecast of non-dispatch-capable load at conforming GXPs

- (1) The **system operator** must prepare a forecast of **non-dispatch-capable load** for each **conforming GXP** for each **trading period** in a **schedule period**.
- (2) The **system operator** must—
- (a) disclose to the **Authority** a description of the processes and methodology it uses to prepare the forecast under subclause (1); and
 - (b) **publish** and keep **published**, either—
 - (i) the description it disclosed to the **Authority** under paragraph (a); or
 - (ii) a summary of the processes and methodology it uses to prepare the forecast under subclause (1).
- (3) Despite subclause (2), the **system operator** is required to disclose or **publish** information under subclause (2) only if the information—
- (a) is available to the **system operator**; and
 - (b) is not confidential or commercially sensitive.

Clause 13.7A: inserted, on 28 June 2012, by clause 9 of the Electricity Industry Participation (Demand-side Bidding and Forecasting) Code Amendment 2011.

Clause 13.7A Heading: amended, on 15 May 2014, by clause 9(a) of the Electricity Industry Participation (Modified Dispatchable Demand) Code Amendment 2013.

Clause 13.7A: amended, on 15 May 2014, by clause 9 of the Electricity Industry Participation (Modified Dispatchable Demand) Code Amendment 2013.

Clause 13.7A(2)(b): amended, on 5 October 2017, by clause 335(a) of the Electricity Industry Participation Code Amendment (Code Review Programme) 2017.

Clause 13.7A(3): amended, on 5 October 2017, by clause 335(b) of the Electricity Industry Participation Code Amendment (Code Review Programme) 2017.

13.7B Authority may request system operator to report on accuracy of forecasts of non-dispatch-capable load at conforming GXPs

- (1) The **Authority** may, from time to time, request the **system operator** to report to the **Authority** on the accuracy of the forecast that it prepares under clause 13.7A(1).
- (2) A request—
- (a) must specify the period that must be covered by the report; and
 - (b) must specify a reasonable date by which the **system operator** must provide the report; and
 - (c) must be made no more frequently than once per calendar month, unless the **system operator** agrees otherwise.

- (3) The **system operator** must comply with a request made under this clause.

Clause 13.7B: inserted, on 28 June 2012, by clause 9 of the Electricity Industry Participation (Demand-side Bidding and Forecasting) Code Amendment 2011.

Clause 13.7B Heading: amended, on 15 May 2014, by clause 10(a) of the Electricity Industry Participation (Modified Dispatchable Demand) Code Amendment 2013.

Clause 13.7B(1): amended, on 15 May 2014, by clause 10(b) of the Electricity Industry Participation (Modified Dispatchable Demand) Code Amendment 2013.

13.8 Deemed offers

- (1) This clause applies if, on any **trading day** ("the current **trading day**"), a **generator** has not submitted an **offer** for a **trading period** in the **trading day** following the next **trading day**.

- (2) A **generator** is deemed to have submitted, for that **trading period**, an **offer** that is the same as the **offer** the **generator** made for the corresponding **trading period** on the current **trading day**, and clause 13.9A applies accordingly.

- (3) A deemed **offer** under subclause (2) applies until the **generator** revises the **offer** in accordance with clauses 13.17 to 13.19.

Compare: Electricity Governance Rules 2003 rule 3.5 section II part G

Clause 13.8: substituted, on 28 June 2012, by clause 10 of the Electricity Industry Participation (Demand-side Bidding and Forecasting) Code Amendment 2011.

Clause 13.8(3): amended, on 15 May 2014, by clause 11 of the Electricity Industry Participation (Modified Dispatchable Demand) Code Amendment 2013.

Clause 13.8(2): amended, on 29 June 2017, by clause 9(1) of the Electricity Industry Participation Code Amendment (Shortened Gate Closure and Revised Bid and Offer Provisions) 2017.

Clause 13.8(3): amended, on 29 June 2017, by clause 9(2) of the Electricity Industry Participation Code Amendment (Shortened Gate Closure and Revised Bid and Offer Provisions) 2017

13.8A Deemed nominated bids

- (1) This clause applies if, on any **trading day** ("the current **trading day**"), a **purchaser** has not submitted a **nominated bid** for a **trading period** in the **trading day** following the next **trading day**.

- (2) A **purchaser** is deemed to have submitted, for that **trading period**, a **nominated bid** that is the same as the **nominated bid** the **purchaser** made for the corresponding **trading period** on the current **trading day**.

- (3) A deemed **nominated bid** under subclause (2) applies until the **purchaser** revises the **nominated bid** in accordance with clause 13.19A.

- (4) A **purchaser** must ensure that each of its deemed **nominated bids** under this clause,—
- (a) if it is a **nominated bid** for a **dispatch-capable load station**, represents a reasonable estimate of the total quantity of **electricity** that the **purchaser** will purchase for the **dispatch-capable load station** at the specified prices for the **trading period**; or
 - (b) if it is a **nominated bid** for **non-dispatch-capable load**, represents a reasonable estimate of the **non-dispatch-capable load** that the **purchaser** will purchase at the **GXP** at the specified prices for the **trading period**.

Clause 13.8A: inserted, on 28 June 2012, by clause 10 of the Electricity Industry Participation (Demand-side Bidding and Forecasting) Code Amendment 2011.

Clause 13.8A(2) & (3): amended, on 15 May 2014, by clause 12(a) & (b) of the Electricity Industry Participation (Modified Dispatchable Demand) Code Amendment 2013.

Clause 13.8A(4): inserted, on 15 May 2014, by clause 12(c) of the Electricity Industry Participation (Modified Dispatchable Demand) Code Amendment 2013.

Clause 13.8A(3): amended, on 29 June 2017, by clause 10 of the Electricity Industry Participation Code Amendment (Shortened Gate Closure and Revised Bid and Offer Provisions) 2017.

13.8B Deemed reserve offers

- (1) This clause applies if, on a **trading day** ("the current **trading day**"), an **ancillary service agent** who provides **instantaneous reserves** has not submitted a **reserve offer** for a **trading period** in the **trading day** following the next **trading day**.
- (2) An **ancillary service agent** is deemed to have submitted, for that **trading period**, a **reserve offer** that is the same as the **reserve offer** the **ancillary service agent** made for the corresponding **trading period** on the current **trading day**, and clause 13.38(2)(c) applies accordingly.
- (3) A deemed **reserve offer** under subclause (2) applies until the **ancillary service agent** revises the **reserve offer** in accordance with clauses 13.46 to 13.49.

Clause 13.8B: inserted, on 1 November 2012, by clause 4 of the Electricity Industry Participation (Part 13 Minor Amendments) Code Amendment 2012.

Clause 13.8B(3): amended, on 29 June 2017, by clause 11 of the Electricity Industry Participation Code Amendment (Shortened Gate Closure and Revised Bid and Offer Provisions) 2017.

13.9 Information that offers must contain

Each **offer** submitted by a **generator** must—

- (a) other than for **intermittent generators**, **type A co-generators**, and **type B co-generators**, contain all information required by Form 1 in Schedule 13.1; and
- (b) *[Revoked]*
- (c) if the **offer** is submitted by an **intermittent generator** for an **intermittent generating station**,—
 - (i) contain the information required by Form 2 in Schedule 13.1; and
 - (ii) *[Revoked]*
 - (iii) *[Revoked]*
- (d) if the **offer** is submitted by a **type A co-generator** for a **type A industrial co-generating station** or by a **type B co-generator** for a **type B industrial co-generating station**,—
 - (i) contain the information required by Form 3 in Schedule 13.1; and
 - (ii) have a maximum of 2 price bands for each **trading period**; and
 - (iii) specify a price of either \$0.00 (in accordance with clause 13.116) or \$0.01 for the price band.

Compare: Electricity Governance Rules 2003 rule 3.6 section II part G

Clause 13.9(a): amended, on 27 May 2015, by clause 7(1) of the Electricity Industry Participation Code Amendment (Industrial Co-generation Dispatch Arrangements) 2015.

Clause 13.9(b): revoked, on 29 June 2017, by clause 12 of the Electricity Industry Participation Code Amendment (Shortened Gate Closure and Revised Bid and Offer Provisions) 2017.

Clause 13.9(c)(ii) and (iii): revoked, at 12.00 pm on 19 September 2019, by clause 5 of the Electricity Industry Participation Code Amendment (Wind Offer Arrangements) 2019.

Clause 13.9(d): amended, on 27 May 2015, by clause 7(2) of the Electricity Industry Participation Code Amendment (Industrial Co-generation Dispatch Arrangements) 2015.

13.9A Offer not to exceed capability

- (1) The total **MW** specified in each **offer** submitted by a **generator** must, in relation to the **generating plant** that is the subject of the **offer**, not exceed the total **MW** that the **generator** expects to be capable of generating at the relevant **point of connection** to the **grid** for the relevant **trading period**.
- (2) Subclause (1) does not apply to an **intermittent generator**.

Clause 13.9A: inserted, on 29 June 2017, by clause 13 of the Electricity Industry Participation Code Amendment (Shortened Gate Closure and Revised Bid and Offer Provisions) 2017.

Clause 13.9A(2): inserted, at 12.00 pm on 19 September 2019, by clause 6 of the Electricity Industry Participation Code Amendment (Wind Offer Arrangements) 2019.

13.9B Offer requirements for intermittent generators

Each **offer** submitted by an **intermittent generator** must, in relation to the **generating plant** that is the subject of the **offer**,—

- (a) not exceed the **nameplate capacity** of the **generating plant**; and
- (b) include a **forecast of generation potential** for the **trading period** to which the **offer** relates.

Clause 13.9B: inserted, at 12.00 pm on 19 September 2019, by clause 7 of the Electricity Industry Participation Code Amendment (Wind Offer Arrangements) 2019.

13.10 Generators must specify units in offers

Each **offer** submitted by a **generator** must—

- (a) be specific to individual **generating units** for **generating plant** in respect of which **electricity** is offered by that **generator** that cannot **synchronise** and come up to minimum load within the duration of a **trading period**; or
- (b) be specific to individual **generating stations** for other **generating plant** in respect of which **electricity** is offered by that **generator**.

Compare: Electricity Governance Rules 2003 rule 3.7 section II part G

13.11 Offers may be made by unit or plant

- (1) Despite clause 13.10, a **generator**, other than an **intermittent generator**, may offer **electricity** in respect of any **generating plant** on a unit basis. A **generator** may exercise this option by giving the **system operator** at least 5 **business days**' notice in writing of the exercise of the option. The **system operator** must, during the 5 **business day** period, make any necessary changes to the scheduling **software**.
- (2) If a **generator** has offered **electricity** in respect of any **generating plant** on a unit basis in accordance with subclause (1), it may change to submitting **offers** in accordance with clause 13.10. Such a change may be effected by giving the **system operator** at least 5 **business days**' notice in writing of the change. The **system operator** must, during the 5 **business day** period, make any necessary changes to the scheduling **software**.

Compare: Electricity Governance Rules 2003 rule 3.8 section II part G

13.12 Offers may contain up to 5 price bands

Subject to clause 13.9(d), an **offer** submitted by a **generator** may have a maximum of 5 price bands for each **trading period**, with the 1st price band containing the lowest price offered, and each subsequent band having a higher price than the band preceding it.

Compare: Electricity Governance Rules 2003 rule 3.9 section II part G

Clause 13.12: amended, at 12.00 pm on 19 September 2019, by clause 8 of the Electricity Industry Participation Code Amendment (Wind Offer Arrangements) 2019.

13.13 Information to be contained in bids

- (1) A **purchaser** must ensure that each of its **nominated bids**—
 - (a) contains all information required by Form 4 in Schedule 13.1; and

- (aa) if it is a **nominated bid** for a **dispatch-capable load station**, specifies whether it is—
- (i) a **nominated dispatch bid**; or
 - (ii) a **nominated non-dispatch bid**.
- (b) *[Revoked]*
- (c) *[Revoked]*
- (1A) *[Revoked]*
- (2) A **purchaser** must ensure that each of its **difference bids** contains all information required by Form 4A in Schedule 13.1.
- Compare: Electricity Governance Rules 2003 rule 3.10 section II part G
- Clause 13.13: substituted, on 28 June 2012, by clause 11 of the Electricity Industry Participation (Demand-side Bidding and Forecasting) Code Amendment 2011.
- Clause 13.13(1)(aa): inserted, on 15 May 2014, by clause 13(a) of the Electricity Industry Participation (Modified Dispatchable Demand) Code Amendment 2013.
- Clause 13.13(1)(b): revoked, on 15 May 2014, by clause 13(b) of the Electricity Industry Participation (Modified Dispatchable Demand) Code Amendment 2013.
- Clause 13.13(1)(c): inserted, on 3 November 2016, by clause 4(1) of the Electricity Industry Participation Code Amendment (Dispatchable Demand During Tight Market Conditions) 2016.
- Clause 13.13(1)(c): revoked, on 1 November 2022, by clause 14(1) of the Electricity Industry Participation Code Amendment (Real Time Pricing) 2022.
- Clause 13.13(1A): inserted, on 3 November 2016, by clause 4(2) of the Electricity Industry Participation Code Amendment (Dispatchable Demand During Tight Market Conditions) 2016.
- Clause 13.13(1A): revoked, on 1 November 2022, by clause 14(2) of the Electricity Industry Participation Code Amendment (Real Time Pricing) 2022.
- Clause 13.13(2): substituted, on 15 May 2014, by clause 13(c) of the Electricity Industry Participation (Modified Dispatchable Demand) Code Amendment 2013.

13.14 Nominated bids may contain up to 10 price bands

- (1) A **nominated bid** submitted by a **purchaser** may have a maximum of 10 price bands for each **trading period**.
 - (2) The price in each band must decrease progressively from band to band as the aggregate quantity increases.
 - (3) The highest price band in each **nominated bid** is deemed to start at a quantity of 0.
- Compare: Electricity Governance Rules 2003 rule 3.11 section II part G
- Clause 13.14: substituted, on 28 June 2012, by clause 12 of the Electricity Industry Participation (Demand-side Bidding and Forecasting) Code Amendment 2011.

13.14A Difference bids may contain up to 10 price bands

A **difference bid** submitted by a **purchaser** may have a maximum of—

- (a) 5 price bands for each **trading period** representing the **purchaser's** progressive increase in its usual quantity of **electricity** demanded for the **trading period**. The price in bands 2 to 5 must, in each case, be lower than the price in the preceding band; and
- (b) 5 price bands for each **trading period** representing the **purchaser's** progressive decrease in its usual quantity of **electricity** demanded for the **trading period**. The price in bands 2 to 5 must, in each case, be higher than the price in the preceding band.

Clause 13.14A: inserted, on 28 June 2012, by clause 13 of the Electricity Industry Participation (Demand-side Bidding and Forecasting) Code Amendment 2011.

13.15 How price is to be specified in bids or offers

Prices in **bids** or **offers** must be expressed in dollars and whole cents per **MWh** excluding any **GST**. There is no upper limit on the prices that may be specified and the lower limit is \$0.00/**MWh**, subject to clauses 13.9(d), 13.24, 13.26, and 13.116.

Compare: Electricity Governance Rules 2003 rule 3.12 section II part G

Clause 13.15: amended, at 12.00 pm on 19 September 2019, by clause 9 of the Electricity Industry Participation Code Amendment (Wind Offer Arrangements) 2019.

13.16 How quantity is to be specified in bids or offers

For each price band, a **bid** or **offer** must specify a quantity expressed in **MW** to not more than 3 decimal places. The minimum quantity that may be bid or offered in a price band for a **trading period** is 0.000 **MW**.

Compare: Electricity Governance Rules 2003 rule 3.13 section II part G

Clause 13.16: amended, on 21 September 2012, by clause 18 of the Electricity Industry Participation (Minor Amendments) Code Amendment 2012.

13.17 Offers may be revised

- (1) Subject to subclauses (2) to (4), a **generator** may revise an **offer** at any time before the end of the **trading period** to which the **offer** relates by submitting a new **offer** to the **system operator**.
- (2) A **generator** must not revise any of its **offer** prices during a **gate closure period**.
- (3) A **generator** must not revise the **MW** specified in any price band in an **offer** during a **gate closure period**, unless clause 13.18(1), 13.18(1A), 13.19 or 13.19C applies.
- (4) A **generator** must not revise any of the following **offer** parameters during a **gate closure period**, unless clause 13.19 applies:
 - (a) ramp rates:
 - (b) maximum output (including overload).

Compare: Electricity Governance Rules 2003 rule 3.14 section II part G

Clause 13.17 Heading: amended, on 28 June 2012, by clause 14(1) of the Electricity Industry Participation (Demand-side Bidding and Forecasting) Code Amendment 2011.

Clause 13.17(1): amended, on 28 June 2012, by clause 14(2) of the Electricity Industry Participation (Demand-side Bidding and Forecasting) Code Amendment 2011.

Clause 13.17(1): amended, on 1 November 2022, by clause 15(1) of the Electricity Industry Participation Code Amendment (Real Time Pricing) 2022.

Clause 13.17: substituted, on 29 June 2017, by clause 14 of the Electricity Industry Participation Code Amendment (Shortened Gate Closure and Revised Bid and Offer Provisions) 2017.

Clause 13.17(3): amended, at 12.00 pm on 19 September 2019, by clause 10 of the Electricity Industry Participation Code Amendment (Wind Offer Arrangements) 2019.

Clause 13.17(3): amended, on 1 November 2022, by clause 15(2) of the Electricity Industry Participation Code Amendment (Real Time Pricing) 2022.

13.18 When revised offer to be submitted

- (1) A **generator**, other than an **intermittent generator**, must immediately submit a revised **offer** to the **system operator** if the total **MW** specified in an **offer** exceeds, by more than 5 **MW**, the total **MW** that the **generator** expects to be capable of generating at the relevant **point of connection** to the **grid** for the relevant **trading period**.
- (1A) A **generator**, other than an **intermittent generator**, may submit a revised **offer** to the **system operator** if the total **MW** specified in an **offer** exceeds, by 5 **MW** or less, the total **MW** that the **generator** expects to be capable of generating at the relevant **point of connection** to the **grid** for the relevant **trading period**.

(1B) The submission of a revised **offer** under subclause (1) or subclause (1A) does not relieve the **generator** of liability for breach of any other provision of this Code.

(2) *[Revoked]*

(3) *[Revoked]*

Compare: Electricity Governance Rules 2003 rules 3.15 and 3.16 section II part G

Clause 13.18 Heading: amended, on 28 June 2012, by clause 15(1) of the Electricity Industry Participation (Demand-side Bidding and Forecasting) Code Amendment 2011.

Clause 13.18 Heading: amended, on 29 June 2017, by clause 15(1) of the Electricity Industry Participation Code Amendment (Shortened Gate Closure and Revised Bid and Offer Provisions) 2017.

Clause 13.18(1): amended, on 28 June 2012, by clause 15(2) of the Electricity Industry Participation (Demand-side Bidding and Forecasting) Code Amendment 2011.

Clause 13.18(1): replaced, on 29 June 2017, by clause 15(2) of the Electricity Industry Participation Code Amendment (Shortened Gate Closure and Revised Bid and Offer Provisions) 2017.

Clause 13.18(1): amended, at 12.00 pm on 19 September 2019, by clause 11(1) of the Electricity Industry Participation Code Amendment (Wind Offer Arrangements) 2019.

Clause 13.18(1): amended, on 1 November 2022, by clause 16(1) of the Electricity Industry Participation Code Amendment (Real Time Pricing) 2022.

Clause 13.18(1A): inserted, on 28 June 2012, by clause 15(3) of the Electricity Industry Participation (Demand-side Bidding and Forecasting) Code Amendment 2011.

Clause 13.18(1A): replaced, on 29 June 2017, by clause 15(3) of the Electricity Industry Participation Code Amendment (Shortened Gate Closure and Revised Bid and Offer Provisions) 2017.

Clause 13.18(1A): amended, at 12.00 pm on 19 September 2019, by clause 11(2) of the Electricity Industry Participation Code Amendment (Wind Offer Arrangements) 2019.

Clause 13.18(1B): inserted, on 29 June 2017, by clause 15(3) of the Electricity Industry Participation Code Amendment (Shortened Gate Closure and Revised Bid and Offer Provisions) 2017.

Clause 13.18(2): amended, on 28 June 2012, by clause 15(4) of the Electricity Industry Participation (Demand-side Bidding and Forecasting) Code Amendment 2011.

Clause 13.18(2): revoked, on 29 June 2017, by clause 15(4) of the Electricity Industry Participation Code Amendment (Shortened Gate Closure and Revised Bid and Offer Provisions) 2017.

Clause 13.18(3): inserted, on 29 June 2017, by clause 15(5) of the Electricity Industry Participation Code Amendment (Shortened Gate Closure and Revised Bid and Offer Provisions) 2017.

Clause 13.18(3): replaced, at 12.00 pm on 19 September 2019, by clause 11(3) of the Electricity Industry Participation Code Amendment (Wind Offer Arrangements) 2019.

Clause 13.18(3): revoked, on 1 November 2022, by clause 16(2) of the Electricity Industry Participation Code Amendment (Real Time Pricing) 2022.

13.18A Intermittent generators to submit revised forecast of generation potential every trading period in last 2 hours

(1) During the 2 hours immediately preceding the **trading period** to which an **offer** relates, each **intermittent generator** must submit to the **system operator** a revised **forecast of generation potential** for the relevant **intermittent generating station** for the **trading period** at a frequency of at least 1 revised forecast per **trading period**.

(2) A revised **forecast of generation potential** submitted under subclause (1) must be based on a resource persistence model, unless otherwise agreed with the **Authority**.

(3) For the purposes of this clause, a resource persistence model means a method for producing a forecast of the **intermittent generator's** generation for a **trading period**, in **MW**, that is derived from the expected availability and capability of **generating plant** forming all or part of the relevant **intermittent generating station**, on the assumption that the variable resource conditions at the time at which the forecast is prepared will persist throughout the **trading period** to which the forecast relates.

Clause 13.18A: inserted, on 29 June 2017, by clause 16 of the Electricity Industry Participation Code Amendment (Shortened Gate Closure and Revised Bid and Offer Provisions) 2017.

Clause 13.18A: replaced, at 12.00 pm on 19 September 2019, by clause 12 of the Electricity Industry Participation Code Amendment (Wind Offer Arrangements) 2019.

Clause 13.18A(3): amended, on 20 March 2020, by clause 5 of the Electricity Industry Participation Code Amendment (Broadening Definitions of Generating Unit and Intermittent Generating Station) 2020.

13.19 When revised offers may be submitted during gate closure period

- (1) A **generator**, other than an **intermittent generator**, may submit a revised **offer** to the **system operator** during a **gate closure period** if—
- (a) the revision is necessary due to a **bona fide physical reason**; or
 - (b) the **system operator** issues a **formal notice** under clause 5 of **Technical Code B** of Schedule 8.3; or
 - (c) a **bona fide physical reason** that made a revision necessary under paragraph (a) ceases to exist sooner than was expected at the time it arose, and—
 - (i) the 1st **trading period** after the original **bona fide physical reason** ceases to exist is within 24 hours after the circumstances that constituted the original **bona fide physical reason** arose; and
 - (ii) the total change in **MW** specified in the **offer** that is revised as a result of the **bona fide physical reason** ceasing to exist is the same or less than the total change in **MW** specified in the **offer** that was made as a result of the original **bona fide physical reason**.
- (2) A **generator** that submits a revised **offer** under subclause (1)(c) must do so as soon as possible after the relevant **bona fide physical reason** ceases to exist.

Compare: Electricity Governance Rules 2003 rule 3.17 section II part G

Clause 13.19 Heading: amended, on 28 June 2012, by clause 16(1) of the Electricity Industry Participation (Demand-side Bidding and Forecasting) Code Amendment 2011.

Clause 13.19: amended, on 28 June 2012, by clause 16(2) of the Electricity Industry Participation (Demand-side Bidding and Forecasting) Code Amendment 2011.

Clause 13.19: substituted, on 29 June 2017, by clause 17 of the Electricity Industry Participation Code Amendment (Shortened Gate Closure and Revised Bid and Offer Provisions) 2017.

Clause 13.19(1): amended, at 12.00 pm on 19 September 2019, by clause 13 of the Electricity Industry Participation Code Amendment (Wind Offer Arrangements) 2019.

13.19AA Limitations on revised offers

A **generator** that submits a revised **offer** under clauses 13.18(1), 13.18(1A), or 13.19(1) during a **gate closure period** must ensure that—

- (a) the revised **offer** only differs from the original **offer** to the extent necessary to ensure that the **MW** specified in the revised **offer** is the **MW** that the **generator** expects to be capable of generating at the relevant **point of connection** to the **grid** for the relevant **trading period**; and
- (b) the revised **offer** complies with the following:
 - (i) the reduction in **MW** specified in the revised **offer** must be first deducted from the **MW** offered in the highest price band:
 - (ii) if the reduction in **MW** exceeds the **MW** in the highest price band, the remainder must be deducted from the price bands below the highest, in descending order as the **MW** in each price band is reduced to zero, until all of the reduction is reflected in the revised **offer**.

Clause 13.19AA: inserted, on 29 June 2017, by clause 17 of the Electricity Industry Participation Code Amendment (Shortened Gate Closure and Revised Bid and Offer Provisions) 2017.

13.19A Bids may be revised

- (1) Each **purchaser** may, at any time before the end of a **trading period** in respect of which a **bid** is made,—

- (a) revise any of its **bid** prices or the **MW** specified in any price band in a **bid** for any **trading period** by submitting a new **bid** to the **system operator**; or
- (aa) revise a **nominated bid**—
 - (i) from being a **nominated dispatch bid** to being a **nominated non-dispatch bid**; or
 - (ii) from being a **nominated non-dispatch bid** to being a **nominated dispatch bid**.
- (b) *[Revoked]*
- (1A) Despite subclause (1), a **dispatchable load purchaser** must not do any of the following during a **gate closure period**:
 - (a) revise the price of a **nominated dispatch bid**;
 - (b) revise the **MW** specified in any price band in a **nominated dispatch bid**, unless subclause (1B) or clause 13.19B applies.
 - (c) revise a **nominated non-dispatch bid** to being a **nominated dispatch bid**, unless the **system operator** declares a **grid emergency** in accordance with **Technical Code B** of Schedule 8.3.
- (1B) A **dispatchable load purchaser** may revise the **MW** specified in any price band in a **nominated dispatch bid** during a **gate closure period** if—
 - (a) the revision is necessary due to a **bona fide physical reason**; or
 - (b) the **system operator** has declared a **grid emergency**; or
 - (c) a **bona fide physical reason** that made a revision necessary under paragraph (a) ceases to exist sooner than was expected at the time it arose, and—
 - (i) the 1st **trading period** after the original **bona fide physical reason** ceases to exist is within 24 hours after the circumstances that constituted the original **bona fide physical reason** arose; and
 - (ii) the total change in **MW** specified in the **nominated dispatch bid** that is revised as a result of the **bona fide physical reason** ceasing to exist is the same or less than the total change in **MW** specified in the **nominated dispatch bid** that was made as a result of the original **bona fide physical reason**.
- (2) *[Revoked]*
- (3) *[Revoked]*
- (3A) *[Revoked]*
- (3B) *[Revoked]*
- (4) *[Revoked]*
- (5) *[Revoked]*
- (6) *[Revoked]*.

Clause 13.19A Heading: amended, on 29 June 2017, by clause 18(1) of the Electricity Industry Participation Code Amendment (Shortened Gate Closure and Revised Bid and Offer Provisions) 2017.

Clause 13.19A: inserted, on 28 June 2012, by clause 17 of the Electricity Industry Participation (Demand-side Bidding and Forecasting) Code Amendment 2011.

Clause 13.19A(1): amended, on 29 June 2017, by clause 18(2) of the Electricity Industry Participation Code Amendment (Shortened Gate Closure and Revised Bid and Offer Provisions) 2017.

Clause 13.19A(1): amended, on 1 November 2022, by clause 17(1) of the Electricity Industry Participation Code Amendment (Real Time Pricing) 2022.

Clause 13.19A(1)(a): amended, on 29 June 2017, by clause 18(3) of the Electricity Industry Participation Code Amendment (Shortened Gate Closure and Revised Bid and Offer Provisions) 2017.

Clause 13.19A(1)(aa): inserted, on 15 May 2014, by clause 14(1) of the Electricity Industry Participation (Modified Dispatchable Demand) Code Amendment 2013.

Clause 13.19A(1)(aa)(ii): amended, on 29 June 2017, by clause 18(4) of the Electricity Industry Participation Code Amendment (Shortened Gate Closure and Revised Bid and Offer Provisions) 2017.

Clause 13.19A(1)(b): revoked, on 29 June 2017, by clause 18(5) of the Electricity Industry Participation Code Amendment (Shortened Gate Closure and Revised Bid and Offer Provisions) 2017.

Clause 13.19A(1A) and (1B): inserted, on 29 June 2017, by clause 18(6) of the Electricity Industry Participation Code Amendment (Shortened Gate Closure and Revised Bid and Offer Provisions) 2017.

Clause 13.19A(1A) (c): inserted, on 1 November 2022, by clause 17(2) of the Electricity Industry Participation Code Amendment (Real Time Pricing) 2022.

Clause 13.19A(1B) (b): amended, on 1 November 2022, by clause 17(3) of the Electricity Industry Participation Code Amendment (Real Time Pricing) 2022.

Clause 13.19A(2)(ba): inserted, on 15 May 2014, by clause 14(2) of the Electricity Industry Participation (Modified Dispatchable Demand) Code Amendment 2013.

Clause 13.19A(3)(a)(ia): inserted, on 15 May 2014, by clause 14(3) of the Electricity Industry Participation (Modified Dispatchable Demand) Code Amendment 2013.

Clause 13.19A(3)(b): substituted, on 15 May 2014, by clause 14(4) of the Electricity Industry Participation (Modified Dispatchable Demand) Code Amendment 2013.

Clause 13.19A(3)(c): amended, on 15 May 2014, by clause 14(5) of the Electricity Industry Participation (Modified Dispatchable Demand) Code Amendment 2013.

Clause 13.19A(2), (3), (4) and (5): revoked, on 29 June 2017, by clause 18(7) of the Electricity Industry Participation Code Amendment (Shortened Gate Closure and Revised Bid and Offer Provisions) 2017.

Clause 13.19A(3A): inserted, on 1 December 2015, by clause 4 of the Electricity Industry Participation Code Amendment (Dispatchable Demand: Late Bid Revisions) 2015.

Clause 13.19A(3B): inserted, on 29 June 2017, by clause 18(8) of the Electricity Industry Participation Code Amendment (Shortened Gate Closure and Revised Bid and Offer Provisions) 2017.

Clause 13.19A(6): inserted, on 29 June 2017, by clause 18(9) of the Electricity Industry Participation Code Amendment (Shortened Gate Closure and Revised Bid and Offer Provisions) 2017.

Clauses 13.19A(3A), (3B) and (6): revoked, on 1 November 2022, by clause 17(4) of the Electricity Industry Participation Code Amendment (Real Time Pricing) 2022.

13.19B Bids must be revised

- (1) Before the end of the **trading period** to which a **nominated bid** relates, the **purchaser** that submitted the **nominated bid** must immediately submit a revised **nominated bid** in respect of **MW** to the **system operator** if the **purchaser** expects, or ought reasonably to expect, that the **MW** it is likely to purchase at the prices indicated in the **nominated bid** will,—
 - (a) if the **nominated bid** is a **nominated non-dispatch bid**, differ from the **MW** specified in the **nominated bid** by more than the lesser of—
 - (i) 20 **MW**; and
 - (ii) 20% of the **nominated bid MW**; or
 - (b) if the **nominated bid** is a **nominated dispatch bid**, differ from the **MW** specified in the **nominated bid** by more than the lesser of—
 - (i) 10 **MW**; and
 - (ii) 10% of the **nominated bid MW**.

- (2) Despite subclause (1), a **purchaser** is not required to submit a revised **nominated bid** in respect of **MW** if the expected change in **MW** is less than 5 **MW**.

Clause 13.19B: inserted, on 29 June 2017, by clause 19 of the Electricity Industry Participation Code Amendment (Shortened Gate Closure and Revised Bid and Offer Provisions) 2017.

Clause 13.19B(1): amended, on 1 November 2022, by clause 18 of the Electricity Industry Participation Code Amendment (Real Time Pricing) 2022.

13.19C Dispatch notification purchasers and dispatch notification generators to submit revised bids and offers in certain circumstances

- (1) If a **dispatch notification purchaser** does not intend to comply with a **nominated dispatch bid** that is the subject of a **dispatch notification**, the **dispatch notification**

purchaser must immediately revise the **nominated dispatch bid** to be a **nominated non-dispatch bid**.

- (2) If a **dispatch notification generator** does not intend to comply with an **offer** that is the subject of a **dispatch notification**, the **dispatch notification generator** must immediately revise the **MW** specified in the **offer** to 0.
- (3) A **dispatch notification purchaser** that submits a revised **bid** under this clause—
 - (a) is deemed to have submitted a **nominated non-dispatch bid** for the **trading period** following the **trading period** to which the revised **bid** relates; and
 - (b) despite clauses 13.19A and 13.19B, must not submit a revised **bid** for the **trading period** to which the revised **bid** relates or the next **trading period**.
- (4) A **dispatch notification generator** that submits a revised **offer** under this clause—
 - (a) is deemed to have submitted an **offer** in which the **MW** specified in the offer is 0 for the **trading period** following the **trading period** to which the revised **offer** relates; and
 - (b) despite clauses 13.17 and 13.19, must not submit a revised **offer** for the **trading period** to which the revised **offer** relates or the next **trading period**.

Clause 13.19C: inserted, on 1 November 2022, by clause 19 of the Electricity Industry Participation Code Amendment (Real Time Pricing) 2022.

13.20 System operator advised of revised nominated bids or offers in certain circumstances

- (1) This clause applies to each **purchaser** or **generator** that submits a revised **nominated bid** or **offer** in the period commencing 15 minutes before the **trading period** to which the revised **nominated bid** or **offer** relates and ending at the end of that **trading period**.
- (2) Subject to subclause (4), a **purchaser** or **generator** that submits a revised **nominated bid** or **offer** in the time frame described in subclause (1) must immediately advise the **system operator** of the revision.
- (3) Subclause (2) does not apply to an **intermittent generator** submitting a revised **forecast of generation potential** under clause 13.18A.
- (4) Despite subclause (2), if the **system operator** and a **purchaser** or **generator** have entered into a written agreement relating to the notification of revised **nominated bids** or **offers**, the **purchaser** or **generator**—
 - (a) must submit a revised **nominated bid** or **offer** in accordance with that agreement; but
 - (b) if the agreement provides that the **purchaser** or **generator** is not required to advise the **system operator** of revised **nominated bids** or **offers**, the **purchaser** or **generator** is not required to do so.

Compare: Electricity Governance Rules 2003 rule 3.18 section II part G

Clause 13.20 Heading: amended, on 5 October 2017, by clause 336(1) of the Electricity Industry Participation Code Amendment (Code Review Programme) 2017.

Clause 13.20: substituted, on 28 June 2012, by clause 18 of the Electricity Industry Participation (Demand-side Bidding and Forecasting) Code Amendment 2011.

Clause 13.20: substituted, on 29 June 2017, by clause 20 of the Electricity Industry Participation Code Amendment (Shortened Gate Closure and Revised Bid and Offer Provisions) 2017.

Clause 13.20: amended, on 1 November 2022, by clause 20 of the Electricity Industry Participation Code Amendment (Real Time Pricing) 2022.

Clause 13.20(1): amended, on 15 May 2014, by clause 15 of the Electricity Industry Participation (Modified Dispatchable Demand) Code Amendment 2013.

Clause 13.20(2): amended, on 5 October 2017, by clause 336(2) of the Electricity Industry Participation Code Amendment (Code Review Programme) 2017.

Clause 13.20(3): amended, at 12.00 pm on 19 September 2019, by clause 14 of the Electricity Industry Participation Code Amendment (Wind Offer Arrangements) 2019.

13.21 Authority informed of revised nominated dispatch bid or offer during gate closure period

- (1) A **dispatchable load purchaser** or **generator** that submits a revised **nominated dispatch bid** or a revised **offer** to the **system operator** during a **gate closure period** must report each revision to the **Authority** in writing together with an explanation of the reasons for the revision.
- (1A) The **dispatchable load purchaser** or **generator** must report the revision to the **Authority** no later than 1700 hours on the 1st **business day** following the **trading day** on which the revision was made.
- (1B) Subclauses (1) and (1A) do not apply to an **intermittent generator** submitting a revised **forecast of generation potential** under clause 13.18A.
- (2) *[Revoked]*

Compare: Electricity Governance Rules 2003 rules 3.19 and 3.20 section II part G

Clause 13.21 Heading: amended, on 28 June 2012, by clause 19(1) of the Electricity Industry Participation (Demand-side Bidding and Forecasting) Code Amendment 2011.

Clause 13.21 Heading: replaced, on 29 June 2017, by clause 21(1) of the Electricity Industry Participation Code Amendment (Shortened Gate Closure and Revised Bid and Offer Provisions) 2017.

Clause 13.21 Heading: amended, on 5 October 2017, by clause 337 of the Electricity Industry Participation Code Amendment (Code Review Programme) 2017.

Clause 13.21(1): amended, on 28 June 2012, by clause 19(2) of the Electricity Industry Participation (Demand-side Bidding and Forecasting) Code Amendment 2011.

Clause 13.21(1): replaced, on 29 June 2017, by clause 21(2) of the Electricity Industry Participation Code Amendment (Shortened Gate Closure and Revised Bid and Offer Provisions) 2017.

Clause 13.21(2): amended, on 28 June 2012, by clause 19(3) of the Electricity Industry Participation (Demand-side Bidding and Forecasting) Code Amendment 2011.

Clause 13.21(1A) and (1B): inserted, on 29 June 2017, by clause 21(2) of the Electricity Industry Participation Code Amendment (Shortened Gate Closure and Revised Bid and Offer Provisions) 2017.

Clause 13.21(1B): amended, at 12.00 pm on 19 September 2019, by clause 15 of the Electricity Industry Participation Code Amendment (Wind Offer Arrangements) 2019.

Clause 13.21(2): revoked, on 29 June 2017, by clause 21(3) of the Electricity Industry Participation Code Amendment (Shortened Gate Closure and Revised Bid and Offer Provisions) 2017.

13.22 Transmission of information

- (1) Except where specified otherwise in clauses 13.6 to 13.27, all information that a **purchaser** or **generator** must submit under clauses 13.6 to 13.27 must be submitted to the **system operator** using **WITS**.
- (2) The **system operator** must immediately confirm receipt of any information that the **system operator** receives from a **purchaser** or **generator** under clauses 13.6 to 13.27. Each confirmation must contain a copy of the information received by the **system operator** together with the time of receipt.
- (3) If a **purchaser** or **generator** has not received the confirmation within 10 minutes of submitting the information under clauses 13.6 to 13.27 to the **system operator**, the **purchaser** or **generator** must—
 - (a) check whether the **system operator** has received the information; and
 - (b) if the **system operator** has not received the information, resend the information; and
 - (c) repeat the process set out in this clause until the **system operator** has confirmed receipt of the information from the **purchaser** or **generator**.

Compare: Electricity Governance Rules 2003 rules 3.21 to 3.23 section II part G

Clause 13.22(3): amended, on 28 June 2012, by clause 20 of the Electricity Industry Participation (Demand-side Bidding and Forecasting) Code Amendment 2011.

Clause 13.22: replaced, on 5 October 2017, by clause 338 of the Electricity Industry Participation Code Amendment (Code Review Programme) 2017.

13.23 Backup procedures if WITS is unavailable

- (1) If **WITS** is unavailable to receive **bids** or **offers** or to confirm the receipt of **bids** or **offers**, each **purchaser** and **generator** or the **system operator**, as the case may be, must follow the backup procedures agreed between the **WITS manager** and the **Authority** and published by the **Authority**.
- (2) *[Revoked]*

Compare: Electricity Governance Rules 2003 rules 3.24 and 3.25 section II part G

Clause 13.23 Heading: amended, on 5 October 2017, by clause 339(1) of the Electricity Industry Participation Code Amendment (Code Review Programme) 2017.

Clause 13.23: amended, on 5 October 2017, by clause 339(2), (3) and (4) of the Electricity Industry Participation Code Amendment (Code Review Programme) 2017.

Clause 13.23(1): amended, on 1 March 2024, by clause 70(1) of the Electricity Industry Participation Code Amendment (Code Review Programme) 2024.

Clause 13.23(2): revoked, on 1 March 2024, by clause 70(2) of the Electricity Industry Participation Code Amendment (Code Review Programme) 2024.

13.24 Plant with special circumstances

Despite clause 13.18(1), a **generator** is not required to submit a revised **offer** in respect of an **automatic control plant** if—

- (a) the **offer** submitted in respect of the **automatic control plant** is based on a profile of the pre-programmed levels of the **automatic control plant**; and
- (b) the **offer** is made at a 0 price and clause 13.116(2) applies to the **generator**; and
- (c) the **offer** is otherwise made in accordance with clauses 13.6 to 13.27; and
- (d) the **system operator** has confirmed in writing to the **generator** that it is satisfied that the **offer** meets the requirements of the **dispatch objective**; and
- (e) the **generator** expects that the ability of the **automatic control plant** to generate the quantity scheduled for a **trading period** at a **grid injection point** will not change by more than 10 **MW** of the scheduled quantity.

Compare: Electricity Governance Rules 2003 rule 3.26 section II part G

Clause 13.24: amended, on 20 December 2021, by clause 54 of the Electricity Industry Participation Code Amendment (Code Review Programme) 2019.

13.25 Exception for small generation

- (1) Despite clause 13.6(1), a **generator** is not required to submit an **offer** for a **generating station** that is 10 **MW** or smaller and any **electricity** sold to the **clearing manager** from the **generating station** is regarded as **unoffered generation** for the purpose of this Code.
- (2) The **system operator** may require the relevant **generator** to provide information in a form reasonably determined by the **system operator** on the expected generation output for any **unoffered generation** from a **generating station** with a **point of connection to the grid**.

Compare: Electricity Governance Rules 2003 rule 3.27 section II part G

Clause 13.25(1): amended, on 29 June 2017, by clause 22 of the Electricity Industry Participation Code Amendment (Shortened Gate Closure and Revised Bid and Offer Provisions) 2017.

13.26 Exception for embedded generation

An **embedded generator** required to submit an **offer** in accordance with clause 8.25(5) may make an **offer** at a 0 price and clause 13.116(2) applies to the **embedded generator**.

Compare: Electricity Governance Rules 2003 rule 3.28 section II part G

13.27 System operator to retain bids and offers

The **system operator** must retain, in a form that it considers appropriate, all **bids and offers** for electricity submitted by **participants** under this subpart, including all revised **bids and offers**.

Compare: Electricity Governance Rules 2003 rule 3.29 section II part G

Clause 13.27: amended, on 29 June 2017, by clause 23 of the Electricity Industry Participation Code Amendment (Shortened Gate Closure and Revised Bid and Offer Provisions) 2017.

Process for determining conforming and non-conforming grid exit points

Heading: inserted, on 28 March 2012, by clause 21 of the Electricity Industry Participation (Demand-side Bidding and Forecasting) Code Amendment 2011.

13.27A Authority determines conforming and non-conforming GXPs on own initiative

The **Authority** may, on its own initiative,—

- (a) determine whether a **GXP**, which is deemed to be a **conforming GXP** under clause 13.27F, is a **conforming GXP** or a **non-conforming GXP**;
- (b) reconsider a previous determination, and as a result may decide to replace the previous determination with a new determination.

Clause 13.27A: inserted, on 28 March 2012, by clause 21 of the Electricity Industry Participation (Demand-side Bidding and Forecasting) Code Amendment 2011.

13.27B Authority to determine conforming and non-conforming GXPs if requested

- (1) Subclause (4) applies if—
 - (a) a **purchaser** or the **system operator** makes a request under clause 13.27H; and
 - (b) the **Authority** decides there are valid grounds to consider the request.
- (2) The **Authority** must decide whether to proceed with the request within a reasonable time after receiving the request.
- (3) If the **Authority** decides there are no valid grounds to consider the request, the **Authority** must give written notice to the requester of—
 - (a) the **Authority's** decision; and
 - (b) the grounds for the **Authority's** decision.
- (4) If subclause (1) applies, the **Authority** must—
 - (a) determine whether a **GXP**, which is deemed to be a **conforming GXP** under clause 13.27F, is a **conforming GXP** or a **non-conforming GXP**;
 - (b) reconsider a previous determination, and as a result may decide to replace the previous determination with a new determination.

Clause 13.27B: inserted, on 28 March 2012, by clause 21 of the Electricity Industry Participation (Demand-side Bidding and Forecasting) Code Amendment 2011.

Clause 13.27B(3): amended, on 5 October 2017, by clause 340 of the Electricity Industry Participation Code Amendment (Code Review Programme) 2017.

13.27C Process for making determination

- (1) In making a determination, the **Authority** must—
 - (a) apply the methodology set out in Schedule 13.7; and
 - (b) request and take into account advice from the **system operator**; and
 - (c) take into account any information submitted by a **purchaser** who purchases **electricity** at the **GXP**.
- (2) The **Authority** must make a determination in accordance with the methodology in Schedule 13.7, unless—
 - (a) the **Authority** has applied the methodology; and
 - (b) according to the methodology, the **GXP** is a **conforming GXP**; and
 - (c) the **Authority** considers that the **GXP** should be treated as a **non-conforming GXP**; and
 - (d) the **Authority** has **published** criteria under clause 13.27E; and
 - (e) making a determination that the **GXP** is a **non-conforming GXP** is in accordance with the criteria.
- (3) If paragraphs (a) to (e) in subclause (2) apply, the **Authority** may make a determination in accordance with the criteria **published** under clause 13.27E.
- (4) As soon as practicable after making a determination, the **Authority** must—
 - (a) advise the **WITS manager**, all **purchasers**, and the **system operator**—
 - (i) of its determination; and
 - (ii) whether, in making the determination, the **Authority** has followed—
 - (A) the methodology set out in Schedule 13.7; or
 - (B) the criteria **published** under clause 13.27E; and
 - (b) advise all **purchasers** and the **system operator** of the right to request, under clause 13.27H, a reconsideration of the determination; and
 - (c) if the determination was requested under clause 13.27H, provide reasons for its decision to the requester.

Clause 13.27C Heading: amended, on 5 October 2017, by clause 341(1) of the Electricity Industry Participation Code Amendment (Code Review Programme) 2017.

Clause 13.27C: inserted, on 28 March 2012, by clause 21 of the Electricity Industry Participation (Demand-side Bidding and Forecasting) Code Amendment 2011.

Clause 13.27C(2)(d), (3) and (4)(a)(ii)(B): amended, on 5 October 2017, by clause 341(2) of the Electricity Industry Participation Code Amendment (Code Review Programme) 2017.

Clause 13.27C(4): amended, on 27 June 2012, by clause 7 of the Electricity Industry Participation (Demand-side Bidding and Forecasting) Code Amendment 2011, Amendment 2012.

Clause 13.27(4)(a): amended, on 5 October 2017, by clause 341(3) of the Electricity Industry Participation Code Amendment (Code Review Programme) 2017.

13.27D System operator to provide advice within reasonable time

The **system operator** must provide the advice requested under clause 13.27C(1)(b) within a reasonable time specified by the **Authority**.

Clause 13.27D: inserted, on 28 March 2012, by clause 21 of the Electricity Industry Participation (Demand-side Bidding and Forecasting) Code Amendment 2011.

13.27E Authority may publish criteria for determining GXP to be non-conforming

- (1) The **Authority** may **publish** criteria that set out the circumstances in which the **Authority** may make a determination that does not follow the methodology set out in Schedule 13.7.
- (2) The **Authority** must consult with **participants** before—
 - (a) **publishing** the criteria under subclause (1):
 - (b) **amending** the criteria **published** under subclause (1).

Clause 13.27E Heading: amended, on 5 October 2017, by clause 342(1) of the Electricity Industry Participation Code Amendment (Code Review Programme) 2017.

Clause 13.27E: inserted, on 28 March 2012, by clause 21 of the Electricity Industry Participation (Demand-side Bidding and Forecasting) Code Amendment 2011.

Clause 13.27E: amended, on 5 October 2017, by clause 342(2) of the Electricity Industry Participation Code Amendment (Code Review Programme) 2017.

13.27F GXP deemed to be conforming GXP before determination is made

If the **Authority** has not made a determination for a **GXP**, the **GXP** is deemed to be a **conforming GXP** until the **Authority** determines otherwise.

Clause 13.27F: inserted, on 28 March 2012, by clause 21 of the Electricity Industry Participation (Demand-side Bidding and Forecasting) Code Amendment 2011.

13.27G Authority must publish and maintain list of non-conforming and conforming GXPs

The **Authority** must **publish** and maintain a list of all **non-conforming GXPs** and all **conforming GXPs**, including—

- (a) the mean **demand** (in **MW**) for each **GXP** calculated in accordance with clause 1(b) of Schedule 13.7; and
- (b) if the mean **demand** for a **GXP** is 10 **MW** or more, the unpredictability measure for the **GXP** calculated in accordance with clause 1(c) of Schedule 13.7.

Clause 13.27G Heading: amended, on 5 October 2017, by clause 343(1) of the Electricity Industry Participation Code Amendment (Code Review Programme) 2017.

Clause 13.27G: inserted, on 28 March 2012, by clause 21 of the Electricity Industry Participation (Demand-side Bidding and Forecasting) Code Amendment 2011.

Clause 13.27G: amended, on 5 October 2017, by clause 343(2) of the Electricity Industry Participation Code Amendment (Code Review Programme) 2017.

13.27H Right to request determination or reconsideration of determination

- (1) A **purchaser** may request that the **Authority**—
 - (a) determine whether a **GXP** is a **conforming GXP** or a **non-conforming GXP**, in respect of a **GXP**—
 - (i) at which the **purchaser** purchases **electricity**; and
 - (ii) which is deemed to be a **conforming GXP** under clause 13.27F:
 - (b) reconsider a determination made under clause 13.27A or clause 13.27B(4) for a **GXP** at which the **purchaser** purchases **electricity**.
- (2) The **system operator** may request that the **Authority**—
 - (a) determine whether a **GXP**, which is deemed to be a **conforming GXP** under clause 13.27F, is a **conforming GXP** or a **non-conforming GXP**:
 - (b) reconsider a determination made under clause 13.27A or clause 13.27B(4).
- (3) The person making the request may provide the **Authority** with information that the person considers relevant to its request.

Clause 13.27H: inserted, on 28 March 2012, by clause 21 of the Electricity Industry Participation (Demand-side Bidding and Forecasting) Code Amendment 2011.

13.27I Effect of determination

- (1) When making a determination, the **Authority** must specify a date and a **trading period** from which the determination takes effect.
- (2) The **Authority** must not specify a date that is earlier than **5 business days** after the date on which the **Authority** makes the determination.

Clause 13.27I: inserted, on 28 March 2012, by clause 21 of the Electricity Industry Participation (Demand-side Bidding and Forecasting) Code Amendment 2011.

13.27J New GXPs

At least 1 month before a **grid owner** connects a **GXP** to the **grid** for the first time, the **grid owner** must advise the **Authority** in writing of its intention to connect the **GXP**.

Clause 13.27J: inserted, on 28 March 2012, by clause 21 of the Electricity Industry Participation (Demand-side Bidding and Forecasting) Code Amendment 2011.

Clause 13.27J: amended, on 23 February 2015, by clause 75 of the Electricity Industry Participation Code Amendment (Distributed Generation) 2014.

Clause 13.27J: amended, on 5 October 2017, by clause 344 of the Electricity Industry Participation Code Amendment (Code Review Programme) 2017.

13.27K Authority to provide information at purchaser's request

- (1) After the **Authority** has made a determination under clause 13.27A or clause 13.27B(4) for a **GXP**, a **purchaser** who purchases **electricity** at the **GXP** may request from the **Authority** the following information in relation to the **GXP**:
 - (a) reconciled **half hour demand** data (in **MW**), as described in clause 2(1)(a) of Schedule 13.7;
 - (b) information about the way in which **demand** switching information (described in clause 2(1)(b) of Schedule 13.7) has been used to prepare the adjusted reconciled **half hour demand** data described in clause 1(a) of Schedule 13.7;
 - (c) information about the one-off events described in clause 2(1)(c) and clause 2(3) of Schedule 13.7 and the way in which those one-off events have been used to prepare the adjusted reconciled **half hour demand** data described in clause 1(a) of Schedule 13.7;
 - (d) the adjusted reconciled **half hour demand** data (in **MW**), as described in clause 1(a) of Schedule 13.7;
 - (e) the estimates of the adjusted reconciled **half hour demand** produced by the statistical predictive model under clause 3(1)(a) of Schedule 13.7, and the residuals calculated under clause 3(1)(b) of Schedule 13.7.
- (2) If a **purchaser** requests information under subclause (1), the **Authority** must provide the information if the information—
 - (a) is available to the **Authority**; and
 - (b) is not confidential; and
 - (c) is not commercially sensitive.

Clause 13.27K: inserted, on 28 March 2012, by clause 21 of the Electricity Industry Participation (Demand-side Bidding and Forecasting) Code Amendment 2011.

Special treatment of some grid exit points

Heading: inserted, on 28 June 2012, by clause 22 of the Electricity Industry Participation (Demand-side Bidding and Forecasting) Code Amendment 2011.

13.28 Special treatment of some grid exit points

- (1) For the purpose of this subpart and subparts 2 and 4, a **purchaser, generator or market operation service provider** may apply to the **Authority** to have 2 or more **grid exit points** treated as 1 **grid exit point** for the purposes of determining the status of a **GXP** under clause 13.27A or clause 13.27B(4), submitting **bids**, scheduling, switching, **dispatch**, pricing, clearing and settlement where there are 2 or more **local networks** supplied from the **grid** at the same physical location.
- (2) In determining an application under subclause (1), the **Authority** must consider the following factors:
 - (a) the efficiency or otherwise, of creating a separate price for **grid exit points** that are at the same, or at a geographically similar location:
 - (b) the geographical similarity of the **grid exit points** that are the subject of the application:
 - (c) the effect on a **market operation service provider** in terms of added processing time and complexity in treating as separate 2 or more **grid exit points** that are in the same or in a geographically similar location:
 - (d) any submissions received from **participants** under subclause (3):
 - (e) any other matter the **Authority** thinks fit.
- (3) The **Authority** must give written notice to **participants** of an application under subclause (1) within 2 **business days** of the application being received by the **Authority**. Each **participant** has 5 **business days** to make submissions to the **Authority** on the application. The **Authority** must not consider an application until after the period for making submissions on the application has expired.
- (4) If an application under subclause (1) has been approved, the **Authority** must consult with each **market operation service provider** about the time it may take to implement changes that are required to accommodate the decision. The **Authority** must then give written notice to each **participant** of the date from which its decision takes effect.

Compare: Electricity Governance Rules 2003 rule 4 section II part G

Clause 13.28(1): amended, on 28 June 2012, by clause 23 of the Electricity Industry Participation (Demand-side Bidding and Forecasting) Code Amendment 2011.

Clause 13.28(3) and (4): amended, on 5 October 2017, by clause 345 of the Electricity Industry Participation Code Amendment (Code Review Programme) 2017.

Information from grid owners

13.29 Standing data on grid capability to be provided to system operator

In addition to the **asset owner** obligations to provide information under clauses 2(5) and (6) and 3(1) of **Technical Code A** of Schedule 8.3, each **grid owner** must provide standing data on the capability of the transmission system to the **system operator** that is consistent with the configuration of the transmission system in the algorithms described in Schedule 13.3. The transmission data must include—

- (a) AC system configuration, including the transmission **lines**; and

- (b) AC system capacity including the limits of each transmission line of the transmission system; and
- (c) AC system loss characteristics including transmission loss functions for each transmission line of the transmission system.

Compare: Electricity Governance Rules 2003 rule 5.1 section II part G
Clause 13.29(a): amended, on 1 February 2016, by clause 77 of the Electricity Industry Participation Code Amendment (Code Review Programme) 2015.

13.30 Standing data on HVDC capability to be provided to system operator

- (1) In addition to the **asset owner** obligations to provide information under clauses 2(5) and (6), and 3(1) of **Technical Code A** of Schedule 8.3, the **HVDC owner** must provide standing data on the capability of the **HVDC link** to the **system operator** consistent with the **HVDC link configuration**.
- (2) The data provided under subclause (1) must include—
 - (a) the HVDC transmission **lines** and system capacity, including reserve capacity; and
 - (b) **HVDC link** capacity, including limits of each HVDC transmission line of the HVDC transmission system; and
 - (c) HVDC system loss characteristics including transmission loss functions for each transmission line of the HVDC transmission system; and
 - (d) in relation to Pole 2, or Pole 3, or Pole 2 and Pole 3, of the **HVDC link**—
 - (i) if the **HVDC owner** imposes a limit on transfer direction, the direction of that transfer limit (northward or southward); and
 - (ii) if the **HVDC owner** imposes a minimum transfer limit, that minimum transfer limit (in **MW**); and
 - (iii) if the **HVDC owner** imposes a maximum transfer limit, that maximum transfer limit (in **MW**).
- (3) Subclause (2)(d) applies only if—
 - (a) the **HVDC owner** is operating the **HVDC link** in accordance with—
 - (i) a **commissioning** plan agreed with the **system operator** under clause 2(6) to (9) of **Technical Code A** of Schedule 8.3; or
 - (ii) a test plan provided to the **system operator** under clause 2(6) to (9) of **Technical Code A** of Schedule 8.3; and
 - (b) the **HVDC link configuration** is—
 - (i) Pole 3 and Pole 2 bipole **round power**; or
 - (ii) Pole 3 and Pole 2 bipole not **round power**.

Compare: Electricity Governance Rules 2003 rule 5.2 section II part G
Clause 13.30: substituted, on 1 November 2012, by clause 4 of the Electricity Industry Participation (HVDC Link Pole 3 Standing Data) Code Amendment 2012.
Clause 13.30(2)(a): amended, on 1 February 2016, by clause 78 of the Electricity Industry Participation Code Amendment (Code Review Programme) 2015.
Clause 13.30(2)(d): amended, on 26 September 2013, by clause 5 of the Electricity Industry Participation (HVDC Link Bipole Control System Testing) Code Amendment 2013.
Clause 13.30(3)(a)(i): amended, on 5 October 2017, by clause 346 of the Electricity Industry Participation Code Amendment (Code Review Programme) 2017.
Clause 13.30(1): amended, on 1 March 2024, by clause 71(1) of the Electricity Industry Participation Code Amendment (Code Review Programme) 2024.

Clause 13.30(3)(b): amended, on 1 March 2024, by clause 71(2) of the Electricity Industry Participation Code Amendment (Code Review Programme) 2024.

13.31 Standing data on transformer capability to be provided to system operator

In addition to the **asset owner** obligations to provide information under clauses 2(5) and (6), and 3(1) of **Technical Code A** of Schedule 8.3 each **grid owner** must provide standing data on the capability of transformers to the **system operator** consistent with the configuration of those transformers. The data must include—

- (a) the transformer capacity of each transformer; and
- (b) the transformer loss characteristics, including transformer loss functions, for each transformer.

Compare: Electricity Governance Rules 2003 rule 5.3 section II part G

13.32 Transmission grid capability information to be updated

In addition to the **asset owner** obligations to provide information under clauses 2(5) and (6) of **Technical Code A** of Schedule 8.3, and subject to any timetable agreed with the **system operator** under clause 3(1) of **Technical Code A** of Schedule 8.3, each **grid owner** must submit to the **system operator** for each **trading period** of a **schedule period**, or for such longer period of time as agreed between the **system operator** and each **grid owner**, any updates to the information described in clauses 13.29 to 13.31 and 13.33(d).

Compare: Electricity Governance Rules 2003 rule 5.4 section II part G

Clause 13.32: amended, on 28 June 2012, by clause 24 of the Electricity Industry Participation (Demand-side Bidding and Forecasting) Code Amendment 2011.

13.33 Grid owners must submit revised information to system operator

Up to 1 hour before the beginning of the relevant **trading period**, but subject to any timetable agreed with the **system operator** under clause 3(1) of **Technical Code A** of Schedule 8.3, each **grid owner** must immediately submit revised information to the **system operator** if there has been or is likely to be—

- (a) a change to the information described in clauses 13.29 or 13.30; or
- (b) a change of 5% or more in the capacity limit of any transmission line of the transmission system, of the **HVDC link**, or of any transformer, represented in the algorithms described in Schedule 13.3; or
- (c) a change to loss characteristics, including loss functions, for any transmission line of the transmission system or of the **HVDC link**, or for any transformer, represented in the algorithms described in Schedule 13.3 that causes any **losses** or **marginal losses** to change by 5% or more; or
- (d) a change in the availability of **assets** forming part of the **grid**.

Compare: Electricity Governance Rules 2003 rule 5.5 section II part G

Clause 13.33: amended, on 29 June 2017, by clause 24 of the Electricity Industry Participation Code Amendment (Shortened Gate Closure and Revised Bid and Offer Provisions) 2017.

Clause 13.33: amended, on 20 December 2021, by clause 55 of the Electricity Industry Participation Code Amendment (Code Review Programme) 2019.

13.34 Changes may be made later than 1 hour before trading period

- (1) A **grid owner** may update the information submitted under clause 13.33 during the period commencing 1 hour before the relevant **trading period** and ending at the end of the relevant **trading period** only if—
 - (a) a **bona fide physical reason** necessitates the change; or
 - (b) the **system operator** issues a **formal notice**; or
 - (c) an unforeseeable change occurs in the availability of a **grid owner's assets**, which were the subject of a planned or unplanned outage in relation to which the **grid owner** gave written notice to the **system operator**.
- (2) If a **grid owner** has sent revised information to the **system operator** under subclause (1) later than 15 minutes before the relevant **trading period**, the **grid owner** must also immediately advise the **system operator** of the revised information by telephone or by such other mechanism as may be agreed from time to time in writing between **grid owners** and the **system operator**.
- (3) *[Revoked]*
- (4) *[Revoked]*

Compare: Electricity Governance Rules 2003 rules 5.6 to 5.9 section II part G

Clause 13.34 Heading: amended, on 29 June 2017, by clause 25(1) of the Electricity Industry Participation Code Amendment (Shortened Gate Closure and Revised Bid and Offer Provisions) 2017.

Clause 13.34 Heading: amended, on 1 November 2022, by clause 21(1) of the Electricity Industry Participation Code Amendment (Real Time Pricing) 2022.

Clause 13.34(1): amended, on 29 June 2017, by clause 25(2) of the Electricity Industry Participation Code Amendment (Shortened Gate Closure and Revised Bid and Offer Provisions) 2017.

Clause 13.34(1): amended, on 1 November 2022, by clause 21(2) of the Electricity Industry Participation Code Amendment (Real Time Pricing) 2022.

Clause 13.34(1)(c): amended, on 5 October 2017, by clause 347 of the Electricity Industry Participation Code Amendment (Code Review Programme) 2017.

Clause 13.34(2): amended, on 1 November 2018, by clause 83 of the Electricity Industry Participation Code Amendment (Code Review Programme) 2018.

Clause 13.34(3) and (4): revoked, on 29 June 2017, by clause 25(3) of the Electricity Industry Participation Code Amendment (Shortened Gate Closure and Revised Bid and Offer Provisions) 2017.

13.35 System operator to confirm receipt of grid owner information

- (1) *[Revoked]*
- (2) The **system operator** must immediately confirm to each **grid owner** receipt of all information received from that **grid owner** under clauses 13.29 to 13.35. The confirmation must also contain a record of the time of receipt.
- (3) If a **grid owner** has not received a confirmation that its information has been received by the **system operator** within 10 minutes after that information has been sent, the **grid owner** must telephone the **system operator** to check whether the information has been received. If it has not, the **grid owner** must resend the information. The process set out in this clause must be repeated until the **system operator** confirms receipt of the information.

Compare: Electricity Governance Rules 2003 rules 5.10 to 5.12 section II part G

Clause 13.35 Heading: amended, on 5 October 2017, by clause 348(1) of the Electricity Industry Participation Code Amendment (Code Review Programme) 2017.

Clause 13.35(1): revoked, on 5 October 2017, by clause 348(2)(a) of the Electricity Industry Participation Code Amendment (Code Review Programme) 2017.

Clause 13.35(2): amended, on 5 October 2017, by clause 348(2)(b) of the Electricity Industry Participation Code Amendment (Code Review Programme) 2017.

Clause 13.35(2): amended, on 1 November 2018, by clause 84 of the Electricity Industry Participation Code Amendment (Code Review Programme) 2018.

13.36 *[Revoked]*

Compare: Electricity Governance Rules 2003 rules 5.13 and 5.14 section II part G
Clause 13.36: revoked, on 5 October 2017, by clause 349 of the Electricity Industry Participation Code Amendment (Code Review Programme) 2017.

Offering instantaneous reserve

13.37 System operator to approve ancillary service agents wishing to make reserve offers

Before an **ancillary service agent** makes a **reserve offer** under clauses 13.38 to 13.54, the **ancillary service agent** must have a valid and enforceable contract with the **system operator** to provide **reserve offers** in accordance with this Code.

Compare: Electricity Governance Rules 2003 rule 6.1 section II part G

13.38 Ancillary service agents to submit reserve offers to system operator

- (1) Each **ancillary service agent** who has a contract described in clause 13.37 may submit **reserve offers** to the **system operator**.
- (1A) An **ancillary service agent** who submits a **reserve offer** must ensure that the **system operator** receives the **reserve offer** at least 71 **trading periods** before the beginning of the **trading period** to which the **reserve offer** applies.
- (2) Each **reserve offer** submitted by an **ancillary service agent** under subclause (1) may be for **fast instantaneous reserve**, **sustained instantaneous reserve** or both and must—
 - (a) contain all the information required by Form 5(1) in Schedule 13.1 for **partly loaded spinning reserve** or Form 5(2) in Schedule 13.1 for all other categories of **generation reserve**; and
 - (b) contain all the information required by Form 6 in Schedule 13.1 for **interruptible load**; and
 - (c) be a reasonable estimate of the quantity of **instantaneous reserve** available from the **ancillary service agent** at that **grid injection point**, **grid exit point** or **interruptible load group GXP**.
- (3) Each **reserve offer** submitted under subclause (1), by an **ancillary service agent** that is a **generator**, must be made by reference to the same **generating unit** or **generating station** that is the subject of an **offer** under clauses 13.10 or 13.11.

Compare: Electricity Governance Rules 2003 rules 6.2 to 6.4 section II part G

Clause 13.38(1): substituted, on 28 June 2012, by clause 25 of the Electricity Industry Participation (Demand-side Bidding and Forecasting) Code Amendment 2011.

Clause 13.38(1A): inserted, on 28 June 2012, by clause 25 of the Electricity Industry Participation (Demand-side Bidding and Forecasting) Code Amendment 2011.

Clause 13.38(1A): amended, on 1 November 2012, by clause 5 of the Electricity Industry Participation (Part 13 Minor Amendments) Code Amendment 2012.

Clause 13.38(2)(a): amended, on 3 May 2022, by clause 5 of the Electricity Industry Participation Code Amendment (Enabling Energy Storage Systems to Offer Instantaneous Reserve) 2022.

Clause 13.38(3): amended, on 15 May 2014, by clause 38 of the Electricity Industry Participation (Minor Code Amendments) Code Amendment 2014.

13.39 Inter-relationship between reserve and energy offers

Reserve offers and **offers** made under clauses 13.38(1) and 13.6(1) to (3) respectively, if they are in respect of the same individual **generating unit** or individual **generating station** (as required under clauses 13.10 and 13.11), are inter-related in that the greater the energy **dispatched** the lower the **instantaneous reserve** may be and vice versa. Accordingly, an **ancillary service agent** that is a **generator** does not breach clause 13.38(2)(c) if the **offer** quantity under clauses 13.6 to 13.27 and quantity of **instantaneous reserve** offered under clauses 13.37 to 13.54 are duplicated, and the **ancillary service agent** must not be scheduled by the **system operator** and a **dispatch instruction** from the **system operator** must not be given the effect of which is that the combined dispatch quantity and **instantaneous reserve** exceeds the capacity of the individual **generating unit** or individual **generating station**, as the case may be.

Compare: Electricity Governance Rules 2003 rule 6.5 section II part G

Clause 13.39: amended, on 15 May 2014, by clause 39 of the Electricity Industry Participation (Minor Code Amendments) Code Amendment 2014.

Clause 13.39: amended, on 20 December 2021, by clause 56 of the Electricity Industry Participation Code Amendment (Code Review Programme) 2019.

13.40 Inter-relationship between reserve offers of interruptible load and bids

Bids and **reserve offers of interruptible load** are inter-related in that **demand electrically disconnected** in response to an **under-frequency event** and in accordance with a dispatched **reserve offer** may lower the quantity purchased at that **grid exit point**. Accordingly, a **purchaser** does not breach the reasonable estimate requirement in clauses 13.7(3), 13.7AA(2), and 13.8A(4) if the **purchaser** is acting as an **ancillary service agent** and reduces corresponding **demand** in response to an **under-frequency event** in accordance with a dispatched **reserve offer**.

Compare: Electricity Governance Rules 2003 rule 6.6 section II part G

Clause 13.40 Heading: amended, on 15 May 2014, by clause 16(a) of the Electricity Industry Participation (Modified Dispatchable Demand) Code Amendment 2013.

Clause 13.40: amended, on 28 June 2012, by clause 26 of the Electricity Industry Participation (Demand-side Bidding and Forecasting) Code Amendment 2011.

Clause 13.40: amended, on 15 May 2014, by clause 16(b) of the Electricity Industry Participation (Modified Dispatchable Demand) Code Amendment 2013.

Clause 13.40: amended, on 5 October 2017, by clause 350 of the Electricity Industry Participation Code Amendment (Code Review Programme) 2017.

Clause 13.40: amended, on 20 December 2021, by clause 57 of the Electricity Industry Participation Code Amendment (Code Review Programme) 2019.

Clause 13.40: amended, on 3 May 2022, by clause 6 of the Electricity Industry Participation Code Amendment (Enabling Energy Storage Systems to Offer Instantaneous Reserve) 2022.

13.40A Inter-relationship between reserve offers and nominated dispatch bids

Reserve offers and **nominated dispatch bids** made under clauses 13.38(1) and 13.7(1) to (3) respectively, if they are in respect of the same plant, are inter-related in that the lower the **demand dispatched** or **scheduled** the lower the **instantaneous reserve** may be. The **ancillary service agent** must not be **scheduled** by the **system operator** and a **dispatch instruction** from the **system operator** must not be given the effect of which is that the **instantaneous reserve** exceeds the **scheduled** or **dispatched demand** quantity of the **dispatch-capable load station**, as the case may be.

Clause 13.40A: inserted, on 1 November 2022, by clause 22 of the Electricity Industry Participation Code Amendment (Real Time Pricing) 2022.

13.41 Reserve offers may contain up to 3 price bands

Each **reserve offer** submitted by an **ancillary service agent** may, for each type of **instantaneous reserve**, have a maximum of 3 price bands for each **trading period**. The price offered in each band must increase progressively from band to band as the aggregate quantity increases.

Compare: Electricity Governance Rules 2003 rule 6.7 section II part G

13.42 How price to be specified in reserve offers

When submitting a **reserve offer** under clause 13.38, an **ancillary service agent**—

- (a) must express the price in each band in dollars and whole cents per **MW** excluding **GST**; and
- (b) must specify a price that is equal to or greater than **\$0.00/MW**.

Compare: Electricity Governance Rules 2003 rule 6.8 section II part G

Clause 13.42: substituted, on 1 November 2012, by clause 6 of the Electricity Industry Participation (Part 13 Minor Amendments) Code Amendment 2012.

13.43 *[Revoked]*

Compare: Electricity Governance Rules 2003 rule 6.9 section II part G

Clause 13.43: revoked, on 1 November 2012, by clause 7 of the Electricity Industry Participation (Part 13 Minor Amendments) Code Amendment 2012.

13.44 How quantity is to be specified in reserve offers

- (1) For each price band, a **reserve offer** must specify the quantity of **instantaneous reserve** offered to respond as **fast instantaneous reserve** and/or **sustained instantaneous reserve**—
 - (a) as the generation available to be injected as a proportion of **electricity** output up to a specified maximum quantity for **partly loaded spinning reserve**; or
 - (b) as the generation available to be injected for all other categories of **generation reserve**; or
 - (c) as the **demand** available to be reduced for **interruptible load**.
- (2) The quantity that may be offered in a price band for a **trading period** must be expressed in **MW** to not more than 3 decimal places and must not be less than **0.000 MW**.

Compare: Electricity Governance Rules 2003 rule 6.10 section II part G

Clause 13.44: amended, on 15 May 2014, by clause 40 of the Electricity Industry Participation (Minor Code Amendments) Code Amendment 2014.

Clause 13.44: amended, on 29 June 2017, by clause 26 of the Electricity Industry Participation Code Amendment (Shortened Gate Closure and Revised Bid and Offer Provisions) 2017.

Clause 13.44: amended, on 3 May 2022, by clause 7 of the Electricity Industry Participation Code Amendment (Enabling Energy Storage Systems to Offer Instantaneous Reserve) 2022.

13.45 Reserve offers revised if energy offers revised

An **ancillary service agent** that has made a **reserve offer** must revise the **reserve offer** if it has, in accordance with clauses 13.6 to 13.27, revised the **offer** made in respect of the equivalent item of **generating plant**.

Compare: Electricity Governance Rules 2003 rule 6.11 section II part G

Clause 13.45: amended, on 29 June 2017, by clause 27 of the Electricity Industry Participation Code Amendment (Shortened Gate Closure and Revised Bid and Offer Provisions) 2017.

13.46 Reserve offer may be revised

- (1) Subject to subclauses (1A) and (1B), an **ancillary service agent** may revise a **reserve offer** at any time before the end of the **trading period** in respect of which the **reserve offer** is made by submitting a new **reserve offer** to the **system operator**.
- (1A) An **ancillary service agent** must not revise its **reserve offer** prices during a **gate closure period**.
- (1B) An **ancillary service agent** must not revise the **MW** specified in any price band in a **reserve offer** during a **gate closure period** unless subclause (3) or clause 13.47 applies.
- (2) An **ancillary service agent** that revises a **reserve offer** for an **embedded generating station** must use reasonable endeavours to submit the **reserve offer** at least 1 hour before the beginning of the **trading period** in respect of which the **reserve offer** is made.
- (3) Before the end of the **trading period** to which the **reserve offer** applies, and despite clauses 13.97 to 13.101, an **ancillary service agent** must immediately submit a revised **reserve offer** in respect of **MW** offered to the **system operator** if—
 - (a) the **MW** specified in any price band in the **reserve offer** no longer represents a reasonable estimate of the **instantaneous reserve** available from the **ancillary service agent** at the **grid injection point**, **grid exit point** or **interruptible load group GXP**
 - (b) *[Revoked]*
- (4) *[Revoked]*

Compare: Electricity Governance Rules 2003 rules 6.12 and 6.13 section II part G

Clause 13.46 Heading: amended, on 29 June 2017, by clause 28(1) of the Electricity Industry Participation Code Amendment (Shortened Gate Closure and Revised Bid and Offer Provisions) 2017.

Clause 13.46 Heading: amended, by clause 23(1) of the Electricity Industry Participation Code Amendment (Real Time Pricing) 2022.

Clause 13.46(1): replaced, on 29 June 2017, by clause 28(2) of the Electricity Industry Participation Code Amendment (Shortened Gate Closure and Revised Bid and Offer Provisions) 2017.

Clause 13.46(1) and (3): amended, by clause 23(2) of the Electricity Industry Participation Code Amendment (Real Time Pricing) 2022.

Clause 13.46(1A) and (1B): inserted, on 29 June 2017, by clause 28(2) of the Electricity Industry Participation Code Amendment (Shortened Gate Closure and Revised Bid and Offer Provisions) 2017.

Clause 13.46(2): replaced, on 29 June 2017, by clause 28(3) of the Electricity Industry Participation Code Amendment (Shortened Gate Closure and Revised Bid and Offer Provisions) 2017.

Clause 13.46(3): amended, on 29 June 2017, by clause 28(4)(a) and (b) of the Electricity Industry Participation Code Amendment (Shortened Gate Closure and Revised Bid and Offer Provisions) 2017.

Clause 13.46(3)(a): amended, on 29 June 2017, by clause 28(4)(c) of the Electricity Industry Participation Code Amendment (Shortened Gate Closure and Revised Bid and Offer Provisions) 2017.

Clause 13.46(3)(a): amended, by clause 23(3) of the Electricity Industry Participation Code Amendment (Real Time Pricing) 2022.

Clause 13.46(3)(b): amended, on 28 June 2012, by clause 27 of the Electricity Industry Participation (Demand-side Bidding and Forecasting) Code Amendment 2011.

Clause 13.46(3)(b): amended, on 29 June 2017, by clause 28(4)(d)(i) and (ii) of the Electricity Industry Participation Code Amendment (Shortened Gate Closure and Revised Bid and Offer Provisions) 2017.

Clause 13.46(3)(b): revoked, by clause 23(4) of the Electricity Industry Participation Code Amendment (Real Time Pricing) 2022.

Clause 13.46(4): revoked, on 29 June 2017, by clause 28(5) of the Electricity Industry Participation Code Amendment (Shortened Gate Closure and Revised Bid and Offer Provisions) 2017.

13.47 MW change during gate closure period

- (1) An **ancillary service agent** may revise a **reserve offer** during a **gate closure period** if—

- (a) the revision is necessary due to a **bona fide physical reason**; or
 - (b) the **system operator** issues a **formal notice** under clause 5 of **Technical Code B** of Schedule 8.3; or
 - (c) a **bona fide physical reason** that made a revision necessary under paragraph (a) ceases to exist sooner than was expected at the time it arose, and—
 - (i) the 1st **trading period** after the original **bona fide physical reason** ceases to exist is within 24 hours after the circumstances that constituted the original **bona fide physical reason** arose; and
 - (ii) the total change in **MW** specified in the **reserve offer** that is revised as a result of the **bona fide physical reason** ceasing to exist is the same or less than the total change in **MW** specified in the **reserve offer** that was made as a result of the original **bona fide physical reason**.
- (2) *[Revoked]*
- Compare: Electricity Governance Rules 2003 rule 6.14 section II part G
Clause 13.47 Heading: replaced, on 29 June 2017, by clause 29(1) of the Electricity Industry Participation Code Amendment (Shortened Gate Closure and Revised Bid and Offer Provisions) 2017.
Clause 13.47(1): replaced, on 29 June 2017, by clause 29(2) of the Electricity Industry Participation Code Amendment (Shortened Gate Closure and Revised Bid and Offer Provisions) 2017.
Clause 13.47(2): amended, on 15 May 2014, by clause 41 of the Electricity Industry Participation (Minor Code Amendments) Code Amendment 2014.
Clause 13.47(2): revoked, on 29 June 2017, by clause 29(3) of the Electricity Industry Participation Code Amendment (Shortened Gate Closure and Revised Bid and Offer Provisions) 2017.

13.48 System operator advised of revised reserve offers in certain circumstances

- (1) This clause applies to each **ancillary service agent** that submits a revised **reserve offer** in the period beginning 15 minutes before the **trading period** to which the revised **reserve offer** relates and ending at the end of the relevant **trading period**.
- (2) The **ancillary service agent** must immediately advise the **system operator** of the revision.

Compare: Electricity Governance Rules 2003 rule 6.15 section II part G
Clause 13.48 Heading: amended, on 5 October 2017, by clause 351(1) of the Electricity Industry Participation Code Amendment (Code Review Programme) 2017.
Clause 13.48: substituted, on 29 June 2017, by clause 30 of the Electricity Industry Participation Code Amendment (Shortened Gate Closure and Revised Bid and Offer Provisions) 2017.
Clause 13.48(1): amended, by clause 24 of the Electricity Industry Participation Code Amendment (Real Time Pricing) 2022.
Clause 13.48(2): amended, on 5 October 2017, by clause 351(2) of the Electricity Industry Participation Code Amendment (Code Review Programme) 2017

13.49 Authority advised of revised reserve offer during gate closure period

- (1) An **ancillary service agent** that submits a revised **reserve offer** to the **system operator** during a **gate closure period** must report each revision to the **Authority** in writing together with an explanation of the reason for the revision.
- (2) The **ancillary service agent** must report a revision to the **Authority** no later than 1700 hours on the 1st **business day** following the **trading day** on which it made the revision.

Compare: Electricity Governance Rules 2003 rule 6.16 section II part G
Clause 13.49 Heading: amended, on 5 October 2017, by clause 352 of the Electricity Industry Participation Code Amendment (Code Review Programme) 2017.
Clause 13.49: substituted, on 29 June 2017, by clause 31 of the Electricity Industry Participation Code Amendment (Shortened Gate Closure and Revised Bid and Offer Provisions) 2017.

13.50 System operator to advise Authority of revision of reserve offers

- (1) The **system operator** must advise the **Authority** of any revision of the availability of reserves that are provided under **ancillary services** contracts not covered by clauses 13.37 to 13.54.
- (1A) The **system operator** must advise the **Authority** of a revision no later than 1700 hours on the 1st **business day** following the **trading day** on which the revision was made.
- (2) *[Revoked]*

Compare: Electricity Governance Rules 2003 rules 6.17 and 6.18 section II part G

Clause 13.50 Heading: amended, on 29 June 2017, by clause 32(1) of the Electricity Industry Participation Code Amendment (Shortened Gate Closure and Revised Bid and Offer Provisions) 2017.

Clause 13.50(1): amended, on 29 June 2017, by clause 32(2)(a) and (b) of the Electricity Industry Participation Code Amendment (Shortened Gate Closure and Revised Bid and Offer Provisions) 2017.

Clause 13.50(1A): inserted, on 29 June 2017, by clause 32(3) of the Electricity Industry Participation Code Amendment (Shortened Gate Closure and Revised Bid and Offer Provisions) 2017.

Clause 13.50(2): revoked, on 29 June 2017, by clause 32(4) of the Electricity Industry Participation Code Amendment (Shortened Gate Closure and Revised Bid and Offer Provisions) 2017.

13.51 Transmission of reserve offers

- (1) All **reserve offers** or cancellations of **reserve offers** submitted by an **ancillary service agent** under clauses 13.37 to 13.54 must be transmitted to the **system operator** through **WITS**.
- (2) The **system operator** must immediately confirm receipt to the **ancillary service agent** of all **reserve offers** or cancellations of **reserve offers** received from the **ancillary service agent** through **WITS**. Such confirmation must also contain a copy of the **reserve offer** or cancellation of **reserve offer** received by the **system operator**, together with the time of receipt.
- (3) If an **ancillary service agent** has not received confirmation that the **system operator** has received its **reserve offer** or cancellation of a **reserve offer** within 10 minutes after the **ancillary service agent** submitted the **reserve offer** or cancellation of a **reserve offer**, the **ancillary service agent** must check whether the **system operator** has received the **reserve offer** or cancellation of a **reserve offer**. If the **system operator** has not received the **reserve offer** or cancellation of a **reserve offer**, the **ancillary service agent** must resend the **reserve offer** or cancellation of a **reserve offer**. The processes set out in this clause must then be repeated until the **system operator** confirms receipt of the **reserve offer** or cancellation of a **reserve offer** from the **ancillary service agent**.

Compare: Electricity Governance Rules 2003 rules 6.19 to 6.21 section II part G

Clause 13.51 Heading: amended, on 5 October 2017, by clause 353(1) of the Electricity Industry Participation Code Amendment (Code Review Programme) 2017.

Clause 13.51(1) and (2): amended, on 5 October 2017, by clause 353(2)(a) of the Electricity Industry Participation Code Amendment (Code Review Programme) 2017.

Clause 13.51(3): replaced, on 5 October 2017, by clause 351(2)(b) of the Electricity Industry Participation Code Amendment (Code Review Programme) 2017.

13.52 Backup procedures if WITS is unavailable

- (1) If **WITS** is unavailable to receive **reserve offers** or cancellations of **reserve offers** or to confirm the receipt of such **reserve offers** or cancellations, an **ancillary service agent** or the **system operator**, as the case may be, must follow the backup procedures specified by the **WITS manager**.

- (2) The backup procedures referred to in subclause (1) must be specified by the **WITS manager** following consultation with the **Authority, ancillary service agents** and the **system operator**.

Compare: Electricity Governance Rules 2003 rules 6.22 and 6.23 section II part G

Clause 13.52 Heading: amended, on 5 October 2017, by clause 354(1) of the Electricity Industry Participation Code Amendment (Code Review Programme) 2017.

Clause 13.52: amended, on 5 October 2017, by clause 354(2), (3) and (4) of the Electricity Industry Participation Code Amendment (Code Review Programme) 2017.

13.53 Additional information to be provided by participants

Despite clauses 13.22, 13.23, 13.51, and 13.52, if an **ancillary service agent** submits a **reserve offer** for **generation reserve** in accordance with clauses 13.37 to 13.54, the **ancillary service agent** must also provide the maximum quantity of fast response **generation reserve** expressed in **MW** and/or the maximum quantity of sustained response **generation reserve** expressed in **MW** to the **system operator** in a manner and at such times as are approved by the **system operator** (such approval not to be unreasonably withheld).

Compare: Electricity Governance Rules 2003 rule 6.24 section II part G

Clause 13.53: amended, on 15 May 2014, by clause 42 of the Electricity Industry Participation (Minor Code Amendments) Code Amendment 2014.

Clause 13.53: amended, on 3 May 2022, by clause 8 of the Electricity Industry Participation Code Amendment (Enabling Energy Storage Systems to Offer Instantaneous Reserve) 2022.

13.54 System operator to retain reserve offers

The **system operator** must retain, in a form that it considers appropriate, all **reserve offers** submitted by all **ancillary service agents** in accordance with this subpart, including all revised **reserve offers**.

Compare: Electricity Governance Rules 2003 rule 6.25 section II part G

Clause 13.54: amended, on 29 June 2017, by clause 33 of the Electricity Industry Participation Code Amendment (Shortened Gate Closure and Revised Bid and Offer Provisions) 2017.

13.55 Availability of bids, offers, and reserve offers

- (1) The **WITS manager** must, within 24 hours of the end of each day, make available on **WITS** and at no cost on a publicly accessible **approved system**, all final **bids**, final **offers** and final **reserve offers** received for the **trading periods** of the previous **trading day**.
- (2) All information made available on **WITS** and on the publicly accessible **approved system** must remain available for inspection for a period of at least 4 weeks—
 - (a) on **WITS**; and
 - (b) at no cost on the publicly accessible **approved system**.
- (3) If **WITS** is unavailable for the purposes of subclause (2)(a), the **WITS manager** must follow the backup procedures specified by the **WITS manager** from time to time.
- (4) The backup procedures referred to in subclause (3) must be put in place by the **WITS manager** in consultation with the **Authority, purchasers, generators** and **ancillary service agents**.
- (5) If the publicly accessible **approved system** is not available for the purposes of subclause (2)(b), the **WITS manager** is not obliged to follow any backup procedures,

but the **WITS manager** must make the information available at no cost as soon as practicable once the publicly accessible **approved system** becomes available.

(6) *[Revoked]*

(7) *[Revoked]*

Compare: Electricity Governance Rules 2003 rule 7 section II part G

Clause 13.55 Heading: amended, on 28 June 2012, by clause 28(1) of the Electricity Industry Participation (Demand-side Bidding and Forecasting) Code Amendment 2011.

Clause 13.55(1): amended, on 5 October 2017, by clause 355(1) and (2) of the Electricity Industry Participation Code Amendment (Code Review Programme) 2017.

Clause 13.55(2): replaced, on 5 October 2017, by clause 355(3) of the Electricity Industry Participation Code Amendment (Code Review Programme) 2017.

Clause 13.55(3): amended, on 5 October 2017, by clause 355(1) and (4) of the Electricity Industry Participation Code Amendment (Code Review Programme) 2017.

Clause 13.55(4): amended, on 5 October 2017, by clause 355(1) and (5) of the Electricity Industry Participation Code Amendment (Code Review Programme) 2017.

Clause 13.55(5): replaced, on 5 October 2017, by clause 355(6) of the Electricity Industry Participation Code Amendment (Code Review Programme) 2017.

Clause 13.55(6) and (7): revoked, on 28 June 2012, by clause 28(2) of the Electricity Industry Participation (Demand-side Bidding and Forecasting) Code Amendment 2011.

13.55A System operator to make information available

- (1) The **system operator** must retain, for at least 2 years,—
 - (a) information about all **bids**, cancelled **bids**, **offers**, cancelled **offers**, **reserve offers**, and cancelled **reserve offers** submitted by a **purchaser**, **generator**, or **ancillary service agent** for a **trading period**; and
 - (b) each forecast prepared under clause 13.7A(1).
- (2) Any person may request that the **system operator** make available any of the information described in subclause (1) for any **trading period** that occurred at least 1 day before the date of the request.
- (3) The **system operator** must make the requested information available in a manner, and for a fee, that is reasonable having regard to the size and nature of the request.

Clause 13.55A: inserted, on 28 June 2012, by clause 29 of the Electricity Industry Participation (Demand-side Bidding and Forecasting) Code Amendment 2011.

Clause 13.55A(1)(b): amended, on 15 May 2014, by clause 17 of the Electricity Industry Participation (Modified Dispatchable Demand) Code Amendment 2013.

Subpart 2—Scheduling and dispatch

13.56 Contents of this subpart

This subpart specifies—

- (a) the **system operator's dispatch objective**; and
- (b) the process for preparing a **price-responsive schedule** and **non-response schedule**, including the contents of and inputs for those schedules; and
- (c) the process by which the **system operator** prepares a **dispatch schedule**; and
- (d) the process by which the **system operator** prepares and issues **dispatch instructions** and **dispatch notifications**; and
- (e) the requirement for **generators**, **ancillary service agents**, and **dispatched purchasers** to comply with **dispatch instructions**; and
- (f) *[Revoked]*
- (g) the implications of a **grid emergency** for **bids**, **offers** and **reserve offers**; and

- (h) the **system operator's** reporting obligations; and
- (i) the requirement for the **system operator** to **publish** scheduling information.

Compare: Electricity Governance Rules 2003 rule 1 section III part G

Clause 13.56: substituted, on 28 June 2012, by clause 30 of the Electricity Industry Participation (Demand-side Bidding and Forecasting) Code Amendment 2011.

Clause 13.56(d): amended, by clause 25(1) of the Electricity Industry Participation Code Amendment (Real Time Pricing) 2022.

Clause 13.56(e): amended, on 15 May 2014, by clause 18 of the Electricity Industry Participation (Modified Dispatchable Demand) Code Amendment 2013.

Clause 13.56(f): revoked, by clause 25(2) of the Electricity Industry Participation Code Amendment (Real Time Pricing) 2022.

13.57 The dispatch objective

The **system operator's dispatch objective** is to maximise for each **half hour** the gross economic benefits to all **purchasers** of **electricity** at the **grid exit points**, less the cost of supplying the **electricity** at the **grid injection points** and the costs of **ancillary services** purchased by the **system operator** under subpart 3 of Part 8, in accordance with the methodology set out in Schedule 13.3, subject to—

- (a) the capability of generation, **dispatch-capable load stations** for which a **nominated dispatch bid** was submitted, and **ancillary services** and the configuration and capacity of the **grid** and information made available by **asset owners**; and
- (b) achieving the **principal performance obligations** and any arrangements of the type described in clause 8.6; and
- (c) meeting the requirements of clause 8.5 in relation to restoration of the power system—

provided that in the case of any conflict between paragraphs (b) and (c), paragraph (c) takes priority.

Compare: Electricity Governance Rules 2003 rule 2 section III part G

Clause 13.57(a): amended, on 15 May 2014, by clause 19 of the Electricity Industry Participation (Modified Dispatchable Demand) Code Amendment 2013.

13.58 Process for preparing price-responsive schedule and non-response schedule

- (1) The **system operator** must prepare—
 - (a) a **price-responsive schedule**; and
 - (b) a **non-response schedule**.
- (1A) The **system operator** must prepare the schedules listed in subclause (1) in accordance with the timing required under clause 13.62.
- (2) *[Revoked]*
- (3) *[Revoked]*
- (3A) In preparing each **price-responsive schedule**, the **system operator** must—
 - (a) use the most recent information received under subpart 1; and
 - (b) use all other information described in clause 13.58A(1); and
 - (c) act in accordance with Schedule 13.3.
- (3B) In preparing each **non-response schedule**, the **system operator** must—
 - (a) use the most recent information received under subpart 1; and
 - (b) use all other information described in clause 13.58A(2); and
 - (c) act in accordance with Schedule 13.3.

- (4) As soon as practicable after the **system operator** has completed preparing a **price-responsive schedule** and a **non-response schedule**, the **system operator** must make the schedules available to the **clearing manager** using **WITS**.

Compare: Electricity Governance Rules 2003 rules 3.1 to 3.4 section III part G

Clause 13.58(1): substituted, on 28 June 2012, by clause 31 of the Electricity Industry Participation (Demand-side Bidding and Forecasting) Code Amendment 2011.

Clause 13.58(1A): inserted, on 28 June 2012, by clause 31 of the Electricity Industry Participation (Demand-side Bidding and Forecasting) Code Amendment 2011.

Clause 13.58(2) and (3): revoked, on 28 June 2012, by clause 31 of the Electricity Industry Participation (Demand-side Bidding and Forecasting) Code Amendment 2011.

Clause 13.58(3A) and (3B): inserted, on 28 June 2012, by clause 31 of the Electricity Industry Participation (Demand-side Bidding and Forecasting) Code Amendment 2011.

Clause 13.58(4): substituted, on 28 June 2012, by clause 31 of the Electricity Industry Participation (Demand-side Bidding and Forecasting) Code Amendment 2011.

Clause 13.58(4): amended, on 5 October 2017, by clause 356 of the Electricity Industry Participation Code Amendment (Code Review Programme) 2017.

13.58AA System operator to assign price and quantity values

- (1) In preparing each **price-responsive schedule** and each **non-response schedule**, the **system operator** must assign the price and quantity values set out in subclause (2) to the following **demand**:
- (a) in relation to a **price-responsive schedule**, forecast **demand** at a **conforming GXP** that is not the subject of a **bid**;
 - (b) in relation to a **non-response schedule**,—
 - (i) forecast **demand** at a **conforming GXP** that is not the subject of a **nominated bid**; and
 - (ii) **demand** at a **GXP** that is the subject of a **nominated non-dispatch bid**.
- (2) The price and quantity values are as follows:
- (a) \$10,000 per **MWh** for the first 5% of the relevant **demand**;
 - (b) \$15,000 per **MWh** for the next 15% of the relevant **demand**;
 - (c) \$20,000 per **MWh** for the remaining 80% of the relevant **demand**.
- (3) In preparing each **price-responsive schedule** and each **non-response schedule**, the **system operator** must assign the price and quantity values set out in the following table to the constraints specified in clause 12(5) of Schedule 13.3:

Tranche	Fast instantaneous reserve contingent risk violation (\$/MWh)	Sustained instantaneous reserve contingent risk violation (\$/MWh)	Quantity (MWh)
1	3,500	3,000	50
2	4,000	3,500	100
3	4,500	4,000	No limit

- (4) In preparing each **price-responsive schedule** and each **non-response schedule**, the **system operator** must assign the price values set out in the following table to the model parameters specified in clause 1 of Schedule 13.2:

Tranche	6 second contingent risk violation (\$/MWh)	60 second contingent risk violation (\$/MWh)	Quantity (MWh)
1	3,500	3,000	50
2	4,000	3,500	100
3	4,500	4,000	No limit

Clause 13.58(AA): inserted, by clause 26 of the Electricity Industry Participation Code Amendment (Real Time Pricing) 2022.

13.58AB Authority to review price and quantity values

The **Authority** may review the price and quantity values specified in clause 13.58AA(2) and (3) at any time, and must do so no later than 5 years after the commencement of this clause, and at intervals of no more than 5 years after that.

Clause 13.58(AB): inserted, by clause 26 of the Electricity Industry Participation Code Amendment (Real Time Pricing) 2022.

13.58A Inputs for price-responsive schedule and non-response schedule

- (1) The **system operator** must prepare a **price-responsive schedule** using the following inputs:
- (a) **offers and reserve offers**; and
 - (aa) the potential output of all **intermittent generating stations**, determined using the most recent **forecast of generation potential** for each **intermittent generating station** submitted under clause 13.18A; and
 - (b) **nominated bids**; and
 - (c) the forecast prepared by the **system operator** under clause 13.7A(1); and
 - (d) **difference bids**; and
 - (e) information provided to the **system operator** by a **grid owner** under clauses 13.29 to 13.34 about—
 - (i) the AC transmission system configuration, capacity, and **losses**; and
 - (ii) the capability of the **HVDC link** including the **HVDC link configuration**, the capacity of the **HVDC link**, the **losses** in the **HVDC link**, the direction of any transfer limit on the **HVDC link**, and any minimum or maximum transfer limits on the **HVDC link**; and
 - (iii) transformer configuration, capacity, and **losses**; and
 - (f) the adjustments specified in subclause (2)(e), subject to any exceptions specified in the **policy statement**; and
 - (g) information about **voltage support** from contracts held by the **system operator** under the **procurement plan**; and

- (h) information from **ancillary service agents** about **instantaneous reserves** procured under the **procurement plan**; and
 - (i) any price and quantity values assigned by the **system operator** under clause 13.58AA(1)(a).
- (2) The **system operator** must prepare a **non-response schedule** using the following inputs:
- (a) **offers, nominated dispatch bids, and reserve offers**; and
 - (aa) the potential output of all **intermittent generating stations**, determined using the most recent **forecast of generation potential** for each **intermittent generating station** submitted under clause 13.18A; and
 - (b) **nominated non-dispatch bid** quantities (where, in the case of a **nominated non-dispatch bid** submitted by a **dispatch notification purchaser**, the relevant quantity is 0 MW); and
 - (c) the forecast prepared by the **system operator** under clause 13.7A(1); and
 - (d) information provided to the **system operator** by a **grid owner** under clauses 13.29 to 13.34 referring to—
 - (i) the AC transmission system configuration, capacity, and **losses**; and
 - (ii) the capability of the **HVDC link** including the **HVDC link configuration**, the capacity of the **HVDC link**, the **losses** in the **HVDC link**, the direction of any transfer limit on the **HVDC link**, and any minimum or maximum transfer limits on the **HVDC link**; and
 - (iii) transformer configuration, capacity, and **losses**; and
 - (e) adjustments made by the **system operator** under clause 13(1) of Schedule 13.3, in order to meet the **dispatch objective**; and
 - (f) information about **voltage support** from contracts held by **the system operator** under the **procurement plan**; and
 - (g) information from **ancillary service agents** about **instantaneous reserves** procured under the **procurement plan**; and
 - (h) any price and quantity values assigned by the **system operator** under clause 13.58AA(1)(b).

Clause 13.58A: inserted, on 28 June 2012, by clause 32 of the Electricity Industry Participation (Demand-side Bidding and Forecasting) Code Amendment 2011.

Clause 13.58A(1)(aa): inserted, at 12.00 pm on 19 September 2019, by clause 16(1) of the Electricity Industry Participation Code Amendment (Wind Offer Arrangements) 2019.

Clause 13.58A(1)(c): amended, on 15 May 2014, by clause 20 of the Electricity Industry Participation (Modified Dispatchable Demand) Code Amendment 2013.

Clause 13.58A(1)(e)(ii): substituted, on 1 November 2012, by clause 5(1) of the Electricity Industry Participation (HVDC Link Pole 3 Standing Data) Code Amendment 2012.

Clause 13.58A(1)(h): amended, by clause 27(1) of the Electricity Industry Participation Code Amendment (Real Time Pricing) 2022.

Clause 13.58A(1)(i): inserted, by clause 27(2) of the Electricity Industry Participation Code Amendment (Real Time Pricing) 2022.

Clause 13.58A(2)(a) – (c): amended, on 15 May 2014, by clause 20 of the Electricity Industry Participation (Modified Dispatchable Demand) Code Amendment 2013.

Clause 13.58A(2)(aa): inserted, at 12.00 pm on 19 September 2019, by clause 16(2) of the Electricity Industry Participation Code Amendment (Wind Offer Arrangements) 2019.

Clause 13.58A(2)(b): amended, by clause 27(3) of the Electricity Industry Participation Code Amendment (Real Time Pricing) 2022.

Clause 13.58A(2)(d)(ii): substituted, on 1 November 2012, by clause 5(2) of the Electricity Industry Participation (HVDC Link Pole 3 Standing Data) Code Amendment 2012.

Clause 13.58A(2)(g): amended, by clause 27(4) of the Electricity Industry Participation Code Amendment (Real Time Pricing) 2022.

Clause 13.58A(2)(h): inserted, by clause 27(5) of the Electricity Industry Participation Code Amendment (Real Time Pricing) 2022.

Clause 13.58A(1)(e)(ii): replaced, on 1 March 2024, by clause 72(1) of the Electricity Industry Participation Code Amendment (Code Review Programme) 2024.

Clause 13.58A(2)(d)(ii): replaced, on 1 March 2024, by clause 72(2) of the Electricity Industry Participation Code Amendment (Code Review Programme) 2024.

13.59 Contents of each price-responsive schedule and non-response schedule

For each **trading period** in the **schedule length period**, each **price-responsive schedule** and each **non-response schedule** prepared by the **system operator** must contain the information specified in the table in Schedule 13.3B, as indicated by a X—

- (a) in the case of the **price-responsive schedule**, in column 1 of the table; and
- (b) in the case of the **non-response schedule**, in column 2 of the table.

Compare: Electricity Governance Rules 2003 rule 3.5 section III part G

Clause 13.59: substituted, on 28 June 2012, by clause 33 of the Electricity Industry Participation (Demand-side Bidding and Forecasting) Code Amendment 2011.

Clause 13.59(a)(iv): amended, on 3 October 2013, by clause 5 of the Electricity Industry Participation (Technology Neutral Language in Frequency Keeping) Code Amendment 2013.

Clause 13.59(a)(xviii) and (xix): inserted, on 1 June 2013, by clause 6 of the Electricity Industry Participation (Scarcity Pricing) Code Amendment 2011.

Clause 13.59(c): substituted, on 15 May 2014, by clause 21 of the Electricity Industry Participation (Modified Dispatchable Demand) Code Amendment 2013.

Clause 13.59: replaced, by clause 28 of the Electricity Industry Participation Code Amendment (Real Time Pricing) 2022.

13.60 Block dispatch may occur

- (1) A **generator** and the **system operator** may agree to treat a group of **generating stations** as a **block dispatch group**.
- (2) If an agreement for block dispatch has been reached, the following procedures apply:
 - (a) the **generator** must give written notice to the **clearing manager** of the agreement, at least **5 business days** before the agreement takes effect, specifying—
 - (i) the **trading day** and the **trading period** in which the agreement will take effect; and
 - (ii) the **generating stations** that are the subject of the agreement; and
 - (iii) the terms of the agreement; and
 - (b) the **system operator** must identify in each **non-response schedule** the **generating stations** or **generating units** that are part of a **block dispatch group**.
- (3) The **generator** must give written notice to the **clearing manager** of any change to an agreement for block dispatch made under this clause or clause 13.61 at least **5 business days** before the change takes effect.

Compare: Electricity Governance Rules 2003 rules 3.6 to 3.6.2 section III part G

Clause 13.60(2)(a) and (3): amended, on 5 October 2017, by clause 357 of the Electricity Industry Participation Code Amendment (Code Review Programme) 2017.

Clause 13.60(2)(a): amended, on 1 November 2018, by clause 85(1) of the Electricity Industry Participation Code Amendment (Code Review Programme) 2018.

Clause 13.60(2)(b): amended, on 28 June 2012, by clause 34 of the Electricity Industry Participation (Demand-side Bidding and Forecasting) Code Amendment 2011.

Clause 13.60(3): inserted, on 15 May 2014, by clause 43 of the Electricity Industry Participation (Minor Code Amendments) Code Amendment 2014.

Clause 13.60(3): amended, on 1 November 2018, by clause 85(2)(a) of the Electricity Industry Participation Code Amendment (Code Review Programme) 2018.

13.61 System operator to give notice of block security constraints

- (1) The **system operator** must give notice on **WITS** to **generators** of the implication of any **block security constraints** that apply within the **block dispatch group**. The notice must include—
 - (a) the **trading periods** for which the **block security constraint** applies; and
 - (b) how the **block security constraint** divides the **generating stations** or **generating units** of a **block dispatch group** into **sub-block dispatch groups**.
- (2) If a notice has been sent in accordance with subclause (1), the notice remains valid until the earliest of—
 - (a) completion of the **trading periods** set out in the notice; or
 - (b) receipt of another notice from the **system operator** in accordance with subclause (1) for the same **block dispatch group** for the same **trading period** or **trading periods**; or
 - (c) receipt of a notice from the **system operator** that the **block security constraint** no longer exists; or
 - (d) receipt of an instruction from the **system operator** in accordance with clause 13.75(1)(f) for the same **block dispatch group** for the applicable **trading period**, and such instruction remains valid for the **trading periods** specified in that instruction.

(3) *[Revoked]*

Compare: Electricity Governance Rules 2003 rules 3.6.3 to 3.6.5 section III part G

Clause 13.61 Heading: amended, on 5 October 2017, by clause 358(1) of the Electricity Industry Participation Code Amendment (Code Review Programme) 2017.

Clause 13.61(1): amended, on 5 October 2017, by clause 358(2) of the Electricity Industry Participation Code Amendment (Code Review Programme) 2017.

Clause 13.61(1)(a) and (b): amended, on 1 February 2016, by clause 79(1) and (2) of the Electricity Industry Participation Code Amendment (Code Review Programme) 2015.

Clause 13.61(2)(c): amended, on 1 February 2016, by clause 79(3) of the Electricity Industry Participation Code Amendment (Code Review Programme) 2015.

Clause 13.61(2)(c): amended, on 5 October 2017, by clause 358(3) of the Electricity Industry Participation Code Amendment (Code Review Programme) 2017.

Clause 13.61(2)(d): amended, on 1 November 2018, by clause 86 of the Electricity Industry Participation Code Amendment (Code Review Programme) 2018.

Clause 13.61(3): revoked, on 15 May 2014, by clause 44 of the Electricity Industry Participation (Minor Code Amendments) Code Amendment 2014.

13.62 Frequency of price-responsive schedules and non-response schedules

- (1) The **system operator** must use reasonable endeavours to commence preparing a **price-responsive schedule** and a **non-response schedule**—
 - (a) once in every 4th **trading period** throughout the **trading day**, for a period covering—
 - (i) the **trading period** in which the **system operator** commences preparing the relevant schedule; and
 - (ii) the following 71 **trading periods**; and
 - (b) once in each **trading period** for a period covering—
 - (i) the **trading period** in which the **system operator** commences preparing the relevant schedule; and
 - (ii) the following 7 **trading periods**.
- (2) The **system operator** must use reasonable endeavours to ensure that—

- (a) each time it prepares a **price-responsive schedule**, it prepares a **non-response schedule** at the same time; and
 - (b) each time it prepares a **non-response schedule**, it prepares a **price-responsive schedule** at the same time.
- (3) The **system operator** must complete a schedule—
- (a) if it commenced preparing the schedule under subclause (1)(a), by the end of the **trading period** after the **trading period** in which the **system operator** commenced preparing the schedule; and
 - (b) if it commenced preparing the schedule under subclause (1)(b), by the end of the **trading period** in which the **system operator** commenced preparing the schedule.

Compare: Electricity Governance Rules 2003 rule 3.7 section III part G
Clause 13.62: substituted, on 28 June 2012, by clause 35 of the Electricity Industry Participation (Demand-side Bidding and Forecasting) Code Amendment 2011.

13.63 Trading period information to be made available to clearing manager

The **system operator** must, by 0730 hours of each **trading day**, make the final information provided to the **system operator** under subpart 1 in relation to each **trading period** of the previous **trading day** available to the **clearing manager** on **WITS** or through an **approved system**.

Compare: Electricity Governance Rules 2003 rule 3.8 section III part G
Clause 13.63 Heading: amended, on 5 October 2017, by clause 359(1) of the Electricity Industry Participation Code Amendment (Code Review Programme) 2017.
Clause 13.63 Heading: amended, by clause 29(1) of the Electricity Industry Participation Code Amendment (Real Time Pricing) 2022.
Clause 13.63: amended, on 5 October 2017, by clause 359(2) of the Electricity Industry Participation Code Amendment (Code Review Programme) 2017.
Clause 13.63: amended, by clause 29(2) of the Electricity Industry Participation Code Amendment (Real Time Pricing) 2022

13.64 Station dispatch may occur

- (1) A **generator** may elect to have its **generating plant dispatched** as a **station dispatch group** by giving the **system operator** at least 15 **business days'** notice in writing in the form set out in Form 8 of Schedule 13.1. The **system operator** must use best endeavours to implement the election within 15 **business days** after receiving the notice.
- (2) The **system operator** must give written notice to the **generator** and the **clearing manager** of the effective date of the election at least 5 **business days** before the date. On and from the effective date, the procedures set out in clauses 13.65 and 13.66 must be followed by the **system operator** and the **generator**.

Compare: Electricity Governance Rules 2003 rule 3.9 section III part G
Clause 13.64(2): amended, on 5 October 2017, by clause 360 of the Electricity Industry Participation Code Amendment (Code Review Programme) 2017.

13.65 System operator to give notice of station security constraints

- (1) The **system operator** must give notice on **WITS** to the **generator** of the implication of any **station security constraints** that apply within a **station dispatch group**. The notice must include—
 - (a) the **trading periods** for which the **station security constraint** applies; and

- (b) how the **station security constraint** divides the **generating units** or **generating stations** of a **station dispatch group** into a **sub-station dispatch group** or limits the generation of a **station dispatch group**.
- (2) If a notice has been sent in accordance with subclause (1), the notice remains valid until the earliest of—
- (a) completion of the **trading periods** set out in the notice; or
 - (b) receipt of another notice from the **system operator** in accordance with subclause (1) for the same **station dispatch group** for the same **trading period** or **trading periods**; or
 - (c) receipt of a notice from the **system operator** that the **station security constraint** no longer exists; or
 - (d) receipt of an instruction from the **system operator** in accordance with clause 13.75(1)(g) for the same **station dispatch group** for the applicable **trading period**, and the instruction remains valid for the **trading periods** specified in the instruction.

Compare: Electricity Governance Rules 2003 rules 3.9.1 and 3.9.2 section III part G

Clause 13.65 Heading: amended, on 5 October 2017, by clause 361(1) of the Electricity Industry Participation Code Amendment (Code Review Programme) 2017.

Clause 13.65(1): amended, on 5 October 2017, by clause 361(2) of the Electricity Industry Participation Code Amendment (Code Review Programme) 2017.

Clause 13.65(2)(c): amended, on 5 October 2017, by clause 361(3) of the Electricity Industry Participation Code Amendment (Code Review Programme) 2017.

Clause 13.65(2)(d): amended, on 1 November 2018, by clause 87 of the Electricity Industry Participation Code Amendment (Code Review Programme) 2018.

13.66 Generator gives written notice of change from station to unit dispatch

If a **generator** changes the dispatch of its **generating plant** from a **station dispatch group** basis to a **generating unit** basis, it must give the **system operator** at least 15 **business days**’ notice in writing. The **system operator** must use best endeavours to implement the change within 15 **business days** of receiving a notice. The **system operator** must give written notice to the **generator** and the **clearing manager** of the effective date of the change at least 5 **business days** before the date.

Compare: Electricity Governance Rules 2003 rule 3.9.3 section III part G

Clause 13.66 Heading: amended, on 5 October 2017, by clause 362(1) of the Electricity Industry Participation Code Amendment (Code Review Programme) 2017.

Clause 13.66: amended, on 5 October 2017, by clause 362(2) of the Electricity Industry Participation Code Amendment (Code Review Programme) 2017.

13.67 Transmission of information

- (1) *[Revoked]*
- (2) If **WITS** or the publicly accessible **approved system** is unavailable for the purposes of making information available under clauses 13.58 to 13.66, the **system operator** must follow the backup procedures specified by the **WITS manager**.
- (3) The **WITS manager** must specify the backup procedures referred to in subclause (2) following consultation with the **Authority**, the **system operator** and the **clearing manager**.

Compare: Electricity Governance Rules 2003 rules 3.10 to 3.12 section III part G

Clause 13.67 Heading: amended, on 5 October 2017, by clause 363(1) of the Electricity Industry Participation Code Amendment (Code Review Programme) 2017.

Clause 13.67(1): revoked, on 5 October 2017, by clause 363(2)(a) of the Electricity Industry Participation Code Amendment (Code Review Programme) 2017.

Clause 13.67(2) and (3): replaced, on 5 October 2017, by clause 363(2)(b) of the Electricity Industry Participation Code Amendment (Code Review Programme) 2017.

Clause 13.67(3): amended, by clauses 30(a) and (b) of the Electricity Industry Participation Code Amendment (Real Time Pricing) 2022

The dispatch process

13.68 [Revoked]

Compare: Electricity Governance Rules 2003 rule 4.1 section III part G

Clause 13.68 Heading: amended, on 28 June 2012, by clause 36(1) of the Electricity Industry Participation (Demand-side Bidding and Forecasting) Code Amendment 2011.

Clause 13.68(1): amended, on 28 June 2012, by clause 36(2) of the Electricity Industry Participation (Demand-side Bidding and Forecasting) Code Amendment 2011.

Clause 13.68: revoked, on 15 May 2014, by clause 22 of the Electricity Industry Participation (Modified Dispatchable Demand) Code Amendment 2013.

13.69 [Revoked]

Compare: Electricity Governance Rules 2003 rule 4.2 section III part G

Clause 13.69: revoked, on 15 May 2014, by clause 22 of the Electricity Industry Participation (Modified Dispatchable Demand) Code Amendment 2013.

13.69A System operator to prepare dispatch schedule

- (1) Except as provided in clause 13.72A, before each **trading period**, or as soon as practicable after the start of a **trading period**, the **system operator** must prepare a **dispatch schedule** for the **trading period**—
 - (a) using the information described in clause 13.69B; and
 - (b) in accordance with the methodology set out in Schedule 13.3.
- (2) The **system operator** must prepare a new **dispatch schedule** for a **trading period** as frequently as the **system operator** considers is necessary during a **trading period** to meet the **dispatch objective**.

Clause 13.69A: inserted, on 15 May 2014, by clause 23 of the Electricity Industry Participation (Modified Dispatchable Demand) Code Amendment 2013.

Clause 13.69A: replaced, by clause 31 of the Electricity Industry Participation Code Amendment (Real Time Pricing) 2022

13.69AA System operator to assign price and quantity values

- (1) In preparing each **dispatch schedule**, the **system operator** must assign the price and quantity values—
 - (a) set out in clause 13.58AA(2) for the expected profile of **demand** under clause 13.69B(1)(d) for the demand at each **GXP** that is not the subject of a **nominated dispatch bid**; and
 - (b) set out in clause 13.58AA(3) to the constraints specified in clause 12(5) of Schedule 13.3; and
 - (c) set out in clause 13.58AA(4) to the model parameters specified in clause 1 of Schedule 13.2.
- (2) The prices and quantities assigned in subclause (1) must be used in the **dispatch schedule** in accordance with the processes set out in Schedule 13.3AA.

Clause 13.69AA: inserted, by clause 32 of the Electricity Industry Participation Code Amendment (Real Time Pricing) 2022.

13.69AAA Grid owner to provide real time demand values to system operator

- (1) Each **grid owner** must provide to the **system operator** real time net **demand** values (in **MW**) for each of its **GXPs** that are required by the **system operator** to calculate the expected profile of **demand** under clause 13.69B.
- (2) A **grid owner** must, to the extent practicable, source the information required under subclause (1) from its **grid** revenue meters.
Clause 13.69AAA: inserted, by clause 32 of the Electricity Industry Participation Code Amendment (Real Time Pricing) 2022.

13.69B Inputs for dispatch schedule

- (1) The **system operator** must use the following inputs to prepare a **dispatch schedule**:
 - (a) **offers** and **reserve offers**, excluding the following:
 - (i) **offers** submitted by an **intermittent generator** under clause 13.6:
 - (ii) revised **offers** submitted by an **intermittent generator** under clause 13.18A:
 - (iii) **offers** submitted by a **type B co-generator** under clause 13.6:
 - (iv) revised **offers** submitted by a **type B co-generator** under clause 13.17; and
 - (b) the quantities and prices specified in **nominated dispatch bids** (clause 13.7) and the quantities and prices specified in revised **nominated dispatch bids** (clauses 13.19A and 13.19B):
 - (c) any price and quantity values assigned by the **system operator** under clause 13.69AA:
 - (d) the expected profile of **demand** until the next **dispatch schedule** is produced by the **system operator**, where in an **unsupplied demand situation**—
 - (i) the expected profile of **demand** used to calculate **dispatch instructions** and **dispatch notifications** must reflect the **demand** expected to be supplied by the available **offers**; and
 - (ii) the expected profile of **demand** used to calculate **dispatch price** must be adjusted for the **demand** that was unable to be supplied by the available **offers** that was assigned a value by the **system operator** under clause 13.69AA(a), in accordance with the processes set out in Schedule 13.3AA:
 - (e) the potential output of all **intermittent generating stations**, determined in accordance with subclause (4):
 - (f) the current output levels of each **generator** or, if no such data is available, a reasonable estimate of the current output levels of each **generator**:
 - (g) information from the **grid owner** (clauses 13.29 to 13.34) and revised information from the **grid owner** (clause 13.33) about—
 - (i) the AC transmission system configuration, capacity and **losses**; and
 - (ii) the capability of the **HVDC link** including the **HVDC link configuration**, the capacity of the **HVDC link**, the **losses** in the **HVDC link**, the direction of any transfer limit on the **HVDC link**, and any minimum or maximum transfer limits on the **HVDC link**; and
 - (iii) transformer configuration, capacity and **losses**:
 - (h) information about **voltage support**:
 - (i) the price order in the current **dispatch schedule**:
 - (j) in relation to **intermittent generators**, any ramp rates agreed between the **intermittent generator** and the **system operator**.
- (2) The **system operator** must incorporate, in each schedule prepared, any adjustments to the inputs described in subclause (1) that may be required to meet the **dispatch objective**.

- (3) The **system operator** must use the information provided under clause 13.69AAA as part of its calculation of the expected profile of **demand**.
- (4) The **system operator** must, in determining the potential output of an **intermittent generating station** for the purposes of subclause (1)(e), use the following information:
- (a) if the most recent **dispatch instruction** to the relevant **intermittent generator** for the **intermittent generating station** was not flagged, the actual output in **MW** of the **intermittent generating station**:
 - (b) if the most recent **dispatch instruction** to the relevant **intermittent generator** for the **intermittent generating station** was flagged, the greater of—
 - (i) the forecast of generation potential specified in the **intermittent generator's** final **offer** for the relevant **intermittent generating station** submitted under clause 13.18A; and
 - (ii) the actual output in **MW** of the **intermittent generating station**:
 - (c) if the **intermittent generator** and the **system operator** have agreed in writing that an alternative estimate may be provided, the alternative estimate of the potential output of the **intermittent generating station** provided by the relevant **intermittent generator**.

Clause 13.69B: inserted, by clause 32 of the Electricity Industry Participation Code Amendment (Real Time Pricing) 2022.

Clause 13.69B(1)(g)(i): amended, on 1 March 2024, by clause 73(1) of the Electricity Industry Participation Code Amendment (Code Review Programme) 2024.

Clause 13.69B(1)(g)(ii): replaced, on 1 March 2024, by clause 73(2) of the Electricity Industry Participation Code Amendment (Code Review Programme) 2024.

Clause 13.69B(1)(g)(iii): amended, on 1 March 2024, by clause 73(3) of the Electricity Industry Participation Code Amendment (Code Review Programme) 2024.

13.69C Contents of each dispatch schedule

Each **dispatch schedule** prepared by the **system operator** must contain the information specified in the table in Schedule 13.3B, as indicated by a **X** in column 3 of the table.

Clause 13.69C: inserted, by clause 32 of the Electricity Industry Participation Code Amendment (Real Time Pricing) 2022.

13.69D System operator to verify accuracy of dispatch prices and dispatch reserve prices

The **system operator** must verify the accuracy of **dispatch prices** and **dispatch reserve prices** in each **dispatch schedule** using the method specified in the **policy statement**.

Clause 13.69D: inserted, by clause 32 of the Electricity Industry Participation Code Amendment (Real Time Pricing) 2022.

13.70 System operator may depart from dispatch schedule

The **system operator** may exercise discretion in departing from the **dispatch schedule** only if it is necessary to meet—

- (a) the **dispatch objective**; or
- (b) the requirements of clause 8.5 in relation to restoration of the power system.

Compare: Electricity Governance Rules 2003 rule 4.3 section III part G

13.71 [Revoked]

Compare: Electricity Governance Rules 2003 rule 4.4 section III part G

Clause 13.71(d): amended, on 28 June 2012, by clause 37 of the Electricity Industry Participation (Demand-side Bidding and Forecasting) Code Amendment 2011.

Clause 13.71: substituted, on 15 May 2014, by clause 24 of the Electricity Industry Participation (Modified Dispatchable Demand) Code Amendment 2013.

Clause 13.71(1): amended, on 8 August 2019, by clause 4 of the Electricity Industry Participation Code Amendment (Dispatch Service Enhancement) 2019.

Clause 13.71(1)(b), (d) and (i): amended, on 5 October 2017, by clause 364 of the Electricity Industry Participation Code Amendment (Code Review Programme) 2017.

Clause 13.71(1)(b): amended, at 12.00 pm on 19 September 2019, by clause 17(1) of the Electricity Industry Participation Code Amendment (Wind Offer Arrangements) 2019.

Clause 13.71(1)(c): replaced, at 12.00 pm on 19 September 2019, by clause 17(2) of the Electricity Industry Participation Code Amendment (Wind Offer Arrangements) 2019.

Clause 13.71(1)(e): replaced, at 12.00 pm on 19 September 2019, by clause 17(3) of the Electricity Industry Participation Code Amendment (Wind Offer Arrangements) 2019.

Clause 13.71(3): inserted, at 12.00 pm on 19 September 2019, by clause 17(4) of the Electricity Industry Participation Code Amendment (Wind Offer Arrangements) 2019.

Clause 13.71: revoked, by clause 33 of the Electricity Industry Participation Code Amendment (Real Time Pricing) 2022.

13.72 System operator to issue dispatch instructions and dispatch notifications

- (1) The **system operator** must implement each **dispatch schedule**, and any departure from a **dispatch schedule** under clause 13.70 by—
 - (a) issuing **dispatch instructions** to,—
 - (i) **generators**; and
 - (ii) **ancillary service agents**; and
 - (iii) **dispatchable load purchasers** (other than **dispatch notification purchasers**) that have submitted **nominated dispatch bids**; and
 - (b) issuing **dispatch notifications** to **dispatch notification purchasers** and **dispatch notification generators**.
- (2) The **system operator** must issue each **dispatch instruction** and each **dispatch notification** in a reasonable and timely manner to enable the **participant** to which the **dispatch instruction** or **dispatch notification** is issued to comply with the **dispatch instruction** or **dispatch notification**.
- (3) Despite subclause (1), the **system operator** is not required to issue a **dispatch instruction** to a **participant** if—
 - (a) the **dispatch instruction** is—
 - (i) to provide a quantity of **active power** under clause 13.73(1)(a); or
 - (ii) to provide a quantity of **instantaneous reserve** under clause 13.73(1)(b); and
 - (c) the **dispatch instruction** would differ from the most recent **dispatch instruction** issued to the **participant** by 1 MW or less.

Compare: Electricity Governance Rules 2003 rule 4.5 section III part G

Clause 13.72: substituted, on 15 May 2014, by clause 25 of the Electricity Industry Participation (Modified Dispatchable Demand) Code Amendment 2013.

Clause 13.72: replaced, by clause 34 of the Electricity Industry Participation Code Amendment (Real Time Pricing) 2022.

13.72A Dispatch schedule primary modelling system unavailable

- (1) Where the **system operator's** primary modelling system for preparing and implementing a **dispatch schedule** is unavailable, the **system operator**—
 - (a) must issue **dispatch instructions** and **dispatch notifications** using the backup procedure specified by it from time to time and using the inputs available to it at the relevant time; and
 - (b) is not required to prepare a **dispatch schedule** that complies with the requirements set out in clause 13.69A(1)(a) and clause 13.69A(1)(b).

- (2) When the **system operator** issues **dispatch instructions** in accordance with clause 13.72A(1), such **dispatch instructions** will be deemed to comprise a **dispatch schedule** for the purposes of clause 13.72(1).

Clause 13.72A: inserted, by clause 35 of the Electricity Industry Participation Code Amendment (Real Time Pricing) 2022.

13.73 Content of dispatch instructions and dispatch notifications

- (1) The **system operator** must ensure that each **dispatch instruction** and **dispatch notification** it issues under clause 13.72(1) instructs the **generator**, **ancillary service agent**, or **dispatchable load purchaser** to carry out 1 of the following:

- (a) provide a quantity of **active power**:
- (b) provide a quantity of **instantaneous reserve**:
- (c) provide a quantity and quality of reserve power or alternative to regulate frequency continuously:
- (d) provide a quantity of **reactive power**:
- (e) adjust transformer tap positions to maintain voltage levels:
- (f) provide a level of voltage:
- (g) **synchronise** or **de-synchronise generating plant** within the current **trading period** or the next **trading period** either directly or in accordance with any process that may be agreed with the **generator**:
- (h) switch on or switch off schemes for over frequency tripping where such capability exists in **generating plant** that a **generator** has offered to provide to the **system operator**:
- (i) manage the **generating plant** within a **block dispatch group** or **station dispatch group** so as to ensure the largest single reserve risk within that **block dispatch group** or **station dispatch group** does not exceed the relevant maximum reserve risk advised by the **system operator** for the North Island or the South Island for each **trading period**:
- (j) manage the total aggregate generation for each **sub-block dispatch group** or **sub-station dispatch group** for that **generator** so as not to exceed the total sum of the **dispatched** quantities for each **generating plant** or **generating unit** comprising that **sub-block dispatch group** or **sub-station dispatch group** for the duration of the notice received under clauses 13.60, 13.61, or 13.64 to 13.66:
- (k) manage the total aggregate generation for each **block dispatch group** or **station dispatch group** for that **generator** so as to meet the total sum of the **dispatched** quantities for each **generating station** or **generating unit** comprising that **block dispatch group** or **station dispatch group**:
- (l) use a specified quantity of **electricity**.

- (1A) The **system operator** must include an indication (**flag**) in each **dispatch instruction** it issues to an **intermittent generator** under clause 13.72(1)(a) if the **intermittent generator** is **dispatched** for a **trading period** at a quantity less than the potential output of the relevant **intermittent generating station**.

- (1B) For the purposes of subclause (1A), the potential output of an **intermittent generating station** is the potential output for the relevant **intermittent generating station** determined by the **system operator** under clause 13.69B(4).

- (2) *[Revoked]*

Compare: Electricity Governance Rules 2003 rule 4.6 section III part G

Clause 13.73 Heading: amended, on 3 October 2013, by clause 6(a) of the Electricity Industry Participation (Technology Neutral Language in Frequency Keeping) Code Amendment 2013.

Clause 13.73: amended, on 3 October 2013, by clause 6(b) and (c) of the Electricity Industry Participation (Technology Neutral Language in Frequency Keeping) Code Amendment 2013.

Clause 13.73: substituted, on 15 May 2014, by clause 26 of the Electricity Industry Participation (Modified Dispatchable Demand) Code Amendment 2013.

Clause 13.73(1): amended, on 8 August 2019, by clause 5 of the Electricity Industry Participation Code Amendment (Dispatch Service Enhancement) 2019.

Clause 13.73(1): amended, on 1 November 2022, by clause 36(2) of the Electricity Industry Participation Code Amendment (Real Time Pricing) 2022

Clause 13.73(1)(c): amended, on 3 October 2013, by clause 6(d) of the Electricity Industry Participation (Technology Neutral Language in Frequency Keeping) Code Amendment 2013.

Clause 13.73(1)(i): amended, on 5 October 2017, by clause 365 of the Electricity Industry Participation Code Amendment (Code Review Programme) 2017

Clause 13.73(1)(l): inserted, on 1 November 2022, by clause 36(3) of the Electricity Industry Participation Code Amendment (Real Time Pricing) 2022.

Clause 13.73(1A) and (1B): inserted, at 12.00 pm on 19 September 2019, by clause 18 of the Electricity Industry Participation Code Amendment (Wind Offer Arrangements) 2019.

Clause 13.73(1B): amended, on 1 November 2022, by clause 36(4) of the Electricity Industry Participation Code Amendment (Real Time Pricing) 2022.

Clause 13.73(2): revoked, on 1 November 2022, by clause 36(5) of the Electricity Industry Participation Code Amendment (Real Time Pricing) 2022.

13.74 *[Revoked]*

Compare: Electricity Governance Rules 2003 rule 4.7 section III part G

Clause 13.74: substituted, on 3 October 2013, by clause 7 of the Electricity Industry Participation (Technology Neutral Language in Frequency Keeping) Code Amendment 2013.

Clause 13.74: revoked, on 15 May 2014, by clause 27 of the Electricity Industry Participation (Modified Dispatchable Demand) Code Amendment 2013.

13.75 Form of dispatch instruction and dispatch notification

- (1) When issuing a **dispatch instruction** or **dispatch notification** under clause 13.72(1), the **system operator** must specify—
- (a) the **generating plant, generating unit, block dispatch group, station dispatch group, interruptible load, dispatch-capable load station, or frequency keeping units** to which the **dispatch instruction** or **dispatch notification** applies; and
 - (b) the desired outcome of the **dispatch instruction** or **dispatch notification**; and
 - (c) if the start time for the **dispatch instruction** or **dispatch notification** differs from the issue time, the start time within the current **trading period** or the next **trading period**; and
 - (d) if specific ramp rates are concerned, a specific target time to reach the desired outcome; and
 - (e) the time at which the **dispatch instruction** or **dispatch notification** was issued; and
 - (f) any **block security constraint** that occurs within a **block dispatch group** and how the **block security constraint** divides the **generating stations** or **generating units** of a **block dispatch group** into **sub-block dispatch groups** as part of such a **dispatch instruction** or **dispatch notification**; and
 - (g) any **station security constraint** that occurs within a **station dispatch group** and how the **station security constraint** divides the **generating stations** or

- generating units of a station dispatch group into sub-station dispatch groups; and**
- (h) if it is a **dispatch instruction** or **dispatch notification** specified in clause 13.73(1)(i), the maximum reserve risk for the relevant **island**; and
 - (i) when issuing a **dispatch instruction** or **dispatch notification** to a **dispatchable load purchaser**, the **trading period** for which the **dispatch instruction** or **dispatch notification** is issued.

Compare: Electricity Governance Rules 2003 rule 4.8 section III part G

Clause 13.75(a): amended, on 3 October 2013, by clause 8 of the Electricity Industry Participation (Technology Neutral Language in Frequency Keeping) Code Amendment 2013.

Clause 13.75(1): amended, on 15 May 2014, by clause 28(a) & (b) of the Electricity Industry Participation (Modified Dispatchable Demand) Code Amendment 2013.

Clause 13.75(1)(f): amended, on 1 February 2016, by clause 80(1) of the Electricity Industry Participation Code Amendment (Code Review Programme) 2015.

Clause 13.75(1)(g): amended, on 1 February 2016, by clause 80(2) of the Electricity Industry Participation Code Amendment (Code Review Programme) 2015.

Clause 13.75(1)(h): inserted, on 15 May 2014, by clause 28(c) of the Electricity Industry Participation (Modified Dispatchable Demand) Code Amendment 2013.

Clause 13.75(2): inserted, on 15 May 2014, by clause 28(d) of the Electricity Industry Participation (Modified Dispatchable Demand) Code Amendment 2013.

Clause 13.75: replaced, on 1 November 2022, by clause 37 of the Electricity Industry Participation Code Amendment (Real Time Pricing) 2022.

13.76 System operator to issue and log dispatch instructions and dispatch notifications

- (1) The **system operator** must issue **dispatch instructions** and **dispatch notifications**—
 - (a) to each **generator** (other than a **generator** receiving **dispatch instructions** in its capacity as an **ancillary service agent**) and each **dispatchable load purchaser**, using an **approved system**; and
 - (b) to each **ancillary service agent**, using an **approved system** or as otherwise agreed in the relevant **ancillary service arrangement**.
- (2) The **system operator** must log and record each **dispatch instruction** and each **dispatch notification**.
- (3) Each **generator** and each **ancillary service agent** must log each **dispatch instruction** received from the **system operator**.
- (4) The **system operator** must provide a copy of each **dispatch instruction** and each **dispatch notification**—
 - (a) to the **clearing manager**, by 1600 hours on the 7th **business day** of the **billing period** after the **billing period** in which the **system operator** issues and logs the **dispatch instruction** or **dispatch notification**; and
 - (b) to the **Authority**, by 1600 hours on the first **business day** after the day on which the **system operator** issues and logs the **dispatch instruction** or **dispatch notification**.

Compare: Electricity Governance Rules 2003 rule 4.9 section III part G

Clause 13.76 Heading: replaced, on 5 October 2017, by clause 366(1) of the Electricity Industry Participation Code Amendment (Code Review Programme) 2017.

Clause 13.76: substituted, on 15 May 2014, by clause 29 of the Electricity Industry Participation (Modified Dispatchable Demand) Code Amendment 2013.

Clause 13.76(1): replaced, on 5 October 2017, by clause 366(2) of the Electricity Industry Participation Code Amendment (Code Review Programme) 2017.

Clause 13.76(1)(a): amended, on 8 August 2019, by clause 6(1) of the Electricity Industry Participation Code Amendment (Dispatch Service Enhancement) 2019.

Clause 13.76(1)(c): amended, on 8 August 2019, by clause 6(2) of the Electricity Industry Participation Code Amendment (Dispatch Service Enhancement) 2019.

Clause 13.76(2): revoked, on 5 October 2017, by clause 366(3) of the Electricity Industry Participation Code Amendment (Code Review Programme) 2017.

Clause 13.76(5): substituted, on 19 May 2016, by clause 31 of the Electricity Industry Participation Code Amendment (System Operator and Alignment with Statutory Objective) 2016.

Clause 13.76(6): amended, on 15 May 2014, by clause 45 of the Electricity Industry Participation (Minor Code Amendments) Code Amendment 2014. Clause 13.76: replaced, on 1 November 2022, by clause 38 of the Electricity Industry Participation Code Amendment (Real Time Pricing) 2022.

13.77 *[Revoked]*

Compare: Electricity Governance Rules 2003 rule 4.9.1 section III part G

Clause 13.77: revoked, on 15 May 2014, by clause 30 of the Electricity Industry Participation (Modified Dispatchable Demand) Code Amendment 2013.

13.78 *[Revoked]*

Compare: Electricity Governance Rules 2003 rule 4.9.2 section III part G

Clause 13.78: revoked, on 15 May 2014, by clause 30 of the Electricity Industry Participation (Modified Dispatchable Demand) Code Amendment 2013.

13.79 Acknowledgement of dispatch instructions

If the **system operator** has issued a **dispatch instruction** or **dispatch notification** to a **participant** under clause 13.72(1), the **participant** must acknowledge to the **system operator** receipt of that **dispatch instruction** or **dispatch notification**—

- (a) within 4 minutes of receiving that **dispatch instruction** or **dispatch notification**;
or
- (b) if the **system operator** and that person have entered into a written agreement relating to the person's acknowledgement of receipt of **dispatch instructions** or **dispatch notifications** that conflicts with paragraph (a), in accordance with that agreement, which may include an agreement that the person need not acknowledge receipt of some or all **dispatch instructions** or **dispatch notifications**.

Compare: Electricity Governance Rules 2003 rule 4.9.3 section III part G

Clause 13.79: amended, on 21 September 2012, by clause 19 of the Electricity Industry Participation (Minor Amendments) Code Amendment 2012.

Clause 13.79: replaced, on 8 August 2019, by clause 7 of the Electricity Industry Participation Code Amendment (Dispatch Service Enhancement) 2019.

Clause 13.79: replaced, on 1 November 2022, by clause 39 of the Electricity Industry Participation Code Amendment (Real Time Pricing) 2022.

13.80 *[Revoked]*

Compare: Electricity Governance Rules 2003 rule 4.9.4 section III part G

Clause 13.80(1): amended, on 21 September 2012, by clause 20 of the Electricity Industry Participation (Minor Amendments) Code Amendment 2012.

Clause 13.80(1): amended, on 15 May 2014, by clause 31 of the Electricity Industry Participation (Modified Dispatchable Demand) Code Amendment 2013.

Clause 13.80(1): amended, on 15 May 2014, by clause 46 of the Electricity Industry Participation (Minor Code Amendments) Code Amendment 2014.

Clause 13.80(1): amended, on 23 February 2015, by clause 75 of the Electricity Industry Participation Code Amendment (Distributed Generation) 2014.

Clause 13.80(1): amended, on 5 October 2017, by clause 367 of the Electricity Industry Participation Code Amendment (Code Review Programme) 2017.

Clause 13.80: revoked, on 1 November 2022, by clause 40 of the Electricity Industry Participation Code Amendment (Real Time Pricing) 2022.

13.81 Backup procedures if communication not possible

The **system operator** must follow the back-up procedures specified by it from time to time for issuing **dispatch instructions** and **dispatch notifications** if—

- (a) the relevant mechanism described in clause 13.76(1)(a) or 13.76(1)(b) is not available to issue **dispatch instructions** or **dispatch notifications** under clause 13.72(1); or
- (b) subject to any agreement referred to in clause 13.79(b), the **system operator** does not receive an acknowledgement from a **participant** of receipt of a **dispatch instruction** or **dispatch notification** within 10 minutes after issuing the **dispatch instruction** or **dispatch notification**.

Compare: Electricity Governance Rules 2003 rule 4.10 section III part G

Clause 13.81(1)(a): substituted, on 15 May 2014, by clause 32(a) of the Electricity Industry Participation (Modified Dispatchable Demand) Code Amendment 2013.

Clause 13.81(1)(b): amended, on 15 May 2014, by clause 47 of the Electricity Industry Participation (Minor Code Amendments) Code Amendment 2014.

Clause 13.81(1): amended, on 8 August 2019, by clause 8(1), (2) and (3) of the Electricity Industry Participation Code Amendment (Dispatch Service Enhancement) 2019.

Clause 13.81(2): inserted, on 15 May 2014, by clause 32(b) of the Electricity Industry Participation (Modified Dispatchable Demand) Code Amendment 2013.

Clause 13.81(2): amended, on 5 October 2017, by clause 368 of the Electricity Industry Participation Code Amendment (Code Review Programme) 2017.

Clause 13.81(2): amended, on 8 August 2019, by clause 8(4) of the Electricity Industry Participation Code Amendment (Dispatch Service Enhancement) 2019.

Clause 13.81: replaced, on 1 November 2022, by clause 41 of the Electricity Industry Participation Code Amendment (Real Time Pricing) 2022.

13.82 Dispatch instructions to be complied with

- (1) This clause applies to—
 - (a) a **generator**; and
 - (b) an **ancillary service agent**; and
 - (c) a **dispatched purchaser**.
- (2) Each **participant** to which this clause applies must comply with a **dispatch instruction** properly issued by the **system operator** under clause 13.72(1)(a) unless,—
 - (a) in the **participant's** reasonable opinion,—
 - (i) personnel or plant safety is at risk; or
 - (ii) following the **dispatch instruction** will contravene a law; or
 - (b) the **generating plant** or **dispatch-capable load station** is already responding to an automated signal to activate—
 - (i) **capacity reserve**; or
 - (ii) **instantaneous reserve**; or
 - (iii) **automatic under-frequency load shedding**; or
 - (iv) **over frequency reserve**; or
 - (c) the **participant** is a **generator** or **ancillary service agent** acting in accordance with clause 13.86; or
 - (d) the **participant** is an **intermittent generator** and the **system operator** has not **flagged** the **dispatch instruction** in accordance with clause 13.73(1A); or
 - (e) the **participant**—
 - (i) is a **generator**; and
 - (ii) deviates from a **dispatch instruction** for **active power** to comply with clause 8.17; or

- (f) the **participant**—
 - (i) is a **dispatched purchaser**; and
 - (ii) deviates from the **dispatch instruction**—
 - (A) to comply with a request issued by the **system operator** under clause 5(4) of **Technical Code B** of Schedule 8.3; or
 - (B) to comply with clause 8.18; or
 - (g) the **participant**—
 - (i) is a **dispatched purchaser**; and
 - (ii) cannot comply with the **dispatch instruction** because **demand** has been **electrically disconnected** under clause 7(20) of **Technical Code B** of Schedule 8.3; or
 - (ga) the **participant**—
 - (i) is a **dispatched purchaser**; and
 - (ii) the **dispatch instruction** is issued for a **trading period** for which the latest **nominated bid** for the relevant **dispatch-capable load station** is a **nominated non-dispatch bid**; or
 - (h) the **participant**—
 - (i) is a **generator** or an **ancillary service agent**; and
 - (ii) deviates from a **dispatch instruction** to comply with clause 9 of **Technical Code B** of Schedule 8.3; or
 - (i) the **participant**—
 - (i) is a **generator** or an **ancillary service agent**; and
 - (ii) is acting in accordance with a **commissioning** plan or test plan that—
 - (A) is required under clause 2(6) of **Technical Code A** of Schedule 8.3; and
 - (B) expressly allows the **generator** or **ancillary service agent** to depart from the **dispatch instruction** for the purpose of the **commissioning** plan or test plan; and
 - (iii) has no reasonable means of complying with the **dispatch instruction** while acting in accordance with the **commissioning** plan or test plan; or
 - (j) the **participant** is a **type B co-generator** and the **system operator** has not advised that there is—
 - (i) a **grid emergency**; or
 - (ii) a **system constraint** that directly affects the **type B co-generator**.
- (3) A **participant** to which the exception in subclause (2)(a) applies must immediately advise the **system operator** of the circumstance in which the exception arises.
- (4) If a **dispatched purchaser** is issued with more than 1 **dispatch instruction** for the same **dispatch-capable load station** for the same **trading period**, the **dispatched purchaser** must comply with the latest **dispatch instruction**.
- (5) To avoid doubt, a **dispatch instruction** listed in clause 13.73(1)(b) to 13.73(1)(f) or 13.73(1)(h) is properly issued only if—
- (a) the **generator** or **ancillary service agent** to which the **dispatch instruction** is given has an enforceable contract with the **system operator** for the provision of services relating to the **dispatch instruction**; or
 - (b) the **dispatch instruction** is consistent with an enforceable contract between the **system operator** and the **generator** or **ancillary service agent** for the provision of services relating to the **dispatch instruction**; or
 - (c) the **dispatch instruction** is given for the purposes of clause 8.5 or 13.70; or
 - (d) the **dispatch instruction** is consistent with—

- (i) the **asset owner performance obligations** under clauses 8.22 to 8.24; or
 - (ii) the **technical codes** concerning voltage; or
 - (iii) a **dispensation**.
- (6) A **dispatched purchaser** issued with a **dispatch instruction** for a **dispatch-capable load station** must not make changes to its other load at the same **GXP** with the intention of offsetting the **dispatch instruction** for the **dispatch-capable load station**.
- Compare: Electricity Governance Rules 2003 rule 4.11 section III part G
Clause 13.82: substituted, on 15 May 2014, by clause 33 of the Electricity Industry Participation (Modified Dispatchable Demand) Code Amendment 2013.
Clause 13.82: amended, on 1 November 2022, by clause 42 of the Electricity Industry Participation Code Amendment (Real Time Pricing) 2022.
Clause 13.82(2)(d): amended, on 29 June 2017, by clause 34 of the Electricity Industry Participation Code Amendment (Shortened Gate Closure and Revised Bid and Offer Provisions) 2017.
Clause 13.82(2)(d)(ii): amended, on 27 May 2015, by clause 8(1) of the Electricity Industry Participation Code Amendment (Industrial Co-generation Dispatch Arrangements) 2015.
Clause 13.82(2)(d): replaced, at 12.00 pm on 19 September 2019, by clause 19 of the Electricity Industry Participation Code Amendment (Wind Offer Arrangements) 2019.
Clause 13.82(2)(g)(ii): amended, on 7 August 2014, by clause 23 of the Electricity Industry Participation Code Amendment (Extended Reserve) 2014.
Clause 13.82(2)(ga): inserted, on 1 December 2015, by clause 5 of the Electricity Industry Participation Code Amendment (Dispatchable Demand: Late Bid Revisions) 2015.
Clause 13.82(2)(h): inserted, on 18 April 2013, by clause 4 of the Electricity Industry Participation (Dispatch Compliance Minor Amendment) Code Amendment 2013.
Clause 13.82(2)(i)(iii): amended, on 27 May 2015, by clause 8(2) of the Electricity Industry Participation Code Amendment (Industrial Co-generation Dispatch Arrangements) 2015.
Clause 13.82(2)(j): inserted, on 27 May 2015, by clause 8(3) of the Electricity Industry Participation Code Amendment (Industrial Co-generation Dispatch Arrangements) 2015.
Clause 13.82(2)(g)(ii) and (2)(i): amended, on 5 October 2017, by clause 369 of the Electricity Industry Participation Code Amendment (Code Review Programme) 2017.
Clause 13.82(2)(g)(ii): amended, on 21 December 2012, by clause 31 of the Electricity Industry Participation Code Amendment (Automatic Under-Frequency Load Shedding Systems) 2021.

13.82A Compliance with dispatch notifications

- (1) Each **dispatch notification purchaser** and **dispatch notification generator** that receives a **dispatch notification** issued by the **system operator** under clause 13.72(1)(b) must either—
- (a) comply with the **dispatch notification**; or
 - (b) comply with clause 13.19C.
- (2) To avoid doubt, a **dispatch notification generator** is not prohibited from generating in a **trading period** for which it has submitted an **offer** of 0 MW.
- Clause 13.82A: inserted, on 1 November 2022, by clause 43 of the Electricity Industry Participation Code Amendment (Real Time Pricing) 2022.

13.82B Dispatch notification purchasers and dispatch notification generators to provide information

- (1) Each **dispatch notification purchaser**, in respect of each **dispatch-capable load station** for which it submits **nominated bids**, and each **dispatch notification generator**, in respect of each **generating unit** or **generating station** for which it submits **offers**, must provide information about the usage or provision of electricity, and any other information the **Authority** may reasonably require, for the purpose of monitoring compliance with Part 13.
- (2) Each **dispatch notification purchaser** and each **dispatch notification generator** must agree with the **Authority** the format, time periods to be captured, method of delivery and frequency of delivery for information provided under subclause (1).

Clause 13.82B: inserted, on 1 March 2024, by clause 9 of the Electricity Industry Participation Code Amendment (Dispatch Notification Enhancement and Clarifications) 2024.

13.83 Generators to make staff or facilities available to meet dispatch instructions and dispatch notifications

- (1) Each **generator** must ensure, with respect to its **generating plant** that is the subject of an **offer**, that appropriate personnel or facilities are available to receive, acknowledge (subject to any agreement referred to in clause 13.79(b)), and comply with any **dispatch instruction** or **dispatch notification** given by the **system operator** to the **generator**.
- (2) Nothing in this clause limits the ability of a **generator** to have a control centre that operates 1 or more items of **generating plant** by remote control.

Compare: Electricity Governance Rules 2003 rule 4.12 section III part G

Clause 13.83 Heading: amended, on 1 November 2022, by clause 44(1) of the Electricity Industry Participation Code Amendment (Real Time Pricing) 2022.

Clause 13.83(1): amended, on 8 August 2019, by clause 9 of the Electricity Industry Participation Code Amendment (Dispatch Service Enhancement) 2019.

Clause 13.83: amended, on 1 November 2022, by clause 44(2) of the Electricity Industry Participation Code Amendment (Real Time Pricing) 2022.

13.83A Dispatchable load purchasers to make staff or facilities available to meet dispatch instructions and dispatch notifications

- (1) Each **dispatchable load purchaser** that has submitted a **nominated dispatch bid** must ensure that appropriate personnel or facilities are available to receive and comply with each **dispatch instruction** or **dispatch notification** issued to the **dispatchable load purchaser**.
- (2) Nothing in this clause limits the ability of a **dispatchable load purchaser** to have a control centre that operates 1 or more **dispatch-capable load stations** by remote control.

Clause 13.83A Heading: amended, on 1 November 2022, by clause 45(1) of the Electricity Industry Participation Code Amendment (Real Time Pricing) 2022.

Clause 13.83A: inserted, on 15 May 2014, by clause 34 of the Electricity Industry Participation (Modified Dispatchable Demand) Code Amendment 2013.

Clause 13.83A(1): amended, on 1 November 2022, by clause 45(2) of the Electricity Industry Participation Code Amendment (Real Time Pricing) 2022.

13.84 Ancillary service agents to make staff or facilities available to meet dispatch instructions

Each **ancillary service agent** must ensure that appropriate personnel or facilities are available to receive, acknowledge (subject to any agreement referred to in clause 13.79(b)), and comply with any **dispatch instruction** given by the **system operator** to that **ancillary service agent**.

Compare: Electricity Governance Rules 2003 rule 4.13 section III part G

Clause 13.84: amended, on 8 August 2019, by clause 10 of the Electricity Industry Participation Code Amendment (Dispatch Service Enhancement) 2019.

13.85 Generators have flexibility within block dispatch group or station dispatch group

Each **generator** may **synchronise**, **de-synchronise**, or alter the output of any **generating plant** within a **block dispatch group** or **station dispatch group** if it first consults with the **system operator** with regard to such action.

Compare: Electricity Governance Rules 2003 rule 4.15 section III part G

13.86 Generators and ancillary service agents not obliged to comply with dispatch instructions below threshold

A **generator**, or **ancillary service agent** providing **instantaneous reserve** or **frequency keeping**, is not required to comply with 1 or more **dispatch instructions** given by the **system operator** in accordance with clause 13.72(1)(a) if implementing the **dispatch instruction** or those **dispatch instructions** together would change by less than or equal to—

- (a) for **ancillary service agents**, 1 MW from the last **dispatch instruction** that the **ancillary service agent** complied with; or
- (b) for **generators** other than **type A co-generators**, 1 MW from the last **dispatch instruction** that the **generator** complied with; or
- (c) for **type A co-generators**, 5 MW from the last **dispatch instruction** that the **type A co-generator** complied with.

Compare: Electricity Governance Rules 2003 rule 4.16 section III part G

Cross heading: revoked, on 28 June 2012, by clause 38(1) of the Electricity Industry Participation (Demand-side Bidding and Forecasting) Code Amendment 2011.

Clause 13.86: amended, on 15 May 2014, by clause 35 of the Electricity Industry Participation (Modified Dispatchable Demand) Code Amendment 2013.

Clause 13.86: amended, on 8 August 2019, by clause 11 of the Electricity Industry Participation Code Amendment (Dispatch Service Enhancement) 2019.

Clause 13.86(b): amended, on 27 May 2015, by clause 9(1) of the Electricity Industry Participation Code Amendment (Industrial Co-generation Dispatch Arrangements) 2015.

Clause 13.86(c): amended, on 27 May 2015, by clause 9(2)(i) and (ii) of the Electricity Industry Participation Code Amendment (Industrial Co-generation Dispatch Arrangements) 2015.

13.86A Intermittent generators must not substantially reduce generation

- (1) An **intermittent generator** must not generate **electricity** during a **trading period** at a rate that is more than 30MW below the **forecast of generation potential** specified in the **intermittent generator's final offer** for the **trading period** submitted under clause 13.18A, unless—
 - (a) the **intermittent generator** reduces the output of the relevant **intermittent generating station** in order to comply with a **flagged dispatch instruction** under clause 13.73(1A), or any other instruction issued by the **system operator**; or
 - (b) the **intermittent generator** has a **bona fide physical reason**.
- (2) If an **intermittent generator** generates **electricity** during a **trading period** at a rate that is below the rate specified in subclause (1) for 1 or more **trading periods** in a calendar month, other than for one of the reasons specified in subclause (1)(a), the **intermittent generator** must provide a report to the **Authority** no later than the end of the next calendar month.
- (3) A report provided to the **Authority** under subclause (2) must specify—
 - (a) the **trading periods** in relation to which the **intermittent generator** generated **electricity** at a rate that was below the rate specified in subclause (1); and
 - (b) in relation to each such **trading period**, an explanation of the reason for the **intermittent generator** generating **electricity** at a rate that was below the rate specified in subclause (1); and
 - (c) if the **intermittent generator** considers that one of the reasons in subclause (1)

applies in respect of any of the **trading periods** specified in the report, the **intermittent generator's** reasons for that view.

Clause 13.86A: inserted, at 12.00 pm on 19 September 2019, by clause 20 of the Electricity Industry Participation Code Amendment (Wind Offer Arrangements) 2019.

13.87 *[Revoked]*

Clause 13.87: revoked, on 28 June 2012, by clause 38(2) of the Electricity Industry Participation (Demand-side Bidding and Forecasting) Code Amendment 2011.

13.88 *[Revoked]*

Compare: Electricity Governance Rules 2003 rule 6 section III part G

Clause 13.88 Heading: amended, on 28 June 2012, by clause 39(1) of the Electricity Industry Participation (Demand-side Bidding and Forecasting) Code Amendment 2011.

Clause 13.88 (1)-(4): amended, on 28 June 2012, by clause 39(2)-(4) of the Electricity Industry Participation (Demand-side Bidding and Forecasting) Code Amendment 2011.

Clause 13.88: revoked, on 1 November 2022, by clause 47 of the Electricity Industry Participation Code Amendment (Real Time Pricing) 2022.

13.89 *[Revoked]*

Compare: Electricity Governance Rules 2003 rule 7.1 section III part G

Clause 13.89 Heading: amended, on 28 June 2012, by clause 40(1) of the Electricity Industry Participation (Demand-side Bidding and Forecasting) Code Amendment 2011.

Clause 13.89: amended, on 28 June 2012, by clause 40(2) of the Electricity Industry Participation (Demand-side Bidding and Forecasting) Code Amendment 2011.

Clause 13.89: revoked, on 1 November 2022, by clause 48 of the Electricity Industry Participation Code Amendment (Real Time Pricing) 2022.

13.90 *[Revoked]*

Compare: Electricity Governance Rules 2003 rule 7.2 section III part G

Clause 13.90 Heading: replaced, on 5 October 2017, by clause 370(1) of the Electricity Industry Participation Code Amendment (Code Review Programme) 2017.

Clause 13.90(1): amended, on 5 October 2017, by clause 370(2)(a) of the Electricity Industry Participation Code Amendment (Code Review Programme) 2017.

Clause 13.90(1): amended, on 28 June 2012, by clause 41 of the Electricity Industry Participation (Demand-side Bidding and Forecasting) Code Amendment 2011.

Clause 13.90(1)(b)(i) and (ii): amended, on 1 February 2016, by clause 81 of the Electricity Industry Participation Code Amendment (Code Review Programme) 2015.

Clause 13.90(1)(b)(ii): substituted, on 15 May 2014, by clause 48 of the Electricity Industry Participation (Minor Code Amendments) Code Amendment 2014.

Clause 13.90(1)(b)(iii): amended, on 15 May 2014, by clause 36 of the Electricity Industry Participation (Modified Dispatchable Demand) Code Amendment 2013.

Clause 13.90(1)(b)(iii)(A): amended, on 21 September 2012, by clause 21 of the Electricity Industry Participation (Minor Amendments) Code Amendment 2012.

Clause 13.90(2): replaced, on 5 October 2017, by clause 370(2)(b) of the Electricity Industry Participation Code Amendment (Code Review Programme) 2017.

Clause 13.90: revoked, on 1 November 2022, by clause 49 of the Electricity Industry Participation Code Amendment (Real Time Pricing) 2022.

13.91 *[Revoked]*

Compare: Electricity Governance Rules 2003 rules 7.3 to 7.5 section III part G

Clause 13.91 Heading: replaced, on 5 October 2017, by clause 371(1) of the Electricity Industry Participation Code Amendment (Code Review Programme) 2017.

Clause 13.91(1): revoked, on 5 October 2017, by clause 371(2)(a) of the Electricity Industry Participation Code Amendment (Code Review Programme) 2017.

Clause 13.91(2) and (3): replaced, on 5 October 2017, by clause 371(2)(b) of the Electricity Industry Participation Code Amendment (Code Review Programme) 2017.

Clause 13.91: revoked, on 1 November 2022, by clause 50 of the Electricity Industry Participation Code Amendment (Real Time Pricing) 2022.

13.92 *[Revoked]*

Compare: Electricity Governance Rules 2003 rules 7.6 and 7.7 section III part G
Clause 13.92: replaced, on 5 October 2017, by clause 372 of the Electricity Industry Participation Code Amendment (Code Review Programme) 2017.
Clause 13.92: revoked, on 1 November 2022, by clause 51 of the Electricity Industry Participation Code Amendment (Real Time Pricing) 2022.

13.93 *[Revoked]*

Compare: Electricity Governance Rules 2003 rules 7.8 and 7.9 section III part G
Clause 13.93 Heading: amended, on 5 October 2017, by clause 373(1) of the Electricity Industry Participation Code Amendment (Code Review Programme) 2017.
Clause 13.93(1): replaced, on 5 October 2017, by clause 373(2) of the Electricity Industry Participation Code Amendment (Code Review Programme) 2017.
Clause 13.93(2): amended, on 5 October 2017, by clause 373(3) of the Electricity Industry Participation Code Amendment (Code Review Programme) 2017.
Clause 13.93: revoked, on 1 November 2022, by clause 52 of the Electricity Industry Participation Code Amendment (Real Time Pricing) 2022.

13.94 *[Revoked]*

Compare: Electricity Governance Rules 2003 rule 7.10 section III part G
Clause 13.94: revoked, on 1 November 2022, by clause 53 of the Electricity Industry Participation Code Amendment (Real Time Pricing) 2022.

13.95 *[Revoked]*

Compare: Electricity Governance Rules 2003 rule 7.11 section III part G
Clause 13.95: revoked, on 1 November 2022, by clause 54 of the Electricity Industry Participation Code Amendment (Real Time Pricing) 2022.

13.96 *[Revoked]*

Compare: Electricity Governance Rules 2003 rule 7.12 section III part G
Clause 13.96: substituted, on 15 May 2014, by clause 37 of the Electricity Industry Participation (Modified Dispatchable Demand) Code Amendment 2013.
Clause 13.96: revoked, on 1 November 2022, by clause 55 of the Electricity Industry Participation Code Amendment (Real Time Pricing) 2022.

Grid emergencies

13.97 Grid emergency situations

- (1) The **system operator** may, at any time, declare a **grid emergency** in accordance with **Technical Code B** of Schedule 8.3.
- (2) Despite clauses 13.6 to 13.27 and clauses 13.37 to 13.54, if the **system operator** has declared a **grid emergency**,—
 - (a) a **generator** may not reduce the **MW** specified in any of the **offers** made by the **generator** for the **trading periods** and **grid injection points** affected by the **grid emergency**, unless the **generator** has a **bona fide physical reason** that makes the reduction necessary; and
 - (b) an **ancillary service agent** may not reduce the **instantaneous reserve** specified in any of the **reserve offers** made by the **ancillary service agent** for the **trading periods** and **points of connection** with the **grid** affected by the **grid emergency**, unless the **ancillary service agent** has a **bona fide physical reason** that makes the reduction necessary; and
 - (c) the **system operator** must accept any reduction made under paragraphs (a) or (b).

- (3) Subclause (2)(a) does not apply in relation to the **MW** specified in the **forecast of generation potential** specified in any of the **offers** made by an **intermittent generator**.

Compare: Electricity Governance Rules 2003 rules 8.1 and 8.2 section III part G

Clause 13.97(2): amended, on 29 June 2017, by clause 35(1) of the Electricity Industry Participation Code Amendment (Shortened Gate Closure and Revised Bid and Offer Provisions) 2017.

Clause 13.97(2)(a): amended, on 29 June 2017, by clause 35(2)(a) and (b) of the Electricity Industry Participation Code Amendment (Shortened Gate Closure and Revised Bid and Offer Provisions) 2017.

Clause 13.97(2)(a): amended, at 12.00 pm on 19 September 2019, by clause 21(1) of the Electricity Industry Participation Code Amendment (Wind Offer Arrangements) 2019.

Clause 13.97(2)(b): amended, on 29 June 2017, by clause 35(3)(a) and (b) of the Electricity Industry Participation Code Amendment (Shortened Gate Closure and Revised Bid and Offer Provisions) 2017.

Clause 13.97(3): inserted, at 12.00 pm on 19 September 2019, by clause 21(2) of the Electricity Industry Participation Code Amendment (Wind Offer Arrangements) 2019.

13.98 Generators and ancillary service agents may change other parameters

Despite clause 13.97(2), during a **grid emergency**,—

- (a) a **generator** may reduce the **MW** specified in any price band offered in respect of certain **generating plant**, if equivalent increased **MW** is, in substitution, offered for other items of **generating plant** owned or operated by that **generator** at **grid injection points** in the electrical or geographical region affected as specified in the **system operator's** notice issued under clause 5(1) of **Technical Code B** of Schedule 8.3; and
- (b) an **ancillary service agent** may reduce the **instantaneous reserves** offered, if equivalent increased **instantaneous reserves** are, in substitution, offered by that **ancillary service agent** at **points of connection** with the **grid** in the electrical or geographical region affected as specified in the **system operator's** notice issued under clause 5(1) of **Technical Code B** of Schedule 8.3; and
- (c) despite clauses 13.6 to 13.27, a **generator** may—
 - (i) submit revised **offers** in respect of **generating plant** already subject to an **offer** before the **grid emergency**, so that the total **MW** offered by the **generator** from the **generating plant** for that **trading period** is increased; and
 - (ii) submit new **offers** in respect of a **generating plant** not subject to an **offer** before the **grid emergency**; and
- (d) despite clause 13.17(2), a **generator** may submit a new price band or bands for new **offers** or revised **offers** in respect of the increased **MW** made under paragraph (c), but may not revise the price band or bands in respect of the **MW** offered before the notice of the **grid emergency**; and
- (e) despite clauses 13.37 to 13.54, an **ancillary service agent** may—
 - (i) submit revised **reserve offers** in respect of any **instantaneous reserve** already subject to a **reserve offer** before the **grid emergency** so that the total **instantaneous reserve** offered by the **ancillary service agent** for that **trading period** is increased; and
 - (ii) submit new **reserve offers** in respect of any **instantaneous reserve** not subject to a **reserve offer** before the **grid emergency**; and
- (f) despite clause 13.46(1A), an **ancillary service agent** may submit a new price band or bands for new **reserve offers** or revised **reserve offers** in respect of the increased **instantaneous reserve** made under paragraph (e), but may not revise

the type of **instantaneous reserve** or the price band or bands in respect of the **instantaneous reserve** offered before the notice of the **grid emergency**.

Compare: Electricity Governance Rules 2003 rule 8.3 section III part G

Clause 13.98(a): amended, on 29 June 2017, by clause 36(1)(a), (b) and (c) of the Electricity Industry Participation Code Amendment (Shortened Gate Closure and Revised Bid and Offer Provisions) 2017.

Clause 13.98(a) and (b): amended, on 5 October 2017, by clause 374 of the Electricity Industry Participation Code Amendment (Code Review Programme) 2017.

Clause 13.98(b): amended, on 29 June 2017, by clause 36(2)(a) and (b) of the Electricity Industry Participation Code Amendment (Shortened Gate Closure and Revised Bid and Offer Provisions) 2017.

Clause 13.98(c)(i): amended, on 29 June 2017, by clause 36(3) of the Electricity Industry Participation Code Amendment (Shortened Gate Closure and Revised Bid and Offer Provisions) 2017.

Clause 13.98(d): amended, on 29 June 2017, by clause 36(4)(a), (b) and (c) of the Electricity Industry Participation Code Amendment (Shortened Gate Closure and Revised Bid and Offer Provisions) 2017.

Clause 13.98(e): amended, on 29 June 2017, by clause 36(5) of the Electricity Industry Participation Code Amendment (Shortened Gate Closure and Revised Bid and Offer Provisions) 2017.

Clause 13.98(f): amended, on 29 June 2017, by clause 36(6)(a), (b) and (c) of the Electricity Industry Participation Code Amendment (Shortened Gate Closure and Revised Bid and Offer Provisions) 2017.

13.99 Effect of grid emergency on total quantities bid

Despite clauses 13.19A to 13.27, if the **system operator** has declared a **grid emergency**—

- (a) a **purchaser** may not increase the aggregate quantity of **electricity** specified in all of the **nominated bids** made by the **purchaser** for the **trading periods** and **GXPs** affected by the **grid emergency** unless the **purchaser** has a **bona fide physical reason** that necessitates the increase; and
- (b) the **system operator** must accept any revision made under paragraph (a).

Compare: Electricity Governance Rules 2003 rule 8.4 section III part G

Clause 13.99: amended, on 29 June 2017, by clause 37 of the Electricity Industry Participation Code Amendment (Shortened Gate Closure and Revised Bid and Offer Provisions) 2017.

Clause 13.99(a): amended, on 28 June 2012, by clause 42 of the Electricity Industry Participation (Demand-side Bidding and Forecasting) Code Amendment 2011.

Clause 13.99(a): amended, on 15 May 2014, by clause 38 of the Electricity Industry Participation (Modified Dispatchable Demand) Code Amendment 2013.

13.99A [Revoked]

Clause 13.99A: revoked, on 1 November 2022, by clause 56 of the Electricity Industry Participation Code Amendment (Real Time Pricing) 2022.

13.100 Purchasers may change other parameters

Despite clause 13.99, during a **grid emergency**, a **purchaser** may—

- (a) increase a **nominated bid's** quantities, or submit **nominated bids** at **GXPs** that were not subject to **nominated bids** before the **grid emergency**, if equivalent decreased quantities are, in substitution, bid for **GXPs** in the affected electrical or geographical region, as specified in the **formal notice** issued by the **system operator**, which were the subject of **nominated bids** made by the **purchaser**; and
- (b) decrease a **nominated bid's** quantities.

Compare: Electricity Governance Rules 2003 rule 8.5 section III part G

Clause 13.100(a): substituted, on 28 June 2012, by clause 43(1) of the Electricity Industry Participation (Demand-side Bidding and Forecasting) Code Amendment 2011.

Clause 13.100(b): amended, on 28 June 2012, by clause 43(2) of the Electricity Industry Participation (Demand-side Bidding and Forecasting) Code Amendment 2011.

Clause 13.100(a): amended, on 15 May 2014, by clause 40(a) of the Electricity Industry Participation (Modified Dispatchable Demand) Code Amendment 2013.

Clause 13.100(b): substituted, on 15 May 2014, by clause 40(b) of the Electricity Industry Participation (Modified Dispatchable Demand) Code Amendment 2013.

13.101 Reporting requirements in respect of grid emergencies

- (1) If the **system operator** declares a **grid emergency**,—
- (a) the **system operator** must, within 12 hours of the conclusion of the **grid emergency**, **publish** a written report that describes the basis on which the **system operator** decided to declare the **grid emergency**; and
 - (b) a **generator** that reduced the **MW** specified in any price band in any **offer**, and an **ancillary service agent** that reduced the **instantaneous reserve** specified in any **reserve offer**, made by that person in respect of the **point of connection** with the **grid** and **trading periods** affected by the **grid emergency** must report the reduction to the **Authority** in writing together with details of the **bona fide physical reason** for the reduction claimed by the **generator** or **ancillary service agent**. A reduction must be reported to the **Authority** by 1700 hours on the 1st **business day** after the **trading day** on which the reduction was made.
 - (c) *[Revoked]*
- (2) *[Revoked]*

Compare: Electricity Governance Rules 2003 rules 8.6 and 8.7 section III part G

Clause 13.101(1)(a): substituted, on 1 February 2016, by clause 82 of the Electricity Industry Participation Code Amendment (Code Review Programme) 2015.

Clause 13.101(1)(b): amended, on 28 June 2012, by clause 44(1) of the Electricity Industry Participation (Demand-side Bidding and Forecasting) Code Amendment 2011.

Clause 13.101(1)(b): amended, on 29 June 2017, by clause 38(1)(a), (b) and (c) of the Electricity Industry Participation Code Amendment (Shortened Gate Closure and Revised Bid and Offer Provisions) 2017.

Clause 13.101(1)(c): substituted, on 28 June 2012, by clause 44(2) of the Electricity Industry Participation (Demand-side Bidding and Forecasting) Code Amendment 2011.

Clause 13.101(1)(c): revoked, on 29 June 2017, by clause 38(2) of the Electricity Industry Participation Code Amendment (Shortened Gate Closure and Revised Bid and Offer Provisions) 2017.

Clause 13.101(2): revoked, on 29 June 2017, by clause 38(3) of the Electricity Industry Participation Code Amendment (Shortened Gate Closure and Revised Bid and Offer Provisions) 2017.

13.102 Reporting obligations of system operator

By the 10th **business day** of each calendar month, the **system operator** must inform the **Authority** in writing of any discretionary action the **system operator** has taken under clause 13.70, in the previous calendar month, that required departure from the **dispatch schedule**.

Compare: Electricity Governance Rules 2003 rule 9 section III part G.

Clause 13.102(1)(b): amended, on 28 June 2012, by clause 45 of the Electricity Industry Participation (Demand-side Bidding and Forecasting) Code Amendment 2011.

Clause 13.102(1)(d): amended, on 1 February 2016, by clause 83 of the Electricity Industry Participation Code Amendment (Code Review Programme) 2015.

Clause 13.102: substituted, on 19 May 2016, by clause 32 of the Electricity Industry Participation Code Amendment (System Operator and Alignment with Statutory Objective) 2016.

System operator to provide and make information available

Cross Heading: amended, on 1 November 2022, by clause 57 of the Electricity Industry Participation Code Amendment (Real Time Pricing) 2022.

13.103 *[Revoked]*

Clause 13.103: revoked, on 28 June 2012, by clause 46 of the Electricity Industry Participation (Demand-side Bidding and Forecasting) Code Amendment 2011.

13.104 System operator to make information available

- (1) As soon as practicable after the **system operator** has completed preparing a **price-responsive schedule** and a **non-response schedule**, the **system operator** must make available on **WITS**, for each **trading period** in the **schedule length period**, the information specified in the table in Schedule 13.3B, as indicated by a X—
 - (a) in the case of the **price-responsive schedule**, in column 4 of the table; and
 - (b) in the case of the **non-response schedule**, in column 5 of the table.
- (2) Subclause (3) applies to—
 - (a) each **price-responsive schedule** prepared under clause 13.62(1)(a):
 - (b) each **non-response schedule** prepared under clause 13.62(1)(a).
- (3) Despite subclause (1), for each schedule to which this subclause applies, the **system operator** is not required to make available on **WITS** the information referred to in subclause (1) for the **trading periods** covered by—
 - (a) the **price-responsive schedule** prepared under clause 13.62(1)(b):
 - (b) the **non-response schedule** prepared under clause 13.62(1)(b).

Compare: Electricity Governance Rules 2003 rule 10.2 section III part G

Clause 13.104 Heading: replaced, on 5 October 2017, by clause 375(1) of the Electricity Industry Participation Code Amendment (Code Review Programme) 2017.

Clause 13.104: substituted, on 28 June 2012, by clause 47 of the Electricity Industry Participation (Demand-side Bidding and Forecasting) Code Amendment 2011.

Clause 13.104(1): replaced, on 1 November 2022, by clause 58(1) of the Electricity Industry Participation Code Amendment (Real Time Pricing) 2022.

Clause 13.104(1)(a)(iii): amended, at 12.00 pm on 19 September 2019, by clause 22 of the Electricity Industry Participation Code Amendment (Wind Offer Arrangements) 2019.

Clause 13.104(1) and (1)(a)(iv): amended, on 5 October 2017, by clause 375(2) of the Electricity Industry Participation Code Amendment (Code Review Programme) 2017.

Clause 13.104(1)(a)(x): revoked, on 1 November 2012, by clause 8(1) of the Electricity Industry Participation (Part 13 Minor Amendments) Code Amendment 2012.

Clause 13.104(1)(a)(xvi) and (xvii): inserted, on 1 June 2013, by clause 7 of the Electricity Industry Participation (Scarcity Pricing) Code Amendment 2011.

Clause 13.104(1)(a) & (b): amended, on 15 May 2014, by clause 41 of the Electricity Industry Participation (Modified Dispatchable Demand) Code Amendment 2013.

Clause 13.104(1)(c): inserted, on 1 November 2012, by clause 8(2) of the Electricity Industry Participation (Part 13 Minor Amendments) Code Amendment 2012.

Clause 13.104(1)(c): amended, on 3 October 2013, by clause 9 of the Electricity Industry Participation (Technology Neutral Language in Frequency Keeping) Code Amendment 2013.

Clause 13.104(3): amended, on 5 October 2017, by clause 375(3) of the Electricity Industry Participation Code Amendment (Code Review Programme) 2017.

Clause 13.104(3): amended, on 1 November 2022, by clause 58(2) of the Electricity Industry Participation Code Amendment (Real Time Pricing) 2022.

13.104A System operator to make information available in respect of dispatch schedule

The **system operator** must, each time the **system operator** implements a **dispatch schedule**, make available on **WITS** the information specified in the table in Schedule 13.3B, as indicated by a X in column 6 of the table.

Clause 13.104A: inserted, on 1 November 2022, by clause 59 of the Electricity Industry Participation Code Amendment (Real Time Pricing) 2022.

13.105 [Revoked]

Clause 13.105: revoked, on 28 June 2012, by clause 48 of the Electricity Industry Participation (Demand-side Bidding and Forecasting) Code Amendment 2011.

13.105A Information to be made available to purchasers, generators, and ancillary service agents

- (1) At the same time as the **system operator** is required to make information available in accordance with clause 13.104(1), the **system operator** must make available on **WITS**—
 - (aa) for each **dispatchable load purchaser** that has submitted a **nominated dispatch bid**, information from the current **non-response schedule** relating to the scheduling of the **dispatchable load purchaser's nominated dispatch bids** for the **trading periods** covered in the **schedule length period**; and
 - (a) for each **purchaser**, information from the current **price-responsive schedule** relating to the scheduling of the **purchaser's bids** for the **trading periods** covered in the **schedule length period**; and
 - (b) for each **generator**, information from the current **price-responsive schedule** and **non-response schedule** relating to the scheduling of the **generator's offers** for the **trading periods** covered in the **schedule length period**; and
 - (c) for each **ancillary service agent** who has submitted a **reserve offer** for the **scheduling period**, information from the current **price-responsive schedule** and **non-response schedule** relating to the scheduling of the **ancillary service agent's reserve offers** for the **trading periods** covered in the **schedule length period**.
- (2) Subclause (3) applies to—
 - (a) each **price-responsive schedule** prepared under clause 13.62(1)(a):
 - (b) each **non-response schedule** prepared under clause 13.62(1)(a).
- (3) Despite subclause (1), for each schedule to which this subclause applies, the **system operator** is not required to make available on **WITS** the information set out in subclause (1) for the **trading periods** covered by—
 - (a) the **price-responsive schedule** prepared under clause 13.62(1)(b):
 - (b) the **non-response schedule** prepared under clause 13.62(1)(b).

Clause 13.105A Heading: amended, on 5 October 2017, by clause 376(1) of the Electricity Industry Participation Code Amendment (Code Review Programme) 2017.

Clause 13.105A: inserted, on 28 June 2012, by clause 49 of the Electricity Industry Participation (Demand-side Bidding and Forecasting) Code Amendment 2011.

Clause 13.105A(1): amended, on 5 October 2017, by clause 376(2) of the Electricity Industry Participation Code Amendment (Code Review Programme) 2017.

Clause 13.105A(1): amended, on 1 November 2022, by clause 60 of the Electricity Industry Participation Code Amendment (Real Time Pricing) 2022.

Clause 13.105A(1)(aa): inserted, on 15 May 2014, by clause 42 of the Electricity Industry Participation (Modified Dispatchable Demand) Code Amendment 2013.

Clause 13.105A(3): amended, on 5 October 2017, by clause 376(3) of the Electricity Industry Participation Code Amendment (Code Review Programme) 2017.

13.106 Transmission of information

- (1) *[Revoked]*
- (2) If **WITS** is unavailable for the purposes of making information available under clauses 13.104 to 13.105A, the **system operator** must follow the backup procedures specified by the **WITS manager**.
- (3) The **WITS manager** must specify the backup procedures referred to in subclause (2) following consultation with the **Authority**, the **system operator**, the **clearing manager**, **purchasers**, **generators**, and **ancillary service agents**.

Compare: Electricity Governance Rules 2003 rules 10.5 to 10.7 section III part G
Clause 13.106 Heading: amended, on 5 October 2017, by clause 377(1) of the Electricity Industry Participation Code Amendment (Code Review Programme) 2017.
Clause 13.106(1): amended, on 28 June 2012, by clause 50 of the Electricity Industry Participation (Demand-side Bidding and Forecasting) Code Amendment 2011.
Clause 13.106(1): revoked, on 5 October 2017, by clause 377(2)(a) of the Electricity Industry Participation Code Amendment (Code Review Programme) 2017.
Clause 13.106(2) and (3): replaced, on 5 October 2017, by clause 377(2)(b) of the Electricity Industry Participation Code Amendment (Code Review Programme) 2017.
Clause 13.106(3): amended, on 1 November 2022, by clause 61 of the Electricity Industry Participation Code Amendment (Real Time Pricing) 2022.

Subpart 3—Must-run dispatch auction

13.107 Contents of this subpart

This subpart provides for must-run dispatch **auctions**.

Compare: Electricity Governance Rules 2003 rule 1 section IV part G

13.108 Clearing manager to hold must-run dispatch auctions

Each day the **clearing manager** must hold an **auction** as set out in clauses 13.117 to 13.130, at which **generators** may bid for **auction rights** in **time blocks**.

Compare: Electricity Governance Rules 2003 rule 2 section IV part G

13.109 Clearing manager authorises generators

- (1) If a **generator's** bid at an **auction** is successful the **clearing manager** must authorise the **generator** to **offer electricity** at 0 price for the relevant **time block** and **trading period**.
- (2) The **clearing manager** must specify in each authorisation—
 - (a) the quantity of **electricity** that the **generator** may offer under the authorisation; and
 - (b) the **trading periods** for which the authorisation is valid; and
 - (c) how much the **generator** must pay the **clearing manager** for the **auction rights**.

Compare: Electricity Governance Rules 2003 rules 2.1 and 2.2 section IV part G

13.110 Clearing manager must calculate amounts owing

- (1) The **clearing manager** must calculate the amount owing by each **generator** for the **auction rights** the **generator** has acquired in the previous **billing period**.
- (2) Any **auction revenue** owing by a **generator** in relation to a **billing period** must be advised to the **generator** by the **clearing manager** under subpart 4 of Part 14.

Compare: Electricity Governance Rules 2003 rules 2.3 and 2.4 section IV part G

Clause 13.110 heading: amended, on 24 March 2015, by clause 9(1) of the Electricity Industry Participation (Settlement and Prudential Security) Code Amendment 2013.

Clause 13.110: amended, on 24 March 2015, by clause 9(2) of the Electricity Industry Participation (Settlement and Prudential Security) Code Amendment 2013.

13.111 Purchasers must receive auction revenue

Each **purchaser** who purchases **electricity** at a **grid exit point** must receive **auction revenue** from **generators** in accordance with clause 13.112(1).

Compare: Electricity Governance Rules 2003 rule 2.5 section IV part G

13.112 Clearing manager must calculate amounts receivable

- (1) The **clearing manager** must calculate and credit **purchasers** for **auction revenue** for each **trading period** in accordance with the following formula:

$$AR_p = (TAR_g/APB)*(P_q/TP_q)$$

where

- AR_p is the **auction revenue** receivable by a **purchaser**
- TAR_g is the **total auction revenue** for a **time block** owing by **generators** as calculated by the **clearing manager** in accordance with clause 13.110(1)
- APB is the number of **trading periods** in that **time block**
- P_q is the total **electricity** purchased by that **purchaser** from the **clearing manager** during the **trading period** as shown by the **reconciliation information** calculated by the **reconciliation manager** under clause 15.21 to 15.26
- TP_q is the total **electricity** purchased by all **purchasers** from the **clearing manager** during the **trading period** as shown by **reconciliation information** calculated by the **reconciliation manager** under clause 15.21 to 15.26.

- (2) Any **auction revenue** owing to a **purchaser** in relation to a **billing period** must be advised to the **purchaser** by the **clearing manager** under subpart 4 of Part 14.

Compare: Electricity Governance Rules 2003 rules 2.6 and 2.7 section IV part G

Clause 13.112: amended, on 24 March 2015, by clause 10 of the Electricity Industry Participation (Settlement and Prudential Security) Code Amendment 2013.

13.113 Generators choose grid injection points at which they will exercise rights conferred

A **generator** who acquires **auction rights** may exercise them in respect of any **generating plant** it owns and at a **grid injection point** during the relevant **time block**.

Compare: Electricity Governance Rules 2003 rule 2.8 section IV part G

13.114 Transmission of auction information

- (1) Except where specified otherwise in this Part, all information in relation to **auctions** must be transmitted using **WITS**.
- (2) If **WITS** is not available to transmit information under this clause, the **clearing manager** must follow the backup procedures specified by the **WITS manager**.
- (3) The **WITS manager** must specify the backup procedures referred to in subclause (2) following consultation with the **Authority**, **generators**, and the **clearing manager**.

Compare: Electricity Governance Rules 2003 rules 2.9 to 2.11 section IV part G

Clause 13.114 Heading: amended, on 1 February 2016, by clause 84(1) of the Electricity Industry Participation Code Amendment (Code Review Programme) 2015.

Clause 13.114(1): substituted, on 1 February 2016, by clause 84(2) of the Electricity Industry Participation Code Amendment (Code Review Programme) 2015.

Clause 13.114: replaced, on 5 October 2017, by clause 378 of the Electricity Industry Participation Code Amendment (Code Review Programme) 2017.

13.115 Trading in auction rights permitted

- (1) A **generator** who has acquired **auction rights** at an **auction** (the "transferring generator") may transfer all or some of those rights to another **generator**.
- (2) The **generator** who acquires the rights by transfer takes them on the same terms that apply to the transferring generator.
- (3) A **generator** may transfer its rights by transferring, selling, assigning, or otherwise disposing of its ownership interest.

Compare: Electricity Governance Rules 2003 rule 2.12 section IV part G

Clause 13.115(1): amended, on 20 December 2021, by clause 58(1) of the Electricity Industry Participation Code Amendment (Code Review Programme) 2019.

Clause 13.115(2): amended, on 20 December 2021, by clause 58(2) of the Electricity Industry Participation Code Amendment (Code Review Programme) 2019.

Clause 13.115(3): inserted, on 20 December 2021, by clause 58(3) of the Electricity Industry Participation Code Amendment (Code Review Programme) 2019.

13.116 Offers at 0

- (1) Subject to subclause (2), a **generator** may offer **electricity** to the **clearing manager** at a 0 price only if the **generator** has an authorisation from an **auction** in accordance with clauses 13.108 to 13.115.
- (2) A **generator** may offer **electricity** to the **clearing manager** at a 0 price without an authorisation from an **auction** only in relation to—
 - (a) generating **plant** that comes within the scope of clauses 13.24 or 13.26; or
 - (b) **offers** submitted before publication of **auction** results, but, if authorisation from an **auction** is not granted, such **offers** are cancelled or revised so that they no longer contain a 0 price before 1300 hours on the day before the **trading day** for which the **offers** apply.

Compare: Electricity Governance Rules 2003 rules 2.13 and 2.14 section IV part G

Must-run auction process

13.117 Clearing manager must conduct auctions

- (1) The **clearing manager** must conduct an **auction** every day.
- (2) Each **generator** is eligible to take part in each **auction**.
- (3) The **clearing manager** must specify the format for bidding and must accept **auction bids** only if they are made in that format. Each **auction bid** must be made in positive numbers.

Compare: Electricity Governance Rules 2003 rules 3.1 to 3.3 section IV part G

13.118 [Revoked]

Compare: Electricity Governance Rules 2003 rule 3.4 section IV part G

Clause 13.118: revoked, on 1 February 2016, by clause 85 of the Electricity Industry Participation Code Amendment (Code Review Programme) 2015.

13.119 Historic load data

- (1) Subject to subclause (3), by 1100 hours on a day that is 2 days before an **auction**, a **grid owner** must advise the **clearing manager** of the information described in subclause (2) by—
 - (a) giving written notice to the **clearing manager**; or
 - (b) using **WITS**.
- (2) The information is the total load that was on the **grid** that is owned or operated by the **grid owner**, on the day that is 363 days before the date of the **auction**.
- (3) If the **trading day** following the **auction** is—
 - (a) a **national holiday**, the day referred to in subclause (2) is deemed to be the Sunday before the day preceding the date of the **auction** by 363 days; or
 - (b) a **business day**, but the 363rd day before the date of the **auction** is a **national holiday**, the day referred to in subclause (2) is deemed to be the next **business day** after the **national holiday**.

Compare: Electricity Governance Rules 2003 rule 3.5 section IV part G
Clause 13.119: replaced, on 5 October 2017, by clause 379 of the Electricity Industry Participation Code Amendment (Code Review Programme) 2017.

13.120 Quantity available for auction

The **clearing manager** must calculate the quantity of **auction rights** available in each **time block** at each **auction** as follows:

$$\text{quantity of auction rights available in each time block} = 0.8 \cdot \text{ldf}_{\text{tb}}$$

where

ldf_{tb} is the lowest demand forecast for a **time block**, which is the lowest demand in any **trading period** on the day for which load must be advised under clause 13.119 (in an interval that equates to the **time block**)

Compare: Electricity Governance Rules 2003 rule 3.6 section IV part G
Clause 13.120: amended, on 5 October 2017, by clause 380 of the Electricity Industry Participation Code Amendment (Code Review Programme) 2017.

13.121 Notice of auction and deadline for auction bids

- (1) For each **auction**, by any time up to 1100 hours on the day before the **auction**, the **clearing manager** must give written notice or use **WITS** to advise each **generator** of the quantity of **auction rights** available in each **time block** at the **auction** to be held the following day and must invite **auction bids** for those **auction rights**.
- (2) A **generator** who wishes to bid at an **auction** must submit **auction bids** by 0900 hours on the day that the **auction** is to be held.

Compare: Electricity Governance Rules 2003 rule 3.7 section IV part G
Clause 13.121(1): amended, on 5 October 2017, by clause 381 of the Electricity Industry Participation Code Amendment (Code Review Programme) 2017.

13.122 Revising, cancelling and extending auction bids

- (1) A **generator** may, by giving written notice or using **WITS**, revise or cancel an **auction bid** up to 0900 hours on the day of the **auction** to which the **auction bid** relates.

- (2) Each **auction bid** is valid for only 1 **auction** unless the **generator** expressly states when it makes the **auction bid** that the **auction bid** is to remain valid until cancelled.

Compare: Electricity Governance Rules 2003 rule 3.8 section IV part G

Clause 13.122(1): amended, on 5 October 2017, by clause 382 of the Electricity Industry Participation Code Amendment (Code Review Programme) 2017.

13.123 Contents of auction bids

- (1) A **generator** may make up to 5 **auction bids** for each **time block**.
- (2) Each **auction bid** must specify for each **time block** the quantity of **auction rights** sought and the price that the **generator** is prepared to pay if its **auction bid** succeeds.

Compare: Electricity Governance Rules 2003 rule 3.9 section IV part G

13.124 Ranking of auction bids

- (1) When bidding closes at 0900 hours each day the **clearing manager** must rank the **auction bids** it has received in descending order by price per **MWh**.
- (2) Beside each **auction bid** the **clearing manager** must record the quantity of **auction rights** sought by the relevant **generator**.

Compare: Electricity Governance Rules 2003 rule 3.10 section IV part G

13.125 Matching auction bids to rights

- (1) The **clearing manager** must match the ranked **auction bids** against all the **auction rights** available in each **time block** until the **auction bids** equal the quantity of **auction rights** available.
- (2) The **auction bids** made by a **generator** succeed if the bids are matched (in whole or part) against the **auction rights** available.

Compare: Electricity Governance Rules 2003 rule 3.11 section IV part G

13.126 Similar and identical auction bids

- (1) If the **clearing manager** receives more than 1 **auction bid** at the same price, and there are not enough **auction rights** available to satisfy the **auction bids**, the **clearing manager** must award **auction rights** to each relevant bidder in the order in which the **clearing manager** received the **auction bids** (as evidenced by the time stamp provided by the **clearing manager**'s computer system).
- (2) If the **clearing manager** receives more than 1 **auction bid** at the same price at the same time it will award **auction rights** to each relevant bidder in proportion to the volume of **auction rights** the bidders sought in each of their **auction bids**.

Compare: Electricity Governance Rules 2003 rule 3.12 section IV part G

13.127 Auction payment

The amount owing by a successful bidder in an **auction** is the quantity of **electricity** awarded by the **clearing manager** to that bidder multiplied by the **clearing auction price**.

Compare: Electricity Governance Rules 2003 rule 3.13 section IV part G

Clause 13.127: amended, on 24 March 2015, by clause 11 of the Electricity Industry Participation (Settlement and Prudential Security) Code Amendment 2013.

13.128 Results

By 1100 hours on the day of each **auction** the **clearing manager** must give written notice or use **WITS** to advise—

- (a) each **generator** that has bid at an **auction** of the outcome of the **auction**; and
- (b) all **generators** and **purchasers** of the quantity and price of all successful **auction bids** made at the **auction**.

Compare: Electricity Governance Rules 2003 rule 3.14 section IV part G
Clause 13.128: amended, on 5 October 2017, by clause 383 of the Electricity Industry Participation Code Amendment (Code Review Programme) 2017.

13.129 Authorisation to successful bidders

The **clearing manager** must give an authorisation, by way of a written notice or using **WITS**, to each **generator** that secures **auction rights** at an **auction**. The authorisation must set out the **auction rights** the **generators** secured at the **auction** and the price payable for them.

Compare: Electricity Governance Rules 2003 rule 3.15 section IV part G
Clause 13.129: amended, on 5 October 2017, by clause 384 of the Electricity Industry Participation Code Amendment (Code Review Programme) 2017.

13.130 Records

The **clearing manager** must maintain a complete record for 3 years of all quantities of **auction rights** offered, all **auction bids** received, and the prices achieved in each **time block** at each **auction**. A **generator** may require the **clearing manager** to provide, in writing or using **WITS**, information relating to the **generator's auction bids** and **auction** results at any time within that period.

Compare: Electricity Governance Rules 2003 rule 3.16 section IV part G
Clause 13.130: amended, on 5 October 2017, by clause 385 of the Electricity Industry Participation Code Amendment (Code Review Programme) 2017.

Subpart 4—Pricing

13.131 Contents of this subpart

This subpart provides for the processes by which—

- (a) the **clearing manager** prepares and makes available on **WITS interim prices** and **interim reserve prices**; and
- (b) **interim prices** and **interim reserve prices** become **final prices** and **final reserve prices**.

Compare: Electricity Governance Rules 2003 rule 1 section V part G
Clause 13.131: replaced, on 1 November 2022, by clause 62 of the Electricity Industry Participation Code Amendment (Real Time Pricing) 2022.

13.132 *[Revoked]*

Compare: Electricity Governance Rules 2003 rule 2 section V part G
Clause 13.132(a): amended, on 1 June 2013, by clause 8 of the Electricity Industry Participation (Scarcity Pricing) Code Amendment 2011.
Clause 13.132(b): replaced, on 5 October 2017, by clause 386 of the Electricity Industry Participation Code Amendment (Code Review Programme) 2017.
Clause 13.132: revoked, on 1 November 2022, by clause 63 of the Electricity Industry Participation Code Amendment (Real Time Pricing) 2022.

13.133 [Revoked]

Compare: Electricity Governance Rules 2003 rule 2A section V part G
Clause 13.133: revoked, on 1 November 2022, by clause 64 of the Electricity Industry Participation Code Amendment (Real Time Pricing) 2022.

13.134 [Revoked]

Compare: Electricity Governance Rules 2003 rule 2B section V part G
Clause 13.134(2): substituted, on 23 December 2011, by clause 4 of the Electricity Industry Participation (High Spring Washer Price Situation) Code Amendment 2011.
Clause 13.134(2A) and (2B): inserted, on 23 December 2011, by clause 4 of the Electricity Industry Participation (High Spring Washer Price Situation) Code Amendment 2011.
Clause 13.134(1): amended, on 21 September 2012, by clause 5(1) of the Electricity Industry Participation (High Spring Washer Price Situation) Code Amendment 2012.
Clause 13.134(2): substituted, on 21 September 2012, by clause 5(2) of the Electricity Industry Participation (High Spring Washer Price Situation) Code Amendment 2012.
Clause 13.134(2A), (2B) and (3): revoked, on 21 September 2012, by clause 5(2) of the Electricity Industry Participation (High Spring Washer Price Situation) Code Amendment 2012.
Clause 13.134(4), (5) and (6): inserted, on 21 September 2012, by clause 5(2) of the Electricity Industry Participation (High Spring Washer Price Situation) Code Amendment 2012.
Clause 13.134: revoked, on 1 November 2022, by clause 65 of the Electricity Industry Participation Code Amendment (Real Time Pricing) 2022.

Rules governing the preparation of interim prices

Cross Heading: amended, on 1 November 2022, by clause 66 of the Electricity Industry Participation Code Amendment (Real Time Pricing) 2022.

13.134A Methodology for calculating interim prices

The **clearing manager** must calculate **interim prices** and **interim reserve prices** for a **trading period** in accordance with the following formula:

$$I = \frac{\sum_{t=1}^n P_t \times (T_{t+1} - T_t)}{1800}$$

where

- I is the **interim price** or **interim reserve price**
- t is the sequential number of a **dispatch price** or **dispatch reserve price** in the set *n* in the **trading period**
- n is the total number of **dispatch prices** or **dispatch reserve prices** that apply during the **trading period**
- P_t is the **dispatch price** or **dispatch reserve price** as made available on WITS that applies for the **trading period** at time T_t
- T_t is the start time of the sequential numbered *t* **dispatch price** or **dispatch reserve price** for the **trading period**, as made available on WITS

but

if there is no **dispatch price** or **dispatch reserve price** for *t* = 1 in a **trading period**, the **dispatch price** or **dispatch reserve price** (as the case may be) for the *t* = 1 period is the

forecast price or forecast reserve price in the most recent price-responsive schedule received by the clearing manager prior to the start of the trading period.

Clause 13.134A: inserted, on 1 November 2022, by clause 67 of the Electricity Industry Participation Code Amendment (Real Time Pricing) 2022.

13.135 *[Revoked]*

Compare: Electricity Governance Rules 2003 rule 3.1 section V part G

Clause 13.135: amended, on 1 June 2013, by clause 9 of the Electricity Industry Participation (Scarcity Pricing) Code Amendment 2011.

Clause 13.135: revoked, on 1 November 2022, by clause 68 of the Electricity Industry Participation Code Amendment (Real Time Pricing) 2022.

13.135A *[Revoked]*

Clause 13.135A: inserted, on 1 June 2013, by clause 10 of the Electricity Industry Participation (Scarcity Pricing) Code Amendment 2011.

Clause 13.135A(1): amended, on 5 October 2017, by clause 387(a) of the Electricity Industry Participation Code Amendment (Code Review Programme) 2017.

Clause 13.135A(2A): inserted, on 19 January 2017, by clause 5(1) of the Electricity Industry Participation Code Amendment (Scarcity Pricing) 2016.

Clause 13.135A(5)(a): replaced, on 5 October 2017, by clause 387(b) of the Electricity Industry Participation Code Amendment (Code Review Programme) 2017.

Clause 13.135A(6): inserted, on 19 January 2017, by clause 5(2) of the Electricity Industry Participation Code Amendment (Scarcity Pricing) 2016.

Clause 13.135A(6): amended, on 5 October 2017, by clause 387(c) of the Electricity Industry Participation Code Amendment (Code Review Programme) 2017.

Clause 13.135A: revoked, on 1 November 2022, by clause 69 of the Electricity Industry Participation Code Amendment (Real Time Pricing) 2022.

13.135B *[Revoked]*

Clause 13.135B: inserted, on 1 June 2013, by clause 10 of the Electricity Industry Participation (Scarcity Pricing) Code Amendment 2011.

Clause 13.135B(b)(ii): amended, on 19 January 2017, by clause 6(1) of the Electricity Industry Participation Code Amendment (Scarcity Pricing) 2016.

Clause 13.135B(1)(b): replaced, on 5 October 2017, by clause 388(1) of the Electricity Industry Participation Code Amendment (Code Review Programme) 2017.

Clause 13.135B(2): amended, on 5 October 2017, by clause 388(2) of the Electricity Industry Participation Code Amendment (Code Review Programme) 2017.

Clause 13.135B(2) and (3): inserted, on 19 January 2017, by clause 6(2) of the Electricity Industry Participation Code Amendment (Scarcity Pricing) 2016.

Clause 13.135B(3)(b): amended, on 5 October 2017, by clause 388(3) of the Electricity Industry Participation Code Amendment (Code Review Programme) 2017.

Clause 13.135B: revoked, on 1 November 2022, by clause 70 of the Electricity Industry Participation Code Amendment (Real Time Pricing) 2022.

13.135C *[Revoked]*

Clause 13.135C: inserted, on 1 June 2013, by clause 10 of the Electricity Industry Participation (Scarcity Pricing) Code Amendment 2011.

Clause 13.135C: revoked, on 1 November 2022, by clause 71 of the Electricity Industry Participation Code Amendment (Real Time Pricing) 2022.

Generators to give grid owner half-hour metering information

Cross heading: amended, on 19 December 2014, by clause 27 of the Electricity Industry Participation Code Amendment (Minor Code Amendments) (No 3) 2014.

13.136 Offered embedded generators to provide half-hour metering information

- (1) Using an **approved system** or by written notice, each **generator** must give the relevant **grid owner half-hour metering information** under clause 13.138 in relation to **generating plant**—
- (a) that injects **electricity** directly into a **local network** or an **embedded network**; or
 - (b) if the **meter** configuration is such that the **electricity** flows into a **local network** without first passing through a **grid injection point** or **grid exit point metering installation**.
- (1A) For the purposes of subclause (1), the relevant **grid owner** is—
- (a) in relation to a **generator** (other than an **embedded generator**), the **grid owner** of the **grid** to which the **generator's generation** is connected; and
 - (b) in relation to a **generator** that is an **embedded generator**, the **grid owner** of the **grid** to which the **local network** to which the **embedded generator** is directly or indirectly connected, is connected.
- (2) Subclause (1) does not apply in respect of—
- (a) any **unoffered generation**; or
 - (b) *[Revoked]*
 - (c) a **dispatch notification generator**.

Compare: Electricity Governance Rules 2003 rule 3.2.1 section V part G

Clause 13.136 Heading: amended, at 12.00 pm on 19 September 2019, by clause 23(1) of the Electricity Industry Participation Code Amendment (Wind Offer Arrangements) 2019.

Clause 13.136(1): substituted, on 19 December 2014, by clause 28 of the Electricity Industry Participation Code Amendment (Minor Code Amendments) (No 3) 2014.

Clause 13.136(1): amended, on 5 October 2017, by clause 389(a) of the Electricity Industry Participation Code Amendment (Code Review Programme) 2017.

Clause 13.136(1): amended, at 12.00 pm on 19 September 2019, by clause 23(2) of the Electricity Industry Participation Code Amendment (Wind Offer Arrangements) 2019.

Clause 13.136(1A): inserted, on 19 December 2014, by clause 28 of the Electricity Industry Participation Code Amendment (Minor Code Amendments) (No 3) 2014.

Clause 13.136(1A): amended, on 23 February 2015, by clause 75 of the Electricity Industry Participation Code Amendment (Distributed Generation) 2014.

Clause 13.136(1A)(a) and (b): amended, on 5 October 2017, by clause 389(b) of the Electricity Industry Participation Code Amendment (Code Review Programme) 2017.

Clause 13.136(2): substituted, on 27 May 2015, by clause 10 of the Electricity Industry Participation Code Amendment (Industrial Co-generation Dispatch Arrangements) 2015.

Clause 13.136(2): amended, at 12.00 pm on 19 September 2019, by clause 23(3)(a) of the Electricity Industry Participation Code Amendment (Wind Offer Arrangements) 2019.

Clause 13.136(2)(b)(i): revoked, at 12.00 pm on 19 September 2019, by clause 23(3)(b) of the Electricity Industry Participation Code Amendment (Wind Offer Arrangements) 2019.

Clause 13.136(2)(b): revoked, on 1 November 2022, by clause 72(1) of the Electricity Industry Participation Code Amendment (Real Time Pricing) 2022.

Clause 13.136(2)(c): inserted, on 1 November 2022, by clause 72(2) of the Electricity Industry Participation Code Amendment (Real Time Pricing) 2022.

13.137 Unoffered grid-connected generators and grid-connected type B industrial co-generation to provide half-hour metering information

- (1) Using an **approved system** or by written notice, each **generator** must give the relevant **grid owner half-hour metering information** for—

- (a) **unoffered generation** from a **generating station** with a **point of connection to the grid**; and
 - (b) *[Revoked]*
 - (c) **electricity** supplied from a **type B industrial co-generating station** with a **point of connection to the grid**.
- (2) *[Revoked]*
- (3) If the **half-hour metering information** is not available, the **generator** must give the relevant **grid owner** a reasonable estimate of such data using an **approved system** or by written notice.

Compare: Electricity Governance Rules 2003 rule 3.2.2 section V part G

Clause 13.137 Heading: substituted, on 27 May 2015, by clause 11(1) of the Electricity Industry Participation Code Amendment (Industrial Co-generation Dispatch Arrangements) 2015.

Clause 13.137 Heading: amended, on 5 October 2017, by clause 390(1) of the Electricity Industry Participation Code Amendment (Code Review Programme) 2017.

Clause 13.137 Heading: replaced, at 12.00 pm on 19 September 2019, by clause 24(1) of the Electricity Industry Participation Code Amendment (Wind Offer Arrangements) 2019.

Clause 13.137: amended, on 19 December 2014, by clause 29 of the Electricity Industry Participation Code Amendment (Minor Code Amendments) (No 3) 2014.

Clause 13.137(1)(b): amended, on 27 May 2015, by clause 11(2) of the Electricity Industry Participation Code Amendment (Industrial Co-generation Dispatch Arrangements) 2015.

Clause 13.137(1)(b): revoked, at 12.00 pm on 19 September 2019, by clause 24(2) of the Electricity Industry Participation Code Amendment (Wind Offer Arrangements) 2019.

Clause 13.137(1)(c): inserted, on 27 May 2015, by clause 11(3) of the Electricity Industry Participation Code Amendment (Industrial Co-generation Dispatch Arrangements) 2015.

Clause 13.137 (1) and (3): amended, on 5 October 2017, by clause 390(2)(a) and (b) of the Electricity Industry Participation Code Amendment (Code Review Programme) 2017.

Clause 13.137(2): revoked, on 1 November 2022, by clause 73 of the Electricity Industry Participation Code Amendment (Real Time Pricing) 2022.

13.137A Offered grid-connected intermittent generators to provide half-hour metering information

- (1) Using an **approved system** or by written notice, each **intermittent generator** must, in relation to an **intermittent generating station** with a **point of connection to the grid**, give the relevant **grid owner half-hour metering information** for the **intermittent generating station**.
- (2) This clause does not apply to **unoffered generation**.
- (3) *[Revoked]*
- (4) If the **half-hour metering information** is not available, the **intermittent generator** must give the relevant **grid owner** a reasonable estimate of such data.

Clause 13.137A: inserted, at 12.00 pm on 19 September 2019, by clause 25 of the Electricity Industry Participation Code Amendment (Wind Offer Arrangements) 2019.

Clause 13.137A(3): revoked, on 1 November 2022, by clause 74 of the Electricity Industry Participation Code Amendment (Real Time Pricing) 2022.

13.138 Generator's half-hour metering information to be adjusted for losses

- (1) Each **generator** must provide the information required by clauses 13.136, 13.137, and 13.137A—
 - (a) adjusted for **losses** (if any) relative to the **grid injection point** or, for **embedded generators** the **grid exit point**, at which it offered the **electricity**; and
 - (b) in the manner and form that the relevant **grid owner** stipulates; and

- (c) by 1000 hours on a **trading day** for each **trading period** of the previous **trading day**.
- (2) To avoid doubt, each **generator** must provide the **half-hour metering information** required under this clause—
- (a) in accordance with the requirements of Part 15 for the collection of that **generator’s volume information**; or
- (b) from a source and in a manner agreed between the **generator** and the **grid owner**.
- Compare: Electricity Governance Rules 2003 rule 3.2.3 section V part G
Clause 13.138 Heading: amended, on 15 May 2014, by clause 43 of the Electricity Industry Participation (Modified Dispatchable Demand) Code Amendment 2013.
Clause 13.138(1): amended, at 12.00 pm on 19 September 2019, by clause 26 of the Electricity Industry Participation Code Amendment (Wind Offer Arrangements) 2019.
Clause 13.138(1)(b): amended, on 19 December 2014, by clause 30 of the Electricity Industry Participation Code Amendment (Minor Code Amendments) (No 3) 2014.
Clause 13.138(1)(c): amended, on 1 November 2022, by clause 75(1) of the Electricity Industry Participation Code Amendment (Real Time Pricing) 2022.
Clause 13.138(2): replaced, on 1 November 2022, by clause 75(2) of the Electricity Industry Participation Code Amendment (Real Time Pricing) 2022.

13.138A *[Revoked]*

Clause 13.138A: inserted, on 15 May 2014, by clause 44 of the Electricity Industry Participation (Modified Dispatchable Demand) Code Amendment 2013.
Clause 13.138A(1): amended, on 19 December 2014, by clause 31(1) of the Electricity Industry Participation Code Amendment (Minor Code Amendments) (No 3) 2014.
Clause 13.138A(1): amended, on 5 October 2017, by clause 391 of the Electricity Industry Participation Code Amendment (Code Review Programme) 2017.
Clause 13.138A(2)(b): amended, on 19 December 2014, by clause 31(2) of the Electricity Industry Participation Code Amendment (Minor Code Amendments) (No 3) 2014.
Clause 13.138A: revoked, on 1 November 2022, by clause 76 of the Electricity Industry Participation Code Amendment (Real Time Pricing) 2022.

13.138B *[Revoked]*

Clause 13.138B: inserted, on 15 May 2014, by clause 44 of the Electricity Industry Participation (Modified Dispatchable Demand) Code Amendment 2013.
Clause 13.138B: revoked, on 1 November 2022, by clause 77 of the Electricity Industry Participation Code Amendment (Real Time Pricing) 2022.

13.138C Generators to arrange for regular audits

Each **generator** with one or more obligations under clauses 13.136 to 13.138 of this Code must, in respect of these obligations,—

- (a) obtain and maintain **certification** under Schedule 15.1 to be permitted to perform, or to have performed by an agent or agents, any of these obligations; and
- (b) arrange to be **audited** regularly under Part 16A.

Clause 13.138C: inserted, on 1 March 2024, by clause 74 of the Electricity Industry Participation Code Amendment (Code Review Programme) 2024.

13.139 Half-hour metering information part of input information

The adjusted **half-hour metering information** provided under clauses 13.136 to 13.138 forms part of the input information in the formula in clause 13.141A.

Compare: Electricity Governance Rules 2003 rule 3.2.4 section V part G
Clause 13.139: substituted, on 19 December 2014, by clause 32 of the Electricity Industry Participation Code Amendment (Minor Code Amendments) (No 3) 2014.
Clause 13.139: amended, on 1 November 2022, by clause 78 of the Electricity Industry Participation Code Amendment (Real Time Pricing) 2022.

13.140 Generators to advise grid owner of having provided half-hour metering information

(1) *[Revoked]*

- (2) If a **generator** provides **half-hour metering information** to a **grid owner** under clauses 13.136 to 13.138, the **generator** must—
- (a) advise the relevant **grid owner** of this by 1000 hours on the day the **generator** provided the **half-hour metering information** to the relevant **grid owner**; and
 - (b) at the same time, advise the relevant **grid owner** if any of the **half-hour metering information** provided under clauses 13.136–13.137A is missing information, incorrect and/or estimated.

Compare: Electricity Governance Rules 2003 rule 3.2.5 section V part G

Clause 13.140 Heading: amended, on 5 October 2017, by clause 392 of the Electricity Industry Participation Code Amendment (Code Review Programme) 2017.

Clause 13.140 Heading: amended, on 1 November 2022, by clause 79(1) of the Electricity Industry Participation Code Amendment (Real Time Pricing) 2022.

Clause 13.140: substituted, on 15 May 2014, by clause 45 of the Electricity Industry Participation (Modified Dispatchable Demand) Code Amendment 2013.

Clause 13.140(1): revoked, on 1 November 2022, by clause 79(2) of the Electricity Industry Participation Code Amendment (Real Time Pricing) 2022.

Clause 13.140(2): substituted, on 19 December 2014, by clause 33 of the Electricity Industry Participation Code Amendment (Minor Code Amendments) (No 3) 2014.

Clause 13.140(2): replaced, on 1 November 2022, by clause 79(3) of the Electricity Industry Participation Code Amendment (Real Time Pricing) 2022.

13.140A Generators to resolve issues

If a **generator** cannot provide **half-hour metering information**, has provided incorrect **half-hour metering information**, or has provided estimated **half-hour metering information** under clauses 13.136–13.137A, the **generator** must, by 1200 hours on the 6th **business day** following the day the **generator** provided the **half-hour metering information** to the relevant **grid owner**,—

- (a) supply the missing information; or
- (b) replace incorrect information; or
- (c) replace estimated information with final information.

Clause 13.140(A): inserted, on 1 November 2022, by clause 80 of the Electricity Industry Participation Code Amendment (Real Time Pricing) 2022.

13.141 *[Revoked]*

Compare: Electricity Governance Rules 2003 rule 3.3 section V part G

Clause 13.141(1)(a) & (b): substituted, on 15 May 2014, by clause 46(a) of the Electricity Industry Participation (Modified Dispatchable Demand) Code Amendment 2013.

Clause 13.141(1)(b)(i): amended, on 19 December 2014, by clause 34(1) of the Electricity Industry Participation Code Amendment (Minor Code Amendments) (No 3) 2014.

Clause 13.141(1)(b)(i): amended, on 27 May 2015, by clause 12(1) of the Electricity Industry Participation Code Amendment (Industrial Co-generation Dispatch Arrangements) 2015.

Clause 13.141(1)(b)(i): replaced, at 12.00 pm on 19 September 2019, by clause 27(1) of the Electricity Industry Participation Code Amendment (Wind Offer Arrangements) 2019.

Clause 13.141(1)(b)(iii): amended, on 5 October 2017, by clause 393(a) of the Electricity Industry Participation Code Amendment (Code Review Programme) 2017.

Clause 13.141(1)(c): amended, on 27 May 2015, by clause 12(2) of the Electricity Industry Participation Code Amendment (Industrial Co-generation Dispatch Arrangements) 2015.

Clause 13.141(1)(caa): inserted, at 12.00 pm on 19 September 2019, by clause 27(2) of the Electricity Industry Participation Code Amendment (Wind Offer Arrangements) 2019.

Clause 13.141(1)(ca): inserted, on 15 May 2014, by clause 46(b) of the Electricity Industry Participation (Modified Dispatchable Demand) Code Amendment 2013.

Clause 13.141(1)(ca): amended, on 1 December 2015, by clause 6 of the Electricity Industry Participation Code Amendment (Dispatchable Demand: Late Bid Revisions) 2015.

Clause 13.141(1)(e): amended, on 15 May 2014, by clause 46(c) of the Electricity Industry Participation (Modified Dispatchable Demand) Code Amendment 2013.

Clause 13.141(1)(e): amended, on 5 October 2017, by clause 393(b) of the Electricity Industry Participation Code Amendment (Code Review Programme) 2017.

Clause 13.141(1AA): inserted, on 27 May 2015, by clause 12(3) of the Electricity Industry Participation Code Amendment (Industrial Co-generation Dispatch Arrangements) 2015.

Clause 13.141(1AA)(a): revoked, at 12.00 pm on 19 September 2019, by clause 27(3) of the Electricity Industry Participation Code Amendment (Wind Offer Arrangements) 2019.

Clause 13.141(1A): inserted, on 15 May 2014, by clause 46(d) of the Electricity Industry Participation (Modified Dispatchable Demand) Code Amendment 2013.

Clause 13.141(3): amended, on 5 October 2017, by clause 393(c) of the Electricity Industry Participation Code Amendment (Code Review Programme) 2017.

Clause 13.141(4): amended, on 19 December 2014, by clause 34(2) of the Electricity Industry Participation Code Amendment (Minor Code Amendments) (No 3) 2014.

Clause 13.141(4): amended, on 5 October 2017, by clause 393(d) of the Electricity Industry Participation Code Amendment (Code Review Programme) 2017.

Clause 13.141(5): amended, on 21 September 2012, by clause 22 of the Electricity Industry Participation (Minor Amendments) Code Amendment 2012.

Clause 13.141(5): amended, on 19 December 2014, by clause 34(3) of the Electricity Industry Participation Code Amendment (Minor Code Amendments) (No 3) 2014.

Clause 13.141(5): replaced, on 5 October 2017, by clause 393(e) of the Electricity Industry Participation Code Amendment (Code Review Programme) 2017.

Clause 13.141: revoked, on 1 November 2022, by clause 81 of the Electricity Industry Participation Code Amendment (Real Time Pricing) 2022.

13.141A Grid owner to calculate adjusted load information

- (1) A **grid owner** must calculate the adjusted load for each **point of connection** to the **grid** that is advised by the **clearing manager** under clause 13.141B(1) using the following formula:

$$AL = SG + (X_{grid} - I_{grid})$$

where

- AL is the adjusted load information
- SG is the generation information provided under clauses 13.136–13.138
- X_{grid} is the export from the **grid** at the **point of connection**
- I_{grid} is the injection into the **grid** at the **point of connection**

- (2) If there is no supplied generation then the adjusted load information will be the net flow at the **point of connection** as measured by the **grid owner**.
- (3) Where any of the inputs specified in subclause (1) are unavailable, the **grid owner** may estimate that input.

Clause 13.141A: inserted, on 1 November 2022, by clause 82 of the Electricity Industry Participation Code Amendment (Real Time Pricing) 2022.

13.141B Adjusted load information to be provided to the clearing manager

- (1) The **clearing manager** must advise a **grid owner** of the **points of connection** to the **grid** for which the **grid owner** must provide it with the adjusted load information.
- (2) A **grid owner** must use reasonable endeavours to provide the **clearing manager** with adjusted load information for the relevant **points of connection** to the **grid** advised by the **clearing manager** by 1200 hours on a **trading day** for each **trading period** on the previous **trading day**.
- (3) A **grid owner** and the **clearing manager** must agree the format and method of delivery for the adjusted load information.

Clause 13.141B: inserted, on 1 November 2022, by clause 82 of the Electricity Industry Participation Code Amendment (Real Time Pricing) 2022.

13.142 *[Revoked]*

Compare: Electricity Governance Rules 2003 rule 3.4 section V part G
Clause 13.142 Heading: amended, on 1 June 2013, by clause 11(1) of the Electricity Industry Participation (Scarcity Pricing) Code Amendment 2011.
Clause 13.142 Heading: replaced, on 5 October 2017, by clause 394(1) of the Electricity Industry Participation Code Amendment (Code Review Programme) 2017.
Clause 13.142(1): amended, on 1 June 2013, by clause 11(2) of the Electricity Industry Participation (Scarcity Pricing) Code Amendment 2011.
Clause 13.142(1): amended, on 5 October 2017, by clause 394(2) of the Electricity Industry Participation Code Amendment (Code Review Programme) 2017.
Clause 13.142(1)(b): amended, on 1 June 2011, by clause 5 of the Electricity Industry Participation (Minor Amendments) Code Amendment 2011.
Clause 13.142(2): amended, on 5 October 2017, by clause 394(3) of the Electricity Industry Participation Code Amendment (Code Review Programme) 2017.
Clause 13.142: revoked, on 1 November 2022, by clause 83 of the Electricity Industry Participation Code Amendment (Real Time Pricing) 2022.

13.143 *[Revoked]*

Compare: Electricity Governance Rules 2003 rule 3.5 section V part G
Clause 13.143 Heading: amended, on 5 October 2017, by clause 395(1) of the Electricity Industry Participation Code Amendment (Code Review Programme) 2017.
Clause 13.143(1), (3) and (4): amended, on 5 October 2017, by clause 395(2)(a) to (c) of the Electricity Industry Participation Code Amendment (Code Review Programme) 2017.
Clause 13.143(5): inserted, on 5 October 2017, by clause 395(2)(d) of the Electricity Industry Participation Code Amendment (Code Review Programme) 2017.
Clause 13.143: revoked, on 1 November 2022, by clause 84 of the Electricity Industry Participation Code Amendment (Real Time Pricing) 2022.

13.144 *[Revoked]*

Compare: Electricity Governance Rules 2003 rules 3.6 and 3.6A section V part G
Clause 13.144 Heading: amended, on 1 June 2013, by clause 12(1) of the Electricity Industry Participation (Scarcity Pricing) Code Amendment 2011.
Clause 13.144 Heading: amended, on 5 October 2017, by clause 396(1) of the Electricity Industry Participation Code Amendment (Code Review Programme) 2017.
Clause 13.144(1): amended, on 1 June 2013, by clause 12(2)(a) and (b) of the Electricity Industry Participation (Scarcity Pricing) Code Amendment 2011.
Clause 13.144(1): amended, on 19 January 2017, by clause 7(1) of the Electricity Industry Participation Code Amendment (Scarcity Pricing) 2016.
Clause 13.144(1)(a): replaced, on 5 October 2017, by clause 396(2)(a) of the Electricity Industry Participation Code Amendment (Code Review Programme) 2017.
Clause 13.144(1)(a) and (b): amended, on 1 June 2013, by clause 12(2)(c) of the Electricity Industry Participation (Scarcity Pricing) Code Amendment 2011.
Clause 13.144(1)(c): amended, on 1 June 2013, by clause 12(2)(d) of the Electricity Industry Participation (Scarcity Pricing) Code Amendment 2011.
Clause 13.144(1)(d): inserted, on 1 June 2013, by clause 12(2)(e) of the Electricity Industry Participation (Scarcity Pricing) Code Amendment 2011.
Clause 13.144(1A): inserted, on 19 January 2017, by clause 7(2) of the Electricity Industry Participation Code Amendment (Scarcity Pricing) 2016.
Clause 13.144(2): amended, on 1 June 2013, by clause 12(3) of the Electricity Industry Participation (Scarcity Pricing) Code Amendment 2011.
Clause 13.144(2), (3), (4) and (5): amended, on 5 October 2017, by clause 396(2)(b) and (c) and (3) of the Electricity Industry Participation Code Amendment (Code Review Programme) 2017.
Clause 13.144(3), (4) and (5): inserted, on 19 January 2017, by clause 7(3) of the Electricity Industry Participation Code Amendment (Scarcity Pricing) 2016.
Clause 13.144: revoked, on 1 November 2022, by clause 85 of the Electricity Industry Participation Code Amendment (Real Time Pricing) 2022.

13.145 Grid owner to give written notice that estimated data given

- (1) If a **grid owner** gives the **clearing manager** estimated adjusted load information or is unable to provide adjusted load information under clause 13.141B, the **grid owner** must, by the time specified in clause 13.141B(2),—
 - (a) give written notice to the **clearing manager** of any adjusted load information that is estimated or unable to be provided; and
 - (b) give details in the notice of the **grid exit points** and **grid injection points** to which the estimated information relates or is unable to be provided; and
 - (c) specify in the notice the **trading periods** for which the adjusted load information is estimated or unable to be provided for each relevant **grid exit point** and **grid injection point**.
- (2) Where a **grid owner** is unable to deliver the adjusted load information or the adjusted load information contains estimates, the **grid owner** will deliver or provide replacement information within 7 business days following the day the **generator** provided the **half-hour metering information** to the **grid owner**.

Compare: Electricity Governance Rules 2003 rule 3.7 section V part G

Clause 13.145 Heading: amended, on 5 October 2017, by clause 397(1) of the Electricity Industry Participation Code Amendment (Code Review Programme) 2017.

Clause 13.145(1)(a): amended, on 5 October 2017, by clause 397(2) of the Electricity Industry Participation Code Amendment (Code Review Programme) 2017.

Clause 13.145(1)(c): amended, on 19 December 2014, by clause 35(1) of the Electricity Industry Participation Code Amendment (Minor Code Amendments) (No 3) 2014.

Clause 13.145(1)(d) and (e): inserted, on 19 December 2014, by clause 35(2) of the Electricity Industry Participation Code Amendment (Minor Code Amendments) (No 3) 2014.

Clause 13.145(1)(d): amended, on 27 May 2015, by clause 13 of the Electricity Industry Participation Code Amendment (Industrial Co-generation Dispatch Arrangements) 2015.

Clause 13.145(2): inserted, on 5 October 2017, by clause 397(2)(b) of the Electricity Industry Participation Code Amendment (Code Review Programme) 2017.

Clause 13.145: replaced, on 1 November 2022, by clause 86 of the Electricity Industry Participation Code Amendment (Real Time Pricing) 2022.

13.146 *[Revoked]*

Compare: Electricity Governance Rules 2003 rule 3.8 section V part G

Clause 13.146 Heading: amended, on 1 June 2013, by clause 13(1) of the Electricity Industry Participation (Scarcity Pricing) Code Amendment 2011.

Clause 13.146(1) and (2): amended, on 5 October 2017, by clause 398(1) of the Electricity Industry Participation Code Amendment (Code Review Programme) 2017.

Clause 13.146(2A): inserted, on 1 June 2013, by clause 13(2) of the Electricity Industry Participation (Scarcity Pricing) Code Amendment 2011.

Clause 13.146(4): amended, on 15 May 2014, by clause 47 of the Electricity Industry Participation (Modified Dispatchable Demand) Code Amendment 2013.

Clause 13.146(4): amended, on 19 December 2014, by clause 36 of the Electricity Industry Participation Code Amendment (Minor Code Amendments) (No 3) 2014.

Clause 13.146(4): amended, on 5 October 2017, by clause 398(2) of the Electricity Industry Participation Code Amendment (Code Review Programme) 2017.

Clause 13.146: revoked, on 1 November 2022, by clause 87 of the Electricity Industry Participation Code Amendment (Real Time Pricing) 2022.

13.147 *[Revoked]*

Compare: Electricity Governance Rules 2003 rule 3.9 section V part G

Clause 13.147 Heading: amended, on 5 October 2017, by clause 399(1) of the Electricity Industry Participation Code Amendment (Code Review Programme) 2017.

Clause 13.147: substituted, on 15 May 2014, by clause 48 of the Electricity Industry Participation (Modified Dispatchable Demand) Code Amendment 2013.

Clause 13.147(1), (2) and (3): amended, on 5 October 2017, by clause 399(2)(a) and (b) of the Electricity Industry Participation Code Amendment (Code Review Programme) 2017.

Clause 13.147(1)(b) and (d): revoked, on 19 December 2014, by clause 37(1) of the Electricity Industry Participation Code Amendment (Minor Code Amendments) (No 3) 2014.

Clause 13.147(1)(c): amended, on 19 December 2014, by clause 37(2) of the Electricity Industry Participation Code Amendment (Minor Code Amendments) (No 3) 2014.

Clause 13.147(2)(a): replaced, on 5 October 2017, by clause 399(2)(c) of the Electricity Industry Participation Code Amendment (Code Review Programme) 2017.

Clause 13.147(4): inserted, on 5 October 2017, by clause 399(2)(d) of the Electricity Industry Participation Code Amendment (Code Review Programme) 2017.

Clause 13.147: revoked, on 1 November 2022, by clause 88 of the Electricity Industry Participation Code Amendment (Real Time Pricing) 2022.

13.148 *[Revoked]*

Compare: Electricity Governance Rules 2003 rule 3.10 section V part G

Clause 13.148: amended, on 15 May 2014, by clause 49 of the Electricity Industry Participation (Modified Dispatchable Demand) Code Amendment 2013.

Clause 13.148: revoked, on 1 November 2022, by clause 89 of the Electricity Industry Participation Code Amendment (Real Time Pricing) 2022.

13.149 *[Revoked]*

Compare: Electricity Governance Rules 2003 rule 3.11 section V part G

Clause 13.149 Heading: replaced, on 5 October 2017, by clause 400(1) of the Electricity Industry Participation Code Amendment (Code Review Programme) 2017.

Clause 13.149 Heading: amended, on 1 November 2018, by clause 88(1) of the Electricity Industry Participation Code Amendment (Code Review Programme) 2018.

Clause 13.149: amended, on 15 May 2014, by clause 50 of the Electricity Industry Participation (Modified Dispatchable Demand) Code Amendment 2013.

Clause 13.149(2)(a) and (b): amended, on 5 October 2017, by clause 400(2) of the Electricity Industry Participation Code Amendment (Code Review Programme) 2017.

Clause 13.149(2)(a) and (b): amended, on 1 November 2018, by clause 88(2)(a) and (b) of the Electricity Industry Participation Code Amendment (Code Review Programme) 2018.

Clause 13.149(2)(c): revoked, on 1 November 2018, by clause 88(2)(c) of the Electricity Industry Participation Code Amendment (Code Review Programme) 2018.

Clause 13.149: revoked, on 1 November 2022, by clause 90 of the Electricity Industry Participation Code Amendment (Real Time Pricing) 2022.

13.150 *[Revoked]*

Compare: Electricity Governance Rules 2003 rule 3.12 section V part G

Clause 13.150 Heading: replaced, on 5 October 2017, by clause 401(1) of the Electricity Industry Participation Code Amendment (Code Review Programme) 2017.

Clause 13.150: amended, on 15 May 2014, by clause 51 of the Electricity Industry Participation (Modified Dispatchable Demand) Code Amendment 2013.

Clause 13.150(2)(a) and (b): amended, on 5 October 2017, by clause 401(2) of the Electricity Industry Participation Code Amendment (Code Review Programme) 2017.

Clause 13.150(2)(a) and (b): amended, on 1 November 2018, by clause 89(a) and (b) of the Electricity Industry Participation Code Amendment (Code Review Programme) 2018.

Clause 13.150(2)(c): revoked, on 1 November 2018, by clause 89(c) of the Electricity Industry Participation Code Amendment (Code Review Programme) 2018.

Clause 13.150: revoked, on 1 November 2022, by clause 91 of the Electricity Industry Participation Code Amendment (Real Time Pricing) 2022.

13.151 *[Revoked]*

Compare: Electricity Governance Rules 2003 rule 3.13 section V part G

Clause 13.151: revoked, on 1 November 2022, by clause 92 of the Electricity Industry Participation Code Amendment (Real Time Pricing) 2022.

13.152 *[Revoked]*

Compare: Electricity Governance Rules 2003 rule 3.14 section V part G

Clause 13.152 Heading: amended, on 5 October 2017, by clause 402(1) of the Electricity Industry Participation Code Amendment (Code Review Programme) 2017.

Clause 13.152: substituted, on 15 May 2014, by clause 52 of the Electricity Industry Participation (Modified Dispatchable Demand) Code Amendment 2013.

Clause 13.152: amended, on 5 October 2017, by clause 402(2) of the Electricity Industry Participation Code Amendment (Code Review Programme) 2017.

Clause 13.152: revoked, on 1 November 2022, by clause 93 of the Electricity Industry Participation Code Amendment (Real Time Pricing) 2022.

13.153 *[Revoked]*

Compare: Electricity Governance Rules 2003 rule 3.15 section V part G

Clause 13.153: amended, on 5 October 2017, by clause 403 of the Electricity Industry Participation Code Amendment (Code Review Programme) 2017.

Clause 13.153: revoked, on 1 November 2022, by clause 94 of the Electricity Industry Participation Code Amendment (Real Time Pricing) 2022.

13.154 *[Revoked]*

Compare: Electricity Governance Rules 2003 rule 3.16 section V part G

Clause 13.154 Heading: amended, on 15 May 2014, by clause 53(a) of the Electricity Industry Participation (Modified Dispatchable Demand) Code Amendment 2013.

Clause 13.154 Heading: amended, on 5 October 2017, by clause 404(1) of the Electricity Industry Participation Code Amendment (Code Review Programme) 2017.

Clause 13.154(1): substituted, on 15 May 2014, by clause 53(b) of the Electricity Industry Participation (Modified Dispatchable Demand) Code Amendment 2013.

Clause 13.154(1): amended, on 5 October 2017, by clause 404(2) of the Electricity Industry Participation Code Amendment (Code Review Programme) 2017.

Clause 13.154(1A): inserted, on 15 May 2014, by clause 53(b) of the Electricity Industry Participation (Modified Dispatchable Demand) Code Amendment 2013.

Clause 13.154(1A): amended, on 5 October 2017, by clause 404(3) of the Electricity Industry Participation Code Amendment (Code Review Programme) 2017.

Clause 13.154(2): amended, on 15 May 2014, by clause 53(c) of the Electricity Industry Participation (Modified Dispatchable Demand) Code Amendment 2013.

Clause 13.154(2): amended, on 5 October 2017, by clause 404(4) of the Electricity Industry Participation Code Amendment (Code Review Programme) 2017.

Clause 13.154: revoked, on 1 November 2022, by clause 95 of the Electricity Industry Participation Code Amendment (Real Time Pricing) 2022.

13.155 *[Revoked]*

Compare: Electricity Governance Rules 2003 rule 3.17 section V part G

Clause 13.155 Heading: amended, on 5 October 2017, by clause 405(1) of the Electricity Industry Participation Code Amendment (Code Review Programme) 2017.

Clause 13.155: amended, on 15 May 2014, by clause 54 of the Electricity Industry Participation (Modified Dispatchable Demand) Code Amendment 2013.

Clause 13.155(1)(a): replaced, on 5 October 2017, by clause 405(2)(a) of the Electricity Industry Participation Code Amendment (Code Review Programme) 2017.

Clause 13.155(2): inserted, on 5 October 2017, by clause 405(2)(b) of the Electricity Industry Participation Code Amendment (Code Review Programme) 2017.

Clause 13.155: revoked, on 1 November 2022, by clause 96 of the Electricity Industry Participation Code Amendment (Real Time Pricing) 2022.

13.156 *[Revoked]*

Compare: Electricity Governance Rules 2003 rules 3.18 and 3.18A section V part G

Clause 13.156 Heading: replaced, on 5 October 2017, by clause 406(1) of the Electricity Industry Participation Code Amendment (Code Review Programme) 2017.

Clause 13.156(1): amended, on 5 October 2017, by clause 406(2) of the Electricity Industry Participation Code Amendment (Code Review Programme) 2017.

Clause 13.156(2): amended, on 5 October 2017, by clause 406(3) of the Electricity Industry Participation Code Amendment (Code Review Programme) 2017.

Clause 13.156: revoked, on 1 November 2022, by clause 97 of the Electricity Industry Participation Code Amendment (Real Time Pricing) 2022.

13.157 *[Revoked]*

Compare: Electricity Governance Rules 2003 rule 3.19 section V part G

Clause 13.157(1) and (2): amended, on 5 October 2017, by clause 407 of the Electricity Industry Participation Code Amendment (Code Review Programme) 2017.

Clause 13.157: revoked, on 1 November 2022, by clause 98 of the Electricity Industry Participation Code Amendment (Real Time Pricing) 2022.

13.158 *[Revoked]*

Compare: Electricity Governance Rules 2003 rule 3.20 section V part G

Clause 13.158 Heading: amended, on 5 October 2017, by clause 408(1) of the Electricity Industry Participation Code Amendment (Code Review Programme) 2017.

Clause 13.158(1)(a): replaced, on 5 October 2017, by clause 408(2)(a) of the Electricity Industry Participation Code Amendment (Code Review Programme) 2017.

Clause 13.158(2): inserted, on 5 October 2017, by clause 408(2)(b) of the Electricity Industry Participation Code Amendment (Code Review Programme) 2017.

Clause 13.158: revoked, on 1 November 2022, by clause 99 of the Electricity Industry Participation Code Amendment (Real Time Pricing) 2022.

13.159 *[Revoked]*

Compare: Electricity Governance Rules 2003 rule 3.21 section V part G

Clause 13.159 Heading: replaced, on 5 October 2017, by clause 409(1) of the Electricity Industry Participation Code Amendment (Code Review Programme) 2017.

Clause 13.159(a) and (b): amended, on 5 October 2017, by clause 409(2) of the Electricity Industry Participation Code Amendment (Code Review Programme) 2017.

Clause 13.159: revoked, on 1 November 2022, by clause 100 of the Electricity Industry Participation Code Amendment (Real Time Pricing) 2022.

13.160 *[Revoked]*

Compare: Electricity Governance Rules 2003 rule 3.21A section V part G

Clause 13.160: revoked, on 1 November 2022, by clause 101 of the Electricity Industry Participation Code Amendment (Real Time Pricing) 2022.

13.161 *[Revoked]*

Compare: Electricity Governance Rules 2003 rule 3.21B section V part G

Clause 13.161(1): amended, on 5 October 2017, by clause 410(1) of the Electricity Industry Participation Code Amendment (Code Review Programme) 2017.

Clause 13.161(2)(a): replaced, on 5 October 2017, by clause 410(2) of the Electricity Industry Participation Code Amendment (Code Review Programme) 2017.

Clause 13.161(3): inserted, on 5 October 2017, by clause 410(3) of the Electricity Industry Participation Code Amendment (Code Review Programme) 2017.

Clause 13.161: revoked, on 1 November 2022, by clause 102 of the Electricity Industry Participation Code Amendment (Real Time Pricing) 2022.

13.162 *[Revoked]*

Compare: Electricity Governance Rules 2003 rule 3.21C section V part G

Clause 13.162 Heading: amended, on 5 October 2017, by clause 411(1) of the Electricity Industry Participation Code Amendment (Code Review Programme) 2017.

Clause 13.162(a) and (b): amended, on 5 October 2017, by clause 411(2) of the Electricity Industry Participation Code Amendment (Code Review Programme) 2017.

Clause 13.162: revoked, on 1 November 2022, by clause 103 of the Electricity Industry Participation Code Amendment (Real Time Pricing) 2022.

13.163 *[Revoked]*

Compare: Electricity Governance Rules 2003 rule 3.22 section V part G

Clause 13.163: amended, on 5 October 2017, by clause 412 of the Electricity Industry Participation Code Amendment (Code Review Programme) 2017.

Clause 13.163: revoked, on 1 November 2022, by clause 104 of the Electricity Industry Participation Code Amendment (Real Time Pricing) 2022.

13.164 *[Revoked]*

Compare: Electricity Governance Rules 2003 rule 3.23 section V part G

Clause 13.164(a) to (d): amended, on 5 October 2017, by clause 413(a) to (d) of the Electricity Industry Participation Code Amendment (Code Review Programme) 2017.

Clause 13.164: revoked, on 1 November 2022, by clause 105 of the Electricity Industry Participation Code Amendment (Real Time Pricing) 2022.

13.165 *[Revoked]*

Compare: Electricity Governance Rules 2003 rules 3.24 and 3.25 section V part G

Clause 13.165 Heading: replaced, on 5 October 2017, by clause 414(1) of the Electricity Industry Participation Code Amendment (Code Review Programme) 2017.

Clause 13.165(1): amended, on 5 October 2017, by clause 414(2) of the Electricity Industry Participation Code Amendment (Code Review Programme) 2017.

Clause 13.165: revoked, on 1 November 2022, by clause 106 of the Electricity Industry Participation Code Amendment (Real Time Pricing) 2022.

13.166 *[Revoked]*

Compare: Electricity Governance Rules 2003 rule 3.26 section V part G

Clause 13.166 Heading: amended, on 15 May 2014, by clause 55 of the Electricity Industry Participation (Modified Dispatchable Demand) Code Amendment 2013.

Clause 13.166 (1) and (2): amended, on 15 May 2014, by clause 55 of the Electricity Industry Participation (Modified Dispatchable Demand) Code Amendment 2013.

Clause 13.166: revoked, on 1 November 2022, by clause 107 of the Electricity Industry Participation Code Amendment (Real Time Pricing) 2022.

13.166A *[Revoked]*

Clause 13.166A Heading: amended, on 5 October 2017, by clause 415(1) of the Electricity Industry Participation Code Amendment (Code Review Programme) 2017.

Clause 13.166A: inserted, on 1 June 2013, by clause 14 of the Electricity Industry Participation (Scarcity Pricing) Code Amendment 2011.

Clause 13.166A(1): amended, on 5 October 2017, by clause 415(2) of the Electricity Industry Participation Code Amendment (Code Review Programme) 2017.

Clause 13.166A: revoked, on 1 November 2022, by clause 108 of the Electricity Industry Participation Code Amendment (Real Time Pricing) 2022.

Publication of interim prices

Cross Heading: replaced, on 1 November 2022, by clause 109 of the Electricity Industry Participation Code Amendment (Real Time Pricing) 2022.

13.167 Clearing manager to make interim prices available

The clearing manager must make interim prices and interim reserve prices for a trading period available on WITS as soon as practicable after the end of that trading period.

Compare: Electricity Governance Rules 2003 rule 3.26A section V part G

Clause 13.167 Heading: amended, on 5 October 2017, by clause 416(1) of the Electricity Industry Participation Code Amendment (Code Review Programme) 2017.

Clause 13.167: amended, on 5 October 2017, by clause 416(2) of the Electricity Industry Participation Code Amendment (Code Review Programme) 2017.

Clause 13.167(aa): inserted, on 1 June 2013, by clause 15 of the Electricity Industry Participation (Scarcity Pricing) Code Amendment 2011.

Clause 13.167(c): amended, on 21 September 2012, by clause 23 of the Electricity Industry Participation (Minor Amendments) Code Amendment 2012.

Clause 13.167(c): amended, on 5 October 2017, by clause 416(3) of the Electricity Industry Participation Code Amendment (Code Review Programme) 2017.

Clause 13.167: replaced, on 1 November 2022, by clause 110 of the Electricity Industry Participation Code Amendment (Real Time Pricing) 2022.

Pricing error process

Cross Heading: inserted, on 1 November 2022, by clause 111 of the Electricity Industry Participation Code Amendment (Real Time Pricing) 2022.

13.168 When pricing error may be claimed or investigated

After the **clearing manager** makes an **interim price** or **interim reserve price** available on **WITS**, but before the relevant price has become a **final price** or **final reserve price** (as applicable),—

- (a) a person may make a **pricing error** claim to the **clearing manager** in respect of that price under clause 13.170; and
- (b) the clearing manager may investigate a potential pricing error in respect of that price under clause 13.170A.

Compare: Electricity Governance Rules 2003 rule 3.26B section V part G

Clause 13.168: amended, on 5 October 2017, by clause 417 of the Electricity Industry Participation Code Amendment (Code Review Programme) 2017.

Clause 13.168: replaced, on 1 November 2022, by clause 112 of the Electricity Industry Participation Code Amendment (Real Time Pricing) 2022.

13.169 [Revoked]

Compare: Electricity Governance Rules 2003 rule 3.26C section V part G

Clause 13.169: revoked, on 1 November 2022, by clause 113 of the Electricity Industry Participation Code Amendment (Real Time Pricing) 2022.

13.170 Method and timing for claiming pricing error has occurred

To claim that a **pricing error** has occurred, an error claimant must—

- (a) submit a **pricing error** claim to the **clearing manager** in such manner and form as the **clearing manager** may specify from time to time; and
- (b) include information in its claim to demonstrate—
 - (i) that, except where the error claimant is the **Authority** or **system operator**, the error claimant has been affected by the claimed **pricing error**; and
 - (ii) the basis for the claim that a **pricing error** has occurred; and
 - (iii) the **trading periods** affected by the claimed **pricing error**; and
- (c) comply with paragraphs (a) and (b) no later than 1200 hours on the 1st business day following the trading day on which the clearing manager made available on **WITS** the interim price or interim reserve price in respect of which the pricing error has been claimed.

Compare: Electricity Governance Rules 2003 rule 3.26D section V part G

Clause 13.170(b): amended, on 21 September 2012, by clause 24 of the Electricity Industry Participation (Minor Amendments) Code Amendment 2012.

Clause 13.170(c): replaced, on 5 October 2017, by clause 418(a) of the Electricity Industry Participation Code Amendment (Code Review Programme) 2017.

Clause 13.170(d): amended, on 5 October 2017, by clause 418(b) of the Electricity Industry Participation Code Amendment (Code Review Programme) 2017.

Clause 13.170: replaced, on 1 November 2022, by clause 114 of the Electricity Industry Participation Code Amendment (Real Time Pricing) 2022.

13.170A Clearing manager may investigate potential pricing errors

- (1) The **clearing manager** may investigate a potential **pricing error**.
- (2) If the **clearing manager** decides to investigate a potential **pricing error**, it must commence the investigation no later than 1200 hours on the 1st **business day** following the **trading day** on which the **clearing manager** made available on **WITS** the **interim price** or **interim reserve price** that is the subject of that investigation.

Clause 13.170A: inserted, on 1 November 2022, by clause 115 of the Electricity Industry Participation Code Amendment (Real Time Pricing) 2022.

13.171 *[Revoked]*

Compare: Electricity Governance Rules 2003 rule 3.26E section V part G
Clause 13.171: replaced, on 5 October 2017, by clause 419 of the Electricity Industry Participation Code Amendment (Code Review Programme) 2017.
Clause 13.171: revoked, on 1 November 2022, by clause 116 of the Electricity Industry Participation Code Amendment (Real Time Pricing) 2022.

13.172 *[Revoked]*

Compare: Electricity Governance Rules 2003 rule 3.26F section V part G
Clause 13.172: amended, on 5 October 2017, by clause 420 of the Electricity Industry Participation Code Amendment (Code Review Programme) 2017.
Clause 13.172: revoked, on 1 November 2022, by clause 117 of the Electricity Industry Participation Code Amendment (Real Time Pricing) 2022.

13.173 Process when pricing error claim received

- (1) If the **clearing manager** receives a **pricing error** claim submitted under clause 13.170 by the time prescribed by that clause, the **clearing manager** must, as soon as practicable,—
 - (a) check that the information required by that clause is included in the pricing error claim; and
 - (b) confirm to the error claimant that it has received the pricing error claim; and
 - (c) either—
 - (i) confirm to the error claimant that the **pricing error** claim contains the required information; or
 - (ii) if the required information is not contained in the **pricing error** claim, request that the error claimant provide the **clearing manager** with the required information.
- (2) The **clearing manager** must, no later than 1300 hours on the 1st **business day** following the **trading day** on which the **clearing manager** made available on **WITS** the **interim price** or **interim reserve price** in respect of which a **pricing error** has been claimed (with such **pricing error** claim having been submitted under clause 13.170 by the time prescribed by that clause), give a written notice on **WITS** and to the **Authority**, any person that has requested notice and the error claimant advising—
 - (a) that a **pricing error** has been claimed; and
 - (b) the name of the error claimant; and
 - (c) the reasons the error claimant has given for the claim that a **pricing error** has occurred; and
 - (d) the **trading periods** that the error claimant claims have been affected by the **pricing error**.
- (3) The **clearing manager** must, no later than 1700 hours on the 2nd **business day** following the **trading day** on which the written notice referred to in subclause (2) was given, provide a report to the **Authority** that includes the following:
 - (a) whether, in the **clearing manager's** view, a **pricing error** has occurred;
 - (b) the reasons for the **clearing manager's** view;
 - (c) a copy of all of the information that the **clearing manager** considered or received in relation to the pricing error which has been claimed.

Compare: Electricity Governance Rules 2003 rule 3.26G section V part G
Clause 13.173(c): amended, on 5 October 2017, by clause 421 of the Electricity Industry Participation Code Amendment (Code Review Programme) 2017.
Clause 13.173: replaced, on 1 November 2022, by clause 118 of the Electricity Industry Participation Code Amendment (Real Time Pricing) 2022.

13.173A Process when pricing error investigation commenced

- (1) If the **clearing manager** decides to investigate a potential **pricing error** under clause 13.170A by the time prescribed by that clause the **clearing manager** must, no later than 1300 hours on the 1st **business day** following the **trading day** on which the **clearing manager** made available on **WITS** the **interim price** or **interim reserve price** in respect of which the potential **pricing error** is being investigated, give a written notice on **WITS** and to the **Authority** and any person that has requested notice advising—
 - (a) that the **clearing manager** has decided to investigate a potential **pricing error**; and
 - (b) the reasons for the investigation; and
 - (c) the **trading periods** that the **clearing manager** believes may have been affected by the potential **pricing error**.
- (2) The **clearing manager** must, no later than 1700 hours on the 2nd **business day** following the **trading day** on which the written notice referred to in subclause (1) was given, provide a report to the **Authority** that includes the following:
 - (a) whether, in the **clearing manager's** view, a **pricing error** has occurred:
 - (b) the reasons for the **clearing manager's** view:
 - (d) a copy of all of the information that the **clearing manager** considered or received in relation to the potential **pricing error** which was investigated.

Clause 13.173A: inserted, on 1 November 2022, by clause 119 of the Electricity Industry Participation Code Amendment (Real Time Pricing) 2022.

Clause 13.173A(2): amended, on 1 March 2024, by clause 75 of the Electricity Industry Participation Code Amendment (Code Review Programme) 2024.

13.173B Clearing manager may request information from error claimant or participant when pricing error claim received or pricing error investigation commenced

After the written notice referred to in clause 13.173(2) or 13.173A(1) is given but prior to the **clearing manager** being required to provide a report to the **Authority** under clauses 13.173(3) or 13.173A(2) (as applicable)—

- (a) the **clearing manager** may request that an error claimant or a **participant** provide the **clearing manager** with any information that the **clearing manager** reasonably requires in order to reach a view as to whether a **pricing error** has occurred; and
- (b) each error claimant and **participant** must comply with any request made by the **clearing manager** under paragraph (a) within 1 **business day** of the request being received.

Clause 13.173B: inserted, on 1 November 2022, by clause 119 of the Electricity Industry Participation Code Amendment (Real Time Pricing) 2022.

13.173C Authority to determine whether pricing error has occurred

- (1) No later than 1700 hours on the 2nd **business day** following the **trading day** on which the **Authority** receives a report from the **clearing manager** under clause 13.173(3) or clause 13.173A(2), the **Authority** must determine whether a **pricing error** has occurred.
- (2) The **Authority** must, as soon as practicable after making its determination,—
 - (a) advise the **clearing manager** of the determination in writing; and
 - (b) give a written notice on **WITS** that includes the following information:
 - (i) the name of the error claimant (where a pricing error has been claimed):

- (ii) in relation to a claim made under clause 13.170, the reasons the error claimant has given for the claim:
- (iii) in relation to an investigation commenced by the **clearing manager** under clause 13.170A, the reasons the **clearing manager** has given for the investigation pursuant to clause 13.173A(1)(b):
- (iv) the **trading periods** specified in the written notice given on **WITS** under clause 13.173(2) or clause 13.173A(1):
- (v) the **Authority's** determination made under subclause (1):
- (vi) the **Authority's** reasons for its determination:
- (vii) in relation to a determination that a **pricing error** has occurred,—
 - (A) the **trading periods** affected by the **pricing error**; and
 - (B) the **dispatch prices** and **dispatch reserve prices** to be used to calculate the revised **interim price** or revised **interim reserve price** relating to the **pricing error**.

Clause 13.173C: inserted, on 1 November 2022, by clause 119 of the Electricity Industry Participation Code Amendment (Real Time Pricing) 2022.

13.174 *[Revoked]*

Compare: Electricity Governance Rules 2003 rule 3.26H section V part G
Clause 13.174: revoked, on 1 November 2022, by clause 120 of the Electricity Industry Participation Code Amendment (Real Time Pricing) 2022.

13.175 *[Revoked]*.

Compare: Electricity Governance Rules 2003 rule 3.26I section V part G
Clause 13.175(b): amended, on 5 October 2017, by clause 422 of the Electricity Industry Participation Code Amendment (Code Review Programme) 2017.
Clause 13.175: revoked, on 1 November 2022, by clause 121 of the Electricity Industry Participation Code Amendment (Real Time Pricing) 2022.

13.176 *[Revoked]*

Compare: Electricity Governance Rules 2003 rule 3.26J section V part G
Clause 13.176 Heading: amended, on 5 October 2017, by clause 423(1) of the Electricity Industry Participation Code Amendment (Code Review Programme) 2017.
Clause 13.176: amended, on 5 October 2017, by clause 423(2) of the Electricity Industry Participation Code Amendment (Code Review Programme) 2017.
Clause 13.176: revoked, on 1 November 2022, by clause 122 of the Electricity Industry Participation Code Amendment (Real Time Pricing) 2022.

13.177 **Clearing manager to implement Authority's determination**

Where the **Authority** advises the **clearing manager** of its determination that a **pricing error** has occurred, the **clearing manager** must, as soon as practicable after receiving the determination,—

- (a) re-calculate the **interim price** or **interim reserve price** affected by the **pricing error** using—
 - (i) the methodology described in clause 13.134A; and
 - (ii) the **dispatch prices** and **dispatch reserve prices** specified in the notice given on **WITS** under clause 13.73C(2); and
- (b) make the revised **interim price** or revised **interim reserve price** available on **WITS**.

Compare: Electricity Governance Rules 2003 rule 3.26K section V part G
Clause 13.177(1)(a), (c) and (2): amended, on 5 October 2017, by clause 424(a), (c) and (d) of the Electricity Industry Participation Code Amendment (Code Review Programme) 2017.

Clause 13.177(1)(b): replaced, on 5 October 2017, by clause 424(b) of the Electricity Industry Participation Code Amendment (Code Review Programme) 2017.

Clause 13.177: replaced, on 1 November 2022, by clause 123 of the Electricity Industry Participation Code Amendment (Real Time Pricing) 2022.

13.178 Further pricing error may be claimed or investigated in respect of revised interim prices

A person may submit a **pricing error** claim to the **clearing manager** under clause 13.170, or the **clearing manager** may decide to investigate a potential **pricing error** under clause 13.170A, in respect of a revised **interim price** or revised **interim reserve price** made available on **WITS** under clause 13.177.

Compare: Electricity Governance Rules 2003 rule 3.26L section V part G

Clause 13.178 Heading: replaced, on 5 October 2017, by clause 425(1) of the Electricity Industry Participation Code Amendment (Code Review Programme) 2017.

Clause 13.178: amended, on 5 October 2017, by clause 425(2) of the Electricity Industry Participation Code Amendment (Code Review Programme) 2017.

Clause 13.178: replaced, on 1 November 2022, by clause 124 of the Electricity Industry Participation Code Amendment (Real Time Pricing) 2022.

13.178A Pricing error claim in respect of trading periods prior to 1 November 2022

The **pricing error** claim process (including related definitions) that existed in the Code as at 31 October 2022 continues to apply to **trading periods** prior to 1 November 2022, except that the pricing manager's duties under that process are transferred to the **clearing manager**.

Clause 13.178A: inserted, on 1 November 2022, by clause 125 of the Electricity Industry Participation Code Amendment (Real Time Pricing) 2022.

13.179 [Revoked]

Compare: Electricity Governance Rules 2003 rule 3.26M section V part G

Clause 13.179: amended, on 21 September 2012, by clause 25 of the Electricity Industry Participation (Minor Amendments) Code Amendment 2012.

Clause 13.179: amended, on 5 October 2017, by clause 426 of the Electricity Industry Participation Code Amendment (Code Review Programme) 2017.

Clause 13.179: revoked, on 1 November 2022, by clause 126 of the Electricity Industry Participation Code Amendment (Real Time Pricing) 2022.

13.180 [Revoked]

Compare: Electricity Governance Rules 2003 rule 3.26N section V part G

Clause 13.180(1): amended, on 5 October 2017, by clause 427 of the Electricity Industry Participation Code Amendment (Code Review Programme) 2017.

Clause 13.180: revoked, on 1 November 2022, by clause 127 of the Electricity Industry Participation Code Amendment (Real Time Pricing) 2022.

13.181 [Revoked]

Compare: Electricity Governance Rules 2003 rule 3.26O section V part G

Clause 13.181(1): amended, on 5 October 2017, by clause 428 of the Electricity Industry Participation Code Amendment (Code Review Programme) 2017.

Clause 13.181: revoked, on 1 November 2022, by clause 128 of the Electricity Industry Participation Code Amendment (Real Time Pricing) 2022.

13.182 [Revoked]

Compare: Electricity Governance Rules 2003 rule 3.26P section V part G

Clause 13.182 Heading: amended, on 5 October 2017, by clause 429(1) of the Electricity Industry Participation Code Amendment (Code Review Programme) 2017.

Clause 13.182(2): amended, on 5 October 2017, by clause 429(2) of the Electricity Industry Participation Code Amendment (Code Review Programme) 2017.

Clause 13.182: revoked, on 1 November 2022, by clause 129 of the Electricity Industry Participation Code Amendment (Real Time Pricing) 2022.

Final Prices

Cross heading: inserted, on 1 November 2022, by clause 130 of the Electricity Industry Participation Code Amendment (Real Time Pricing) 2022.

Making final prices available

Cross heading: replaced, on 5 October 2017, by clause 430 of the Electricity Industry Participation Code Amendment (Code Review Programme) 2017.

13.182A Interim prices become final prices if no pricing error claimed or investigated

- (1) This clause applies if, by 1300 hours on the 1st **business day** following the **trading day** on which the **clearing manager** made an **interim price** or **interim reserve price** available on **WITS**, the **clearing manager** has not given a written notice under clause 13.173(2) or clause 13.173A(1) that a **pricing error** has been claimed or a potential **pricing error** is being investigated in respect of that **interim price** or **interim reserve price**.
- (2) If this clause applies, the relevant **interim price** or **interim reserve price** becomes a **final price** or **final reserve price** (as applicable) when the **clearing manager** makes the **final price** or **final reserve price** available on **WITS**, which must be after 1300 hours but no later than 1400 hours on the 1st **business day** following the **trading day** on which the **clearing manager** made the **interim price** or **interim reserve price** available on **WITS**.

Clause 13.182A: inserted, on 1 November 2022, by clause 131 of the Electricity Industry Participation Code Amendment (Real Time Pricing) 2022.

Clause 13.182A(2): amended, on 1 March 2024, by clause 76 of the Electricity Industry Participation Code Amendment (Code Review Programme) 2024.

13.182B Interim prices become final prices if no pricing error exists

- (1) This clause applies if the **clearing manager** has given a written notice under clause 13.173(2) or clause 13.173A(1) that a **pricing error** has been claimed or a potential **pricing error** is being investigated.
- (2) If this clause applies, the relevant **interim price** or **interim reserve price** becomes a **final price** or **final reserve price** (as applicable) when the **clearing manager** makes the **final price** or **final reserve price** available on **WITS**, which must be as soon as practicable after the **Authority** has made available on **WITS** a notice under clause 13.173C(2) advising that no **pricing error** has occurred.

Clause 13.182B: inserted, on 1 November 2022, by clause 131 of the Electricity Industry Participation Code Amendment (Real Time Pricing) 2022.

Clause 13.182B(2): amended, on 1 March 2024, by clause 77 of the Electricity Industry Participation Code Amendment (Code Review Programme) 2024.

13.183 Final prices not to change

Unless the **Authority** directs otherwise under clause 5.2, **final prices** and **final reserve prices** cannot be changed, despite the fact that a **final price** or **final reserve price** may contain an error.

Compare: Electricity Governance Rules 2003 rule 3.27 section V part G

Clause 13.183 Heading: replaced, on 5 October 2017, by clause 431(1) of the Electricity Industry Participation Code Amendment (Code Review Programme) 2017. Clause 13.183: amended, on 5 October 2017, by clause 431(2) of the Electricity Industry Participation Code Amendment (Code Review Programme) 2017.

Clause 13.183: replaced, on 1 November 2022, by clause 132 of the Electricity Industry Participation Code Amendment (Real Time Pricing) 2022.

13.184 Authority may order delay of interim prices becoming final prices

- (1) Despite clauses 13.134A to 13.191, the **Authority** may make available on **WITS** a notice preventing an **interim price** or **interim reserve price** from becoming a **final price** or **final reserve price** (as applicable) until such time as the **Authority** specifies in the notice.
- (2) If the **Authority** makes a notice available on **WITS** under subclause (1), the **clearing manager** must not make available on **WITS** the relevant **final price** or **final reserve price** until the time specified in the notice.

Compare: Electricity Governance Rules 2003 rule 3.28 section V part G

Clause 13.184: replaced, on 5 October 2017, by clause 432 of the Electricity Industry Participation Code Amendment (Code Review Programme) 2017.

Clause 13.184: replaced, on 1 November 2022, by clause 133 of the Electricity Industry Participation Code Amendment (Real Time Pricing) 2022.

13.185 *[Revoked]*

Compare: Electricity Governance Rules 2003 rule 3.29 section V part G

Clause 13.185: substituted, on 21 September 2012, by clause 26 of the Electricity Industry Participation (Minor Amendments) Code Amendment 2012.

Clause 13.185: amended, on 5 October 2017, by clause 433 of the Electricity Industry Participation Code Amendment (Code Review Programme) 2017.

Clause 13.185: revoked, on 1 November 2022, by clause 134 of the Electricity Industry Participation Code Amendment (Real Time Pricing) 2022.

Miscellaneous requirements relating to calculation of prices

13.186 *[Revoked]*.

Compare: Electricity Governance Rules 2003 rule 3.30 section V part G

Clause 13.186: revoked, on 1 November 2022, by clause 135 of the Electricity Industry Participation Code Amendment (Real Time Pricing) 2022.

13.187 *[Revoked]* Compare: Electricity Governance Rules 2003 rule 3.31 section V part G

Clause 13.186: revoked, on 1 November 2022, by clause 136 of the Electricity Industry Participation Code Amendment (Real Time Pricing) 2022.

13.188 *[Revoked]*

Compare: Electricity Governance Rules 2003 rule 3.32 section V part G

Clause 13.188 Heading: amended, on 5 October 2017, by clause 434(1) of the Electricity Industry Participation Code Amendment (Code Review Programme) 2017.

Clause 13.188(1) and (3): amended, on 5 October 2017, by clause 434(2) and (3) of the Electricity Industry Participation Code Amendment (Code Review Programme) 2017.

Clause 13.188: revoked, on 1 November 2022, by clause 137 of the Electricity Industry Participation Code Amendment (Real Time Pricing) 2022.

13.189 System operator to give Authority list of model variable values

- (1) If the value of the model parameters listed in Schedule 13.2 are to be changed, the **system operator** must immediately give the **Authority** an updated list of values in writing.
- (2) The **Authority** must acknowledge receipt of the updated list in writing.
- (3) Changes specified in any updated list must become effective from a date specified by the **system operator**, subject to agreement in writing from the **Authority**.

Compare: Electricity Governance Rules 2003 rule 3.33 section V part G

Clause 13.189 Heading: amended, on 3 November 2016, by clause 5(1) of the Electricity Industry Participation Code Amendment (Dispatchable Demand During Tight Market Conditions) 2016.

Clause 13.189(1): revoked, on 3 November 2016, by clause 5(2) of the Electricity Industry Participation Code Amendment (Dispatchable Demand During Tight Market Conditions) 2016.

Clause 13.189(2): amended, on 3 November 2016, by clauses 5(3) and 5(4) of the Electricity Industry Participation Code Amendment (Dispatchable Demand During Tight Market Conditions) 2016.

Clause 13.189(2A): inserted, on 3 November 2016, by clause 5(5) of the Electricity Industry Participation Code Amendment (Dispatchable Demand During Tight Market Conditions) 2016.

Clause 13.189(3): amended, on 3 November 2016, by clause 5(6) of the Electricity Industry Participation Code Amendment (Dispatchable Demand During Tight Market Conditions) 2016.

Clause 13.189(4): amended, on 3 November 2016, by clause 5(7)(a) and (b) of the Electricity Industry Participation Code Amendment (Dispatchable Demand During Tight Market Conditions) 2016.

Clause 13.189: replaced, on 1 November 2022, by clause 138 of the Electricity Industry Participation Code Amendment (Real Time Pricing) 2022.

13.189A *[Revoked]*

Clause 13.189A: inserted, on 15 May 2014, by clause 56 of the Electricity Industry Participation (Modified Dispatchable Demand) Code Amendment 2013.

Clause 13.189A: revoked, on 1 November 2022, by clause 139 of the Electricity Industry Participation Code Amendment (Real Time Pricing) 2022.

13.190 All information and notices to be unconditional and final

(1) *[Revoked]*

(2) Except as provided for in this Code, **participants** may treat all information and notices given under clauses 13.135 to 13.191 as **final**.

Compare: Electricity Governance Rules 2003 rule 3.34 section V part G

Clause 13.190 Heading: replaced, on 5 October 2017, by clause 435(1) of the Electricity Industry Participation Code Amendment (Code Review Programme) 2017.

Clause 13.190(1): revoked, on 5 October 2017, by clause 435(2)(a) of the Electricity Industry Participation Code Amendment (Code Review Programme) 2017.

Clause 13.190(2): amended, on 5 October 2017, by clause 435(2)(b) of the Electricity Industry Participation Code Amendment (Code Review Programme) 2017.

13.191 Backup procedures if WITS or approved system is unavailable

(1) If **WITS** or the **approved system** is unavailable for the purposes of giving information or making information available under clauses 13.134A to 13.191, each **grid owner** and the **WITS manager** must follow the backup procedures specified by the **WITS manager**.

(2) The backup procedures referred to in subclause (1) must be specified by the **WITS manager** following consultation with the **Authority, generators, purchasers, ancillary service agents, the grid owners and the clearing manager**.

Compare: Electricity Governance Rules 2003 rules 3.35 and 3.36 section V part G

Clause 13.191 Heading: amended, on 5 October 2017, by clause 436(1) of the Electricity Industry Participation Code Amendment (Code Review Programme) 2017.

Clause 13.191(1): replaced, on 5 October 2017, by clause 436(2)(a) of the Electricity Industry Participation Code Amendment (Code Review Programme) 2017.

Clause 13.191(2): amended, on 5 October 2017, by clause 436(2)(b) of the Electricity Industry Participation Code Amendment (Code Review Programme) 2017.

Clause 13.191(3): revoked, on 5 October 2017, by clause 436(2)(c) of the Electricity Industry Participation Code Amendment (Code Review Programme) 2017.

Clause 13.191: replaced, on 1 November 2022, by clause 140 of the Electricity Industry Participation Code Amendment (Real Time Pricing) 2022.

Calculation of constrained off amounts

13.192 Constrained off situations may occur

(1) A **constrained off situation** occurs when—

- (a) a **generator** (other than a **dispatch notification generator**) is not given a **dispatch instruction**, or is not dispatched by the **system operator** to the level expected based on the **generator's offer** compared to the relevant **final price**, for a **trading period** despite the **generator** having offered **electricity** at a price below the **final price** for that **trading period** at the relevant **grid injection point**; or

- (b) in relation to a **block dispatch group** or **station dispatch group**, a **generator** (other than a **dispatch notification generator**) is not given a **dispatch instruction**, or is not dispatched by the **system operator** to the level expected based on the **generator's offer** compared to the **final price**, for the **trading period**, despite the **generator** having offered **electricity** in the **trading period** at a **grid injection point** within the **block dispatch group** or **station dispatch group** below the **final price** at the relevant **grid injection point** in that **trading period**, and the aggregate quantity of those **offers** is greater than the dispatched quantity calculated in accordance with clause 13.194; or
 - (c) load to which a **nominated dispatch bid** (other than a **dispatch notification purchaser bid**) applies is not **dispatched**, and where the price in the **nominated dispatch bid** is above the **final price** at the relevant **GXP**.
- (2) In this clause,—
- (a) an **offer** made by a **generator** means the last **offer** made by the **generator** which applied during the relevant **trading period**; and
 - (b) a **bid** made by a **purchaser** means the last **bid** made by the **purchaser** which applied during the relevant **trading period**.

Compare: Electricity Governance Rules 2003 rule 4.1 section V part G

Clause 13.192(c): inserted, on 15 May 2014, by clause 57 of the Electricity Industry Participation (Modified Dispatchable Demand) Code Amendment 2013.

Clause 13.192(c): amended, on 1 December 2015, by clause 7 of the Electricity Industry Participation Code Amendment (Dispatchable Demand: Late Bid Revisions) 2015.

Clause 13.192: replaced, on 1 November 2022, by clause 141 of the Electricity Industry Participation Code Amendment (Real Time Pricing) 2022.

Clause 13.192(1)(c): amended, on 1 March 2024, by clause 78 of the Electricity Industry Participation Code Amendment (Code Review Programme) 2024.

13.192A No constrained off situation for intermittent generating stations

Despite clause 13.192, no **constrained off situation** arises in relation to an **intermittent generating station**.

Clause 13.192A: inserted, at 12.00 pm on 19 September 2019, by clause 28 of the Electricity Industry Participation Code Amendment (Wind Offer Arrangements) 2019.

13.193 Determining affected price bands for block dispatch groups and station dispatch groups

- (1) If a **constrained off situation** occurs for a **block dispatch group** or **station dispatch group** during any **trading period** during a **billing period**, the **clearing manager** must determine the affected price bands for that **block dispatch group** or **station dispatch group** by—
- (a) taking all the **offers** made by that **block dispatch group** or **station dispatch group** in relation to that **trading period**, calculating the differences between each **offer price** and **final price** for each **grid injection point**, and ranking the differences in ascending order; and
 - (b) identifying each price band ranked under paragraph (a) in which the aggregate quantity in all previous price bands plus the quantity for that price band is greater than 0 or the **dispatched** quantity calculated in accordance with clause 13.194, but is less than the aggregate quantity for all the **generating plant** in that **block dispatch group** or **station dispatch group** calculated by the **clearing manager** using the methodology set out in Schedule 13.3. The **offer prices** corresponding to the ranked price bands identified under this paragraph are the affected price

bands for the **block dispatch group** or **station dispatch group** for the purposes of clauses 13.194 to 13.196.

- (2) In this clause, an **offer** made by a **generator** means the last **offer** made by the **generator** which applied during the relevant **trading period**.

Compare: Electricity Governance Rules 2003 rule 4.2 section V part G

Clause 13.193(b): amended, on 1 November 2022, by clause 142(1) of the Electricity Industry Participation Code Amendment (Real Time Pricing) 2022.

Clause 13.193(2): inserted, on 1 November 2022, by clause 142(2) of the Electricity Industry Participation Code Amendment (Real Time Pricing) 2022.

13.194 Clearing manager to calculate constrained off amounts

- (1) Despite clause 13.193, if a **constrained off situation** occurs, in relation to a **generator**, during a **trading period**, the **clearing manager** must calculate the **constrained off amounts** for each **generator**, for each affected price band, using the following formula:

$$\text{COF}_g = Q_{\text{cof}} * (P_f - P_o)$$

where

COF_g is the **constrained off amount** for a **generator**

Q_{cof} is the **dispatched** quantity in **MWh** (calculated under subclause (3)) from that price band in the **offer** that was constrained off during a **trading period**, or the positive difference between the **reconciliation information** and the **scheduled quantity**, whichever is less

P_o is the price **offered** for that price band by that **generator** for the quantity of **electricity** from the **generating plant** that was constrained off

P_f is the **final price** for that **trading period** at the **grid injection point**.

- (2) If a **constrained off situation** occurs in relation to a **dispatch-capable load station** during a **trading period**, the **clearing manager** must calculate the **constrained off amounts** for each **dispatch-capable load station**, for each affected **nominated dispatch bid** price band, using the following formula:

$$\text{ConOffAmt}_{\text{disp}} = \text{ConOffQ} * (P_b - P_f)$$

where

$\text{ConOffAmt}_{\text{disp}}$ is the **constrained off amount** for a **dispatch-capable load station** for the **nominated dispatch bid** price band

ConOffQ is the amount in **MWh** by which Q_b exceeds the highest of Q_{disp} and Q_{rec}

where

Q_b is the quantity, in **MWh**, in the **nominated dispatch bid** band where the bid price is above the final price

- Q_{disp} is the **dispatched** quantity, in **MWh** in the **trading period**, calculated under subclause (3), **dispatched** for the **nominated dispatch bid** price band in the **trading period**
- Q_{rec} is the **reconciled quantity** provided by the **reconciliation manager** under clause 15.20C allocated by the **clearing manager** to the **nominated dispatch bid** price band in the **trading period**
- P_b is the price bid for the **nominated dispatch bid** price band for the **dispatch-capable load station** that was constrained off
- P_f is the **final price** for the **trading period** at the **grid exit point**.

- (3) For the purposes of clauses 13.192 to 13.201, **dispatched** quantity must be calculated taking into account—
- (a) the quantity in **MW** recorded in the log kept by the **system operator** in accordance with clause 13.76 and, if required, the **clearing manager** must aggregate such quantities for—
 - (i) **generating stations** or **generating units** in the relevant **station dispatch group**; or
 - (ii) **generating units**, if the **clearing manager** requires the **dispatched** quantity to be determined on a **grid injection point** basis; and
 - (b) for an **offer**, the ramp rate applying to that **constrained off situation** that is specified in the **offer** submitted by that **generator**, or—
 - (i) for a **block dispatch group** or a **station dispatch group**; or
 - (ii) for **generating units**, if the **clearing manager** requires the **dispatched** quantity to be determined on a **grid injection point** basis—
the fastest of the ramp rates applying to that **constrained off situation** that are specified in the **offers** submitted by the **generator** in that **block dispatch group**, that **station dispatch group** or those **generating units electrically connected** to the relevant **grid injection point** (as the case may be); and
 - (c) plus or minus the **MW** bandwidth applicable for each **generator** affected by a **frequency keeping** requirement as advised by the **system operator** to the **clearing manager**, and, if required, the **clearing manager** must aggregate the **MW** bandwidth applicable to determine the **MW** bandwidth on a **grid injection point** basis.
- (4) In this clause,—
- (a) an **offer** made by a **generator** means the last **offer** made by the **generator** which applied during the relevant **trading period**; and
 - (b) a **bid** made by a **purchaser** means the last **bid** made by the **purchaser** which applied during the relevant **trading period**.

Compare: Electricity Governance Rules 2003 rule 4.3.1 section V part G

Clause 13.194(1): amended, on 15 May 2014, by clause 58(1) of the Electricity Industry Participation (Modified Dispatchable Demand) Code Amendment 2013.

Clause 13.194(1A): inserted, on 15 May 2014, by clause 58(2) of the Electricity Industry Participation (Modified Dispatchable Demand) Code Amendment 2013.

Clause 13.194(2)(b): amended, on 5 October 2017, by clause 437 of the Electricity Industry Participation Code Amendment (Code Review Programme) 2017.

Clause 13.194(2)(b): amended, on 1 November 2018, by clause 90 of the Electricity Industry Participation Code Amendment (Code Review Programme) 2018.

Clause 13.194(2)(b) & (c): amended, on 15 May 2014, by clause 58(3) & (4) of the Electricity Industry Participation (Modified Dispatchable Demand) Code Amendment 2013.

Clause 13.194(2)(b)(ii): amended, on 21 September 2012, by clause 27 of the Electricity Industry Participation (Minor Amendments) Code Amendment 2012.

Clause 13.194(2)(b): amended, on 23 February 2015, by clause 75 of the Electricity Industry Participation Code Amendment (Distributed Generation) 2014.

Clause 13.194(2)(c): amended, on 15 May 2014, by clause 49 of the Electricity Industry Participation (Minor Code Amendments) Code Amendment 2014.

Clause 13.194: replaced, on 1 November 2022, by clause 143 of the Electricity Industry Participation Code Amendment (Real Time Pricing) 2022.

Clause 13.194(2): amended, on 1 March 2024, by clause 79 of the Electricity Industry Participation Code Amendment (Code Review Programme) 2024.

13.195 Constrained off amount for block dispatch groups and station dispatch groups

The **constrained off amounts** for a **block dispatch group** or **station dispatch group** must equal the sum of the amounts calculated in accordance with clause 13.194 for the **generating plant in block dispatch group** or **station dispatch group**.

Compare: Electricity Governance Rules 2003 rule 4.3.2 section V part G

13.196 Calculation of constrained off amounts attributable to system operator

If a **constrained off situation** occurs during any **trading period** in the previous **billing period**, and the **clearing manager** receives notice of the **constrained off situation** under clause 13.76, the **clearing manager** must determine the portion of the **constrained off amounts** calculated under clause 13.194 that is attributable to the **system operator** for each **generator** as follows:

- (a) if the **system operator** has advised the **clearing manager** that a **voltage support** or other **constrained off situation** occurred (including, but not limited to, **over frequency reserve** and **instantaneous reserve**) the **system operator** must be allocated the total **constrained off amount**:
- (b) if the **system operator** has advised the **clearing manager** that a non-security **constrained off situation** occurred, the **system operator** must be allocated a **constrained off amount** calculated in accordance with the following formula:

$$\text{SOCOFNS}_{\text{so}} = \text{TCOFFP} * (\text{SOQcoffns} / \text{TQcoff})$$

where

$\text{SOCOFNS}_{\text{so}}$ is the **constrained off amount** attributable to the **system operator** for that non-security **constrained off situation**

TCOFFP is the total constrained off payment for that **trading period**

SOQcoffns is the non-security quantity that was constrained off and advised to the **clearing manager** by the **system operator** under clause 13.76 or the total quantity constrained off, whichever is less

TQcoff is the total quantity constrained off:

- (c) if the **system operator** has advised the **clearing manager** that a **frequency keeping** situation occurred in a **trading period** the **system operator** must be allocated a **constrained off amount** calculated in accordance with the following formula:

$$\text{SOCOFFK}_{\text{so}} = \text{TCOFP} * (\text{SOQcofffk} / \text{TQcoff})$$

where

$\text{SOCOFFK}_{\text{so}}$ is the **constrained off amount** attributable to the **system operator** for that **frequency keeping constrained off situation**

TCOFP is the total constrained off payment for the **generator** for the **trading period**

SOQcofffk is the **frequency keeping** quantity advised to the **clearing manager** by the **system operator** under clause 13.76 or the total quantity constrained off for the **generator**, whichever is less

TQcoff is the total quantity constrained off for the **generator**.

Compare: Electricity Governance Rules 2003 rule 4.3.3 section V part G

Clause 13.196 Heading: amended, on 5 October 2017, by clause 438(1) of the Electricity Industry Participation Code Amendment (Code Review Programme) 2017.

Clause 13.196: amended, on 5 October 2017, by clause 438(2) of the Electricity Industry Participation Code Amendment (Code Review Programme) 2017.

Clause 13.196(c): amended, on 15 May 2014, by clause 59 of the Electricity Industry Participation (Modified Dispatchable Demand) Code Amendment 2013.

Clause 13.196(c): amended, on 20 December 2021, by clause 59 of the Electricity Industry Participation Code Amendment (Code Review Programme) 2019.

Clause 13.196: amended, on 1 November 2022, by clause 144 of the Electricity Industry Participation Code Amendment (Real Time Pricing) 2022.

13.197 Timeframe for calculating constrained off amounts

Each **billing period**, the **clearing manager** must calculate **constrained off amounts** for the previous **billing period** in accordance with clauses 13.194 to 13.196 by the later of—

- (a) 1600 hours on the 8th **business day** of the **billing period** after the previous **billing period**; and
- (b) 1600 hours on the 1st **business day** after the **clearing manager** receives the information required to calculate **constrained off amounts**.

Compare: Electricity Governance Rules 2003 rule 4.4 section V part G

Clause 13.197: amended, on 21 September 2012, by clause 28 of the Electricity Industry Participation (Minor Amendments) Code Amendment 2012.

Clause 13.197: replaced, on 1 November 2018, by clause 91 of the Electricity Industry Participation Code Amendment (Code Review Programme) 2018.

13.198 Clearing manager to send constrained off information to system operator

- (1) The **clearing manager** must, at the time specified in clause 13.197, send to the **system operator** the details of **constrained off amounts** that are attributable to the **system operator** (but limited to information about those **constrained off amounts** that is in the

possession of the **clearing manager**) and the constrained off quantities (in **MW**) calculated in accordance with clause 13.196 for the previous **billing period**.

- (2) The information must be provided to the **system operator** in the manner and format agreed between the **clearing manager** and the **system operator** from time to time.

Compare: Electricity Governance Rules 2003 rule 4.5 section V part G

Clause 13.198(1): amended, on 15 May 2014, by clause 60 of the Electricity Industry Participation (Modified Dispatchable Demand) Code Amendment 2013.

13.199 Clearing manager to make details of constrained off amounts available

The **clearing manager** must, at the time specified in clause 13.197, **publish** the details of **constrained off amounts** for each **generator** and each **dispatched purchaser** for the previous **billing period** as follows:

- (a) the **constrained off amounts** calculated in accordance with clauses 13.194 to 13.196:
- (b) the **generator** or **dispatched purchaser** (as the case may be) that was constrained off:
- (c) the applicable **grid injection point**, or **grid exit point**, or **block dispatch group**, or **station dispatch group**.

Compare: Electricity Governance Rules 2003 rule 4.6 section V part G

Clause 13.199 Heading: amended, on 5 October 2017, by clause 439(1) of the Electricity Industry Participation Code Amendment (Code Review Programme) 2017.

Clause 13.199: amended, on 15 May 2014, by clause 61 of the Electricity Industry Participation (Modified Dispatchable Demand) Code Amendment 2013.

Clause 13.199: amended, on 5 October 2017, by clause 439(2) of the Electricity Industry Participation Code Amendment (Code Review Programme) 2017.

Clause 13.199: amended, on 1 March 2024, by clause 80 of the Electricity Industry Participation Code Amendment (Code Review Programme) 2024.

13.200 Authority, generators and purchasers have rights to constrained off information

- (1) In addition to the information the **clearing manager** makes available under clause 13.199, a **generator** or **purchaser** who reasonably believes it was adversely affected by a **constrained off situation** occurring, or the **Authority**, may request information from the **system operator** about the cause of the **constrained off situation**.
- (2) The **system operator** must comply with any reasonable request made for such information provided that the information does not include any information that is confidential in respect of any other **generator** or **purchaser**.

Compare: Electricity Governance Rules 2003 rule 4.7 section V part G

Clause 13.200(1): amended, on 5 October 2017, by clause 440 of the Electricity Industry Participation Code Amendment (Code Review Programme) 2017.

13.201 Generators do not get paid constrained off compensation

- (1) A **generator** is not entitled to be paid compensation in respect of any **constrained off situation** except as provided for in an **ancillary service arrangement** entered into by the **system operator** and the **generator**.
- (2) This clause does not affect the rights that a **participant** has under this Code against the **system operator** for a failure by the **system operator** to comply with this Code.

Compare: Electricity Governance Rules 2003 rule 4.8 section V part G

13.201A Dispatched purchasers entitled to constrained off compensation and purchasers to pay constrained off compensation

- (1) A **dispatched purchaser** in respect of whose **dispatch-capable load station** there was a **constrained off situation** as described in clause 13.192(1)(c) is owed **constrained off compensation** for the **constrained off amounts** calculated under clause 13.194(2).

-
- (2) A **purchaser** that purchases **electricity** at a **grid exit point** incurs an amount owing to the **clearing manager** for **constrained off compensation**, calculated under subclause (6).
- (2A) The **clearing manager** must advise each **purchaser** of the amount owing by the **purchaser** for **constrained off compensation** for a **billing period** when the **clearing manager** advises amounts owing under subpart 4 of Part 14.
- (3) The **clearing manager** owes **constrained off compensation** received under subclause (2), for each **dispatch-capable load station**, to the **dispatched purchaser** that purchased **electricity** for the **dispatch-capable load station**.
- (4) The **clearing manager** must advise each **dispatched purchaser** of the amount owing to the **dispatched purchaser** for **constrained off compensation** for a **billing period** when the **clearing manager** advises amounts owing under subpart 4 of Part 14.
- (5) *[Revoked]*
- (6) The **clearing manager** must calculate **constrained off compensation** owing by a **purchaser** under subclause (2) for each **trading period** using the following formula:

$$\text{ConOffC}_p = \text{ConOffC}_{\text{DLPs}} * (\text{Pur}_i / \text{TotPur})$$

where

- ConOffC_p is the **constrained off compensation** owing by a **purchaser**
- $\text{ConOffC}_{\text{DLPs}}$ is the sum of **constrained off compensation** owing to all **dispatched purchasers** for the **trading period**
- Pur_i is the total quantity in **MWh** of all purchases by the **purchaser** from the **clearing manager** during the **trading period**, as shown by **reconciliation information** calculated by the **reconciliation manager** under Part 15
- TotPur is the quantity in **MWh** of all purchases by all **purchasers** from the **clearing manager** during the **trading period**, as shown by **reconciliation information** calculated by the **reconciliation manager** under Part 15.

Clause 13.201A: inserted, on 15 May 2014, by clause 62 of the Electricity Industry Participation (Modified Dispatchable Demand) Code Amendment 2013.

Clause 13.201A(1): amended, on 24 March 2015, by clause 12(a) of the Electricity Industry Participation (Settlement and Prudential Security) Code Amendment 2013.

Clause 13.201A(2): amended, on 24 March 2015, by clause 12(b) of the Electricity Industry Participation (Settlement and Prudential Security) Code Amendment 2013.

Clause 13.201A(2A): inserted, on 24 March 2015, by clause 12(c) of the Electricity Industry Participation (Settlement and Prudential Security) Code Amendment 2013.

Clause 13.201A(3): substituted, on 24 March 2015, by clause 12(d) of the Electricity Industry Participation (Settlement and Prudential Security) Code Amendment 2013.

Clause 13.201A(4): substituted, on 24 March 2015, by clause 12(e) of the Electricity Industry Participation (Settlement and Prudential Security) Code Amendment 2013.

Clause 13.201A(5): revoked, on 24 March 2015, by clause 12(f) of the Electricity Industry Participation (Settlement and Prudential Security) Code Amendment 2013.

Clause 13.201A(6): amended, on 24 March 2015, by clause 12(g) of the Electricity Industry Participation (Settlement and Prudential Security) Code Amendment 2013.

Clause 13.201A: amended, on 1 November 2022, by clause 145 of the Electricity Industry Participation Code Amendment (Real Time Pricing) 2022.

Calculation of constrained on amounts

13.202 Constrained on situations may occur

- (1) A **constrained on situation** occurs when—
 - (a) a **generator** is given a **dispatch instruction** by the **system operator** and the price **offered** by the **generator** for that **dispatched** quantity of **electricity** at the relevant **grid injection point** and **trading period** is higher than the **final price** at that **grid injection point** in the relevant **trading period**; or
 - (b) in relation to a **block dispatch group** or **station dispatch group**, a **generator** is given a **dispatch instruction** by the **system operator** and the price **offered** by the **generator** for that aggregate **dispatched** quantity of **electricity** from that **block dispatch group** or **station dispatch group** in the relevant **trading period** is higher than the **final price** in the relevant **trading period**; or
 - (c) an **ancillary service agent** is given a **dispatch instruction** by the **system operator** and the price **offered** by the **ancillary service agent** for the **dispatched instantaneous reserve** in the relevant **trading period** is higher than the **final reserve price** of the **dispatched instantaneous reserve** in the relevant **trading period**; or
 - (d) load to which a **nominated dispatch bid** (other than a **dispatch notification purchaser bid**) applies is **dispatched**, and the price in the **nominated dispatch bid** is below the **final price** at the relevant **GXP**.
- (2) In this clause,—
 - (a) an **offer** made by a **generator** means the last **offer** made by the **generator** which applied during the relevant **trading period**; and
 - (b) a **bid** made by a **purchaser** means the last **bid** made by the **purchaser** which applied during the relevant **trading period**.

Compare: Electricity Governance Rules 2003 rule 5.1 section V part G

Clause 13.202(1): amended, on 1 June 2013, by clause 16(a) of the Electricity Industry Participation (Scarcity Pricing) Code Amendment 2011.

Clause 13.202(1)(c): amended, on 1 November 2018, by clause 92 of the Electricity Industry Participation Code Amendment (Code Review Programme) 2018.

Clause 13.202(1)(d): inserted, on 15 May 2014, by clause 63 of the Electricity Industry Participation (Modified Dispatchable Demand) Code Amendment 2013.

Clause 13.202(1)(d): amended, on 1 December 2015, by clause 8 of the Electricity Industry Participation Code Amendment (Dispatchable Demand: Late Bid Revisions) 2015.

Clause 13.202(2): inserted, on 1 June 2013, by clause 16(b) of the Electricity Industry Participation (Scarcity Pricing) Code Amendment 2011.

Clause 13.202: replaced, on 1 November 2022, by clause 146 of the Electricity Industry Participation Code Amendment (Real Time Pricing) 2022.

Clause 13.202(1)(d): amended, on 1 March 2024, by clause 81 of the Electricity Industry Participation Code Amendment (Code Review Programme) 2024.

13.203 Determining affected price bands for block dispatch groups or station dispatch groups

- (1) If a **constrained on situation** occurred for a **block dispatch group** or **station dispatch group** during any **trading period** during the previous **billing period**, the **clearing manager** must determine the affected price bands for that **block dispatch group** or **station dispatch group** by—
 - (a) taking all the **offers** made by that **block dispatch group** or **station dispatch group** in relation to that **trading period**, calculating the differences between each **offer price** and **final price** for each **grid injection point** and ranking the differences in ascending order; and

- (b) identifying each price band ranked under paragraph (a) in which the aggregate quantity for that price band plus all the quantity in all previous price bands exceeds the aggregate quantity for all the **generating plant** in that **block dispatch group** or **station dispatch group** calculated by the **clearing manager** using the methodology set out in Schedule 13.3. The **offer** prices corresponding to the ranked price bands identified under this paragraph are the affected price bands for that **block dispatch group** or **station dispatch group** for the purposes of clause 13.204.
- (2) In this clause, an **offer** made by a **generator** means the last **offer** made by the **generator** which applied during the relevant **trading period**
Compare: Electricity Governance Rules 2003 rule 5.2 section V part G
Clause 13.203(b): amended, on 1 November 2022, by clause 147(1) of the Electricity Industry Participation Code Amendment (Real Time Pricing) 2022.
Clause 13.203(2): inserted, on 1 November 2022, by clause 147(2) of the Electricity Industry Participation Code Amendment (Real Time Pricing) 2022.

13.204 Calculation of constrained on amounts

- (1) If a **constrained on situation** occurs during any **trading period** during a previous **billing period**,—
- (a) the **clearing manager** must calculate the **constrained on amounts** for a **constrained on situation** described in clause 13.202(1)(a) or (b) for each **generator** for each affected price band in accordance with the following formula:

$$\text{COC} = Q_{\text{con}} * (P_o - P_f)$$

where

COC is the **constrained on amount** for a **generator**

Q_{con} is the **dispatched** quantity in **MWh** (calculated under paragraph (b)) from that price band in the **offer** that was constrained on during a **trading period**, or the positive difference between the **reconciliation information** and the **scheduled quantity**, whichever is less

P_o is the price offered for that price band by the **generator** for the quantity of **electricity** from the **generating plant** which was constrained on

P_f is the **final price** for that **trading period** at the **grid injection point**; and

- (aa) the **clearing manager** must calculate the **constrained on amounts** for a **constrained on situation** described in clause 13.202(1)(d) for each **dispatch-capable load station** for each affected **nominated dispatch bid** price band, using the following formula:

$$\text{ConOnAmt} = \text{ConOnQ} * (P_f - P_b)$$

where

ConOnAmt is the **constrained on amount** for a **dispatch-capable load station** for the **nominated dispatch bid** price band

ConOnQ is the amount in **MWh** by which the lowest of Q_{disp} and Q_{rec} exceeds Q_b

where

Q_b is the quantity, in **MWh**, in the **nominated dispatch bid** price band where the bid price is below the final price.

Q_{disp} is the **dispatched** quantity in **MWh** in the **trading period**, calculated under paragraph (b), for the **nominated dispatch bid** price band in the **trading period**

Q_{rec} is the **reconciled quantity** provided by the **reconciliation manager** under clause 15.20C allocated by the **clearing manager** to the **nominated dispatch bid** price band in the **trading period**

P_f is the **final price** for the **trading period** at the **grid exit point**

P_b is the price bid for the **nominated dispatch bid** price band for the **dispatch-capable load station** that was constrained on; and

- (b) for the purposes of clauses 13.202 to 13.211 **dispatched** quantity must be calculated taking into account—
- (i) the quantity in **MW** recorded in the log kept by the **system operator** in accordance with clause 13.76; and if required, the **clearing manager** must aggregate such quantities for—
 - (A) **generating stations** or **generating units** in the relevant **station dispatch group**; or
 - (B) **generating units**, if the **clearing manager** requires a **dispatched** quantity to be determined on a **grid injection point** basis; and
 - (ii) for an **offer**, the ramp rate applying to that **constrained on situation** that is specified in the **offer** submitted by the **generator**, or—
 - (A) for a **block dispatch group** or a **station dispatch group**; or
 - (B) for **generating units**, if the **clearing manager** requires the **dispatched** quantity to be determined on a **grid injection point** basis—

the fastest of the ramp rates applying to that **constrained on situation** that are specified in the **offers** submitted by the **generator** in that **block dispatch group**, that **station dispatch group** or those **generating units electrically connected** to the relevant **grid injection point** (as the case may be); and
 - (iii) plus or minus the **MW** bandwidth applicable for each **generator** affected by a **frequency keeping** requirement as advised by the **system operator** to the **clearing manager** under clause 13.76 and, if required, the **clearing manager** must aggregate the **MW** bandwidth applicable to determine the **MW** bandwidth on a **grid injection point** basis; and

- (c) the **clearing manager** must calculate the **constrained on amounts** for a **constrained on situation** described in clause 13.202(1)(c) for each **ancillary service agent** for each affected price band in accordance with the following formula:

$$\text{COC} = Q_{\text{con}} * (P_o - P_f)$$

where

COC is the **constrained on amount** for an **ancillary service agent**

Q_{con} is the **dispatched** quantity of **instantaneous reserve** in **MW** (calculated under paragraph (d)) from that price band in the **reserve offer** that was constrained on during a **trading period**

P_o is the price offered for that price band by that **ancillary service agent** for the quantity **Q_{con}**

P_f is the **final reserve price** for that **trading period** at the **point of connection** on the **grid**; and

- (d) for the purposes of paragraph (c), in determining the **dispatched** quantity, the **clearing manager** must take into account the quantity in **MW** of **instantaneous reserve dispatched** for the **ancillary service agent** recorded in the log kept by the **system operator** in accordance with clause 13.76; and
- (e) the **constrained on amounts** for a **block dispatch group** or **station dispatch group** equal the sum of the amounts calculated in accordance with paragraphs (a) and (b) for the **generating plant** in that **block dispatch group** or **station dispatch group** (as the case may be); and
- (f) in relation to any 2 adjacent **trading periods**, a **generator** is entitled to be paid for the 2nd **trading period** at the **final price** for the **grid injection point** if the **generator**—
- (i) was in a **constrained on situation** in the 1st **trading period**; and
 - (ii) continues to generate in the 2nd **trading period** as a result of a **dispatch instruction** given for the 1st **trading period**; but
 - (iii) has not made an **offer** in the 2nd **trading period**.
- (2) To avoid doubt, nothing in this clause entitles the **system operator** to issue any instruction to a **generator** in relation to **unoffered generation**.
- (3) In this clause,—
- (a) an **offer** made by a **generator** means the last **offer** made by the **generator** which applied during the relevant **trading period**; and
 - (b) a **bid** made by a **purchaser** means the last **bid** made by the **purchaser** which applied during the relevant **trading period**.

Compare: Electricity Governance Rules 2003 rule 5.3 section V part G

Clause 13.204(1)(a): amended, on 5 October 2017, by clause 441 of the Electricity Industry Participation Code Amendment (Code Review Programme) 2017.

Clause 13.204(1)(a): amended, on 1 November 2022, by clause 148(1) of the Electricity Industry Participation Code Amendment (Real Time Pricing) 2022.

Clause 13.204(1)(aa): inserted, on 15 May 2014, by clause 64(a) of the Electricity Industry Participation (Modified Dispatchable Demand) Code Amendment 2013.

Clause 13.204(1)(aa): amended, on 1 November 2022, by clause 148(2) of the Electricity Industry Participation Code Amendment (Real Time Pricing) 2022.
Clause 13.204(1)(b): amended, on 1 November 2022, by clause 148(3) of the Electricity Industry Participation Code Amendment (Real Time Pricing) 2022.
Clause 13.204(1)(b)(ii): amended, on 15 May 2014, by clause 64(b) of the Electricity Industry Participation (Modified Dispatchable Demand) Code Amendment 2013.
Clause 13.204(1)(b)(ii): amended, on 23 February 2015, by clause 75 of the Electricity Industry Participation Code Amendment (Distributed Generation) 2014.
Clause 13.204(1)(b)(ii): amended, on 5 October 2017, by clause 441 of the Electricity Industry Participation Code Amendment (Code Review Programme) 2017.
Clause 13.204(1)(c): amended, on 21 September 2012, by clause 29 of the Electricity Industry Participation (Minor Amendments) Code Amendment 2012.
Clause 13.204(1)(c): amended, on 1 November 2022, by clause 148(4) of the Electricity Industry Participation Code Amendment (Real Time Pricing) 2022.
Clause 13.204(1)(d): amended, on 1 November 2022, by clause 148(5) of the Electricity Industry Participation Code Amendment (Real Time Pricing) 2022.
Clause 13.204(3): inserted, on 1 November 2022, by clause 148(6) of the Electricity Industry Participation Code Amendment (Real Time Pricing) 2022.
Clause 13.204(1)(aa): amended, on 1 March 2024, by clause 82 of the Electricity Industry Participation Code Amendment (Code Review Programme) 2024.

13.205 Calculation of constrained on amounts attributable to system operator

If a **constrained on situation** occurs during a **trading period** in a previous **billing period**, and the **clearing manager** receives notice of the **constrained on situation** under clause 13.76, the **clearing manager** must determine the portion of the **constrained on amounts** calculated under clause 13.204 attributable to the **system operator** for each **generator** or each **ancillary service agent** as follows:

- (a) if the **system operator** has advised the **clearing manager** that a **voltage support** or other **constrained on situation** occurred (including but not limited to **over frequency reserve** and **instantaneous reserve**) the **system operator** must be allocated the total **constrained on amount** for that **trading period**;
- (b) if the **system operator** has advised the **clearing manager** that a non-security **constrained on situation** occurred the **system operator** must be allocated a **constrained on amount** calculated in accordance with the following formula:

$$SOCONNS_{go} = TCONP * (SOQ_{conns} / TQ_{con})$$

where

$SOCONNS_{go}$ is the **constrained on amount** attributable to the **system operator** for that non-security **constrained on situation**

$TCONP$ is the total **constrained on payment** for that **trading period**

SOQ_{conns} is the non-security quantity that was constrained on and advised to the **clearing manager** by the **system operator** under clause 13.76, or the total quantity constrained on, whichever is less

TQ_{con} is the total quantity constrained on:

- (c) if the **system operator** has advised the **clearing manager** that a **frequency keeping** situation occurred the **system operator** must be allocated a **constrained on amount** calculated in accordance with the following formula:

$$\text{SOCONFK}_{\text{go}} = \text{TCONP} * (\text{SOQconfk} / \text{TQcon})$$

where

$\text{SOCONFK}_{\text{go}}$ is the **constrained on amount** attributable to the **system operator** for that **frequency keeping constrained on situation**

TCONP is the total constrained on payment for the **generator** for the **trading period**

SOQconfk is the **frequency keeping** quantity that was advised to the **clearing manager** by the **system operator** under clause 13.76 , or the total quantity constrained on for the **generator**, whichever is less

TQcon is the total quantity constrained on for the **generator**.

Compare: Electricity Governance Rules 2003 rule 5.4 section V part G
Clause 13.205: amended, on 15 May 2014, by clause 65 of the Electricity Industry Participation (Modified Dispatchable Demand) Code Amendment 2013.
Clause 13.205: amended, on 5 October 2017, by clause 442 of the Electricity Industry Participation Code Amendment (Code Review Programme) 2017.
Clause 13.205: amended, on 1 November 2022, by clause 149(1) of the Electricity Industry Participation Code Amendment (Real Time Pricing) 2022.
Clause 13.205(c): amended, on 1 November 2022, by clause 149(2) of the Electricity Industry Participation Code Amendment (Real Time Pricing) 2022.

13.206 Timeframe for calculating constrained on amounts

Each **billing period**, the **clearing manager** must calculate **constrained on amounts** for the previous **billing period** in accordance with clauses 13.204 and 13.205 by the later of—

- (a) 1600 hours on the 8th **business day** of the **billing period** after the previous **billing period**; and
- (b) 1600 hours on the 1st **business day** after the **clearing manager** receives the information required to calculate **constrained on amounts**.

Compare: Electricity Governance Rules 2003 rule 5.5 section V part G
Clause 13.206 Heading: amended, on 5 October 2017, by clause 443(1) of the Electricity Industry Participation Code Amendment (Code Review Programme) 2017.
Clause 13.206: substituted, on 15 May 2014, by clause 4 of the Electricity Industry Participation (Time Frames for Invoicing) Code Amendment 2014.
Clause 13.206(b): replaced, on 5 October 2017, by clause 443(2) of the Electricity Industry Participation Code Amendment (Code Review Programme) 2017.
Clause 13.206: replaced, on 1 November 2018, by clause 93 of the Electricity Industry Participation Code Amendment (Code Review Programme) 2018.

13.207 Clearing manager to send constrained on information to system operator

- (1) The **clearing manager** must, at the time specified in clause 13.206, send to the **system operator** the details of **constrained on amounts** that are attributed to the **system operator** (but limited to information about those **constrained on amounts** that is in the

possession of the **clearing manager**) and the constrained on quantities (in **MW**) calculated in accordance with clause 13.205 for the previous **billing period**.

- (2) The information must be provided to the **system operator** in the manner and format agreed between the **clearing manager** and the **system operator** from time to time.

Compare: Electricity Governance Rules 2003 rule 5.6 section V part G

13.208 Clearing manager to make details of constrained on amounts available

The **clearing manager** must, at the time specified in clause 13.206, **publish** the details of **constrained on amounts** in relation to each **generator, ancillary service agent, and dispatched purchaser** for the previous **billing period** calculated in accordance with clauses 13.204 and 13.205 as follows:

- (a) the aggregate **constrained on amounts** calculated under clauses 13.204 and 13.205:
- (b) the **generator, ancillary service agent, or dispatched purchaser** (as the case may be) that was constrained on:
- (c) the applicable **grid injection point, grid exit point, block dispatch group, or station dispatch group**.

Compare: Electricity Governance Rules 2003 rule 5.7 section V part G

Clause 13.208 Heading: amended, on 5 October 2017, by clause 444(1) of the Electricity Industry Participation Code Amendment (Code Review Programme) 2017.

Clause 13.208: amended, on 15 May 2014, by clause 66 of the Electricity Industry Participation (Modified Dispatchable Demand) Code Amendment 2013.

Clause 13.208: amended, on 5 October 2017, by clause 444(2) of the Electricity Industry Participation Code Amendment (Code Review Programme) 2017.

Clause 13.208: amended, on 1 March 2024, by clause 83 of the Electricity Industry Participation Code Amendment (Code Review Programme) 2024.

13.209 Authority, generators, ancillary service agents, and purchasers have rights to constrained on information

- (1) In addition to the information the **clearing manager** makes available under clause 13.208, the **Authority**, or a **generator, ancillary service agent, or purchaser** who reasonably believes it was adversely affected by a **constrained on situation** occurring, may request information from the **system operator** about the cause of the **constrained on situation**.
- (2) The **system operator** must comply with any reasonable request for such information except that the information must not include any information that is confidential in respect of any other **generator, ancillary service agent, or purchaser**.

Compare: Electricity Governance Rules 2003 rule 5.8 section V part G

Clause 13.209(1): amended, on 5 October 2017, by clause 445 of the Electricity Industry Participation Code Amendment (Code Review Programme) 2017.

13.210 [Revoked]

Compare: Electricity Governance Rules 2003 rule 5.9 section V part G

Clause 13.210: revoked, on 5 October 2017, by clause 446 of the Electricity Industry Participation Code Amendment (Code Review Programme) 2017.

13.211 Backup procedures if the clearing manager's external system is unavailable

- (1) If the **clearing manager's** external system is unavailable for the purposes of making information available under clauses 13.199 and 13.208, the **clearing manager** must

follow backup procedures agreed between it and the **Authority** and **published** by the **Authority**.

(2) *[Revoked]*

Compare: Electricity Governance Rules 2003 rules 5.10 and 5.11 section V part G

Clause 13.211: replaced, on 5 October 2017, by clause 447 of the Electricity Industry Participation Code Amendment (Code Review Programme) 2017.

Clause 13.211 Heading: amended, on 1 March 2024, by clause 84(1) of the Electricity Industry Participation Code Amendment (Code Review Programme) 2024.

Clause 13.211(1): amended, on 1 March 2024, by clause 84(2) of the Electricity Industry Participation Code Amendment (Code Review Programme) 2024.

Clause 13.211(2): revoked, on 1 March 2024, by clause 84(3) of the Electricity Industry Participation Code Amendment (Code Review Programme) 2024.

13.212 Payment of constrained on compensation

(1) For each **trading period**,—

- (a) a **generator** or **ancillary service agent** is owed **constrained on compensation** for **constrained on amounts** determined under clauses 13.204 and 13.205; and
- (b) a **dispatched purchaser** is owed **constrained on compensation** for **constrained on amounts** determined under clause 13.204.

(1A) **Constrained on compensation** for each **dispatch-capable load station** is an amount owing to the **dispatched purchaser** that purchased **electricity** for the **dispatch-capable load station**.

(2) The **system operator** must pay to a **generator**, or **ancillary service agent** any **constrained on amount** calculated under clause 13.205.

(3) The **clearing manager** must advise each **generator**, **ancillary service agent**, and **dispatched purchaser** of the amount owing to the **generator**, **ancillary service agent**, or **dispatched purchaser** for **constrained on compensation** for a **billing period** when the **clearing manager** advises amounts owing under subpart 4 of Part 14.

(4) *[Revoked]*

(5) Each **purchaser** that purchases **electricity** at a **grid exit point** incurs an amount owing to the **clearing manager** for **constrained on compensation**, calculated under subclause (7).

(5A) *[Revoked]*

(6) **Instantaneous reserve constrained on compensation** is an **instantaneous reserve** cost that must be allocated in accordance with clauses 8.59 to 8.66.

(7) The **clearing manager** must calculate **constrained on compensation** for each **trading period** using the following formula:

$$\text{COC}_p = (\text{COC}_g - \text{COC}_{so}) * (P_q / \text{TP}_q)$$

where

COC_p is the **constrained on compensation** owing by a **purchaser**

COC_g is the sum of **constrained on compensation** owing to all **generators** and all **dispatched purchasers** for the **trading period** calculated in accordance with clause 13.204(1)(a) and 13.204(1)(aa)

- COC_{so} is the sum of **constrained on compensation** for that **trading period** payable by the **system operator** to **generators** under subclause (2)
- P_q is the total **electricity** purchased by that **purchaser** from the **clearing manager** during the **trading period** as shown by the **reconciliation information** calculated by the **reconciliation manager** under Part 15
- TP_q is the total **electricity** purchased by all **purchasers** from the **clearing manager** during the **trading period** as shown by **reconciliation information** calculated by the **reconciliation manager** under Part 15.

- (8) The **clearing manager** must advise each **purchaser** of the amount owing by the **purchaser** for **constrained on compensation** for a **billing period** when the **clearing manager** advises amounts owing under subpart 4 of Part 14.

Compare: Electricity Governance Rules 2003 rule 6 section V part G

Clause 13.212(1): substituted, on 15 May 2014, by clause 67(a) of the Electricity Industry Participation (Modified Dispatchable Demand) Code Amendment 2013.

Clause 13.212(1): amended, on 24 March 2015, by clause 13(a) of the Electricity Industry Participation (Settlement and Prudential Security) Code Amendment 2013.

Clause 13.212(1A): inserted, on 15 May 2014, by clause 67(a) of the Electricity Industry Participation (Modified Dispatchable Demand) Code Amendment 2013.

Clause 13.212(1A): amended, on 24 March 2015, by clause 13(b) of the Electricity Industry Participation (Settlement and Prudential Security) Code Amendment 2013.

Clause 13.212(3) & (4): amended, on 15 May 2014, by clause 67(b) & (c) of the Electricity Industry Participation (Modified Dispatchable Demand) Code Amendment 2013.

Clause 13.212(3): substituted, on 24 March 2015, by clause 13(c) of the Electricity Industry Participation (Settlement and Prudential Security) Code Amendment 2013.

Clause 13.212(4): revoked, on 24 March 2015, by clause 13(d) of the Electricity Industry Participation (Settlement and Prudential Security) Code Amendment 2013.

Clause 13.212(5): substituted, on 15 May 2014, by clause 67(d) of the Electricity Industry Participation (Modified Dispatchable Demand) Code Amendment 2013.

Clause 13.212(5): substituted, on 24 March 2015, by clause 13(e) of the Electricity Industry Participation (Settlement and Prudential Security) Code Amendment 2013.

Clause 13.212(5A): inserted, on 15 May 2014, by clause 67(d) of the Electricity Industry Participation (Modified Dispatchable Demand) Code Amendment 2013.

Clause 13.212(5A): revoked, on 24 March 2015, by clause 13(f) of the Electricity Industry Participation (Settlement and Prudential Security) Code Amendment 2013.

Clause 13.212(7): amended, on 15 May 2014, by clause 67(e) of the Electricity Industry Participation (Modified Dispatchable Demand) Code Amendment 2013.

Clause 13.212(7): amended, on 24 March 2015, by clause 13(g) of the Electricity Industry Participation (Settlement and Prudential Security) Code Amendment 2013.

Clause 13.212(8): substituted, on 24 March 2015, by clause 13(h) of the Electricity Industry Participation (Settlement and Prudential Security) Code Amendment 2013.

No payment of constrained on and off compensation for frequency keeping

Cross heading: inserted, on 1 May 2016, by clause 4 of the Electricity Industry Participation Code Amendment (Removal of In-band Frequency Keeping Compensation) 2015.

13.212A No payment of constrained on and off compensation for frequency keeping

- (1) Despite clause 13.192 to clause 13.212, the **system operator** must not pay a **frequency keeping ancillary service agent**—
- (a) **constrained on compensation** in respect of any **constrained on situation**; or
- (b) **constrained off compensation** in respect of any **constrained off situation**.
- (2) Subclause (1) applies in respect of any **reconciled quantity** of **electricity** the **frequency keeping ancillary service agent** produces—
- (a) while providing **frequency keeping**; and

- (b) between—
- (i) the level of **active power** (expressed in **MW**) dispatched in a **trading period** to the **ancillary service agent's generating plant**; and
 - (ii) the level of **active power** (expressed in **MW**) generated by the **ancillary service agent's generating plant** in a **trading period**, measured by a **metering installation**.

Clause 13.212A: inserted, on 1 May 2016, by clause 4 of the Electricity Industry Participation Code Amendment (Removal of In-band Frequency Keeping Compensation) 2015.

No payment of constrained on compensation for generators at maximum ramp down rate

Cross heading: inserted, on 26 March 2020, by clause 4 of the Electricity Industry Participation Code Amendment (Removal of Constrained on Compensation for Ramp Constrained Generators) 2020.

13.212B No payment of constrained on compensation for generators at maximum ramp down rate

- (1) Despite clause 13.202 to clause 13.212, the **clearing manager** must not pay a **generator constrained on compensation** in respect of any **constrained on situation**.
- (2) Subclause (1) applies in respect of any **reconciled quantity** of **electricity** the **generator's generating unit** produces in a **trading period**, only if:
 - (a) the **generating unit** is reducing generation as a result of the **generator** having received a **dispatch instruction** for the **trading period** or part of the **trading period**; and
 - (b) the **dispatch instruction** requires the **generating unit** to reduce generation at the **generating unit's** maximum ramp down rate.

Clause 13.212B: inserted, on 26 March 2020, by clause 4 of the Electricity Industry Participation Code Amendment (Removal of Constrained on Compensation for Ramp Constrained Generators) 2020.

Pricing manager's reporting obligations [Revoked]

Cross heading: revoked, on 1 November 2022, by clause 150 of the Electricity Industry Participation Code Amendment (Real Time Pricing) 2022.

13.213 [Revoked]

Compare: Electricity Governance Rules 2003 rule 7.1 section V part G
Clause 13.213(1) and 2(a): amended, on 5 October 2017, by clause 448 of the Electricity Industry Participation Code Amendment (Code Review Programme) 2017.
Clause 13.213: revoked, on 1 November 2018, by clause 94 of the Electricity Industry Participation Code Amendment (Code Review Programme) 2018.

13.214 [Revoked]

Compare: Electricity Governance Rules 2003 rule 7.2 section V part G
Clause 13.214 Heading: amended, on 5 October 2017, by clause 449(1) of the Electricity Industry Participation Code Amendment (Code Review Programme) 2017.
Clause 13.214(1): amended, on 5 October 2017, by clause 449(2)(a) of the Electricity Industry Participation Code Amendment (Code Review Programme) 2017.
Clause 13.214(2): revoked, on 5 October 2017, by clause 449(2)(b) of the Electricity Industry Participation Code Amendment (Code Review Programme) 2017.
Clause 13.214: revoked, on 1 November 2018, by clause 95 of the Electricity Industry Participation Code Amendment (Code Review Programme) 2018.

13.215 [Revoked]

Compare: Electricity Governance Rules 2003 rule 7.3 section V part G
Clause 13.215(1): amended, on 5 October 2017, by clause 450 of the Electricity Industry Participation Code Amendment (Code Review Programme) 2017.

Clause 13.215(1): replaced, on 1 November 2018, by clause 96 of the Electricity Industry Participation Code Amendment (Code Review Programme) 2018.

Clause 13.215(1): amended, on 20 December 2021, by clause 60 of the Electricity Industry Participation Code Amendment (Code Review Programme) 2019.

Clause 13.215: revoked, on 1 November 2022, by clause 151 of the Electricity Industry Participation Code Amendment (Real Time Pricing) 2022.

13.216 *[Revoked]*

Compare: Electricity Governance Rules 2003 rule 7.4 section V part G

Clause 13.216: amended, on 5 October 2017, by clause 451 of the Electricity Industry Participation Code Amendment (Code Review Programme) 2017.

Clause 13.216: revoked, on 19 September 2019, by clause 4 of the Electricity Industry Participation Code Amendment (Revocation of Requirement to Provide Daily Situation Report) 2019.

Subpart 5—Hedge arrangement disclosure

13.217 Contents of this subpart

This subpart provides for the disclosure of information about **risk management contracts**, which may be **contracts for differences**, **fixed-price physical supply contracts** or **options contracts**, in order to—

- (a) facilitate the ready comparison of **electricity** prices and other key terms of **risk management contracts**; and
- (b) address the lack of information available to persons to formulate their own historic contract curves for **electricity**; and
- (c) provide a more informed basis for persons to assess the competitiveness of the market for **risk management contracts** in respect of **electricity**.

Compare: Electricity Governance Rules 2003 rule 1 section VI part G

13.218 Parties required to submit information

- (1) The following **parties to risk management contracts** are required to submit the information specified in clauses 13.219, 13.222 and 13.223 using an **approved system**:
 - (a) the **seller**, if the **seller** is a **participant**; or
 - (b) the **buyer**, if the **buyer** is a **participant** and the **seller** is not a **participant**.
- (2) Despite subclause (1), a **party** specified in that subclause may, at the **Authority's** discretion, not be required to submit certain information specified in clauses 13.219, 13.222 and 13.223 using an **approved system** if the **Authority** is satisfied that appropriate consent and arrangements are in place under clause 13.236AA for the **Authority** to obtain such information directly from an exchange and the **Authority** has advised that **party** in writing—
 - (a) that this subclause applies; and
 - (b) what information that **party** is not required to submit.

Compare: Electricity Governance Rules 2003 rule 2 section VI part G

Clause 13.218(2): inserted, on 29 October 2020, by clause 5 of the Electricity Industry Participation Code Amendment (Securing Access to Exchange Data) 2020.

Clause 13.218: amended, on 5 October 2017, by clause 452 of the Electricity Industry Participation Code Amendment (Code Review Programme) 2017.

Clause 13.218(a): amended, on 21 September 2012, by clause 30 of the Electricity Industry Participation (Minor Amendments) Code Amendment 2012.

Clause 13.218(2): amended, on 1 March 2024, by clause 85 of the Electricity Industry Participation Code Amendment (Code Review Programme) 2024.

13.219 Information that must be submitted

- (1) The following information must be submitted to the **approved system** in relation to every **options contract**:
 - (a) the **trade date**:
 - (b) the **effective date**:
 - (c) the **end date**:
 - (d) the **quantity**.
- (2) The following information must be submitted to the **approved system** in relation to each **contract for differences** or **fixed-price physical supply contract**:
 - (a) whether the contract is a **contract for differences** or a **fixed-price physical supply contract**:
 - (b) the **trade date**:
 - (c) the **effective date**:
 - (d) the **end date**:
 - (e) the **quantity**:
 - (f) whether or not the contract applies to all **trading periods** within its **term**:
 - (g) whether there is an **adjustment clause**:
 - (h) whether there is a **force majeure clause**:
 - (i) whether there is a **suspension clause**:
 - (j) whether there are any other clauses providing for the pass-through of certain costs, levies or tax or some form of carbon-related cost.
- (3) In addition to the information that must be submitted in accordance with subclause (2), the following information must be submitted to the **approved system** in relation to each **contract for differences**:
 - (a) whether there is a **special credit clause**:
 - (b) whether the volume of **electricity**, in respect of which payments are required to be made by the **floating-price payer**, is flat or varies for different **trading periods**:
 - (c) whether the contract has been traded on the EnergyHedge platform. The EnergyHedge platform is a centralised trading platform for standardised derivative contracts on **electricity** prices in New Zealand:
 - (d) whether the contract has been prepared based on the standardised schedule, which can be adopted in conjunction with the International Swaps and Derivatives Association Master Agreement, as may be available on EnergyHedge.
- (4) In addition to the information that must be submitted in accordance with subclauses (2) and (3), the following information must be submitted to the **approved system** in relation to each **contract for differences** that has a **term** of less than 10 years and each **fixed-price physical supply contract** that has a **term** of less than 10 years:
 - (a) the **contract price** calculated in accordance with clause 13.220:
 - (b) the **grid zone area** in which the **contract price** is determined or applies.
- (5) The information specified in this clause must be submitted in the form specified by the **Authority** and in accordance with clause 13.225(1).
- (6) If a **seller** and a **buyer** enter into a **contract for differences** or **fixed-price physical supply contract** that includes more than 1 **contract price schedule**, the **party** required

to submit information in accordance with clause 13.218 must do so in accordance with 1 of the following methods:

- (a) if the contract includes **contract price schedules** relating to more than 1 **grid zone area**, by combining the information relating to all **contract price schedules** within each **grid zone area** and submitting that combined information to the **approved system** as if there were 1 contract for each **grid zone area**:
 - (b) if the contract includes **contract price schedules** relating to more than 1 **node**, by combining the information relating to all **contract price schedules** at each **node** and submitting the combined information to the **approved system** as if there were 1 contract for each **node**:
 - (c) if the **party** does not wish to combine the information in accordance with paragraphs (a) and (b), by submitting the information for each **contract price schedule** to the **approved system** individually, as though each **contract price schedule** was a separate contract.
- (7) To avoid doubt, if a **contract for differences** or **fixed-priced physical supply contract** includes an **adjustment clause**,—
- (a) the information that must be disclosed in accordance with this clause, in relation to the contract, must only be disclosed once; and
 - (b) the **contract price** to be disclosed in accordance with subclause (4) is that which first applies under the contract.

Compare: Electricity Governance Rules 2003 rule 3 section VI part G
Clause 13.219(1), (2), (3), (4) and (6): amended, on 5 October 2017, by clause 453 of the Electricity Industry Participation Code Amendment (Code Review Programme) 2017.

13.220 Calculation of contract price

- (1) The **contract price** to be submitted for the purposes of clause 13.219(4)(a) and (6) is to be calculated in accordance with the following formula:

$$CP = \left(\frac{\sum_{i=1}^n P_i \times TP_i}{\sum_{i=1}^n TP_i} \right) / LF \times LAF$$

where

CP is the **contract price**

n is the number of different prices within the contract

P_i is the price specified in the contract

TP_i is the number of **trading periods** during which each price in the contract applies

LF is the **location factor**, for the relevant **node** at which the price is set in the contract, as **published** by the **Authority** in accordance with clause 13.221

LAF means a loss adjustment factor, which is,—

- (a) if the **contract price** for the contract is referenced to a **point of connection** on the **grid**, 1; or
 - (b) for all other contracts, 0.937 (being the difference between 1 and the loss factor of 0.063).
- (2) The **Authority** may issue guidelines on the **approved system** to provide assistance to **sellers** and **buyers** in determining what information must be submitted to the **approved system**, which may include clarification as to how to apply the formula in subclause (1) in the circumstances covered by clause 13.219(6).

Compare: Electricity Governance Rules 2003 rule 4 section VI part G

Clause 13.220(2): amended, on 5 October 2017, by clause 454 of the Electricity Industry Participation Code Amendment (Code Review Programme) 2017.

13.221 Node and grid zone area information

- (1) The **WITS manager** must **publish** annually,—
- (a) a list of all **nodes** at which the **clearing manager** makes **final prices** available on **WITS**; and
 - (b) a corresponding **location factor** for each such **node**; and
 - (c) a corresponding **grid zone area** for each such **node**; and
 - (d) a list of nominated **zone nodes**, being 1 **node** at which the **clearing manager** makes **final prices** available on **WITS**, within each **grid zone area**.
- (2) For the purposes of subclause (1)(b), the **location factor** for each such **node** must be calculated as follows:

$$LF = A/B$$

where

A is the average **final price** made available on **WITS** at that **node** over the 12 month period preceding the month before the date on which the **location factors** are **published**

B is the average **final price** made available on **WITS** at the relevant nominated **zone node**, as **published** in accordance with subclause (1)(d), for the 12 month period preceding the month before the date on which the **location factors** are **published**

LF is the **location factor** to be **published** in accordance with subclause (1)(b).

Compare: Electricity Governance Rules 2003 rule 5 section VI part G

Clause 13.221(1) and (2): amended, on 5 October 2017, by clause 455 of the Electricity Industry Participation Code Amendment (Code Review Programme) 2017.

Clause 13.221(1)(a) and (d): amended, on 1 November 2022, by clause 152 of the Electricity Industry Participation Code Amendment (Real Time Pricing) 2022.

13.222 Other information that must be submitted

- (1) The following information must be submitted to the **approved system** in relation to every **risk management contract**:
 - (a) each **party's** legal name;
 - (b) each **party's** email address for notice.
- (2) The information must be submitted in accordance with clause 13.225(1).

Compare: Electricity Governance Rules 2003 rule 6 section VI part G

Clause 13.222(1): amended, on 5 October 2017, by clause 456 of the Electricity Industry Participation Code Amendment (Code Review Programme) 2017.

13.223 Modified or amended information

- (1) If a modification or amendment is made to a **risk management contract**, after the information referred to in clauses 13.219 or 13.222 has been submitted to the **approved system**, and the effect of the modification or amendment is that the information submitted to the **approved system** is no longer correct or complete, the modified or amended information must be submitted to the **approved system**.
- (2) The information submitted under subclause (1) must—
 - (a) identify in each case the information that has been modified or amended; and
 - (b) be in the form specified by the **Authority**; and
 - (c) be submitted in accordance with clause 13.225(2).

Compare: Electricity Governance Rules 2003 rule 7 section VI part G

Clause 13.223(1): amended, on 5 October 2017, by clause 457 of the Electricity Industry Participation Code Amendment (Code Review Programme) 2017.

13.224 Correction of information

Except when clause 13.223 applies, if a **party** to a **risk management contract** discovers that information previously submitted to the **approved system** about that **risk management contract** is incorrect or incomplete, that **party** must—

- (a) seek to agree with the **other party** to the **risk management contract** that the information is incorrect or incomplete and how it should be corrected; and
- (b) when both **parties** have agreed that the incorrect or incomplete information should be corrected, submit the corrected information to the **approved system** in accordance with clause 13.225(3).

Compare: Electricity Governance Rules 2003 rule 8 section VI part G

Clause 13.224: amended, on 5 October 2017, by clause 458 of the Electricity Industry Participation Code Amendment (Code Review Programme) 2017.

13.225 Timeframes for submitting information

- (1) The information specified in clauses 13.219 and 13.222 must be submitted to the **approved system**—
 - (a) in respect of a **contract for differences** or an **options contract**, no later than 5pm, 5 **business days** after the **trade date**; and
 - (b) for any other type of **risk management contract**, no later than 5pm, 10 **business days** after the **trade date**.

- (2) The modified or amended information submitted under clause 13.223(1) must be submitted to the **approved system** no later than 5pm, **5 business days** after the amendment or modification to the **risk management contract** is made.
- (3) A **participant** that discovers under clause 13.224 that information it submitted to the **approved system** is incorrect or incomplete must submit the corrected information to the **approved system** no later than 5pm, **2 business days** after both **parties** to the **risk management contract** have agreed how the incorrect or incomplete information should be corrected.
- (4) The corrected information submitted in accordance with clause 13.227(8) must be submitted to the **approved system** no later than 5pm, **2 business days** after the **parties** to the **risk management contract** have agreed, in accordance with clause 13.227(5)(b), that the information made available under clause 13.226(1) is not correct, and corrected the information accordingly.

Compare: Electricity Governance Rules 2003 rule 9 section VI part G

Clause 13.225(1) to (4): amended, on 5 October 2017, by clause 459 of the Electricity Industry Participation Code Amendment (Code Review Programme) 2017.

13.226 WITS manager must make certain information available to the public

- (1) The **WITS manager** must, as soon as practicable, make the information submitted under clauses 13.219, 13.223(1), and 13.224 available at no cost on a publicly accessible **approved system**.
- (2) At the same time that it makes the submitted information available in accordance with subclause (1), for all information other than that submitted under clause 13.224, the **WITS manager** must—
 - (a) indicate on the **approved system** that the information is unverified; and
 - (b) if the contract is a **contract for differences** or an **options contract**, give a written notice to the **other party** to the contract—
 - (i) (if the **other party** is a **participant**) requiring the **other party** to submit a **verification notice** to the **approved system** within **2 business days** of receiving the notice confirming whether or not the information is correct; or
 - (ii) (if the **other party** is not a **participant**) giving the **other party** the option to submit a **verification notice** to the **approved system** within **2 business days** of receiving the notice confirming whether or not the information is correct; or
 - (c) if the contract is a **fixed-price physical supply contract**, give a written notice to the **other party** giving the **other party** the option to submit a **verification notice** to the **approved system** within **2 business days** confirming whether or not the information is correct.
- (3) A **participant** that receives a **verification notice** under subclause (2)(b)(i) must comply with the written notice.

Compare: Electricity Governance Rules 2003 rule 10 section VI part G

Clause 13.226 Heading: replaced, on 5 October 2017, by clause 460(1) of the Electricity Industry Participation Code Amendment (Code Review Programme) 2017.

Clause 13.226(1): replaced, on 5 October 2017, by clause 460(2) of the Electricity Industry Participation Code Amendment (Code Review Programme) 2017.

Clause 13.226(2): amended, on 5 October 2017, by clause 460(3) of the Electricity Industry Participation Code Amendment (Code Review Programme) 2017.

Clause 13.226(3): amended, on 5 October 2017, by clause 460(4) of the Electricity Industry Participation Code Amendment (Code Review Programme) 2017.

13.227 Verification of information

- (1) If the **other party** to a **risk management contract** submits a **verification notice** to the **approved system** within 2 **business days** of receiving notice under clause 13.226(2) confirming that the information made available under clause 13.226(1) is correct, the **WITS manager** must indicate that the information made available under clause 13.226(1) is verified.
- (2) The **WITS manager** must indicate on the **approved system** that the information made available under clause 13.226(1) is not disputed, if—
 - (a) the **other party** to a **contract for differences** or an **options contract** is not a **participant** and does not submit a **verification notice** to the **approved system** within 2 **business days** of receiving notice under clause 13.226(2)(b)(ii); or
 - (b) the **other party** to a **fixed-price physical supply contract** does not submit a **verification notice** to the **approved system** within 2 **business days** of receiving notice under clause 13.226(2)(c).
- (3) If the **other party** to a **risk management contract** submits a **verification notice** to the **WITS manager** within 2 **business days** of receiving notice under clause 13.226(2) advising that the information made available under clause 13.226(1) is not correct, the **approved system** must indicate that the information is disputed.
- (4) If the **other party** to a **contract for differences** or an **options contract** is a **participant** but does not submit a **verification notice** within 2 **business days** of receiving notice in accordance with clause 13.226(2)(b)(i), the **WITS manager** must—
 - (a) indicate on the **approved system** that the information made available in accordance with clause 13.226(1) is pending verification; and
 - (b) give the **other party** a written reminder notice requiring the **other party** to submit a **verification notice** as soon as possible.
- (5) If the information made available under clause 13.226(1) is disputed, the **WITS manager** must—
 - (a) indicate on the **approved system** that the information is disputed; and
 - (b) give the **parties** to the relevant **risk management contract** a written notice requiring the **parties** to use all reasonable endeavours to agree on whether the information submitted in accordance with clause 13.225(1) is correct or not within 10 **business days** of receiving the notice.
- (6) The **parties** must comply with any notice given under subclauses (4)(b) or (5)(b).
- (7) If the **parties** to the **risk management contract** agree in accordance with subclause (5)(b) that the information made available in accordance with clause 13.226(1) is correct, the **other party** must submit a **verification notice** to the **approved system** within 1 **business day** confirming that the information is correct.
- (8) If the **parties** to a **risk management contract** agree in accordance with subclause (5)(b) that the information made available in accordance with clause 13.226(1) is not correct, the **party** that submitted that information to the **approved system** must correct that information in accordance with clause 13.225(4).

- (9) If, within 10 **business days** of receiving the notice sent in accordance with subclause (5)(b), the **parties** to the relevant **risk management contract** are not able to agree whether or not the information made available in accordance with clause 13.226(1) is correct, despite using all reasonable endeavours, the **WITS manager** must indicate on the **approved system** that the information is subject to a long term dispute.

Compare: Electricity Governance Rules 2003 rule 11 section VI part G

Clause 13.227(1): amended, on 5 October 2017, by clause 461(1) and (2) of the Electricity Industry Participation Code Amendment (Code Review Programme) 2017.

Clause 13.227(2): amended, on 5 October 2017, by clause 461(2) and (3) of the Electricity Industry Participation Code Amendment (Code Review Programme) 2017.

Clause 13.227(3): amended, on 5 October 2017, by clause 461(2) and (4) of the Electricity Industry Participation Code Amendment (Code Review Programme) 2017.

Clause 13.227(4): amended, on 5 October 2017, by clause 461(2), (5) and (6) of the Electricity Industry Participation Code Amendment (Code Review Programme) 2017.

Clause 13.227(5): amended, on 5 October 2017, by clause 461(2), (6) and (7) of the Electricity Industry Participation Code Amendment (Code Review Programme) 2017.

Clause 13.227(6): amended, on 5 October 2017, by clause 461(8) of the Electricity Industry Participation Code Amendment (Code Review Programme) 2017.

Clause 13.227(7): amended, on 5 October 2017, by clause 461(2) and (9) of the Electricity Industry Participation Code Amendment (Code Review Programme) 2017.

Clause 13.227(8): amended, on 5 October 2017, by clause 461(2) and (9) of the Electricity Industry Participation Code Amendment (Code Review Programme) 2017.

Clause 13.227(9): amended, on 5 October 2017, by clause 461(10) of the Electricity Industry Participation Code Amendment (Code Review Programme) 2017.

13.228 Confirmation of information submitted through approved system

- (1) The **WITS manager** must, using the **approved system**, confirm receipt of any information received by it under clauses 13.21, or 13.222 to 13.224.
- (2) Each confirmation under subclause (1) must contain a copy of the information received using the **approved system**, together with the date and time of receipt.

Compare: Electricity Governance Rules 2003 rule 12 section VI part G

Clause 13.228 Heading: amended, on 5 October 2017, by clause 462(1) of the Electricity Industry Participation Code Amendment (Code Review Programme) 2017.

Clause 13.228(1): amended, on 5 October 2017, by clause 462(2) of the Electricity Industry Participation Code Amendment (Code Review Programme) 2017.

Clause 13.228(2): amended, on 5 October 2017, by clause 462(3) of the Electricity Industry Participation Code Amendment (Code Review Programme) 2017.

13.229 Submitting party to check if no confirmation received

- (1) If a **party** that submits information to the **approved system** does not receive confirmation from the **WITS manager** under clause 13.228(1) that the **approved system** has received the **party's** information within 6 hours of submitting the information, that **party** must, within 1 **business day** of that 6 hour period ending, contact the **WITS manager** to check whether the **approved system** has received the information.
- (2) If the **approved system** has not received the information, the **party** must resubmit the information.
- (3) This process must be repeated until the **WITS manager** has confirmed receipt of the information from the **party** in accordance with clause 13.228.

Compare: Electricity Governance Rules 2003 rule 13 section VI part G

Clause 13.229(1): replaced, on 5 October 2017, by clause 463(a) of the Electricity Industry Participation Code Amendment (Code Review Programme) 2017.

Clause 13.229(2) and (3): amended, on 5 October 2017, by clause 463(b) and (c) of the Electricity Industry Participation Code Amendment (Code Review Programme) 2017.

13.230 Certification of information

- (1) Each **participant** that has submitted information in accordance with clause 13.225 in a particular year ending 31 March must, within 3 months of the end of the year ending 31 March, certify to the **Authority** that the information submitted was correct.
- (2) The certification provided under subclause (1) must be—
 - (a) *[Revoked]*
 - (b) in the form specified by the **Authority**; and
 - (c) signed and dated by either—
 - (i) a director of the **participant**; or
 - (ii) the **participant's** chief financial officer, or person holding an equivalent position; or
 - (iii) the **participant's** chief executive officer, or person holding an equivalent position.

Compare: Electricity Governance Rules 2003 rule 14 section VI part G

Clause 13.230(1): replaced, on 5 October 2017, by clause 464(1) of the Electricity Industry Participation Code Amendment (Code Review Programme) 2017.

Clause 13.230(2): amended, on 5 October 2017, by clause 464(2)(a) of the Electricity Industry Participation Code Amendment (Code Review Programme) 2017.

Clause 13.230(2)(a): revoked, on 5 October 2017, by clause 464(2)(b) of the Electricity Industry Participation Code Amendment (Code Review Programme) 2017.

Clause 13.230(2)(c): replaced, on 5 October 2017, by clause 464(2)(c) of the Electricity Industry Participation Code Amendment (Code Review Programme) 2017.

13.231 Audit of information

- (1) The **Authority** may, in its discretion, carry out an **audit** as to whether a **participant** has complied with this subpart.
- (2) If the **Authority** decides under subclause (1) that a **participant** should be subject to an **audit**, the **Authority** must first give written notice to the **participant** requiring the **participant** to nominate an appropriate **auditor**. The **participant** must provide that nomination in writing to the **Authority** within a reasonable timeframe. The **Authority** must appoint the **auditor** nominated by the **participant**. If the **participant** fails to nominate an appropriate **auditor** within a reasonable timeframe, the **Authority** may appoint an **auditor** of its own choice.
- (3) A **participant** subject to an **audit** under this clause must, on request from the **auditor**, provide the **auditor** with a copy of every **risk management contract** that it has entered into in the previous 12 months or within such other period specified by the **auditor**. The **participant** must provide this **audit** information no later than 20 **business days** after receiving a request from the **auditor** for the information.
- (4) The **participant** must ensure that the **auditor** provides the **Authority** with an **audit** report on the **participant's** compliance with this subpart that has been prepared in accordance with subclauses (4A) and (5).
- (4A) The **audit** report must include any comments from the **participant** on any non-compliance found by the **auditor** if the **participant** provided comments to the **auditor** within a time specified by the **auditor**.

- (5) The **audit** report must not contain any **risk management contract** that the **participant** has provided to the **auditor** in accordance with subclause (3), unless the **Authority** has specifically requested that the **auditor** do so.

Compare: Electricity Governance Rules 2003 rule 15 section VI part G

Clause 13.231(2): amended, on 5 October 2017, by clause 465 of the Electricity Industry Participation Code Amendment (Code Review Programme) 2017.

Clause 13.231(4): substituted, on 1 February 2016, by clause 86(1) of the Electricity Industry Participation Code Amendment (Code Review Programme) 2015.

Clause 13.231(4A): inserted, on 1 February 2016, by clause 86(1) of the Electricity Industry Participation Code Amendment (Code Review Programme) 2015.

Clause 13.231(5): amended, on 1 February 2016, by clause 86(2) of the Electricity Industry Participation Code Amendment (Code Review Programme) 2015.

13.232 Payment of costs relating to audits

- (1) If an **audit** establishes, to the reasonable satisfaction of the **Authority**, that a **participant** may not have complied with this subpart (whether or not the **Authority** appoints an investigator to investigate the alleged breach), the **participant** must pay for the **audit**.
- (2) If the **Authority** considers that the non-compliance of the **participant** is minor or relates to some (but not all) of the clauses in this subpart, the **Authority** may, in its discretion, make an assessment regarding the proportion of the costs of the **audit** that are to be paid by the **participant**, and those costs must be paid by the **participant**.
- (3) If an **audit** establishes to the reasonable satisfaction of the **Authority** that the **participant** has complied with this subpart, the **participant** is not required to pay any of the **auditor's** costs.

Compare: Electricity Governance Rules 2003 rule 16 section VI part G

13.233 WITS manager and Authority must not publish certain information and may use information only under this subpart

- (1) The **Authority** must keep, and ensure that the **WITS manager** and each **auditor** appointed under clause 13.231(2) keep, information submitted to the **approved system** under clauses 13.219, or 13.222 to 13.224 and copies of any **risk management contract** provided to the **auditor** under clause 13.231 confidential, unless—
- (a) the information is provided by the **Authority** to subcontractors or **service providers** that the **Authority** appoints to provide services for the purposes of this subpart, and those subcontractors or **service providers** have agreed to keep that information confidential, on the same terms as apply to the **Authority** under this clause; or
 - (b) the information is required to be disclosed by law; or
 - (c) the **party** or **parties** to whom the information relates have provided written consent to the disclosure; or
 - (d) any of the information in a **risk management contract** is made available in accordance with clause 13.226(1).
- (2) The **Authority** may use the information submitted under clause 13.222 and copies of a **risk management contract** provided to the **Authority** by an **auditor** appointed under clause 13.231(2) only for purposes related to this subpart and the enforcement of this subpart.

Compare: Electricity Governance Rules 2003 rule 17 section VI part G
Clause 13.233 Heading: amended, on 5 October 2017, by clause 466(1) of the Electricity Industry Participation Code Amendment (Code Review Programme) 2017.
Clause 13.233(1) and (2): amended, on 5 October 2017, by clause 466(2)(a) and (b) of the Electricity Industry Participation Code Amendment (Code Review Programme) 2017.

13.234 No misleading information

A **party** may not submit any information that, at the time the information was submitted, was misleading or deceptive or likely to mislead or deceive.

Compare: Electricity Governance Rules 2003 rule 18 section VI part G

13.235 Risk management contracts must be lawful

A **party** may not submit information if that **party** knows or ought reasonably to know that the **risk management contract** to which that information applies would contravene any law.

Compare: Electricity Governance Rules 2003 rule 19 section VI part G

13.236 Availability of information

The information that is submitted under clauses 13.219, 13.223, or 13.224 may only be removed from the **approved system** after 12 months following the termination of the **risk management contract**.

Compare: Electricity Governance Rules 2003 rule 20 section VI part G
Clause 13.236: amended, on 5 October 2017, by clause 467 of the Electricity Industry Participation Code Amendment (Code Review Programme) 2017.

13.236AA Requirement to provide consent to exchange

- (1) Each **participant** must ensure that, before placing any bid or offer for, or entering into, an exchange-traded **risk management contract**, it has provided the consent described in clause 13.236AA(2) to the exchange through which the bid or offer will be placed or contract entered into, which consent must continue to be in effect at the time any such bid or offer is placed or contract is entered into.
- (2) The consent required under subclause (1) must be in the **prescribed form** and allow the exchange to provide any of the following de-anonymised information (including historical information) to the **Authority** at such frequency as may be required by the **Authority** from time to time:
 - (a) any information, documents or data in relation to bids or offers placed for **risk management contracts**, or in relation to such contracts entered into, by, or on behalf of, the **participant** (including in relation to buy and sell prices, trading periods, volumes and quantities);
 - (b) any information, documents or data in relation to the number of outstanding **risk management contracts** held by, or on behalf of, the **participant** at the end of each **trading day**;
 - (c) where the **participant** has an agreement with an exchange that imposes requirements on the **participant** in relation to the exchange's market-making scheme for **risk management contracts**, any other information, documents or data that the **Authority** may require in relation to the **participant's** performance of its obligations under that agreement.
- (3) Each **participant** must ensure that, immediately after providing consent in accordance with subclause (1), all necessary arrangements are in place with any agent, associate,

contractor, service provider, or other person acting on behalf of, or on the instructions of, the **participant** to permit and facilitate the provision of all information described in subclause (2) by the exchange to the **Authority**.

- (4) Each **participant** must, within **5 business days** of receiving a written request from the **Authority**, supply the **Authority** with such evidence as may be reasonably required by the **Authority** to satisfy itself that the consent and arrangements required by this clause 13.236AA are in full force and effect.
- (5) The **Authority** may issue guidelines to assist **participants** to identify the types of information the **Authority** may obtain from an exchange and the types of arrangements it expects **participants** to put in place to permit and facilitate the provision of such information.

Clause 13.236AA: inserted, on 29 October 2020, by clause 4 of the Electricity Industry Participation Code Amendment (Securing Access to Exchange Data) 2020.

Subpart 5A—Spot price risk disclosure

Subpart 5A: inserted on 1 December 2011, by clause 5 of the Electricity Industry Participation Code (Spot Price Risk Disclosure) Amendment 2011.

13.236A Disclosing participants must prepare and submit spot price risk disclosure statements

- (1) Each **disclosing participant** must prepare a **spot price risk disclosure statement** for each quarter beginning 1 January, 1 April, 1 July, and 1 October in each year.
- (2) Each **participant** who will be a **disclosing participant** in the next quarter must prepare a **spot price risk disclosure statement** for that quarter in accordance with this subpart.
- (3) The **disclosing participant** must submit the **spot price risk disclosure statement** to the person appointed by the **Authority** to receive **spot price risk disclosure statements** no later than **5 business days** before the beginning of the quarter to which the statement relates.
- (4) A **participant** is not required to comply with this clause for a quarter if it is a **disclosing participant** in relation to the quarter only because it is subject to a **wash-up** in that quarter.

Clause 13.236A: inserted on 1 December 2011, by clause 5 of the Electricity Industry Participation Code (Spot Price Risk Disclosure) Amendment 2011.

Clause 13.236A(1) and (2): amended, on 5 October 2017, by clause 468 of the Electricity Industry Participation Code Amendment (Code Review Programme) 2017.

Clause 13.236A(4): inserted, on 1 February 2016, by clause 87 of the Electricity Industry Participation Code Amendment (Code Review Programme) 2015.

13.236B Authority must appoint a person to receive and analyse spot price risk disclosure statements

- (1) The **Authority** must appoint an independent person to receive and analyse **spot price risk disclosure statements**.
- (2) The **Authority** must enter into a contract with the person appointed to receive and analyse **spot price risk disclosure statements**.
- (3) The contract with the person appointed to receive and analyse **spot price risk disclosure statements** must include the following:

- (a) a requirement that the person does not disclose any **spot price risk disclosure statement** to any other person, including that it does not disclose any **spot price risk disclosure statement** to the **Authority**;
- (b) a requirement that the person provide information regarding **spot price risk disclosure statements** to the **Authority** in a form that does not identify the **disclosing participant** to which it relates.

Clause 13.236B: inserted on 1 December 2011, by clause 5 of the Electricity Industry Participation Code (Spot Price Risk Disclosure) Amendment 2011.

13.236C Authority may approve consolidated spot price risk disclosure statements

On application by 1 or more **disclosing participants**, the **Authority** may approve those **disclosing participants** preparing and submitting a consolidated **spot price risk disclosure statement**.

Clause 13.236C: inserted on 1 December 2011, by clause 5 of the Electricity Industry Participation Code (Spot Price Risk Disclosure) Amendment 2011.

13.236D Authority must publish base case, stress test, and method for calculating target cover ratio

- (1) The **Authority** must **publish** a notice setting out the following:
 - (a) a **base case**;
 - (b) 1 or more **stress tests**;
 - (c) 1 or more methods for calculating a **disclosing participant's** target cover ratio.
- (2) If the **Authority** has not **published** a notice under subclause (1) at least 30 **business days** before the start of a quarter in respect of which a **spot price risk disclosure statement** is required to be prepared, a **disclosing participant** is not required to prepare or submit a **spot price risk disclosure statement** for the next quarter.
- (3) If the **Authority publishes** an amendment to a notice, or revokes and replaces a notice, within 30 **business days** before the start of a quarter in respect of which a **spot price risk disclosure statement** is required to be prepared, **disclosing participants** must prepare **spot price risk disclosure statements** for the immediately following quarter in accordance with the notice as in force immediately before the amendment or replacement was made and not in accordance with the notice as amended or replaced.

Clause 13.236D: inserted on 1 December 2011, by clause 5 of the Electricity Industry Participation Code (Spot Price Risk Disclosure) Amendment 2011.

Clause 13.236D Heading: amended, on 5 October 2017, by clause 469(1) of the Electricity Industry Participation Code Amendment (Code Review Programme) 2017.

Clause 13.236D: amended, on 5 October 2017, by clause 469(2) of the Electricity Industry Participation Code Amendment (Code Review Programme) 2017.

13.236E Content of spot price risk disclosure statements

- (1) A **spot price risk disclosure statement** submitted under this subpart must include the following:
 - (a) the **disclosing participant's** annual net cash flow from operating activities as set out in the **disclosing participant's** most recent set of audited annual financial statements;
 - (b) the **disclosing participant's** level of shareholders' equity as set out in the **disclosing participant's** most recent set of audited annual financial statements;

- (c) the **disclosing participant's** estimate of the value of **electricity** that it expects to sell to the **clearing manager** during the period to which the **stress test** relates when the **stress test** is applied, minus the **disclosing participant's** estimate of the value of that **electricity** under the **base case** for that period:
 - (d) the **disclosing participant's** estimate of the value of **electricity** that it expects to purchase from the **clearing manager** during the period to which the **stress test** relates when the **stress test** is applied, minus the **disclosing participant's** estimate of the value of that **electricity** under the **base case** for that period:
 - (e) the **disclosing participant's** estimate of the projected net cash flows from operating activities of the **disclosing participant** during the period to which the **stress test** relates when the **stress test** is applied, minus the **disclosing participant's** estimate of those cash flows under the **base case** for that period:
 - (f) a statement as to whether the **disclosing participant** has an explicit risk management policy in respect of its exposure to the **wholesale market**:
 - (g) if the **disclosing participant** has an explicit risk management policy, the **disclosing participant's** target cover ratio, for each **stress test**, calculated in accordance with the relevant method **published** by the **Authority** under clause 13.236D for the quarter to which the statement relates.
- (1A) Despite subclause (1), a **disclosing participant** is not required to include the information in subclause (1) in its **spot price risk disclosure statement** for a quarter if—
- (a) the **disclosing participant** expects that a change in spot prices would not affect the **disclosing participant's** cash flow from operating activities in the quarter; and
 - (b) the **disclosing participant's spot price risk disclosure statement** for the quarter includes a statement that the **disclosing participant** expects that a change in spot prices would not affect the **disclosing participant's** cash flow from operating activities in the quarter.
- (2) For the purposes of subclause (1),—
- (a) **electricity** is deemed to be sold to the **clearing manager** by a **disclosing participant** if it is sold to the **clearing manager** on the **disclosing participant's** behalf; and
 - (b) **electricity** is deemed to be purchased from the **clearing manager** by a **disclosing participant** if it is purchased from the **clearing manager** on the **disclosing participant's** behalf.
- (3) The **disclosing participant** must ensure that a **spot price risk disclosure statement** is signed and dated by a director, or the chief executive officer, or the chief financial officer, or a person holding a position equivalent to one of those positions, of the **disclosing participant** no earlier than 20 **business days** and no later than 5 **business days** before the beginning of the quarter to which the statement relates.
- (4) In preparing a **spot price risk disclosure statement**, a **disclosing participant** must have regard to all relevant factors, including (without limitation)—
- (a) any financial instruments in which the **disclosing participant** has an interest; and

- (b) any other measures that the **disclosing participant** has in effect to manage the risk arising from its exposure to the **wholesale market**; and
- (c) any other arrangements that the **disclosing participant** has in place to manage that risk; and
- (d) any amounts of **electricity** that the **disclosing participant** expects to buy from, or sell to, the **clearing manager**.

Clause 13.236E: inserted on 1 December 2011, by clause 5 of the Electricity Industry Participation Code (Spot Price Risk Disclosure) Amendment 2011.

Clause 13.236E(1)(g) and (3): amended, on 5 October 2017, by clause 470 of the Electricity Industry Participation Code Amendment (Code Review Programme) 2017.

Clause 13.236E(1A): inserted, on 6 November 2017, by clause 4 of the Electricity Industry Participation Code Amendment (Spot Price Risk Disclosure) 2017.

13.236F Certification of spot price risk disclosure statement

- (1) A **disclosing participant** who has submitted a **spot price risk disclosure statement** in accordance with this subpart must certify to the **Authority**—
 - (a) that the board of the **disclosing participant** has considered—
 - (i) every **spot price risk disclosure statement** submitted under this subpart by the **disclosing participant** in the period to which the certification relates; and
 - (ii) the projected change in net cash flows from operating activities of the **disclosing participant** as a result of applying the **stress test** or **stress tests** that relate to each period to which each **spot price risk disclosure statement** relates; and
 - (b) that the **disclosing participant** has provided to each of the **disclosing participant's** customers who, in the period to which the certification relates, has entered into or renewed a contract with the **disclosing participant** that results in any **electricity** supplied to the customer being determined directly by reference to the **final price** at a **GXP**, information to enable the customer to consider the outcomes of applying the **stress test** or **stress tests** to the customer.
- (2) Each certification must be submitted as follows:
 - (a) in the case of the first certification submitted by a **disclosing participant**, no later than the end of the fourth quarter following the quarter in which the first **spot price risk disclosure statement** is submitted by that **disclosing participant** (in which case the certification must relate to every **spot price risk disclosure statement** made by the **disclosing participant** in the preceding quarters):
 - (b) in the case of every subsequent certification, no later than the end of the fifth quarter following the quarter in which the last certification was submitted (in which case the certification must relate to every **spot price risk disclosure statement** made by the **disclosing participant** since the last certification was submitted).
- (3) Each certification submitted under subclause (2) must be—
 - (a) in the form specified by the **Authority**; and
 - (b) signed and dated by a director of the **disclosing participant** and either—
 - (i) another director of the **disclosing participant**; or

- (ii) the **disclosing participant's** chief executive officer, or person holding an equivalent position; or
- (iii) the **disclosing participant's** chief financial officer, or person holding an equivalent position.

Clause 13.236F: inserted on 1 December 2011, by clause 5 of the Electricity Industry Participation Code (Spot Price Risk Disclosure) Amendment 2011.

Clause 13.236F(1): amended, on 5 October 2017, by clause 471(1) of the Electricity Industry Participation Code Amendment (Code Review Programme) 2017.

Clause 13.236F(2): amended, on 5 October 2017, by clause 471(2) of the Electricity Industry Participation Code Amendment (Code Review Programme) 2017.

Clause 13.236F(3): replaced, on 5 October 2017, by clause 471(3) of the Electricity Industry Participation Code Amendment (Code Review Programme) 2017.

13.236G Authority may require disclosing participant to submit new spot price risk disclosure statement

- (1) The **Authority** may, by notice in writing to a **disclosing participant** who submitted a **spot price risk disclosure statement**, require the **disclosing participant** to submit a new **spot price risk disclosure statement**.
- (2) If a **disclosing participant** receives a request from the **Authority** under subclause (1), the **disclosing participant** must submit a new **spot price risk disclosure statement** to the person appointed by the **Authority** to receive **spot price risk disclosure statements** within 10 **business days** after the date on which the **disclosing participant** received the request.
- (3) Clause 13.236E applies to a **spot price risk disclosure statement** submitted under this clause.

Clause 13.236G: inserted on 1 December 2011, by clause 5 of the Electricity Industry Participation Code (Spot Price Risk Disclosure) Amendment 2011.

Clause 13.236G(2): amended, on 5 October 2017, by clause 472 of the Electricity Industry Participation Code Amendment (Code Review Programme) 2017.

13.236H Authority may require independent audit of spot price risk disclosure statement or certification

- (1) The **Authority** may, in its discretion, on the recommendation of the person appointed to receive and analyse **spot price risk disclosure statements** or on its own motion, require an **audit** of 1 or more of the following:
 - (a) a **spot price risk disclosure statement**;
 - (b) part of a **spot price risk disclosure statement**;
 - (c) the information set out in the certification given under clause 13.236F.
- (2) If the **Authority** requires an **audit** under subclause (1), the **Authority** must require the relevant **disclosing participant** to nominate an appropriate **auditor**.
- (3) The **disclosing participant** must provide that nomination within a reasonable timeframe.
- (4) The **Authority** may direct the **disclosing participant** to appoint the **auditor** nominated by the **disclosing participant**.
- (5) If the **disclosing participant** fails to nominate an appropriate **auditor** within 5 **business days**, the **Authority** may direct the **disclosing participant** to appoint an **auditor** of the **Authority's** choice.

- (6) The **disclosing participant** must appoint an **auditor** in accordance with a direction made under subsection (4) or subsection (5).
- (7) A **disclosing participant** subject to an **audit** under this clause must, on request from the **auditor**, provide the **auditor** with such information as the **auditor** reasonably requires in order to **audit** the **spot price risk disclosure statement** or the information set out in the certification given under clause 13.236F (as the case may be).
- (8) The **disclosing participant** must provide the information no later than 10 **business days** after receiving a request from the **auditor** for the information.
- (9) The **disclosing participant** must ensure that the **auditor** produces an **audit** report on the **spot price risk disclosure statement** or the information set out in the certification given under clause 13.236F (as the case may be) and submits the **audit** report to the **Authority**.
- (10) Before the **audit** report is submitted to the **Authority**, any failure of the **spot price risk disclosure statement** or the information set out in the certification given under clause 13.236F (as the case may be) to comply with this subpart must be referred back to the **disclosing participant** for comment.
- (11) The comments of the **disclosing participant** must be included in the **audit** report.
- (12) The **disclosing participant** may require that the **auditor** does not provide the **Authority** with a copy of any information that the **disclosing participant** has provided to the **auditor** in accordance with subclause (7).

Clause 13.236H Heading: amended, on 5 October 2017, by clause 473(1) of the Electricity Industry Participation Code Amendment (Code Review Programme) 2017.

Clause 13.236H: inserted on 1 December 2011, by clause 5 of the Electricity Industry Participation Code (Spot Price Risk Disclosure) Amendment 2011.

Clause 13.236H(1), (5), (7), (8), (9) and (10): amended, on 5 October 2017, by clause 473(2) of the Electricity Industry Participation Code Amendment (Code Review Programme) 2017.

13.236I Payment of auditor's costs

- (1) If an **audit** establishes, to the **Authority's** reasonable satisfaction, that a **disclosing participant's spot price risk disclosure statement** or the information set out in the certification given under clause 13.236F (as the case may be) has not complied with this subpart (whether or not the **Authority** appoints an investigator to investigate the alleged breach), the **disclosing participant** must pay the **auditor's** costs.
- (2) If the **Authority** considers that the **disclosing participant's** non-compliance is minor, the **Authority** may, in its discretion, determine the proportion of the **auditor's** costs that the **disclosing participant** must pay, and the **disclosing participant** must pay those costs.
- (3) If an **audit** establishes to the **Authority's** reasonable satisfaction that a **disclosing participant's spot price risk disclosure statement** or the information set out in the certification given under clause 13.236F (as the case may be) has complied with this subpart, the **Authority** must pay the **auditor's** costs.

Clause 13.236I: inserted on 1 December 2011, by clause 5 of the Electricity Industry Participation Code (Spot Price Risk Disclosure) Amendment 2011.

Clause 13.236I(1) and (3): amended, on 5 October 2017, by clause 474 of the Electricity Industry Participation Code Amendment (Code Review Programme) 2017.

Clause 13.236I(3): amended, on 21 September 2012, by clause 31 of the Electricity Industry Participation (Minor Amendments) Code Amendment 2012.

Subpart 5B—Hedge market arrangements

Heading: inserted on 3 February 2020, by clause 5 of the Electricity Industry Participation Code Amendment (Hedge Market Arrangements) 2020.

Heading: revoked on 3 November 2020, in accordance with section 40(2)(b) of the Electricity Industry Act 2010.

Heading: replaced on 27 April 2021, by clause 5 of the Electricity Industry Participation Code Amendment (Hedge Market Arrangements) 2021.

13.236J Contents of this subpart

This subpart provides for an active market for trading financial hedge contracts for **electricity** by specifying requirements for certain **participants**.

Clause 13.236J: inserted on 3 February 2020, by clause 5 of the Electricity Industry Participation Code Amendment (Hedge Market Arrangements) 2020.

Clause 13.236J: revoked on 3 November 2020, in accordance with section 40(2)(b) of the Electricity Industry Act 2010.

Clause 13.236J: replaced on 27 April 2021, by clause 6 of the Electricity Industry Participation Code Amendment (Hedge Market Arrangements) 2021.

13.236K Application of subpart

- (1) Subject to subclause (2), this subpart applies to the following **participants**:
 - (a) Contact Energy Limited;
 - (b) Genesis Energy Limited;
 - (c) Mercury NZ Limited;
 - (d) Meridian Energy Limited.
- (2) This subpart applies to a **participant** specified in subclause (1) if that **participant**—
 - (a) is not a party to a **NZEF market-making agreement** that includes the requirements set out in clause 13.236L; or
 - (b) does not perform market-making services in accordance with the **NZEF market-making agreement** on three or more separate occasions in a period of 90 days, and that non-performance is not permitted by an exemption or otherwise under the **NZEF market-making agreement**.
- (3) A **participant** to whom subclause (2) applies is relieved of its obligations under this subpart when the **Authority**—
 - (a) is satisfied that the **participant** has complied with its obligations under this subpart for a period of 90 days; and
 - (b) has given written notice to that effect to the **participant**, which the **Authority** must do within **5 business days** of being satisfied as to compliance.

Clause 13.236K: inserted on 3 February 2020, by clause 5 of the Electricity Industry Participation Code Amendment (Hedge Market Arrangements) 2020.

Clause 13.236K: revoked on 3 November 2020, in accordance with section 40(2)(b) of the Electricity Industry Act 2010.

Clause 13.236K: replaced on 27 April 2021, by clause 7 of the Electricity Industry Participation Code Amendment (Hedge Market Arrangements) 2021.

13.236L Requirement to quote

- (1) Subject to subclauses (2) to (5), the **participant** must, for a minimum of 25 minutes in every **NZEF market-making period**, provide **quotes** for a minimum of—
 - (a) 24 monthly **NZ electricity futures** for each of the Otahuhu reference **node** and the Benmore reference **node** (being 24 buy **quotes** and 24 sell **quotes** for each

- reference **node**) for the current month and each of the five months following the current month; and
- (b) 24 quarterly **NZ electricity futures** for each of the Otahuhu reference **node** and the Benmore reference **node** (being 24 buy **quotes** and 24 sell **quotes** for each reference **node**) for each calendar quarter that is available for trade on an **exchange**.
- (2) The **participant** must not provide a **quote** under subclause (1) with a **bid-ask spread** that exceeds the greater of 3% or NZ\$2. For the avoidance of doubt, where there are multiple buy **orders** and sell **orders** for a particular reference **node** for a particular month or calendar quarter in a **NZEF market-making period**, the requirement in this subclause means the **bid-ask spread** between the lowest priced buy **order** and the highest priced sell **order** (across those multiple **orders**) must not exceed the greater of 3% or NZ\$2.
- (3) Under subclause (1) for each **NZEF market-making period**, the **participant** must provide a quantity of initial **quotes** and (as applicable) **volume refresh** its **quotes** until it has traded the **total required volume** for each of the Otahuhu reference **node** and the Benmore reference **node** in relation to each particular month and calendar quarter as follows:
- (a) when first placing **orders** at or after the start of the **NZEF market-making period**, the **participant** is required to place a buy **order** of at least 12 **quotes** in total and a sell **order** of at least 12 **quotes** in total:
- (b) if either initial buy **order** or sell **order** is fully traded then that **participant** must (as applicable) **volume refresh** its **order(s)** such that where the amount of the **total traded NZEF** up to that point in time in the **NZEF market-making period** is—
- (i) 12, then at the end of the **volume refresh period** the buy **order** must comprise at least 12 **quotes** and the sell **order** must comprise at least 12 **quotes**;
- (ii) greater than 12, then at the end of the **volume refresh period** that **participant** must ensure that the number of **quotes** comprising each of the buy **order** and sell **order** respectively are a minimum of X , where—

$$X = 24 \text{ quotes} - \text{total traded NZEF}$$

- (c) once the **participant** has traded the **total required volume** it may withdraw any remaining **quotes**.
- (4) A **participant** required to **volume refresh** in accordance with clause 13.236L(3)(b) may also carry out any other changes not inconsistent with their obligations under this subpart that the **participant** chooses to make to any other **order(s)** for the particular month or calendar quarter and particular reference **node** that is the subject of the **volume refresh**.
- (5) For the purpose of determining whether a **participant** has met the minimum time requirement of 25 minutes under clause 13.236L(1), a **quote** will not be treated as being provided during a **volume refresh period**.

Clause 13.236L: inserted on 3 February 2020, by clause 5 of the Electricity Industry Participation Code Amendment (Hedge Market Arrangements) 2020.

Clause 13.236L: revoked on 3 November 2020, in accordance with section 40(2)(b) of the Electricity Industry Act 2010.

Clause 13.236L: replaced on 27 April 2021, by clause 8 of the Electricity Industry Participation Code Amendment (Hedge Market Arrangements) 2021.

Clause 13.236L: replaced on 1 September 2022, by clause 5 of the Electricity Industry Participation Code Amendment (Hedge Market Arrangements) 2022.

13.236M *[Revoked]*

Clause 13.236M: inserted on 3 February 2020, by clause 5 of the Electricity Industry Participation Code Amendment (Hedge Market Arrangements) 2020.

Clause 13.236M: revoked on 3 November 2020, in accordance with section 40(2)(b) of the Electricity Industry Act 2010.

13.236N Exemptions from requirement to quote

- (1) The **participant** is exempt from the requirements in clause 13.236L in the following circumstances:
 - (a) for a **NZEF market-making period** if—
 - (i) the **participant** cannot comply with a requirement in clause 13.236L in that **NZEF market-making period** because an **exchange** trading platform is disrupted or unavailable; or
 - (ii) in the reasonable opinion of the **participant**, entering into a contract for a **NZ electricity future** in that **NZEF market-making period** may cause the **participant** to breach an applicable law;
 - (b) in addition to the exemptions in paragraph (a), for up to two **NZEF market-making periods** within any 20 consecutive **NZEF market-making periods** at the **participant's** discretion.
- (2) To avoid doubt, if the **participant** meets the criteria for exemption in subclause (1)(a)(i) or (1)(a)(ii) in relation to a **NZEF market-making period**, that **NZEF market-making period** will not count towards the **participant's** two exemptions in subclause (1)(b).
- (3) If the **participant** relies on an exemption under this clause 13.236N from the requirement to **quote**, the **participant** must notify the **Authority** of the exemption it has relied on and the basis for the exemption as soon as practicable but in any case no later than 1700 New Zealand time on the same **business day** that an exemption is relied on.

Clause 13.236N: inserted on 3 February 2020, by clause 5 of the Electricity Industry Participation Code Amendment (Hedge Market Arrangements) 2020.

Clause 13.236N: revoked on 3 November 2020, in accordance with section 40(2)(b) of the Electricity Industry Act 2010.

Clause 13.236N: replaced on 27 April 2021, by clause 9 of the Electricity Industry Participation Code Amendment (Hedge Market Arrangements) 2021.

Clause 13.236N(1)(b): amended on 1 September 2022, by clause 6(1) of the Electricity Industry Participation Code Amendment (Hedge Market Arrangements) 2022.

Clause 13.236N(3): amended on 1 September 2022, by clause 6(2)(a) and (b) of the Electricity Industry Participation Code Amendment (Hedge Market Arrangements) 2022.

Subpart 6—Financial transmission rights

Heading: inserted, on 1 October 2011, by clause 8 of the Electricity Industry Participation (Financial Transmission Rights) Code Amendment 2011.

13.237 Contents of this subpart

This subpart provides for the processes by which—

- (a) the **FTR manager** prepares and **publishes** the **FTR allocation plan**; and
- (b) the **Authority** approves the **FTR allocation plan**; and
- (c) the **FTR manager** allocates and creates **FTRs**; and

- (d) the **FTR manager** operates the **FTR register** and collects information from the **grid owner** and **clearing manager**; and
- (e) **FTRs** may be assigned; and
- (f) the **clearing manager** collects and allocates **FTR auction** revenue and collects information from the **FTR manager**; and
- (g) the **Authority** may direct the **FTR manager** to suspend the allocation of **FTRs**.

Clause 13.237: inserted, on 1 October 2011, by clause 8 of the Electricity Industry Participation (Financial Transmission Rights) Code Amendment 2011.

Clause 13.237(c): amended, on 1 November 2014, by clause 5 of the Electricity Industry Participation (FTR Reconfiguration Auctions) Code Amendment 2014.

FTR allocation plan

Heading: inserted, on 1 October 2011, by clause 8 of the Electricity Industry Participation (Financial Transmission Rights) Code Amendment 2011.

13.238 Preparation and publication of FTR allocation plan

- (1) The **FTR manager** must prepare and **publish** an **FTR allocation plan** that complies with Schedule 13.5.
- (2) The **FTR manager** must keep the **FTR allocation plan published** at all times.
- (3) Subject to subclause (4), if Schedule 13.5 is amended, the **FTR manager** must, no later than 3 months after the date on which the amendment comes into force, submit to the **Authority** for approval under clause 13.241(4), a variation to the **FTR allocation plan** to make the **FTR allocation plan** consistent with Schedule 13.5.
- (4) The **FTR manager** is not required to comply with subclause (3) if no amendment is necessary to make the **FTR allocation plan** consistent with Schedule 13.5.

Clause 13.238: inserted, on 1 October 2011, by clause 8 of the Electricity Industry Participation (Financial Transmission Rights) Code Amendment 2011.

Clause 13.238(2): replaced, on 5 October 2017, by clause 475 of the Electricity Industry Participation Code Amendment (Code Review Programme) 2017.

13.239 FTR manager gives draft FTR allocation plan to Authority

- (1) The **FTR manager** must submit to the **Authority** for approval a draft **FTR allocation plan** by the date specified in the **market operation service provider agreement** between the **FTR manager** and the **Authority**.
- (2) In preparing the draft **FTR allocation plan**, the **FTR manager** must—
 - (a) consult with persons that the **FTR manager** thinks are representative of the interests of persons likely to be substantially affected by the plan; and
 - (b) consider submissions made on the plan.
- (3) The **FTR manager** must provide a copy of each submission received under subclause (2) to the **Authority**.

Clause 13.239: inserted, on 1 October 2011, by clause 8 of the Electricity Industry Participation (Financial Transmission Rights) Code Amendment 2011.

13.240 Authority approves FTR allocation plan

- (1) The **Authority** must, as soon as practicable after receiving the draft **FTR allocation plan**, by notice in writing to the **FTR manager**—
 - (a) approve the plan; or

- (b) decline to approve the plan.
- (2) If the **Authority** declines to approve the draft **FTR allocation plan**, the **Authority** must **publish** the changes that the **Authority** wishes the **FTR manager** to make to the draft plan.
- (3) When the **Authority publishes** the changes that the **Authority** wishes the **FTR manager** to make to the draft **FTR allocation plan** under subclause (2), the **Authority** must give written notice to the **FTR manager** and interested parties of the date by which submissions on the changes must be received by the **Authority**.
- (4) Each submission on the changes to the draft **FTR allocation plan** must be made in writing to the **Authority** and be received on or before the date specified by the **Authority** under subclause (3).
- (5) The **Authority** must—
- (a) provide a copy of each submission received to the **FTR manager**; and
- (b) **publish** the submissions.
- (6) The **FTR manager** may make its own submission on the changes to the draft **FTR allocation plan** and the submissions received in relation to the changes. The **Authority** must **publish** the **FTR manager's** submission when it is received.
- (7) The **Authority** must consider the submissions made to it on the changes to the draft **FTR allocation plan**.
- (8) Following the consultation required by subclauses (3) to (7), the **Authority** may approve the **FTR allocation plan** subject to the changes that the **Authority** considers appropriate being made by the **FTR manager**.

Clause 13.240: inserted, on 1 October 2011, by clause 8 of the Electricity Industry Participation (Financial Transmission Rights) Code Amendment 2011.

Clause 13.240(3): amended, on 5 October 2017, by clause 476 of the Electricity Industry Participation Code Amendment (Code Review Programme) 2017.

13.241 Variations to FTR allocation plan

- (1) A **participant** or the **Authority** may submit a proposal for a variation to the **FTR allocation plan** to the **FTR manager**.
- (2) The **FTR manager** must provide a copy of each proposed variation received from a **participant** under subclause (1) to the **Authority**.
- (3) The **FTR manager** must consider a proposed variation to the **FTR allocation plan** submitted under subclause (1).
- (4) The **FTR manager** may submit a request for a variation to the **FTR allocation plan** to the **Authority**.
- (5) The consultation and approval requirements under clause 13.239(2) and (3) and clause 13.240 apply to a request for a variation submitted under subclause (4) as if references to the draft plan were a reference to the requested variation.
- (6) If the **FTR manager** does not submit a request for a variation submitted under subclause (1) to the **Authority** under subclause (4), the **Authority** may consider the proposal and require the **FTR manager** to submit a request for a variation based on the proposal to the **Authority**, and subclause (5) applies accordingly.
- (7) The **Authority** may approve a variation requested under subclause (4) or subclause (6) without complying with the provisions referred to in subclause (5) if—

- (a) the **Authority** considers that it is necessary or desirable in the public interest that the requested variation be made urgently; and
 - (b) the **Authority publishes** a notice of the variation and a statement of the reasons why the urgent variation is needed.
- (8) Every variation made under subclause (7) expires on the date that is 9 months after the date on which the variation is made.

Clause 13.241: inserted, on 1 October 2011, by clause 8 of the Electricity Industry Participation (Financial Transmission Rights) Code Amendment 2011.

Allocation, creation and reconfiguration of FTRs

Heading: inserted, on 1 October 2011, by clause 8 of the Electricity Industry Participation (Financial Transmission Rights) Code Amendment 2011.

Heading: amended, on 1 November 2014, by clause 6 of the Electricity Industry Participation (FTR Reconfiguration Auctions) Code Amendment 2014.

13.242 FTR manager must allocate and create FTRs

- (1) The **FTR manager** must conduct an **FTR auction** in accordance with the **FTR allocation plan** approved under clause 13.240 to—
- (a) allocate **FTRs**; and
 - (b) create **FTRs**; and
 - (c) reconfigure **FTRs**.
- (2) Every **FTR** must relate to—
- (a) a minimum amount of **electricity** (in **MW**) of 0.1 **MW**; and
 - (b) an amount of **electricity** (in **MW**) that is a multiple of 0.1**MW**.

Clause 13.242: inserted, on 1 October 2011, by clause 8 of the Electricity Industry Participation (Financial Transmission Rights) Code Amendment 2011.

Clause 13.242(2): substituted, on 1 June 2012, by clause 4 of the Electricity Industry Participation (Removal of Quantity Limit for Financial Transmission Rights) Code Amendment 2012.

Clause 13.242 heading: amended, on 1 November 2014, by clause 7(a) of the Electricity Industry Participation (FTR Reconfiguration Auctions) Code Amendment 2014.

Clause 13.242(1): amended, on 1 November 2014, by clause 7(b) of the Electricity Industry Participation (FTR Reconfiguration Auctions) Code Amendment 2014.

13.242A FTR manager to adjust offered FTR and FTR acquisition cost after FTR reconfiguration auction

After each **FTR reconfiguration auction**, the **FTR manager** must—

- (a) reduce the amount of **electricity** (in **MW**) to which each **offered FTR** relates by the amount of **electricity** (in **MW**) to which the relevant **reconfigured FTR** relates; and
- (b) adjust the **FTR acquisition cost** of the **offered FTR** by subtracting the **FTR reconfiguration amount** of the relevant **reconfigured FTR** from the **FTR acquisition cost** of the **offered FTR**.

Clause 13.242A: inserted, on 1 November 2014, by clause 8 of the Electricity Industry Participation (FTR Reconfiguration Auctions) Code Amendment 2014.

13.243 Participation in FTR auction

The **FTR manager** must not allow a person to participate in an **FTR auction** unless the **FTR manager** is satisfied that the person complies with prudential requirements in Part 14A.

Clause 13.243: inserted, on 1 October 2011, by clause 8 of the Electricity Industry Participation (Financial Transmission Rights) Code Amendment 2011.

Clause 13.243: amended, on 24 March 2015, by clause 14 of the Electricity Industry Participation (Settlement and Prudential Security) Code Amendment 2013.

13.244 Acceptance of bids and offers in FTR auction

- (1) The **FTR manager** must not accept a bid or an offer in an **FTR auction** if the **FTR manager** considers that the bid or the offer, if accepted, would cause the person making the bid or the offer to incur an obligation for which it does not have sufficient acceptable security under Part 14A.
- (2) For the purposes of subclause (1), the **FTR manager** must, based on information received from the **clearing manager**, determine the maximum liability that each person can incur in respect of its bids or offers in the **FTR auction**.

Clause 13.244: inserted, on 1 October 2011, by clause 8 of the Electricity Industry Participation (Financial Transmission Rights) Code Amendment 2011.

Clause 13.244 heading: amended, on 1 November 2014, by clause 9(a) of the Electricity Industry Participation (FTR Reconfiguration Auctions) Code Amendment 2014.

Clause 13.244(1): amended, on 1 November 2014, by clause 9(b) and (c) of the Electricity Industry Participation (FTR Reconfiguration Auctions) Code Amendment 2014.

Clause 13.244(1): amended, on 24 March 2015, by clause 15 of the Electricity Industry Participation (Settlement and Prudential Security) Code Amendment 2013.

Clause 13.244(2): amended, on 1 November 2014, by clause 9(d) of the Electricity Industry Participation (FTR Reconfiguration Auctions) Code Amendment 2014.

Auction revenue and FTR receipts and payments

Heading: inserted, on 1 October 2011, by clause 8 of the Electricity Industry Participation (Financial Transmission Rights) Code Amendment 2011.

13.245 Clearing manager must collect and allocate auction revenue

The **clearing manager** must collect the **FTR auction** revenue and allocate it in accordance with Part 14.

Clause 13.245: inserted, on 1 October 2011, by clause 8 of the Electricity Industry Participation (Financial Transmission Rights) Code Amendment 2011.

13.246 Clearing manager must deal with FTR receipts and payments

The **clearing manager** must deal with all receipts and payments in respect of **FTRs** in accordance with Part 14.

Clause 13.246: inserted, on 1 October 2011, by clause 8 of the Electricity Industry Participation (Financial Transmission Rights) Code Amendment 2011.

FTR register

Heading: inserted, on 1 October 2011, by clause 8 of the Electricity Industry Participation (Financial Transmission Rights) Code Amendment 2011.

13.247 FTR manager must operate FTR register

- (1) The **FTR manager** must create and operate an **FTR register** that records—
 - (a) the holdings of **FTRs**; and
 - (b) the **FTR acquisition cost** for each **FTR**; and
 - (c) assignments of **FTRs** including any price disclosed under clause 13.249; and
 - (d) the amount of **electricity** (in **MW**) to which each **FTR** relates; and
 - (e) the reconfiguration of each **offered FTR**.
- (2) The **FTR register** must contain an account for each holder of an **FTR**.
- (3) The **FTR manager** must assign a registered number to each **FTR** recorded in the **FTR register**.
- (4) The **FTR manager** must maintain, **publish**, and keep **published** at all times, an up to date copy of the **FTR register**.

Clause 13.247: inserted, on 1 October 2011, by clause 8 of the Electricity Industry Participation (Financial Transmission Rights) Code Amendment 2011.

Clause 13.247(1)(d): inserted, on 1 June 2012, by clause 5 of the Electricity Industry Participation (Removal of Quantity Limit for Financial Transmission Rights) Code Amendment 2012.

Clause 13.247(1)(b): amended, on 1 November 2012, by clause 5 of the Electricity Industry Participation (Financial Transmission Rights) Code Amendment 2012.

Clause 13.247(1)(e): inserted, on 1 November 2014, by clause 10 of the Electricity Industry Participation (FTR Reconfiguration Auctions) Code Amendment 2014.

Clause 13.247(4): replaced, on 5 October 2017, by clause 477 of the Electricity Industry Participation Code Amendment (Code Review Programme) 2017.

Assignment of FTRs

Heading: inserted, on 1 October 2011, by clause 8 of the Electricity Industry Participation (Financial Transmission Rights) Code Amendment 2011.

13.248 Assignment of FTRs

- (1) If a person ("assignor") wishes to assign an **FTR** or part of an **FTR** to another person ("assignee"), the assignor and assignee must complete and sign Form 1 in Schedule 13.6 and provide it to the **FTR manager**.
- (2) The completed form may be provided to the **FTR manager** under subclause (1) in electronic form if—
 - (a) both the assignor and assignee consent to completing and signing the form electronically; and
 - (b) the electronic form contains all of the information required by Form 1 in Schedule 13.6; and
 - (c) the notification of assignment to the **FTR manager** is in a format specified by the **FTR manager**.
- (3) The **FTR manager** must not register an assignment in the **FTR register** unless the **FTR manager** is satisfied that the assignee complies with prudential requirements in Part 14A.
- (4) The **FTR manager**, on being satisfied that all requirements for an assignment are met, must register the assignment on the **FTR register**.

- (4A) If an assignment is made under this clause in respect of part of an **FTR**, the **FTR manager** must register the assignment as follows:
- (a) create a new record for an **FTR** in respect of the amount of **electricity** (in **MW**) to which the assignment relates; and
 - (b) amend the record for the **FTR** retained by the assignor by reducing the amount of **electricity** (in **MW**) to which the **FTR** relates so as to reflect the assignment.
- (5) An assignment of an **FTR** or part of an **FTR** is not effective unless it is registered on the **FTR register** by the **FTR manager**.
- (6) The **FTR manager** must not register an assignment that is expressed to have effect after the end of the **billing period** to which the **FTR** relates.
- Clause 13.248: inserted, on 1 October 2011, by clause 8 of the Electricity Industry Participation (Financial Transmission Rights) Code Amendment 2011.
- Clause 13.248(1): amended, on 1 June 2012, by clause 6(1) of the Electricity Industry Participation (Removal of Quantity Limit for Financial Transmission Rights) Code Amendment 2012.
- Clause 13.248(2): amended, on 5 October 2017, by clause 478 of the Electricity Industry Participation Code Amendment (Code Review Programme) 2017.
- Clause 13.248(3): amended, on 24 March 2015, by clause 16 of the Electricity Industry Participation (Settlement and Prudential Security) Code Amendment 2013.
- Clause 13.248(4A): inserted, on 1 June 2012, by clause 6(2) of the Electricity Industry Participation (Removal of Quantity Limit for Financial Transmission Rights) Code Amendment 2012.
- Clause 13.248(5): amended, on 1 June 2012, by clause 6(3) of the Electricity Industry Participation (Removal of Quantity Limit for Financial Transmission Rights) Code Amendment 2012.

13.249 Liability for FTR acquisition cost when FTR assigned and price disclosed

- (1) This clause applies if—
- (a) an **FTR** is assigned under clause 13.248; and
 - (b) the notification of assignment discloses the price (being an amount that may be positive or negative) at which the **FTR** has been assigned.
- (2) The **FTR manager** must provide a copy of the notification of assignment to the **clearing manager**.
- (3) The assignee owes the **clearing manager** the amount disclosed under subclause (1)(b) when it becomes due on settlement of the **FTR**.
- (4) If the price disclosed in the notification is less than the **FTR acquisition cost** in respect of the **FTR** that would, if the assignment had not taken place, become owing on settlement of the **FTR**, the assignor owes the **clearing manager** an amount equal to the difference between the **FTR acquisition cost** and the price at which the **FTR** has been assigned.
- (5) The **clearing manager** must advise the assignor of the amount owing under subclause (4) when the **clearing manager** advises amounts owing under subpart 4 of Part 14 for the **billing period** in which the assignment took place.
- (6) The **clearing manager** must apply any amount owing by a **participant** to the **clearing manager** under this clause to the settlement of **FTRs**, but an amount must not be applied to the settlement of an **FTR** until the **billing period** in which the **FTR** is settled.
- (7) If the price disclosed in the notification is more than the **FTR acquisition cost** in respect of the **FTR** that would, if the assignment had not taken place, become owing on settlement of the **FTR**, the **clearing manager** owes the assignor on settlement of the **FTR** an amount equal to the difference between the price at which the **FTR** has been assigned and the **FTR acquisition cost**.

Clause 13.249: inserted, on 1 October 2011, by clause 8 of the Electricity Industry Participation (Financial Transmission Rights) Code Amendment 2011.

Clause 13.249 Heading: amended, on 1 November 2012, by clause 6(1) of the Electricity Industry Participation (Financial Transmission Rights) Code Amendment 2012.

Clause 13.249(1)(b): amended, on 1 November 2012, by clause 6(2) of the Electricity Industry Participation (Financial Transmission Rights) Code Amendment 2012.

Clause 13.249(3): amended, on 24 March 2015, by clause 17(a) of the Electricity Industry Participation (Settlement and Prudential Security) Code Amendment 2013.

Clause 13.249(4): amended, on 1 November 2012, by clause 6(3) of the Electricity Industry Participation (Financial Transmission Rights) Code Amendment 2012.

Clause 13.249(4): amended, on 24 March 2015, by clause 17(b) of the Electricity Industry Participation (Settlement and Prudential Security) Code Amendment 2013.

Clause 13.249(5): amended, on 24 March 2015, by clause 17(c) of the Electricity Industry Participation (Settlement and Prudential Security) Code Amendment 2013.

Clause 13.249(6): substituted, on 24 March 2015, by clause 17(d) of the Electricity Industry Participation (Settlement and Prudential Security) Code Amendment 2013.

Clause 13.249(7): amended, on 1 November 2012, by clause 6(4) of the Electricity Industry Participation (Financial Transmission Rights) Code Amendment 2012.

Clause 13.249(7): amended, on 24 March 2015, by clause 17(e) of the Electricity Industry Participation (Settlement and Prudential Security) Code Amendment 2013.

13.250 Liability for FTR acquisition cost when FTR assigned and price not disclosed

- (1) This clause applies if—
 - (a) an **FTR** is assigned under clause 13.248; and
 - (b) the notification of assignment does not disclose the price at which the **FTR** has been assigned.
- (2) The **FTR manager** must provide a copy of the notification of assignment to the **clearing manager**.
- (3) The assignee owes the **clearing manager** the **FTR acquisition cost** in respect of the **FTR** that has been assigned when it becomes due on settlement of the **FTR**.

Clause 13.250: inserted, on 1 October 2011, by clause 8 of the Electricity Industry Participation (Financial Transmission Rights) Code Amendment 2011.

Clause 13.250 Heading: amended, on 1 November 2012, by clause 7(1) of the Electricity Industry Participation (Financial Transmission Rights) Code Amendment 2012.

Clause 13.250(3): amended, on 1 November 2012, by clause 7(2) of the Electricity Industry Participation (Financial Transmission Rights) Code Amendment 2012.

Clause 13.250(3): amended, on 24 March 2015, by clause 18 of the Electricity Industry Participation (Settlement and Prudential Security) Code Amendment 2013.

Provision of information to the FTR manager and clearing manager

Heading: inserted, on 1 October 2011, by clause 8 of the Electricity Industry Participation (Financial Transmission Rights) Code Amendment 2011.

13.251 Information to be provided to FTR manager

- (1) Each **grid owner** must provide a written forecast of the configuration and capacity of the **grid owner's grid** for the **FTR period** (as advised to each **grid owner** by the **FTR manager**) to the **FTR manager** for use in determining the **FTRs** to be offered in each **FTR auction**.
- (2) The information that each **grid owner** must provide must include relevant planned outages.
- (3) Except as otherwise agreed with the **FTR manager**, each **grid owner** must provide the information to the **FTR manager** no later than 1 month before the date (as advised to each **grid owner** by the **FTR manager**) on which an **FTR auction** is to be held.
- (4) The **clearing manager** must advise the **FTR manager** in writing—

- (a) whether a person who has applied to participate in an **FTR auction** complies with prudential requirements in Part 14A; and
 - (b) the amount of security that a person who has applied to participate in an **FTR auction** has provided that exceeds that person's other obligations under Parts 14 and 14A.
- (5) Except as otherwise agreed with the **FTR manager**, the **clearing manager** must provide the information to the **FTR manager** no later than 2 **business days** before the date (as advised to the **clearing manager** by the **FTR manager**) on which an **FTR auction** is to be held.
- (6) If the information referred to in subclause (4) changes, the **clearing manager** must, if requested by the person who has applied to participate in an **FTR auction**, provide the updated information in writing to the **FTR manager**.
- (7) The **clearing manager** must inform the **FTR manager** in writing, as soon as practicable after receiving a request from the **FTR manager**, whether an assignee of an **FTR** meets the prudential security requirements in Part 14A.

Clause 13.251: inserted, on 1 October 2011, by clause 8 of the Electricity Industry Participation (Financial Transmission Rights) Code Amendment 2011.

Clause 13.251(1), (4), (6) and (7): amended, on 5 October 2017, by clause 479 of the Electricity Industry Participation Code Amendment (Code Review Programme) 2017.

Clause 13.251(4): amended, on 24 March 2015, by clause 19(a) of the Electricity Industry Participation (Settlement and Prudential Security) Code Amendment 2013.

Clause 13.251(7): amended, on 24 March 2015, by clause 19(b) of the Electricity Industry Participation (Settlement and Prudential Security) Code Amendment 2013.

13.252 Information to be provided to clearing manager

- (1) The **FTR manager** must provide the following information to the **clearing manager** in writing in relation to each successful bidder in an **FTR auction**:
- (a) the details of each **FTR** allocated under an **FTR auction**, including—
 - (i) the period to which the **FTR** applies; and
 - (ii) whether the **FTR** is an **option FTR** or an **obligation FTR**; and
 - (iii) the formula under which the **FTR hedge value** is to be calculated for the settlement of the **FTR**;
 - (b) the **FTR acquisition cost** in respect of each **FTR**.
- (2) The **FTR manager** must provide the information specified in subclause (1) to the **clearing manager** as soon as practicable and no later than 1 week after each **FTR auction**.

Clause 13.252: inserted, on 1 October 2011, by clause 8 of the Electricity Industry Participation (Financial Transmission Rights) Code Amendment 2011.

Clause 13.252(1): amended, on 1 November 2012, by clause 8 of the Electricity Industry Participation (Financial Transmission Rights) Code Amendment 2012.

Clause 13.252(1): amended, on 5 October 2017, by clause 480 of the Electricity Industry Participation Code Amendment (Code Review Programme) 2017.

13.253 *[Revoked]*

Clause 13.253: inserted, on 1 October 2011, by clause 8 of the Electricity Industry Participation (Financial Transmission Rights) Code Amendment 2011.

Clause 13.253: revoked, on 5 October 2017, by clause 481 of the Electricity Industry Participation Code Amendment (Code Review Programme) 2017.

13.254 Publication of results of FTR auctions

The **FTR manager** must, as soon as practicable after each **FTR auction**, **publish** and **keep published** the results of each **FTR auction** in accordance with the **FTR allocation plan**.

Clause 13.254: inserted, on 1 October 2011, by clause 8 of the Electricity Industry Participation (Financial Transmission Rights) Code Amendment 2011.

Clause 13.254: amended, on 5 October 2017, by clause 482 of the Electricity Industry Participation Code Amendment (Code Review Programme) 2017.

Suspension of FTR allocation

Heading: inserted, on 1 October 2011, by clause 8 of the Electricity Industry Participation (Financial Transmission Rights) Code Amendment 2011.

13.255 Authority may direct FTR manager to suspend allocation of FTRs

The **Authority** may direct the **FTR manager** to suspend the allocation of **FTRs** if there is any situation that—

- (a) threatens, or may threaten, confidence in, or the integrity of, the allocation or settlement of **FTRs**; and
- (b) in the reasonable opinion of the **Authority**, cannot satisfactorily be resolved by any other mechanism available under this Code.

Clause 13.255: inserted, on 1 October 2011, by clause 8 of the Electricity Industry Participation (Financial Transmission Rights) Code Amendment 2011.

Clause 13.255: amended, on 18 July 2013, by clause 9(1) of the Electricity Industry Participation (Undesirable Trading Situation) Code Amendment 2013.

Clause 13.255(a): substituted, on 18 July 2013, by clause 9(2) of the Electricity Industry Participation (Undesirable Trading Situation) Code Amendment 2013.

Clause 13.255(b): amended, on 18 July 2013, by clause 9(3) of the Electricity Industry Participation (Undesirable Trading Situation) Code Amendment 2013.

Provision of internal transfer pricing information by generator retailers

Heading: inserted, on 30 November 2021, by clause 5 of the Electricity Industry Participation Code Amendment (Internal Transfer Prices and Segmented Profitability Reporting) 2021.

13.256 Generator retailers must provide ITP information to the Authority

- (1) Each **generator retailer** must provide the **ITP information** in relation to the **generator retailer** to the **Authority** in the form and by the means specified by the **Authority** no later than 90 days after the end of the **financial year** of the **generator retailer**.
- (2) The **ITP information** must consist of the following information in relation to the **generator retailer's financial year**:
 - (a) the average load weighted **retail ITP**, calculated by dividing the total notional cost of **electricity** under the **retail ITP** arrangements of the **generator retailer** by the total amount of **electricity** in **MWh** sold by the **generator retailer** to **mass market customers**;
 - (b) information on how the **generator retailer** determined the **retail ITP**, at a sufficient level of detail to enable a reasonable person, being a person who has a reasonably sophisticated understanding of the operation of the **electricity** industry and the **wholesale market**, to determine how the **generator retailer** determined the **retail ITP**.
- (3) The information provided by a **generator retailer** under subclause (2)(b) must include the following:

- (a) a breakdown of the key components or factors which make up the **retail ITP** expressed as an amount in dollars and cents per **MWh** that each key component or factor comprises of the average load weighted **retail ITP** required by subclause (2)(a), and which must include (if relevant) the following components or factors:
- (i) prices in **ASX NZ electricity futures**:
 - (ii) the distribution of the total electrical load across locations, including the adjustment, calculated on an average load weighted basis in **MWh**, that the **retailer** generator used to determine the **retail ITP** for the **electricity** sold to **mass market customers** beyond a **node** specified in an **ASX NZ electricity future**:
 - (iii) administrative fees, including management fees, notionally charged by the **generator retailer** to the **generator retailer's** retail arm:
 - (iv) the level of discretionary judgement the **generator retailer** exercised to amend or otherwise modify the draft **retail ITP** before it was finalised:
 - (v) all other key components or factors the **generator retailer** relied on to determine the **retail ITP**, and any other material information used by the **generator retailer** to determine the **retail ITP** that is not publicly available:
- (b) any residual components or factors that make up the **retail ITP**, but which are not components or factors required by paragraph (a), expressed as one combined amount in dollars and cents per **MWh**:
- (c) an explanation of the methodology the **generator retailer** used to determine or to assist in determining the **retail ITP**, and which must include (if relevant) the following:
- (i) the assumed process used by the **generator retailer** to build the hedge book of **ASX NZ electricity futures**, including the following:
 - (A) the proportion of **ASX NZ electricity futures** the **generator retailer** assumed would be purchased and the assumed timing of those assumed purchases:
 - (B) the relative weighting of **ASX NZ electricity futures** relating to Benmore as compared to those relating to Otahuhu:
 - (C) the types of **ASX NZ electricity futures** the **generator retailer** assumed to be purchased and the maturities purchased:
 - (D) the basis on which the **ASX NZ electricity futures** are priced:
 - (ii) the approach the **generator retailer** took to adjust for:
 - (A) differences in the within day electrical load and cost profile underlying the **ASX NZ electricity futures** and the **generator retailer's mass market customers** load profile:
 - (B) distribution of electrical load across locations, including the relative use of **FTRs** or historical price differences to price for load by location:
 - (iii) the approach or methodology used to determine the electrical load profile, including the following:
 - (A) whether actual or assumed load profiles are relied upon:
 - (B) the degree of granularity of load with respect to location, seasonality and intra-day:

- (C) the percentage of load by regional geographical location:
 - (iv) the basis for and determination of fees, including management or associated fees, the **generator retailer** notionally charged its retail arm:
 - (v) the basis for and rationale behind any discretion the **generator retailer** exercised:
 - (vi) any other details the **generator retailer** considers material to explain the methodology the **generator retailer** used to determine or assist in determining the **retail ITP**:
 - (d) the key non-price parameters the **generator retailer** used to determine the **retail ITP** including whether or not the **retail ITP** is:
 - (i) for fixed or variable volume of **electricity**; or
 - (ii) for a fixed or variable price of **electricity**:
 - (e) the purposes for which the **retail ITP** is used by the **generator retailer**, including whether the **retail ITP** is used as part of setting the price of **electricity** sold to **mass market customers** by the **generator retailer**:
 - (f) if relevant, and if not disclosed under paragraph (e), any matters relating to the **generator retailer** which the **retail ITP** directly or indirectly affects.
- (4) Where a **generator retailer** and one or more other **generator retailers** are related companies, as defined in section 2 of the Companies Act 1993, and are required by subclause (1) to provide **ITP information** to the **Authority**, the obligation in subclause (1) is met by one of those **generator retailers** providing the **ITP information** relating to all the **generator retailers** on a consolidated basis for the **generator retailers** to the **Authority**.
- (5) If a **generator retailer** provides **ITP information** on behalf of other **generator retailers** under subclause (4), the **generator retailer** providing the **ITP information** must identify the other **generator retailers** as part of the **ITP information** provided.
- Clause 13.256: inserted, on 30 November 2021, by clause 5 of the Electricity Industry Participation Code Amendment (Internal Transfer Prices and Segmented Profitability Reporting) 2021.

13.257 Disclosure of change of methodology

- (1) This clause applies if—
- (a) a **generator retailer** changes the methodology used to determine the **retail ITP** for a **financial year** (“the current **financial year**”) from the methodology used in a previous **financial year** for which the **generator retailer** provided **ITP information** under clause 13.256, other than where that change relates solely to the distribution of the customer load base or the input prices (**ASX NZ electricity futures** prices and locational prices as provided for in clause 13.256(3)(a)(i) and (ii)); and
 - (b) that change in methodology has the effect of modifying the **retail ITP** by an amount in excess of 5% from the **retail ITP** contained in the most recent **ITP information** the **generator retailer** provided under clause 13.256.
- (2) Where this clause applies, the **generator retailer** must also provide the following information to the **Authority** in the form and by the means specified by the **Authority**:
- (a) details of the impact on the average load weighted **retail ITP** disclosed under clause 13.256 for any of the previous three **financial years** if the new

methodology had been used to determine the **generator retailer's retail ITP** for those previous **financial years**:

- (b) details of the impact on the average load weighted **retail ITP** for the current **financial year** if the methodology used in any of those previous **financial years** was used to determine the **generator retailer's retail ITP** for the current **financial year**.
- (3) The **generator retailer** must provide the information required by subclause (2) to the **Authority** at the same time as providing the **ITP information** required under clause 13.256 for the current **financial year**.
- (4) Where a **generator retailer** and one or more other **generator retailers** are related companies, as defined in section 2 of the Companies Act 1993, and are required by subclause (2) to provide information to the **Authority**, the obligations in subclause (2) are met by one of those **generator retailers** providing the information relating to all the **generator retailers** on a consolidated basis for all the **generator retailers** to the **Authority**.
- (5) If a **participant** provides information on behalf of other **generator retailers** under subclause (4), the **generator retailer** providing the information must identify the other **generator retailers** as part of the information provided.

Clause 13.257: inserted, on 30 November 2021, by clause 5 of the Electricity Industry Participation Code Amendment (Internal Transfer Prices and Segmented Profitability Reporting) 2021.

13.258 Publication of ITP information by the Authority

The **Authority** may publish any **ITP information** or information submitted to it under clause 13.257, as the **Authority** sees fit.

Clause 13.258: inserted, on 30 November 2021, by clause 5 of the Electricity Industry Participation Code Amendment (Internal Transfer Prices and Segmented Profitability Reporting) 2021.

Provision of retail gross margin reports by retailers

Heading: inserted, on 30 November 2021, by clause 5 of the Electricity Industry Participation Code Amendment (Internal Transfer Prices and Segmented Profitability Reporting) 2021.

13.259 Provision of retail gross margin report by retailers

- (1) Each **retailer** must provide a **retail gross margin report** to the **Authority** no later than 90 days after the end of the **retailer's financial year**.
- (2) Subclause (1) does not apply to any **retailer** who was recorded in the **registry** in any of the preceding 12 months as being responsible for less than 1% of the total number of **ICPs** registered in the **registry** with an **ICP** status of "Active".
- (3) The **retail gross margin report** must consist of the following information relating to the sale of **electricity** to **mass market customers** for the **financial year** by the **retailer**:
 - (a) the total amount of **electricity** sold by the **retailer** to **mass market customers** expressed as **MWhs**;
 - (b) revenue derived from the sale of **electricity** to **mass market customers** expressed as an amount of dollars per **MWh**;
 - (c) cost of **electricity** sold by the **retailer** to **mass market customers**, including the cost of **electricity** derived from **retail ITP**, expressed as an amount of dollars per **MWh**;

- (d) cost of **metering** services associated with the sale of **electricity** to **mass market customers** expressed as an amount per **MWh**;
 - (e) cost of **distribution** services associated with the sale of **electricity** to **mass market customers** expressed as an amount per **MWh**;
 - (f) cost of transmission services, being those services provided by **Transpower** under a **transmission agreement**, paid by the **retailer** associated with the supply of **electricity** to **mass market customers** by the **retailer** expressed as an amount per **MWh**;
 - (g) cost of levies associated with the supply of **electricity** to **mass market customers** by the **retailer** expressed as an amount per **MWh**.
- (4) A **retail gross margin report** must be prepared in accordance with generally accepted accounting practices and in the form specified by the **Authority**.
- (5) Where a **retailer** and one or more other **retailers** are related companies, as defined in section 2 of the Companies Act 1993, and are required by subclause (1) to provide a **retail gross margin report** to the **Authority**—
- (a) the obligation in subclause (1) is met by one of those **retailers** providing the **retail gross margin report** relating to all the **retailers** on a consolidated basis for all the **retailers** to the **Authority**; and
 - (b) in any such case, the **retailer** providing the information must identify the other **retailers**, as part of the information provided.

Clause 13.259: inserted, on 30 November 2021, by clause 5 of the Electricity Industry Participation Code Amendment (Internal Transfer Prices and Segmented Profitability Reporting) 2021.

13.260 Publication of information contained in retail gross margin reports by the Authority

The **Authority** may **publish** the information received in a **retail gross margin report**, except that information contained in a **retail gross margin report** submitted by a **retailer** with less than 5% of total market share by **ICP** with a status of “Active” must be anonymised so as not to identify that **retailer**.

Clause 13.260: inserted, on 30 November 2021, by clause 5 of the Electricity Industry Participation Code Amendment (Internal Transfer Prices and Segmented Profitability Reporting) 2021.

Authority may require review of ITP information and retail gross margin reports

Heading: inserted, on 30 November 2021, by clause 5 of the Electricity Industry Participation Code Amendment (Internal Transfer Prices and Segmented Profitability Reporting) 2021.

13.261 Authority may require review of ITP information and retail gross margin reports by independent person

The **Authority** may, in its discretion, require a review by an independent person of whether—

- (a) a **generator retailer** may not have complied with one or both of clauses 13.256 or 13.257; and
- (b) a **retailer** may not have complied with clause 13.259.

Clause 13.261: inserted, on 30 November 2021, by clause 5 of the Electricity Industry Participation Code Amendment (Internal Transfer Prices and Segmented Profitability Reporting) 2021.

13.262 Nomination of independent person to undertake review

- (1) If the **Authority** requires a review under clause 13.261—
 - (a) the **Authority** must require the **generator retailer** or **retailer** to nominate an appropriate independent person to undertake the review; and
 - (b) the **generator retailer** or **retailer** must provide that nomination within a reasonable timeframe.
- (2) The **Authority** may direct the **generator retailer** or **retailer** to appoint the person nominated under subclause (1) or to nominate another person for approval.
- (3) If the **generator retailer** or **retailer** fails to nominate an appropriate person under subclause (1) within 5 **business days**, the **Authority** may direct the **generator retailer** or **retailer** to appoint a person of the **Authority's** choice.
- (4) The **generator retailer** or **retailer** must appoint a person to undertake the review in accordance with a direction made under subclause (2) or subclause (3).

Clause 13.262: inserted, on 30 November 2021, by clause 5 of the Electricity Industry Participation Code Amendment (Internal Transfer Prices and Segmented Profitability Reporting) 2021.

13.263 Factors relevant to a direction under clause 13.262

- (1) In making the direction required by clause 13.262(2) or clause 13.262(3), the **Authority** may have regard to any factors it considers relevant in the circumstances, including the following:
 - (a) the degree of independence between the **generator retailer** or **retailer** and the person nominated under clause 13.262(1); and
 - (b) the expected quality of the review; and
 - (c) the expected costs of the review.
- (2) For the purposes of subclause (1)(a), the **Authority** may have regard to the special definition of independent under clause 1.4 but it is not bound by that definition.

Clause 13.263: inserted, on 30 November 2021, by clause 5 of the Electricity Industry Participation Code Amendment (Internal Transfer Prices and Segmented Profitability Reporting) 2021.

13.264 Carrying out of review by independent person

- (1) A **generator retailer** or **retailer** subject to a review under clause 13.261 must, on request from the person undertaking the review, provide that person with such information as the person reasonably requires in order to carry out the review.
- (2) The **generator retailer** or **retailer** must provide the information no later than 10 **business days** after receiving a request from the person for the information.
- (3) The **generator retailer** or **retailer** must ensure that the person undertaking the review—
 - (a) produces a report on whether, in the opinion of that person, the **generator retailer** or **retailer** may not have complied with clauses 13.256, 13.257 or 13.259 (as specified by the **Authority** under clause 13.261); and
 - (b) submits the report to the **Authority** within the timeframe specified by the **Authority**.
- (4) The report produced under subclause (3)(a) must include any other information that the **Authority** may reasonably require.

- (5) Before the report is submitted to the **Authority**, any identified failure of the **generator retailer** or **retailer** to comply with clauses 13.256, 13.257 or 13.259 must be referred back to the **generator retailer** or **retailer** for comment.
- (6) The comments of the **generator retailer** or **retailer** must be included in the report.
Clause 13.264: inserted, on 30 November 2021, by clause 5 of the Electricity Industry Participation Code Amendment (Internal Transfer Prices and Segmented Profitability Reporting) 2021.

13.265 Payment of review costs

- (1) If a report received under clause 13.264(3)(a) establishes, to the **Authority's** reasonable satisfaction, that the **generator retailer** or **retailer** may not have complied with clauses 13.256, 13.257 or 13.259 (whether or not the **Authority** appoints an investigator to investigate the alleged breach), the **generator retailer** or **retailer** must pay the costs of the person who undertook the review.
- (2) Despite subclause (1), if a report establishes, to the **Authority's** reasonable satisfaction that any non-compliance of the **generator retailer** or **retailer** is minor or there is any other reason in the **Authority's** view that means the **generator retailer** or **retailer** should not pay the costs of the person who undertook the review, the **Authority** may, in its discretion, determine the proportion of the person's costs that the **generator retailer** or **retailer** must pay, and the **generator retailer** or **retailer** must pay those costs.
- (3) If a report establishes to the **Authority's** reasonable satisfaction that the **generator retailer** or **retailer** has complied with clauses 13.256, 13.257 and 13.259 (if relevant), the **Authority** must pay the person's costs.

Clause 13.265: inserted, on 30 November 2021, by clause 5 of the Electricity Industry Participation Code Amendment (Internal Transfer Prices and Segmented Profitability Reporting) 2021.

13.266 Requirement to provide complete and accurate information

- (1) In addition to the requirements of clause 13.2, the **generator retailer** or **retailer** must take all practicable steps to ensure that the information that the **generator retailer** or **retailer** is required to provide to any person under clauses 13.256, 13.257 or 13.259 is complete and correct.
- (2) If a **generator retailer** or **retailer** becomes aware that any information the **generator retailer** or **retailer** provided under clauses 13.256, 13.257 or 13.259 does not comply with subclause (1) or clause 13.2, even if the **generator retailer** or **retailer** has taken all practicable steps to ensure that the information complies, the **generator retailer** or **retailer** must, as soon as practicable, provide such further information as is necessary to ensure that the information provided complies with clauses 13.256, 13.257, 13.259 or clause 13.2 (as relevant).

Clause 13.266: inserted, on 30 November 2021, by clause 5 of the Electricity Industry Participation Code Amendment (Internal Transfer Prices and Segmented Profitability Reporting) 2021.

Subpart 7—Restrictions on materially large contracts

Heading: inserted, on 19 August 2022, by clause 5 of the Electricity Industry Participation Code Amendment (Restrictions on Materially Large Contracts) 2022.

Heading: revoked, on 18 May 2023, by clause 2(2) of the Electricity Industry Participation Code Amendment (Restrictions on Materially Large Contracts) 2023.

Heading: inserted, on 19 May 2023, by clause (2)(1) of the Electricity Industry Participation Code Amendment (Restrictions on Materially Large Contracts) 2022.

13.267 Contents of this subpart

This subpart provides for—

- (a) restrictions on giving effect to **materially large contracts**; and
- (b) information disclosure requirements to support compliance with this subpart; and
- (c) a clearance regime for **materially large contracts**.

Clause 13.267: inserted, on 19 August 2022, by clause 5 of the Electricity Industry Participation Code Amendment (Restrictions on Materially Large Contracts) 2022.

Clause 13.267: revoked, on 18 May 2023, by clause 2(2) of the Electricity Industry Participation Code Amendment (Restrictions on Materially Large Contracts) 2023.

Clause 13.267: inserted, on 19 May 2023, by clause 5 of the Electricity Industry Participation Code Amendment (Restrictions on Materially Large Contracts) 2023.

13.268 Definition of materially large contract

(1) A **materially large contract** is—

- (a) a contract that—
 - (i) is not entered into through a derivatives exchange; and
 - (ii) includes terms under which the **buyer** itself will consume **electricity**; and
 - (iii) relates to a net quantity of **electricity** that equals or exceeds 150 MW consumed at a point in time; or
- (b) two or more contracts where:
 - (i) all the contracts satisfy paragraph (a)(i); and
 - (ii) at least one contract satisfies paragraph (a)(ii); and
 - (iii) the contracts when taken together satisfy paragraph (a)(iii) and meet one of the descriptions set out in paragraph (c) below:
- (c) the descriptions referred to at paragraph (b)(iii) above are:
 - (i) two or more contracts between a **generator** and a **buyer**; or
 - (ii) at least one contract between a **generator** and a **buyer** and at least one contract between that **generator** or its related company and that **buyer** or its related company; or
 - (iii) at least one contract between a **generator** and a **buyer** and at least one contract involving a second **generator** and the same **buyer** where the contracts rely on each other or are otherwise interdependent; or
 - (iv) at least one contract between a **generator** and a **buyer** and at least one contract between the same **generator** and a second **generator** where the contracts rely on each other or are otherwise interdependent; or
 - (v) any other arrangement that is substantially of the same kind as that described in any of subparagraphs (i)-(iv).

(2) For **materially large contracts** made up of two or more different **generators'** contracts, any reference to **materially large contract** in the following clauses must be read as only referring to an individual **generator's** contract(s) that forms part of a **materially large contract**, rather than as a reference to the multiple **generators'** contracts.

(3) Where a **materially large contract** allows for the possibility of varying quantities of **electricity** consumption at any one time, the maximum quantity of **electricity** consumption possible under the contract at any one time is to be used for the purpose of determining whether the MW threshold in subclause (1)(a)(iii) is met.

- (4) For the purpose of subclause (1)(a)(iii), the net quantity of **electricity** is the total **MW** consumed at a point in time (calculated in accordance with subclause (3)) less any **MW** generated from new generation, where the **materially large contract** is material to the **generator's** decision to invest in the new generation.
- (5) For the purpose of this subpart, related company has the meaning set out in section 2(3) of the Companies Act 1993.
- Clause 13.268: inserted, on 19 August 2022, by clause 5 of the Electricity Industry Participation Code Amendment (Restrictions on Materially Large Contracts) 2022.\
- Clause 13.268: revoked, on 18 May 2023, by clause 2(2) of the Electricity Industry Participation Code Amendment (Restrictions on Materially Large Contracts) 2023.
- Clause 13.268: inserted, on 19 May 2023, by clause 5 of the Electricity Industry Participation Code Amendment (Restrictions on Materially Large Contracts) 2023.

13.269 Restriction on materially large contracts

- (1) A **generator** must not give effect to a **materially large contract** unless—
- (a) the net value of the **materially large contract** to the **generator** calculated in accordance with clause 13.270 is a positive value; or
 - (b) the **materially large contract** allows the **buyer** to on-sell all unused **MW** quantities under the **materially large contract** without the **buyer** being subject to any worse terms than if it had consumed the relevant quantity itself; or
 - (c) the **Authority** has provided a clearance under clause 13.273 in respect of the **materially large contract** and that clearance remains effective and applicable.
- (2) Nothing in this clause prevents a **generator** entering into a **materially large contract** that provides that it is conditional on the **Authority** providing a clearance under clause 13.273.
- (3) This clause only applies to **materially large contracts** entered into, extended or modified on or after the date this clause came into force.
- Clause 13.269: inserted, on 19 August 2022, by clause 5 of the Electricity Industry Participation Code Amendment (Restrictions on Materially Large Contracts) 2022.
- Clause 13.269: revoked, on 18 May 2023, by clause 2(2) of the Electricity Industry Participation Code Amendment (Restrictions on Materially Large Contracts) 2023.
- Clause 13.269: inserted, on 19 May 2023, by clause 5 of the Electricity Industry Participation Code Amendment (Restrictions on Materially Large Contracts) 2023.

13.270 Calculation of net value of the materially large contract to the generator

- (1) The net value of the **materially large contract** to the **generator** is the value of the contract to the **generator** less the value of the **generator's** best alternative.
- (2) The calculation of the value of the **generator's** best alternative must take into account the **generator's** reasonable expectations as to whether in the absence of the **materially large contract** the **buyer** would have exited completely, reduced consumption, not expanded, or not entered the domestic market.
- (3) The calculation of the value of the contract to the **generator** and the calculation of the value of the **generator's** best alternative must take into account any direct value components that are reasonably relevant to the calculation, which may include (without limitation)—
- (a) contract price;
 - (b) prices for baseload futures contracts over the period covered by the **materially large contract** and, where a **materially large contract** covers a period in time

not yet covered by base load futures contracts, the **generator's** reasonable expectations as to base forward prices over this period, which may include consideration of the long run marginal cost of **electricity**, the levelised cost of **electricity** and other factors:

- (c) node location:
 - (d) load profile differing from base load:
 - (e) demand response provisions:
 - (f) price separation provisions:
 - (g) contract price pegged to an index provision:
 - (h) value of maintaining an uninterrupted commercial relationship with the **buyer**:
 - (i) relative counterparty risk:
 - (j) any other financial inducements or benefits associated with the **materially large contract**.
- (4) For the avoidance of doubt, indirect effects of the **materially large contract** on the **generator's** wider portfolio (for example, revenues from other customers) must not be taken into account when calculating the value of the contract to the **generator** and the value of the **generator's** best alternative.
- (5) Each value component used under subclause (3) must be assigned a monetary value that reasonably equates to its value to the **generator**.
- (6) Each assigned monetary value for a value component must be aggregated to derive the value of the contract to the **generator** and the value of the **generator's** best alternative (as applicable).
- (7) The relevant point in time at which the **generator's** reasonable expectations at subclause (2) and any assumptions relied on under subclause (3) are to be assessed is the duration of the 30 **business days** immediately preceding the **generator** (as applicable)—
- (a) entering into the **materially large contract**; or
 - (b) seeking a clearance from the **Authority** for the **materially large contract**.

Clause 13.270: inserted, on 19 August 2022, by clause 5 of the Electricity Industry Participation Code Amendment (Restrictions on Materially Large Contracts) 2022.

Clause 13.270: revoked, on 18 May 2023, by clause 2(2) of the Electricity Industry Participation Code Amendment (Restrictions on Materially Large Contracts) 2023.

Clause 13.270: inserted, on 19 May 2023, by clause 5 of the Electricity Industry Participation Code Amendment (Restrictions on Materially Large Contracts) 2023.

13.271 Disclosure of materially large contracts

- (1) Except where clause 13.276 applies, a **generator** must provide the information specified in this clause to the **Authority** in the form and by the means specified by the **Authority** no later than 5 **business days** after—
- (a) entering into a **materially large contract**:
 - (b) changing a **materially large contract's** price, volume, term or on-selling arrangements or any other provision of a **materially large contract** that may affect the calculation of the net value of the **materially large contract** to the **generator** if the **generator** is relying on clause 13.269(1)(a) to give effect to the **materially large contract**:

- (c) changing a **materially large contract's** on-selling arrangements if the **generator** is relying on clause 13.269(1)(b) to give effect to the **materially large contract**;
- (d) a change to the volume or timing of any new generation taken into account in reliance on clause 13.268(4) where:
 - (i) the quantity of **electricity** generated from new generation has decreased; and
 - (ii) the net quantity of **electricity** for any contract exceeds the threshold in clause 13.268(1)(a)(iii).
- (2) The information to be provided must consist of the following in relation to the **materially large contract**:
 - (a) a copy of the **materially large contract** signed by the **parties**; and
 - (b) a statement of the **generator's** reasons as to how the **materially large contract** satisfies either clause 13.269(1)(a) or clause 13.269(1)(b); and
 - (c) evidence to support the **generator's** reasons at paragraph (b).
- (3) Where a **generator** seeks to rely on clause 13.269(1)(a), the evidence under subclause (2)(c) must include—
 - (a) the **generator's** calculation of the net value of the **materially large contract** to the **generator** in accordance with clause 13.270, including—
 - (i) the **generator's** calculation of the value of the contract to the **generator** and the **generator's** best alternative in accordance with clause 13.270; and
 - (ii) the value component(s) taken into account by the **generator** when calculating the value of the contract to the **generator**; and
 - (iii) the value component(s) taken into account by the **generator** when calculating the value of the **generator's** best alternative; and
 - (iv) the monetary value assigned to any value component taken into account by the **generator**; and
 - (v) a justification for the monetary value assigned to any value component, including any assumptions relied on and (if available) evidence to show whether those assumptions are consistent with similar assumptions being made elsewhere in the **generator's** business in the **60 business days** immediately preceding the date the **generator** entered into the **materially large contract**; and
 - (vi) the **generator's** reasonable expectations taken into account under clause 13.270(2) and an explanation of the basis for these expectations and (if available) evidence to support those expectations; and
 - (b) all other information and documents that are in the possession, or under the control, of the **generator** and that are material to an assessment of a **generator's** compliance with clause 13.269(1)(a).
- (4) Where a **generator** seeks to rely on clause 13.269(1)(b), the evidence under subclause (2)(c) must include—
 - (a) a statement of the **buyer's** rights to on-sell any unused **MW** quantities under the **materially large contract** and an explanation of the terms on which it can do so; and

- (b) all other information and documents that are in the possession, or under the control, of the **generator** and that are material to an assessment of a **generator's** compliance with clause 13.269(1)(b).

Clause 13.271: inserted, on 19 August 2022, by clause 5 of the Electricity Industry Participation Code Amendment (Restrictions on Materially Large Contracts) 2022.

Clause 13.271: revoked, on 18 May 2023, by clause 2(2) of the Electricity Industry Participation Code Amendment (Restrictions on Materially Large Contracts) 2023.

Clause 13.271: inserted, on 19 May 2023, by clause 5 of the Electricity Industry Participation Code Amendment (Restrictions on Materially Large Contracts) 2023.

13.272 Application to the Authority for clearance of a materially large contract

- (1) A **generator** may submit an application to the **Authority** for clearance of a **materially large contract** that—
- (a) is expressed as conditional on the **Authority** providing a clearance under this subpart; or
- (b) has not yet been signed by the **parties**.
- (2) Where a **generator** has not provided the information specified at clause 13.271 in respect of the **materially large contract** the application must include all information specified in clause 13.271 that would otherwise be required to be provided by the **generator** after entering the **materially large contract**.
- (3) The application must be submitted in the form and by the means specified by the **Authority**.

Clause 13.272: inserted, on 19 August 2022, by clause 5 of the Electricity Industry Participation Code Amendment (Restrictions on Materially Large Contracts) 2022.

Clause 13.272: revoked, on 18 May 2023, by clause 2(2) of the Electricity Industry Participation Code Amendment (Restrictions on Materially Large Contracts) 2023.

Clause 13.272: inserted, on 19 May 2023, by clause 5 of the Electricity Industry Participation Code Amendment (Restrictions on Materially Large Contracts) 2023.

13.273 Authority may provide clearance for a materially large contract

- (1) Where the **Authority** receives an application that complies with clause 13.272 the **Authority** shall either—
- (a) provide a clearance by notice in writing in respect of the **materially large contract** if it is satisfied that either clause 13.269(1)(a) or 13.269(1)(b) is met, in which case the **Authority** must specify which clause it is satisfied in respect of; or
- (b) decline by notice in writing to provide a clearance in respect of the **materially large contract** if it is not satisfied that either clause 13.269(1)(a) or 13.269(1)(b) is met, in which case the **Authority** must give the **generator** reasons for its decision.
- (2) The **Authority** may use the information provided to it in the application and any other information the **Authority** considers relevant for the purposes of its decision, including any further information the **Authority** requests from the **generator**.
- (3) The **Authority** must make a decision on the application and notify the **generator** of the outcome of its application no later than 45 **business days** after the date on which the **generator** has provided the **Authority** with all required information (including any further information requested by the **Authority** for the purpose of making its decision), or such longer period as the **Authority** and the **generator** agree.

- (4) If the period specified in subclause (3) expires without the **Authority** having provided a clearance for the **materially large contract** and without having given a notice under subclause (1)(b), the **Authority** shall be deemed to have declined to give a clearance.
- (5) The **Authority** may publish the outcome of the application.
- (6) A clearance provided by the **Authority** under this clause does not apply to a **materially large contract** if—
- (a) any changes are made to the price, volume, term, on-selling arrangements or any other provision of the **materially large contract** that may affect the calculation of the net value of the **materially large contract** to the **generator** and the **Authority** provided its clearance on the basis of clause 13.269(1)(a); or
 - (b) any changes are made to the **materially large contract's** on-selling arrangements and the **Authority** provided its clearance on the basis of clause 13.269(1)(b); or
 - (c) there has been a change to the volume or timing of any new generation taken into account in reliance on clause 13.268(4) where:
 - (i) the quantity of **electricity** generated from new generation has decreased; and
 - (ii) the net quantity of **electricity** for any contract exceeds the threshold in clause 13.268(1)(a)(iii).
- (7) Where the **Authority** provides a clearance in respect of a **materially large contract** not yet signed by the **parties**, the clearance will expire and be of no effect if the contract is not signed by the **parties** within 20 **business days** of the **Authority** providing the clearance.
- (8) The **Authority** may revoke a clearance if it was based on information provided by the **generator** that was false or misleading in a material particular.
- Clause 13.273: inserted, on 19 August 2022, by clause 5 of the Electricity Industry Participation Code Amendment (Restrictions on Materially Large Contracts) 2022.
Clause 13.273: revoked, on 18 May 2023, by clause 2(2) of the Electricity Industry Participation Code Amendment (Restrictions on Materially Large Contracts) 2023.
Clause 13.273: inserted, on 19 May 2023, by clause 5 of the Electricity Industry Participation Code Amendment (Restrictions on Materially Large Contracts) 2023.
Clause 13.273(1)(a) and (2): amended, on 1 March 2024, by clause 86(1) and (2) of the Electricity Industry Participation Code Amendment (Code Review Programme) 2024.

13.274 Reconsideration by Authority of clearance decision

- (1) Where the **Authority** declines to provide a clearance, the **Authority** may, at its discretion, reconsider its decision if—
- (a) the **generator** provides further information or reasons (which may include making changes to the **materially large contract**) to the **Authority** in support of its position no later than 10 **business days** after notification of the **Authority's** decision under clause 13.273; and
 - (b) the **Authority** considers that the further information or reasons may alter or affect the **Authority's** decision under clause 13.273.
- (2) The **Authority** must make any decisions under this clause within such timeframes as it reasonably considers appropriate.
- Clause 13.274: inserted, on 19 August 2022, by clause 5 of the Electricity Industry Participation Code Amendment (Restrictions on Materially Large Contracts) 2022.
Clause 13.274: revoked, on 18 May 2023, by clause 2(2) of the Electricity Industry Participation Code Amendment (Restrictions on Materially Large Contracts) 2023.

Clause 13.274: inserted, on 19 May 2023, by clause 5 of the Electricity Industry Participation Code Amendment (Restrictions on Materially Large Contracts) 2023.

13.275 Right of appeal against clearance decision

- (1) A party to a **materially large contract** may appeal to the **Rulings Panel** a decision by the **Authority** under clause 13.273 not to provide a clearance in respect of the **materially large contract**.
- (2) Despite subclause (1) a party to a **materially large contract** may not appeal to the **Rulings Panel** where the reason for the decision not to provide clearance relates to a failure by the **generator** to provide required information.
- (3) The appeal must be made to the **Rulings Panel** no later than **20 business days** after the **Authority** notifies the **generator** of its decision under clause 13.273.
- (4) The **Rulings Panel**, in determining an appeal, must either approve the decision of the **Authority** or direct the **Authority** to reconsider the decision in full or by reference to specified matters.

Clause 13.275: inserted, on 19 August 2022, by clause 5 of the Electricity Industry Participation Code Amendment (Restrictions on Materially Large Contracts) 2022.

Clause 13.275: revoked, on 18 May 2023, by clause 2(2) of the Electricity Industry Participation Code Amendment (Restrictions on Materially Large Contracts) 2023.

Clause 13.275: inserted, on 19 May 2023, by clause 5 of the Electricity Industry Participation Code Amendment (Restrictions on Materially Large Contracts) 2023.

13.276 Disclosure of cleared materially large contract

- (1) This clause applies to a **materially large contract** that has been provided with a clearance under clause 13.273 provided the clearance remains effective and applicable.
- (2) Where this clause applies, a **generator** must provide to the **Authority** a copy of the **materially large contract** signed by the **parties** in the form and by the means specified by the **Authority** no later than **5 business days** after entering into the **materially large contract**.

Clause 13.276: inserted, on 19 August 2022, by clause 5 of the Electricity Industry Participation Code Amendment (Restrictions on Materially Large Contracts) 2022.

Clause 13.276: revoked, on 18 May 2023, by clause 2(2) of the Electricity Industry Participation Code Amendment (Restrictions on Materially Large Contracts) 2023.

Clause 13.276: inserted, on 19 May 2023, by clause 5 of the Electricity Industry Participation Code Amendment (Restrictions on Materially Large Contracts) 2023.

13.277 Requirement to provide complete and accurate information

- (1) In addition to the requirements of clause 13.2, the **generator** must take all practicable steps to ensure that the information that the **generator** is required to provide under this subpart is complete and accurate as at the date it is required to be provided under this subpart.
- (2) If the **generator** later becomes aware that any information provided under this subpart was not complete or accurate as at the date it was required to be provided under this subpart, it must as soon as practicable provide to the **Authority** such further information as is necessary to make the information complete or accurate as at the date it was required to be provided under this subpart.

Clause 13.277: inserted, on 19 August 2022, by clause 5 of the Electricity Industry Participation Code Amendment (Restrictions on Materially Large Contracts) 2022.

Clause 13.277: revoked, on 18 May 2023, by clause 2(2) of the Electricity Industry Participation Code Amendment (Restrictions on Materially Large Contracts) 2023.

Clause 13.277: inserted, on 19 May 2023, by clause 5 of the Electricity Industry Participation Code Amendment (Restrictions on Materially Large Contracts) 2023.

13.278 Authority must keep information confidential

The **Authority** must keep all information provided to it under this subpart confidential except to the extent that disclosure is required to enable the **Authority** to carry out its obligations and duties under the Electricity Industry Act 2010, the Code or the Electricity Industry (Enforcement) Regulations or is otherwise required by law.

Clause 13.278: inserted, on 19 August 2022, by clause 5 of the Electricity Industry Participation Code Amendment (Restrictions on Materially Large Contracts) 2022.

Clause 13.278: revoked, on 18 May 2023, by clause 2(2) of the Electricity Industry Participation Code Amendment (Restrictions on Materially Large Contracts) 2023.

Clause 13.278: inserted, on 19 May 2023, by clause 5 of the Electricity Industry Participation Code Amendment (Restrictions on Materially Large Contracts) 2023.

13.279 Appointment of auditor

- (1) The **Authority** may, in its discretion, carry out an audit as to whether a **generator** has complied with this subpart.
- (2) If the **Authority** decides under subclause (1) that a **generator** should be subject to an audit—
 - (a) the **Authority** must require the **generator** to nominate an appropriate auditor; and
 - (b) the **generator** must provide that nomination to the **Authority** within a reasonable timeframe.
- (3) The **Authority** may appoint the auditor nominated by the **generator** or a different auditor, having regard to any factors it considers relevant in the circumstances, including—
 - (a) the expected quality of the audit;
 - (b) the expected costs of the audit.
- (4) If the **generator** fails to nominate an appropriate auditor within 20 **business days**, the **Authority** may appoint an auditor of its own choice.

Clause 13.279: inserted, on 19 August 2022, by clause 5 of the Electricity Industry Participation Code Amendment (Restrictions on Materially Large Contracts) 2022.

Clause 13.279: revoked, on 18 May 2023, by clause 2(2) of the Electricity Industry Participation Code Amendment (Restrictions on Materially Large Contracts) 2023.

Clause 13.279: inserted, on 19 May 2023, by clause 5 of the Electricity Industry Participation Code Amendment (Restrictions on Materially Large Contracts) 2023.

13.280 Carrying out of audit

- (1) A **generator** subject to an audit under clause 13.279 must, on request from the auditor, provide the auditor with such information as the auditor reasonably requires in order to carry out the audit.
- (2) The **generator** must provide the information no later than 20 **business days** after receiving a request from the auditor for the information.
- (3) The **generator** must ensure that the auditor provides the **Authority** with an audit report on the **generator**'s compliance with this subpart within the timeframe specified by the **Authority**.
- (4) The audit report must include any other information the **Authority** may reasonably require.

- (5) Before the audit report is provided to the **Authority**, any identified failure of the **generator** to comply with this subpart must be referred back to the **generator** for comment.
- (6) The comments of the **generator** must be included in the audit report.
- (7) The audit report must not contain any contract that the **generator** has provided to the auditor unless the contract meets the definition of a **materially large contract**.
Clause 13.280: inserted, on 19 August 2022, by clause 5 of the Electricity Industry Participation Code Amendment (Restrictions on Materially Large Contracts) 2022.
Clause 13.280: revoked, on 18 May 2023, by clause 2(2) of the Electricity Industry Participation Code Amendment (Restrictions on Materially Large Contracts) 2023.
Clause 13.280: inserted, on 19 May 2023, by clause 5 of the Electricity Industry Participation Code Amendment (Restrictions on Materially Large Contracts) 2023.

13.281 Payment of costs relating to audits

- (1) If an audit establishes, to the reasonable satisfaction of the **Authority**, that a **generator** may not have complied with this subpart (whether or not the **Authority** appoints an investigator to investigate the alleged breach), the **generator** must pay for the audit.
- (2) If the **Authority** considers that the non-compliance of the **generator** is minor or there is any other reason in the **Authority's** view that means the **generator** should not pay the costs of the audit, the **Authority** may, in its discretion, determine the proportion of the costs of the audit that are to be paid by the **generator**, and those costs must be paid by the **generator** with any remaining proportion of costs paid by the **Authority**.
- (3) If an audit establishes to the reasonable satisfaction of the **Authority** that the **generator** has complied with this subpart, the **generator** is not required to pay any of the auditor's costs and the **Authority** will pay the auditor's costs.
Clause 13.281: inserted, on 19 August 2022, by clause 5 of the Electricity Industry Participation Code Amendment (Restrictions on Materially Large Contracts) 2022.
Clause 13.281: revoked, on 18 May 2023, by clause 2(2) of the Electricity Industry Participation Code Amendment (Restrictions on Materially Large Contracts) 2023.
Clause 13.281: inserted, on 19 May 2023, by clause 5 of the Electricity Industry Participation Code Amendment (Restrictions on Materially Large Contracts) 2023.
Clause 13.281(2): amended, on 1 March 2024, by clause 87 of the Electricity Industry Participation Code Amendment (Code Review Programme) 2024.

13.282 Transitional arrangements

- (1) Where:
 - (a) an application has been made to the **Authority** for clearance of a **materially large contract** pursuant to clause 13.272 prior to 19 May 2023; and
 - (b) as at 19 May 2023:
 - (i) the **Authority** has not yet made a decision on the application and notified the **generator** of the outcome; and
 - (ii) the period specified in clause 13.272(3) has either:
 - (A) not yet expired; or
 - (B) has been extended by agreement between the **Authority** and the **generator**;
- then, the **Authority** shall make a decision on the application as if this subpart, as it existed on 18 May 2023, continued in force.

- (2) Once the **Authority** has made a decision on an application to which subclause (1) applies, the matters and arrangements which were subject of the application shall be dealt with in accordance with this subpart.
- (3) Where:
- (a) an application has been made to the **Authority** for clearance of a **materially large contract** pursuant to clause 13.272 prior to 19 May 2023; and
 - (b) the **Authority** has, pursuant to clause 13.273(1)(a), provided a clearance by notice in writing prior to 19 May 2023;
- then, the **materially large contract** and the matters and arrangements which were subject of the application, shall be dealt with in accordance with this subpart.

Clause 13.282: inserted, on 19 May 2023, by clause 5 of the Electricity Industry Participation Code Amendment (Restrictions on Materially Large Contracts) 2023.

Schedule 13.1
Forms 1 to 9

cls 13.9, 13.13, 13.38 and 13.64

Heading: amended, on 1 November 2022, by clause 153 of the Electricity Industry Participation Code Amendment (Real Time Pricing) 2022.

Form 1
Generator offer

Date: _____

Generator Participant Identifier: _____

Generator Name: _____

Grid Injection Point: _____

Generator Category (clause 13.10 of the Code): Unit Station
 Generator block (clauses 13.60 and 13.61 of the Code)

Block Name (if applicable): _____

Generator Maximum Output (including overload): _____ **MW**

Trading Period: _____ Starting at _____ : _____ 0 hours

Maximum Generator Ramp Up Rate: _____ **MW/hr**

Maximum Generator Ramp Down Rate: _____ **MW/hr**

Offer is submitted by dispatch notification generator:

Offer to sell electricity

Band 1: **From 0 MW to** _____ **MW @ \$** _____ **per MWh**

Band 2: **plus** _____ **MW @ \$** _____ **per MWh**

Band 3: **plus** _____ **MW @ \$** _____ **per MWh**

Band 4: **plus** _____ **MW @ \$** _____ **per MWh**

Band 5: **plus** _____ **MW @ \$** _____ **per MWh**

Compare: Electricity Governance Rules 2003 form 1 schedule G1 part G
Schedule 13.1, Form 1: amended, on 27 May 2015, by clause 14 of the Electricity Industry Participation Code Amendment (Industrial Co-generation Dispatch Arrangements) 2015.
Schedule 13.1, Form 1: amended, on 1 November 2022, by clause 154 of the Electricity Industry Participation Code Amendment (Real Time Pricing) 2022.

Form 2
Intermittent Generator Offer

Date: _____

Intermittent Generator Participant Identifier: _____

Intermittent Generator Name: _____

Grid Injection Point: _____

Generator category (clause 13.10 of the Code): Station

Generator Installed Capacity: _____ MW

Trading Period: _____ Starting at _____ : _____ 0 hours

Maximum Generator Ramp Up Rate: _____ MW/hr

Maximum Generator Ramp Down Rate: _____ MW/hr

Offer to sell electricity

Band 1: **From 0 MW to** _____ **MW @ \$** _____ **per MWh**

Band 2: **plus** _____ **MW @ \$** _____ **per MWh**

Band 3: **plus** _____ **MW @ \$** _____ **per MWh**

Band 4: **plus** _____ **MW @ \$** _____ **per MWh**

Band 5: **plus** _____ **MW @ \$** _____ **per MWh**

Forecast of generation potential: _____ **MW**

Compare: Electricity Governance Rules 2003 form 2 schedule G1 part G
Schedule 13.1, Form 2: amended, on 27 May 2015, by clause 15 of the Electricity Industry Participation Code Amendment (Industrial Co-generation Dispatch Arrangements) 2015.
Schedule 13.1, Form 2: amended, at 12.00 pm on 19 September 2019, by clause 29 of the Electricity Industry Participation Code Amendment (Wind Offer Arrangements) 2019.

Form 3
Type A or Type B Co-generator Offer

Date: _____

Type A/Type B Co-generator
Participant Identifier: _____

Type A/Type B Co-generator
Name: _____

Grid Injection Point: _____

Generator Category (clause 13.10 of the Code): Unit Station

Type A/Type B Co-generator Maximum Output (including overload):
_____ MW

Trading Period: _____ Starting at _____ : _____ 0 hours

Maximum Generator Ramp Up Rate:
_____ MW/hr

Maximum Generator Ramp Down Rate:
_____ MW/hr

Offer to sell electricity

Band 1: **From 0 MW to _____ MW @ \$ _____ per MWh**

Band 2: **plus _____ MW @ \$ _____ per MWh**

Compare: Electricity Governance Rules 2003 form 2A schedule G1 part G
Schedule 13.1, Form 3 heading: amended, on 27 May 2015, by clause 16(1) of the Electricity Industry Participation Code
Amendment (Industrial Co-generation Dispatch Arrangements) 2015.
Schedule 13.1, Form 3: amended, on 27 May 2015, by clause 16(2) of the Electricity Industry Participation Code Amendment
(Industrial Co-generation Dispatch Arrangements) 2015.

Form 4

Purchaser's nominated bid for electricity

Date: _____
Purchaser: _____
Grid Exit Point: _____
Trading Period: _____ starting at _____ : _____ 0 hours
Type of bid: Nominated dispatch bid
Nominated non-dispatch bid
Dispatch-capable load station identifier (if applicable): _____
Bid is submitted by dispatch notification purchaser:

Nominated bid to buy electricity

Band 1: From 0 MW to _____	MW below \$ _____	per MWh
Band 2: plus _____	MW below \$ _____	per MWh
Band 3: plus _____	MW below \$ _____	per MWh
Band 4: plus _____	MW below \$ _____	per MWh
Band 5: plus _____	MW below \$ _____	per MWh
Band 6: plus _____	MW below \$ _____	per MWh
Band 7: plus _____	MW below \$ _____	per MWh
Band 8: plus _____	MW below \$ _____	per MWh
Band 9: plus _____	MW below \$ _____	per MWh
Band 10: plus _____	MW below \$ _____	per MWh

Compare: Electricity Governance Rules 2003 form 3 schedule G1 part G
Schedule 13.1 Form 4: amended, on 28 June 2012, by clause 51 of the Electricity Industry Participation (Demand-side Bidding and Forecasting) Code Amendment 2011.
Schedule 13.1 Form 4: substituted, on 15 May 2014, by clause 68 of the Electricity Industry Participation (Modified Dispatchable Demand) Code Amendment 2013.
Schedule 13.1, Form 4: amended, on 1 November 2022, by clause 155 of the Electricity Industry Participation Code Amendment (Real Time Pricing) 2022.

Form 4A
Purchaser's difference bid for electricity

Date:

Purchaser:

Grid Exit Point:

Trading Period: _____ starting at _____ : _____ 0 hours

Difference bid to increase/ decrease use of electricity

Increase electricity

Band 1: **Increase** _____ MW below \$ _____ per MWh

Band 2: **plus** _____ MW below \$ _____ per MWh

Band 3: **plus** _____ MW below \$ _____ per MWh

Band 4: **plus** _____ MW below \$ _____ per MWh

Band 5: **plus** _____ MW below \$ _____ per MWh

Decrease electricity

Band 1: **Decrease** _____ MW above \$ _____ per MWh

Band 2: **plus** _____ MW above \$ _____ per MWh

Band 3: **plus** _____ MW above \$ _____ per MWh

Band 4: **plus** _____ MW above \$ _____ per MWh

Band 5: **plus** _____ MW above \$ _____ per MWh

Schedule 13.1 Form 4A: inserted, on 28 June 2012, by clause 52 of the Electricity Industry Participation (Demand-side Bidding and Forecasting) Code Amendment 2011.

Form 5
Generation Reserve Offer

Date: _____

Ancillary Service Agent:

Generator Name: _____

Grid Injection Point: _____

Trading Period: _____ Starting at _____ 0 hours

Offer to provide reserve

(1) Partly Loaded Spinning Reserve

Band 1:

_____ % of electricity (MW), up to a maximum of _____ MW as Fast Instantaneous Reserve @ \$ _____ per MW

_____ % of electricity (MW), up to a maximum of _____ MW as Sustained Instantaneous Reserve @ \$ _____ per MW

Band 2:

_____ % of electricity (MW), up to a maximum of _____ MW as Fast Instantaneous Reserve @ \$ _____ per MW

_____ % of electricity (MW), up to a maximum of _____ MW as Sustained Instantaneous Reserve @ \$ _____ per MW

Band 3:

_____ % of electricity (MW), up to a maximum of _____ MW as Fast Instantaneous Reserve @ \$ _____ per MW

_____ % of electricity (MW), up to a maximum of _____ MW as Sustained Instantaneous Reserve @ \$ _____ per MW

(2) All other forms of generation reserve

Band 1:

Up to a maximum of _____ MW @ \$ _____ per MW as Fast Instantaneous Reserve

Up to a maximum of _____ MW @ \$ _____ per MW as Sustained Instantaneous Reserve

Electricity Industry Participation Code 2010
Schedule 13.1

Band 2:

Up to a maximum of _____ **MW @ \$** _____ per **MW** as Fast Instantaneous Reserve

Up to a maximum of _____ **MW @ \$** _____ per **MW** as Sustained Instantaneous Reserve

Band 3:

Up to a maximum of _____ **MW @ \$** _____ per **MW** as Fast Instantaneous Reserve

Up to a maximum of _____ **MW @ \$** _____ per **MW** as Sustained Instantaneous Reserve

Compare: Electricity Governance Rules 2003 form 4 schedule G1 part G

Schedule 13.1 Form 5: amended, on 15 May 2014, by clause 50 of the Electricity Industry Participation (Minor Code Amendments) Code Amendment 2014.

Schedule 13.1 Form 5: amended, on 3 May 2022, by clause 9(1) and (2) of the Electricity Industry Participation Code Amendment (Enabling Energy Storage Systems to Offer Instantaneous Reserve) 2022.

Form 6
Interruptible Load Offer

Date: _____

Ancillary Service Agent:

Grid Exit Point or interruptible load group GXP:

Dispatch-capable load station identifier (if applicable): _____

Instantaneous reserve capability

Holds a Reserve Contract with the System Operator Yes

Fast Instantaneous Reserve Interruptible Load Available Yes

Sustained Interruptible Load Available Yes

Trading Period: _____ Starting at _____ : _____ 0 hours

Offer to provide reserve

1 Interruptible load

Band 1:

Up to a maximum of _____ MW @ \$ _____ per MW as Fast Instantaneous Reserve

Up to a maximum of _____ MW @ \$ _____ per MW as Sustained Instantaneous Reserve

Band 2:

Up to a maximum of _____ MW @ \$ _____ per MW as Fast Instantaneous Reserve

Up to a maximum of _____ MW @ \$ _____ per MW as Sustained Instantaneous Reserve

Band 3:

Up to a maximum of _____ MW @ \$ _____ per MW as Fast Instantaneous Reserve

Up to a maximum of _____ MW @ \$ _____ per MW as Sustained Instantaneous Reserve

Compare: Electricity Governance Rules 2003 form 5 schedule G1 part G
Schedule 13.1 Form 6: amended, on 15 May 2014, by clause 51 of the Electricity Industry Participation (Minor Code Amendments) Code Amendment 2014.
Schedule 13.1, Form 6: amended, on 1 November 2022, by clause 156 of the Electricity Industry Participation Code Amendment (Real Time Pricing) 2022.

Form 7
Instantaneous Reserve Parameters

Date: _____

Trading Period: _____ Starting at _____ : _____ 0 hours

North Island Fast Instantaneous Reserve Adjustment Factor

North Island Sustained Instantaneous Reserve Adjustment Factor

South Island Fast Instantaneous Reserve Adjustment Factor

South Island Sustained Instantaneous Reserve Adjustment Factor

Minimum Risk

North Island Minimum Risk

_____ **MW**

South Island Minimum Risk

_____ **MW**

Compare: Electricity Governance Rules 2003 form 6 schedule G1 part G
Schedule 13.1 Form 7: amended, on 15 May 2014, by clause 52 of the Electricity Industry Participation (Minor Code Amendments) Code Amendment 2014.

Form 8
Notice of Station Dispatch Group

Date:

Generator:

[*Insert name of generator*] hereby gives the **system operator** notice pursuant to clause 13.64 of the Code that the following group of **generating units** and/or **generating stations** are to be treated as a **station dispatch group**:

Name of Station Dispatch Group:

Station Identifier:

Constituent units:

Grid Injection Point (GIP)	Station/ generating unit name

This notice is to be effective from 0000 hours on [insert date], being at least 15 **business days** after the date of this notice, and remains in force until cancelled in writing by [insert name of generator].

Generator Control centre:

Name: _____

Contact Number: Ph: _____ Ph: _____

Address: _____

Yours sincerely

[Name of sender]

[Generator name]

Compare: Electricity Governance Rules 2003 form 7 schedule G1 part G
Schedule 13.1, Form 8: amended, on 5 October 2017, by clause 483 of the Electricity Industry Participation Code Amendment (Code Review Programme) 2017.

Form 9
Claim of pricing error

Compare: Electricity Governance Rules 2003 form 8 schedule G1 part G
Schedule 13.1 Form 9: amended, on 15 May 2014, by clause 53 of the Electricity Industry Participation (Minor Code Amendments) Code Amendment 2014.
Schedule 13.1, Form 9: revoked, on 1 November 2022, by clause 157 of the Electricity Industry Participation Code Amendment (Real Time Pricing) 2022.

Schedule 13.2

cls 13.58AA and 13.189

Model parameters

Heading: amended, on 1 November 2022, by clause 158 of the Electricity Industry Participation Code Amendment (Real Time Pricing) 2022.

1 Model parameters

The **system operator** must, in accordance with clause 13.189 of the Code, provide the **Authority** with a list specifying the values for the following model parameters:

- (a) deficit bus generation:
- (b) surplus bus generation:
- (c) deficit 6s reserve for a contingent event as defined in clause 12.3 of the Policy Statement:
- (d) deficit 6s reserve for an extended contingent event as defined in clause 12.3 of the Policy Statement:
- (e) deficit 60s reserve for a contingent event as defined in clause 12.3 of the Policy Statement:
- (f) deficit 60s reserve for an extended contingent event as defined in clause 12.3 of the Policy Statement:
- (g) deficit branch group constrained:
- (h) surplus branch group constrained:
- (i) deficit bus group constrained:
- (j) surplus bus group constrained:
- (k) deficit ramp rate:
- (l) surplus ramp rate:
- (m) market node/trader capacity deficit:
- (n) deficit branch flow:
- (o) surplus branch flow:
- (p) deficit M-node constrained:
- (q) surplus M-node constrained.

Compare: Electricity Governance Rules 2003 schedule G2 part G
Schedule 13.2, Clause 1: amended, on 1 November 2022, by clause 159 of the Electricity Industry Participation Code Amendment (Real Time Pricing) 2022.

Schedule 13.3 The Modelling System

cls 13.29, 13.33, 13.57, 13.58, 13.58AA, 13.58A, 13.69A, 13.69AA, 13.193, and 13.203

Heading: amended, on 28 June 2012, by clause 53 of the Electricity Industry Participation (Demand-side Bidding and Forecasting) Code Amendment 2011.

Heading: substituted, on 15 May 2014, by clause 54(1) of the Electricity Industry Participation (Minor Code Amendments) Code Amendment 2014.

Heading: amended, on 1 November 2022, by clause 160 of the Electricity Industry Participation Code Amendment (Real Time Pricing) 2022.

Inputs into the modelling system

1 Purpose of modelling system

- (1) The purpose of the modelling system is to provide schedules of quantities and prices that maximise the gross **purchaser** benefit from purchases of **electricity** from the **clearing manager** less the total cost of production of **electricity** and **instantaneous reserves** as specified in this Schedule.
- (2) *[Revoked]*
- (2A) A **price-responsive schedule** and **non-response schedule** must use the scheduled generation at the end of the previous **trading period** as the expected output for the purpose of clause 9A(b).
- (3) The modelling system must provide prices for **electricity** and **instantaneous reserve** that are consistent with the above purpose and the scheduled quantities of **electricity** and **instantaneous reserve**.
- (4) The modelling system must be used, using different inputs, to produce—
 - (a) **price-responsive schedules**; and
 - (b) **non-response schedules**; and
 - (c) **dispatch schedules**
 - (d) *[Revoked]*
 - (e) *[Revoked]*
 - (f) *[Revoked]*
 - (g) *[Revoked]*

Compare: Electricity Governance Rules 2003 clause 1.1 schedule G6 part G

Clause 1 Heading: amended, on 15 May 2014, by clause 54(2) of the Electricity Industry Participation (Minor Code Amendments) Code Amendment 2014.

Clause 1(1): amended, on 28 June 2012, by clause 54(1) of the Electricity Industry Participation (Demand-side Bidding and Forecasting) Code Amendment 2011.

Clause 1(1): amended, on 21 September 2012, by clause 32(1) of the Electricity Industry Participation (Minor Amendments) Code Amendment 2012.

Clause 1(2): substituted, on 15 May 2014, by clause 69 of the Electricity Industry Participation (Modified Dispatchable Demand) Code Amendment 2013.

Clause 1(2): revoked, on 1 November 2022, by clause 161(1) of the Electricity Industry Participation Code Amendment (Real Time Pricing) 2022.

Clause 1(2A): inserted, on 15 May 2014, by clause 69 of the Electricity Industry Participation (Modified Dispatchable Demand) Code Amendment 2013.

Clause 1(2A): amended, on 1 November 2022, by clause 161(2) of the Electricity Industry Participation Code Amendment (Real Time Pricing) 2022.

Clause 1(3): amended, on 28 June 2012, by clause 54(2) of the Electricity Industry Participation (Demand-side Bidding and Forecasting) Code Amendment 2011.

Clause 1(4): substituted, on 28 June 2012, by clause 54(3) of the Electricity Industry Participation (Demand-side Bidding and Forecasting) Code Amendment 2011.

Clause 1(4)(c): amended, on 1 November 2022, by clause 161(3) of the Electricity Industry Participation Code Amendment (Real Time Pricing) 2022.

Clauses 1(4)(d) to (g): revoked, on 1 November 2022, by clause 161(4) of the Electricity Industry Participation Code Amendment (Real Time Pricing) 2022.

2 *[Revoked]*

Compare: Electricity Governance Rules 2003 clause 1.2 schedule G6 part G

Clause 2 Heading: amended, on 28 June 2012, by clause 55(1) of the Electricity Industry Participation (Demand-side Bidding and Forecasting) Code Amendment 2011.

Clause 2(a), (c), (d) and (e): amended, on 28 June 2012, by clause 55(2) of the Electricity Industry Participation (Demand-side Bidding and Forecasting) Code Amendment 2011.

Clause 2(b): revoked, on 28 June 2012, by clause 55(2)(c) of the Electricity Industry Participation (Demand-side Bidding and Forecasting) Code Amendment 2011.

Clause 2(c): amended, on 15 May 2014, by clause 70 of the Electricity Industry Participation (Modified Dispatchable Demand) Code Amendment 2013.

Clause 2: revoked, on 1 November 2022, by clause 162 of the Electricity Industry Participation Code Amendment (Real Time Pricing) 2022.

Inputs used at each stage

3 **Specific inputs must be used in schedules**

The schedules must be prepared using the following inputs:

(a) for each **price-responsive schedule**, the inputs set out in clause 13.58A(1)

(b) for each **non-response schedule**, the inputs set out in clause 13.58A(2)

(c) for each **dispatch schedule**, the inputs set out in clause 13.69B

(d) *[Revoked]*

(e) *[Revoked]*

Compare: Electricity Governance Rules 2003 clause 1.3 schedule G6 part G

Clause 3: substituted, on 28 June 2012, by clause 56 of the Electricity Industry Participation (Demand-side Bidding and Forecasting) Code Amendment 2011.

Clause 3: amended, on 1 November 2022, by clause 163(1) of the Electricity Industry Participation Code Amendment (Real Time Pricing) 2022.

Clause 3(c): amended, on 1 November 2022, by clause 163(2) of the Electricity Industry Participation Code Amendment (Real Time Pricing) 2022.

Clause 3(d) and (e): revoked, on 1 November 2022, by clause 163(3) of the Electricity Industry Participation Code Amendment (Real Time Pricing) 2022.

4 *[Revoked]*

Clause 4: revoked, on 28 June 2012, by clause 57 of the Electricity Industry Participation (Demand-side Bidding and Forecasting) Code Amendment 2011.

5 *[Revoked]*

Clause 5: revoked, on 28 June 2012, by clause 57 of the Electricity Industry Participation (Demand-side Bidding and Forecasting) Code Amendment 2011.

6 *[Revoked]*

Compare: Electricity Governance Rules 2003 clause 1.3.3 schedule G6 part G

Clause 6 Heading: amended, on 28 June 2012, by clause 58(1) of the Electricity Industry Participation (Demand-side Bidding and Forecasting) Code Amendment 2011.

Clause 6: amended, on 28 June 2012, by clause 58(2) of the Electricity Industry Participation (Demand-side Bidding and Forecasting) Code Amendment 2011.

Clause 6(a): substituted, on 15 May 2014, by clause 71(1) of the Electricity Industry Participation (Modified Dispatchable Demand) Code Amendment 2013.

Clause 6(1)(a)(v): inserted, at 12.00 pm on 19 September 2019, by clause 30(1) of the Electricity Industry Participation Code Amendment (Wind Offer Arrangements) 2019.

Clause 6(c): amended, on 15 May 2014, by clause 71(2) of the Electricity Industry Participation (Modified Dispatchable Demand) Code Amendment 2013.

Clause 6(c): amended, on 15 May 2014, by clause 54(3) of the Electricity Industry Participation (Minor Code Amendments) Code Amendment 2014.

Clauses 6(2) and (3): inserted, at 12.00 pm on 19 September 2019, by clause 30(2) of the Electricity Industry Participation Code Amendment (Wind Offer Arrangements) 2019.

Clause 6: revoked, on 1 November 2022, by clause 164 of the Electricity Industry Participation Code Amendment (Real Time Pricing) 2022.

7 *[Revoked]*

Compare: Electricity Governance Rules 2003 clause 1.3.4 schedule G6 part G

Clause 7 Heading: amended, on 28 June 2012, by clause 59(1) of the Electricity Industry Participation (Demand-side Bidding and Forecasting) Code Amendment 2011.

Clause 7: amended, on 28 June 2012, by clause 59(2) of the Electricity Industry Participation (Demand-side Bidding and Forecasting) Code Amendment 2011.

Clause 7(a): substituted, on 27 May 2015, by clause 17 of the Electricity Industry Participation Code Amendment (Industrial Co-generation Dispatch Arrangements) 2015.

Clause 7(a)(i), (a)(ii) and (d): revoked, at 12.00 pm on 19 September 2019, by clause 31(a) of the Electricity Industry Participation Code Amendment (Wind Offer Arrangements) 2019.

Clause 7(b): substituted, on 28 June 2012, by clause 59(2)(b) of the Electricity Industry Participation (Demand-side Bidding and Forecasting) Code Amendment 2011.

Clause 7(b): substituted, on 15 May 2014, by clause 72(a) of the Electricity Industry Participation (Modified Dispatchable Demand) Code Amendment 2013.

Clause 7(e): replaced, at 12.00 pm on 19 September 2019, by clause 31(b) of the Electricity Industry Participation Code Amendment (Wind Offer Arrangements) 2019.

Clause 7(g)(i) and (iii): amended, on 20 December 2021, by clause 61 of the Electricity Industry Participation Code Amendment (Code Review Programme) 2019.

Clause 7(g)(ii): substituted, on 1 November 2012, by clause 6(1) of the Electricity Industry Participation (HVDC Link Pole 3 Standing Data) Code Amendment 2012.

Clause 7(i): amended, on 15 May 2014, by clause 72(b) of the Electricity Industry Participation (Modified Dispatchable Demand) Code Amendment 2013.

Clause 7: revoked, on 1 November 2022, by clause 165 of the Electricity Industry Participation Code Amendment (Real Time Pricing) 2022.

The objective function

8 The objective function

(1) The objective function of the modelling system is described mathematically as:

$$\begin{array}{l}
 \text{Maximise} \left\{ \begin{array}{l}
 \text{Gross Consumer Benefit} \\
 \overbrace{\sum_{i,j} D_{i,j} \times BP_{i,j}} \\
 \text{minus} \\
 \text{Cost of Generation} \\
 \overbrace{\sum_{i,j} G_{i,j} \times OP_{i,j}} \\
 \text{minus} \\
 \text{Cost of Fast Instantaneous Reserves} \\
 \overbrace{\sum_{i,j} R_{i,j}^{GR,f} \times OP_{i,j}^{GR,f} + \sum_{i,j} R_{i,j}^{IL,f} \times OP_{i,j}^{IL,f}} \\
 \text{minus} \\
 \text{Cost of Sustained Instantaneous Reserves} \\
 \overbrace{\sum_{i,j} R_{i,j}^{GR,s} \times OP_{i,j}^{GR,s} + \sum_{i,j} R_{i,j}^{IL,s} \times OP_{i,j}^{IL,s}}
 \end{array} \right\}
 \end{array}$$

where

i is a price band of a **bid** / **offer** or a **reserve offer**

j is a **generating unit** / **generating station**, or a **purchaser**

$D_{i,j}$ is the scheduled **demand** corresponding to price band i of the **bid** for **purchaser** j where the relevant **bids** used here are formed from a combination of the following, as appropriate to the schedule being calculated:

- (a) **nominated bids**:
- (b) the forecast prepared under clause 13.7A(1):
- (c) **difference bids** (if **difference bids** are used, the quantities must be added or subtracted, as appropriate, from the forecast prepared under clause 13.7A(1)):
- (d) the **system operator's** expectation of the profile of **demand** during the relevant period covered by the schedule being calculated:

$BP_{i,j}$ is the **bid** prices corresponding to price band i of the **bid** for **purchaser** j where the relevant **bid** prices used here are formed from a combination of the following, as appropriate to the schedule being calculated:

- (a) **nominated bids**:
- (b) the values assigned under clause 13.58AA(1).

$G_{i,j}$ is the scheduled generation corresponding to price band i of the **offer** for unit / station j

$OP_{i,j}$ is the **offer** price corresponding to price band i of the **offer** for unit / station j

$R_{i,j}^{GR,f}$ is the scheduled fast GR corresponding to price band i of the fast **reserve offer** for unit / station j

$R_{i,j}^{GR,s}$ is the scheduled sustained GR corresponding to price band i of the **reserve offer** for unit / station j

$OP_{i,j}^{GR,f}$ is the **reserve offer** price corresponding to price band i of the fast GR **reserve offer** for unit / station j

$OP_{i,j}^{GR,s}$ is the **reserve offer** price corresponding to price band i of the sustained GR **reserve offer** for unit / station j

$R_{i,j}^{IL,f}$ is the scheduled fast IL corresponding to price band i of the **reserve offer** for **purchaser** j

$R_{i,j}^{IL,s}$ is the scheduled sustained IL corresponding to price band i of the **reserve offer** for **purchaser j**

$OP_{i,j}^{IL,f}$ is the **reserve offer** price corresponding to price band i of the fast IL **reserve offer** for **purchaser j**

$OP_{i,j}^{IL,s}$ is the **reserve offer** price corresponding to price band i of the sustained IL **reserve offer** for **purchaser j**

and where

GR is **generation reserve**

IL is **interruptible load**

fast is **fast instantaneous reserve**

sustained is **sustained instantaneous reserve**.

(2) The objective must be maximised to an accuracy specified in the **model formulation**.

Compare: Electricity Governance Rules 2003 clause 2 schedule G6 part G

Clause 8, definition of D_{ij} : amended, on 28 June 2012, by clause 60 of the Electricity Industry Participation (Demand-side Bidding and Forecasting) Code Amendment 2011.

Clause 8(1) definition of D_{ij} : amended, on 15 May 2014, by clause 73 of the Electricity Industry Participation (Modified Dispatchable Demand) Code Amendment 2013.

Clause 8(1): amended, on 3 May 2022, by clause 10 of the Electricity Industry Participation Code Amendment (Enabling Energy Storage Systems to Offer Instantaneous Reserve) 2022.

Clause 8(1) definition of D_{ij} : amended, on 1 November 2022, by clause 166(1) of the Electricity Industry Participation Code Amendment (Real Time Pricing) 2022.

Clause 8(1) definition of BP_{ij} : amended, on 1 November 2022, by clause 166(2) of the Electricity Industry Participation Code Amendment (Real Time Pricing) 2022.

9 Constraints

In maximising the objective function, the **system operator** must ensure that the following constraints are met to an accuracy specified in the **model formulation**:

- (a) *[Revoked]*
- (b) each constraint relating to **generation** set out in clause 9A:
- (c) the constraint relating to **demand** set out in clause 10:
- (d) each constraint relating to the transmission system set out in clause 11:
- (e) each constraint relating to **instantaneous reserve** set out in clause 12.

Compare: Electricity Governance Rules 2003 clauses 3 and 3.1 schedule G6 part G

Clause 9: amended, on 28 June 2012, by clause 61 of the Electricity Industry Participation (Demand-side Bidding and Forecasting) Code Amendment 2011.

Clause 9: amended, on 15 May 2014, by clause 74 of the Electricity Industry Participation (Modified Dispatchable Demand) Code Amendment 2013.

Clause 9: amended, on 1 November 2022, by clause 167 of the Electricity Industry Participation Code Amendment (Real Time Pricing) 2022.

9A Constraints relating to generation

The constraints for the purpose of clause 9(b) are that—

- (a) for each price band, the modelling system does not schedule **electricity** generation that would result in the scheduled quantity of **electricity** to be generated by a **generator** being greater than the quantity offered by the **generator** for the price band; and
- (b) the modelling system schedules **electricity** generation for each **generating unit** or **generating station** in a **trading period** within the offered maximum ramp up and ramp down rates of the **generating unit** or **generating station**, given the expected (or actual) output at the start of the **trading period**; and
- (c) the modelling system schedules **electricity** generation for each **intermittent generating station** in a **trading period** at a level that is no higher than the potential output of the **intermittent generating station**, determined as follows:
 - (i) in relation to the **price-responsive schedule**, in accordance with clause 13.58A(1)(aa):
 - (ii) in relation to the **non-response schedule**, in accordance with clause 13.58A(2)(aa):
 - (iii) in relation to the **dispatch schedule**, in accordance with clause 13.71(3):
 - (iv) in relation to the **input information** referred to in clause 13.141, in accordance with clause 13.141(1)(caa):
 - (v) *[Revoked]*

Clause 9A: inserted, on 15 May 2014, by clause 75 of the Electricity Industry Participation (Modified Dispatchable Demand) Code Amendment 2013.

Clause 9A(b): amended, at 12.00 pm on 19 September 2019, by clause 32(1) of the Electricity Industry Participation Code Amendment (Wind Offer Arrangements) 2019.

Clause 9A(c): inserted, at 12.00 pm on 19 September 2019, by clause 32(2) of the Electricity Industry Participation Code Amendment (Wind Offer Arrangements) 2019.

Clause 9A(c)(v): revoked, on 1 November 2022, by clause 168 of the Electricity Industry Participation Code Amendment (Real Time Pricing) 2022.

10 Constraint relating to demand

The constraint relating to **demand** for the purpose of clause 9(c) is that, for each price band, the modelling system does not schedule **electricity demand** that would result in the scheduled quantity of **demand** being greater than the quantity bid by the **purchaser** for the price band.

Compare: Electricity Governance Rules 2003 clause 3.2 schedule G6 part G

Clause 10: substituted, on 28 June 2012, by clause 62 of the Electricity Industry Participation (Demand-side Bidding and Forecasting) Code Amendment 2011.

Clause 10: substituted, on 15 May 2014, by clause 76 of the Electricity Industry Participation (Modified Dispatchable Demand) Code Amendment 2013.

11 Constraints relating to transmission system

The final schedule provided by the modelling system must have the following characteristics (all of which must be met to an accuracy to be specified in the **model formulation**):

- (a) the total scheduled flow into and out of a **grid injection point** or **grid exit point** must equal 0 for all **grid injection points** and **grid exit points**:
- (b) the modelling system must calculate **losses** in transmission lines, the **HVDC link**, and transformers. Those **losses** must be approximated using the information

provided by **grid owners** under clauses 13.29 to 13.31, for transmission **lines**, the **HVDC link** and transformers respectively:

- (c) the modelling system must calculate the **electricity** flows into individual transmission **lines** and flows into the connection points of transformers connected at the same **grid injection point** or **grid exit point** using an established DC power flow technique within the limitations imposed by the technique that—
 - (i) correctly adjusts flows for transmission system **losses**; and
 - (ii) correctly apportions flows in transmission system loops, whether or not those loops contain transmission **constraints**

Compare: Electricity Governance Rules 2003 clause 3.3 schedule G6 part G

Clause 11 Heading: amended, on 15 May 2014, by clause 77 of the Electricity Industry Participation (Modified Dispatchable Demand) Code Amendment 2013.

Clause 11(b) and (c): amended, on 1 February 2016, by clause 88 of the Electricity Industry Participation Code Amendment (Code Review Programme) 2015.

Clause 11(c): amended, on 23 February 2015, by clause 75 of the Electricity Industry Participation Code Amendment (Distributed Generation) 2014.

Clause 11(c): amended, on 5 October 2017, by clause 484 of the Electricity Industry Participation Code Amendment (Code Review Programme) 2017.

Clause 11(c): amended, on 1 November 2022, by clause 169 of the Electricity Industry Participation Code Amendment (Real Time Pricing) 2022.

12 Constraints relating to instantaneous reserve

- (1) The modelling system must simultaneously calculate the amount of **fast instantaneous reserve** and **sustained instantaneous reserve** to be provided by each **ancillary service agent** in each **island** to meet the requirements of the **dispatch objective** in each **island**.
- (2) In making the calculation in subclause (1), the modelling system must identify the risk (in **MW**) associated with the largest “Contingent Event” as the largest of—
 - (a) the transfer on a single pole of the **HVDC link**; or
 - (b) the generation from a single **generating unit** (whether or not this is a **generator’s generating unit**); or
 - (c) any other risk specified in the **dispatch objective**.
- (3) The modelling system must calculate the total amount of **fast instantaneous reserve** and **sustained instantaneous reserve** required to meet the requirements of the **dispatch objective**. The amount of **fast instantaneous reserve** and **sustained instantaneous reserve** to be provided by each **ancillary service agent** is this amount less any **instantaneous reserve** being provided by any other person who is not an **ancillary service agent** (as advised by the **system operator**).
- (4) The modelling system must not schedule **instantaneous reserve** at a **generating unit** or **generating station** that would result in the scheduled quantity of **electricity** to be generated plus the scheduled quantity of **instantaneous reserve** to be provided that is greater than the maximum **generator** effective reserve capacity of that **generating unit** or **generating station** as specified in the **reserve offer** for that **generating unit** or **generating station**.
- (5) The modelling system must use the price and quantity values set out in the table in clause 13.58AA(3) for the following model parameters:
 - (a) **fast instantaneous reserve** contingent event risk violation;
 - (b) **sustained instantaneous reserve** contingent event risk violation.

Compare: Electricity Governance Rules 2003 clause 3.4 schedule G6 part G
Clause 12(2)(b): amended, on 21 September 2012, by clause 32(2) of the Electricity Industry Participation (Minor Amendments) Code Amendment 2012.
Clause 12 Heading: amended, on 15 May 2014, by clause 78 of the Electricity Industry Participation (Modified Dispatchable Demand) Code Amendment 2013.
Clause 12(3): amended, on 5 October 2017, by clause 485 of the Electricity Industry Participation Code Amendment (Code Review Programme) 2017.
Clause 12(5): inserted, on 1 November 2022, by clause 170 of the Electricity Industry Participation Code Amendment (Real Time Pricing) 2022.

- 13 Adjustments to schedules to meet dispatch objective**(1) As soon as practicable after each **price-responsive schedule** and **non-response schedule** has been completed and each **dispatch schedule** has been implemented, the **system operator** must give notice on **WITS** to **participants** of any adjustments required to the **price-responsive schedule, non-response schedule** or **dispatch schedule** (as the case may be) to meet the **dispatch objective**, including adjustments for—
- (a) **voltage support**; and
 - (b) **frequency keeping** reserves; and
 - (c) over-frequency arming; and
 - (d) additional transmission **constraints**; and
 - (e) **instantaneous reserve**.
- (2) The adjustments identified in subclause (1) must be made by setting 1 or a combination of the following parameters:
- (a) minimum generation (in **MW**) required at a **grid injection point** or group of **grid exit points**;
 - (b) maximum generation (in **MW**) required at a **grid injection point** or group of **grid exit points**;
 - (c) minimum flow limits (in **MW**) on a transmission line or a transformer;
 - (d) maximum flow limits (in **MW**) on a transmission line or a transformer;
 - (e) minimum flow limits (in **MW**) on a group of transmission **lines** or transformers;
 - (f) maximum flow limits (in **MW**) on a group of transmission **lines** or transformers;
 - (g) the reserve modelling parameters as contained in Form 7 in Schedule 13.1.
- (3) *[Revoked]*
- (4) *[Revoked]*

Compare: Electricity Governance Rules 2003 clauses 4.1 and 4.2 schedule G6 part G
Clause 13 Heading: substituted, on 28 June 2012, by clause 63(1) of the Electricity Industry Participation (Demand-side Bidding and Forecasting) Code Amendment 2011.
Clause 13(1): amended, on 5 October 2017, by clause 486 of the Electricity Industry Participation Code Amendment (Code Review Programme) 2017.
Clauses 13(1), (3) and (4): substituted, on 28 June 2012, by clause 63(2) of the Electricity Industry Participation (Demand-side Bidding and Forecasting) Code Amendment 2011.
Clause 13(1): amended, on 1 November 2022, by clause 171(1) of the Electricity Industry Participation Code Amendment (Real Time Pricing) 2022.
Clause 13(2)(e) and (f): amended, on 1 February 2016, by clause 89 of the Electricity Industry Participation Code Amendment (Code Review Programme) 2015.
Clause 13(3) and (4): revoked, on 1 November 2022, by clause 171(2) of the Electricity Industry Participation Code Amendment (Real Time Pricing) 2022.

14 Principles to be followed by system operator

In suggesting changes and making adjustments under clause 13, the **system operator** must have regard to the following principles:

- (a) constraints must be imposed on **generating plant** only if the **system operator** has a specific requirement from the **generating plant** to meet the requirements of the **dispatch objective**:
- (b) constraints must be imposed on a transmission line or transformer only if the **system operator** has a specific requirement from the line or the transformer to meet the requirements of the **dispatch objective**:
- (c) adjustments must be made to **instantaneous reserve** modelling parameters only if the **system operator** has a specific requirement for **instantaneous reserve** to meet the requirements of the **dispatch objective**.

Compare: Electricity Governance Rules 2003 clause 4.3 schedule G6 part G
Clause 14(b): amended, on 28 June 2012, by clause 64 of the Electricity Industry Participation (Demand-side Bidding and Forecasting) Code Amendment 2011.

15 *[Revoked]*

Compare: Electricity Governance Rules 2003 clause 5 schedule G6 part G
Clause 15: amended, on 28 June 2012, by clause 65 of the Electricity Industry Participation (Demand-side Bidding and Forecasting) Code Amendment 2011.
Clause 15(aa): inserted, on 15 May 2014, by clause 79(a) of the Electricity Industry Participation (Modified Dispatchable Demand) Code Amendment 2013.
Clause 15(d)(i) and (iii): amended, on 20 December 2021, by clause 62 of the Electricity Industry Participation Code Amendment (Code Review Programme) 2019.
Clause 15(d)(ii): substituted, on 1 November 2012, by clause 6(2) of the Electricity Industry Participation (HVDC Link Pole 3 Standing Data) Code Amendment 2012.
Clause 15(e): amended, on 15 May 2014, by clause 79(b) of the Electricity Industry Participation (Modified Dispatchable Demand) Code Amendment 2013.
Clause 15: revoked, on 1 November 2022, by clause 172 of the Electricity Industry Participation Code Amendment (Real Time Pricing) 2022.

16 Calculation of prices, marginal location factors and reserve prices

- (1) The modelling system must calculate the following set of prices:
 - (a) prices for **electricity** at each **grid injection point** and **grid exit point**, and at each **reference point**:
 - (b) **reserve prices** for each **island**:
 - (c) **marginal location factors** for each **grid injection point** and each **grid exit point**. Those factors must be determined by dividing the price at that **grid injection point** or **grid exit point** by the price at the **reference point** relevant to that **grid injection point** or **grid exit point**.
- (2) The modelling system must assign—
 - (a) a price for **electricity** at each **grid injection point** and **grid exit point** that is **electrically disconnected** in the modelling system; and
 - (b) a 0 price for **electricity** at each **grid injection point** and **grid exit point** that is subject to a surplus bus generation infeasibility.”
- (3) The prices described in subclause (1) must be used—
 - (a) for a **price-responsive schedule** or a **non-response schedule**, as—
 - (i) **forecast prices**; and
 - (ii) **forecast reserve prices**:
 - (b) for a **dispatch schedule** or for preparing the information referred to in Schedule 13.3B as—
 - (i) **dispatch prices**; and
 - (ii) **dispatch reserve prices**.

Compare: Electricity Governance Rules 2003 clauses 6 to 6.2 schedule G6 part G

Clause 16(3): amended, on 28 June 2012, by clause 66 of the Electricity Industry Participation (Demand-side Bidding and Forecasting) Code Amendment 2011.

Clause 16(c): revoked, on 28 June 2012, by clause 66(d) of the Electricity Industry Participation (Demand-side Bidding and Forecasting) Code Amendment 2011.

Clause 16(1)(a): amended, on 21 September 2012, by clause 32(3) of the Electricity Industry Participation (Minor Amendments) Code Amendment 2012.

Clause 16(2): amended, on 5 October 2017, by clause 487 of the Electricity Industry Participation Code Amendment (Code Review Programme) 2017.

Clause 16(2): amended, on 1 November 2022, by clause 173(1) of the Electricity Industry Participation Code Amendment (Real Time Pricing) 2022.

Clause 16(3): amended, on 1 November 2022, by clause 173(2) of the Electricity Industry Participation Code Amendment (Real Time Pricing) 2022.

17 What modelling system must take into account when calculating prices

The modelling system must calculate the prices in clause 16 consistent with the objective function, and consistent with the quantities of **electricity** and **instantaneous reserve** scheduled, while meeting all constraints, and in particular—

- (a) prices for **electricity** at each **grid injection point** or **grid exit point** must be consistent with the treatment of transmission system **losses** and the transmission system power flow; and
- (b) subject to the rights of the **system operator** described in clause 13, a **generator** at a **grid injection point** must be scheduled to generate a quantity of **electricity** from a price band if the price determined by the modelling system at the **reference point** multiplied by the marginal location factor at that **grid injection point** is greater than or equal to the price offered in that price band; and
- (c) subject to the rights of the **system operator** described in clause 13, a **generator** at a **grid injection point** must not be scheduled to generate a quantity of **electricity** from a price band if the price determined by the modelling system at the **reference point** multiplied by the relevant marginal location factor at that **grid injection point** is less than the price offered in that price band; and
- (d) for **nominated bids**, subject to the obligations of the **system operator** described in clause 13, a **purchaser** at a **grid exit point**—
 - (i) must be scheduled to purchase a quantity of **electricity** from a price band if the price determined by the modelling system at the **reference point** multiplied by the relevant marginal location factor at the **grid exit point** is less than the price bid for the price band; and
 - (ii) must not be scheduled to purchase a quantity of **electricity** from a price band if the price determined by the modelling system at the **reference point** multiplied by the relevant marginal location factor at the **grid exit point** is greater than the price bid for the price band; and
 - (iii) where the **system operator** has agreed to model a **nominated dispatch bid** for a **dispatch-capable load station** as a **binary load**, must only be scheduled to purchase the full quantity of **MW** specified in a price band in the **nominated dispatch bid** (and not a quantity of **electricity** that corresponds to only part of the **MW** specified in a price band in the **nominated dispatch bid**) or 0 **MW**. This subparagraph applies despite anything in subparagraphs (i) and (ii); and
- (e) for positive **difference bids**, subject to the obligations of the **system operator** described in clause 13, a **purchaser** at a **grid exit point**—

- (i) must be scheduled to increase a quantity of **electricity** if the price determined by the modelling system at the **reference point** multiplied by the relevant marginal location factor at the **grid exit point** is less than the price bid for the price band; and
 - (ii) must not be scheduled to increase a quantity of **electricity** if the price determined by the modelling system at the **reference point** multiplied by the relevant marginal location factor at the **grid exit point** is greater than the price bid for the price band; and
- (ea) for negative **difference bids**, subject to the obligations of the **system operator** described in clause 13, a **purchaser** at a **grid exit point**—
 - (i) must be scheduled to decrease a quantity of **electricity** if the price determined by the modelling system at the **reference point** multiplied by the relevant marginal location factor at that **grid exit point** is greater than the price bid for the price band; and
 - (ii) must not be scheduled to decrease a quantity of **electricity** if the price determined by the modelling system at the **reference point** multiplied by the relevant marginal location factor at that **grid exit point** is less than the price bid for the price band; and
- (eb) subject to the obligations of the **system operator** described in clause 13, a **purchaser** at a **conforming GXP** that does not submit a **difference bid** in relation to the **GXP**—
 - (i) must be scheduled to purchase a quantity of **electricity** from a price band if the price determined by the modelling system at the **reference point** multiplied by the relevant marginal location factor at the **grid exit point** is less than the relevant scarcity price band as described in clause 13.58AA(3); and
 - (ii) must not be scheduled to purchase a quantity of **electricity** from a price band if the price determined by the modelling system at the **reference point** multiplied by the relevant marginal location factor at the **grid exit point** is greater than the relevant scarcity price band as described in clause 13.58AA(3); and
- (f) subject to the rights of the **system operator** described in clause 13, an **ancillary service agent** who has made a **reserve offer** must be scheduled to provide a quantity of **instantaneous reserve** from a reserve price band only if the reserve price determined by the modelling system is greater than or equal to the total price offered for that reserve price band. In the case of a **reserve offer** for a **generating unit**, the total price offered for a price band must be equal to the amount required to ensure that that **ancillary service agent** is indifferent as to whether it generates **electricity** or provides **instantaneous reserve** plus the price **offered** in that reserve price band; and
- (g) subject to the rights of the **system operator** described in clause 13, an **ancillary service agent** who has made a **reserve offer** must not be scheduled to provide a quantity of **instantaneous reserve** from a price band if the reserve price determined by the modelling system is less than the total price offered for that price band. In the case of a **reserve offer** for a **generating unit**, the total price offered for a price band is equal to the amount required to ensure that that

ancillary service agent is indifferent as to whether it generates **electricity** or provides **instantaneous reserve** plus the price offered in that reserve price band.

Compare: Electricity Governance Rules 2003 clause 6.3 schedule G6 part G

Clause 17(d) and (e): substituted, on 28 June 2012, by clause 66A(a) and (b) of the Electricity Industry Participation (Demand-side Bidding and Forecasting) Code Amendment 2011.

Clause 17(ea): inserted, on 28 June 2012, by clause 66A(c) of the Electricity Industry Participation (Demand-side Bidding and Forecasting) Code Amendment 2011.

Clause 17(d)(iii): inserted, on 1 November 2022, by clause 174(1) of the Electricity Industry Participation Code Amendment (Real Time Pricing) 2022.

Clause 17(eb): inserted, on 1 November 2022, by clause 174(2) of the Electricity Industry Participation Code Amendment (Real Time Pricing) 2022.

Clause 17(b) and (c): amended, on 1 March 2024, by clause 88 of the Electricity Industry Participation Code Amendment (Code Review Programme) 2024.

cl 13.135B

Schedule 13.3A
**Calculation of interim prices and interim reserve prices in
scarcity pricing situation**

[Revoked]

Schedule 13.3A: inserted, on 1 June 2013, by clause 17 of the Electricity Industry Participation (Scarcity Pricing) Code Amendment 2011.

Schedule 13.3A: revoked, on 1 November 2022, by clause 175 of the Electricity Industry Participation Code Amendment (Real Time Pricing) 2022.

Schedule 13.3AA

cls 13.69AA and 13.69B

Managing an unsupplied demand situation in the dispatch schedule

Schedule 13.3AA: inserted, on 1 November 2022, by clause 176 of the Electricity Industry Participation Code Amendment (Real Time Pricing) 2022.

1 Contents of this Schedule

This Schedule sets out the processes by which the **system operator**—

- (a) assigns price and quantity values as specified in clause 13.69AA:
- (b) adjusts the expected profile of **demand** in accordance with clause 13.69B(1)(d)(i) used in the preparation of the **dispatch schedule** under clause 13.69A.

2 Calculating unsupplied demand quantity and price values

- (1) For each **dispatch schedule** prepared under clause 13.69A, the **system operator** must assign the price and quantity values specified by clause 13.69AA to all non-dispatchable **demand** according to the methodology in subclause (3).
- (2) The methodology in subclause (3) applies at each **GXP** that is—
 - (a) not the subject of a **nominated dispatch bid**; and
 - (b) subject to a **nominated non-dispatch bid**.
- (3) The methodology for calculating the quantity of **demand** for each price tranche is—

$$\text{demand}(t) = \text{demand}(GXP) \times \text{fraction}(T)$$

where

demand(t) is the **demand** for one of the tranches specified by clause 13.58AA(2)

demand(GXP) is the total non-dispatchable **demand** at the **GXP**

fraction(T) is the percentage of the relevant **demand** tranche specified by clause 13.58AA(2).

3 Adjusting expected profile of demand for demand that was unable to be supplied

- (1) As soon as practicable after the **system operator** instructs the **electrical disconnection** of **demand** in accordance with Schedule 8.3, Technical Code B, clause 6(1)(d) or 6(2)(d), the **system operator** must—
 - (a) calculate and record the **demand** limit for each relevant **GXP**; and
 - (b) record the Short-Term Load Forecast values for the relevant load forecast regions for all available 5-minute market intervals in the future, being the linear interpolation across time of the load forecast prepared under clause 13.7A.
- (2) After the **system operator** has instructed the **electrical disconnection** of **demand** described in subclause (1), the expected profile of **demand** used in the **dispatch schedule**, for the purposes of calculating **dispatch prices**, is—

$$\text{expected profile of demand}(GXP) = \text{current GXP demand} + \text{unsupplied demand}(GXP)$$

where

current GXP demand is the **demand** measured according to the information provided by the **grid owner** under clause 13.69AAA, or an appropriate substitute where information under clause 13.69AAA is unavailable

unsupplied demand (GXP) is the quantity calculated in subclause (3).

- (3) The **system operator** must apply the following calculation to determine the quantity of **demand** that was unable to be supplied for the market interval ‘i’:

$$\text{unsupplied demand (GXP, i)} = \text{predicted demand (GXP, i)} - \text{demand limit (GXP, i)}$$

where

predicted demand (GXP, i) is the quantity calculated in subclause (4)

demand limit (GXP, i) is the limit recorded under subclause (1).

- (4) The predicted demand referred to in subclause (3) is the amount of **demand** that was expected to be present at a given **conforming GXP** in interval ‘i’ absent the instruction to **electrically disconnect demand** referred to in subclause (1), estimated at the time of the instruction referred to in subclause (1), calculated as follows:

$$\text{predicted demand (GXP, i)} = \text{current GXP demand} \times [\text{STLF}(i) / \text{STLF}(0)]$$

where

current GXP demand is the amount of **demand** at a given **GXP** at the time of the recording of the instruction referred to in subclause (1), determined according to the **system operator’s** methodology made available under the **policy statement**

market interval ‘i’ is the period of time of 5-minute duration for which the relevant **dispatch schedule** is calculating the expected profile of **demand**

STLF(i) is the Short-Term Load Forecast value for the relevant load forecast region in which the **GXP** is located, for market interval ‘i’

STLF(0) is the Short-Term Load Forecast for the relevant load forecast region in which the **GXP** is located, for the market interval in which the instruction referred to in subclause (1) was recorded

in the case of a **GXP** which is subject to a **nominated non-dispatch bid**, $[\text{STLF}(i) / \text{STLF}(0)] = 1$.

Schedule 13.3B

cls 13.59, 13.69C, 13.104 and 13.104A

Information for schedules prepared by system operator

Schedule 13.3B: inserted, on 1 November 2022, by clause 177 of the Electricity Industry Participation Code Amendment (Real Time Pricing) 2022.

1 Purpose of this schedule

- (1) This Schedule sets out the information required to be contained in, and/or published by, the **dispatch schedule**, **price-responsive schedule** and **non-response schedule**.
- (2) Contents of schedules, columns 1, 2, and 3, are those values derived by the modelling system using the input information listed in clause 13.69B for the **dispatch schedule** and clause 13.58A for the **price-responsive schedule** and **non-response schedule**.
- (3) Published information, columns 4, 5, and 6, are those values that are required to be transmitted by the **system operator** to the **WITS manager** for public consumption at the time the schedules are published.

		1	2	3	4	5	6
Information required		Contents of schedules			To be published		
Row	Schedule	PRS	NRS	Dispatch	PRS	NRS	Dispatch
1	scheduled average level of electricity output for each generating plant or generating unit	X	X				
2	scheduled level of electricity output for each generating plant or generating unit			X			
3	scheduled average level of instantaneous reserve for each generating plant or generating unit	X	X				
4	scheduled level of instantaneous reserve for each generating plant or generating unit			X			
5	scheduled average level of interruptible load for each ancillary service agent for each grid exit point or interruptible load group grid exit point	X	X				

Electricity Industry Participation Code 2010
Schedule 13.3B

		1	2	3	4	5	6
Information required		Contents of schedules			To be published		
Row	Schedule	PRS	NRS	Dispatch	PRS	NRS	Dispatch
6	scheduled level of interruptible load for each ancillary service agent for each grid exit point or interruptible load group grid exit point			X			
7	scheduled frequency keeping units for each island	X	X			X	
8	expected average level of demand at each grid exit point	X	X		X	X	
9	expected level of demand at each grid exit point			X			X
10	forecast prices	X	X		X	X	
11	dispatch prices			X			X
12	forecast reserve prices	X	X		X	X	
13	dispatch reserve prices			X			X
14	start time (to the nearest second) for each dispatch price and each dispatch reserve price						X
15	forecast marginal location factors for each grid injection point and each grid exit point	X	X		X	X	
16	dispatch marginal location factors for each grid injection point and each grid exit point			X			X
17	scheduled largest single reserve risk in each island	X	X	X	X	X	X
18	scheduled number of reserve risks for each island	X	X	X	X	X	X
19	for each island , the scheduled number of reserve risks	X	X	X	X	X	X

Electricity Industry Participation Code 2010
Schedule 13.3B

		1	2	3	4	5	6
Information required		Contents of schedules			To be published		
Row	Schedule	PRS	NRS	Dispatch	PRS	NRS	Dispatch
	subject to the fast instantaneous reserve contingent event risk violation and sustained instantaneous reserve contingent event risk violation model parameters set out in Schedule 13.2						
20	scheduled level of fast instantaneous reserve and sustained instantaneous reserve in each island	X	X	X	X	X	X
21	separate stacks of reserve offers for fast instantaneous reserve and sustained instantaneous reserve for each island (ranking in price order from lowest to highest)	X	X	X	X	X	X
22	separate stacks of all reserve offers for fast instantaneous reserve and sustained instantaneous reserve for each island (ranking in price order from lowest to highest) adjusted for the expected level of energy output for each generating plant or generating unit	X	X	X	X	X	X
23	scheduled HVDC component flows	X	X	X	X	X	X
24	scheduled HVDC risk offsets	X	X	X	X	X	X
25	expected near-constraint arc flows	X	X	X	X	X	X
26	expected near-group-constraint arc flows	X	X	X	X	X	X
27	group constraint formulas relating to the expected near-group-constraint arc flows	X	X	X	X	X	X

Electricity Industry Participation Code 2010
Schedule 13.3B

		1	2	3	4	5	6
Information required		Contents of schedules			To be published		
Row	Schedule	PRS	NRS	Dispatch	PRS	NRS	Dispatch
28	scheduled deficit quantities for energy, fast instantaneous reserve , and sustained instantaneous reserve (if any)	X	X	X	X	X	X
29	whether the HVDC link is out of service	X	X	X	X	X	X
30	quantity of demand for which price and quantity values have been assigned by the system operator under clause 13.58AA(1)(a)	X					
31	quantity of demand for which price and quantity values have been assigned by the system operator under clause 13.58AA(1)(b)		X				
32	quantity of demand for which price and quantity values have been assigned by the system operator under clause 13.69AA(1)(a)			X			
33	quantities for each bid scheduled to be supplied	X					
34	expected non-dispatch-capable load at each conforming GXP		X				
35	expected demand for each nominated bid		X				
36	quantities for each nominated dispatch bid scheduled to be supplied			X			
37	in the case of an unsupplied demand situation , the demand (in MW) unable to be supplied at each grid exit point	X	X	X	X	X	X
38	aggregate supply curve at each reference point				X	X	

Electricity Industry Participation Code 2010
Schedule 13.3B

		1	2	3	4	5	6
Information required		Contents of schedules			To be published		
Row	Schedule	PRS	NRS	Dispatch	PRS	NRS	Dispatch
	incorporating all offers from generators with offer prices adjusted for forecast marginal location factors , and adjusted so that, for each intermittent generating station , the total offered quantity is no greater than the forecast of generation potential for that intermittent generating station , being the forecast of generation potential used as an input into the price-responsive schedule or the non-response schedule (whichever applies)						
39	aggregate supply curve at each reference point incorporating all offers from generators with offer prices adjusted for dispatch marginal location factors						X
40	grid injection points and grid exit points that are electrically disconnected in the modelling system				X	X	X
41	aggregate demand curve at each reference point incorporating the forecast prepared under clause 13.7A(1), and all bids from purchasers with bid prices adjusted for forecast marginal location factors				X		
42	aggregate demand curve at each reference point incorporating the expected profile of demand , and all nominated dispatch bids with bid prices adjusted for						X

Electricity Industry Participation Code 2010
Schedule 13.3B

		1	2	3	4	5	6
Information required		Contents of schedules			To be published		
Row	Schedule	PRS	NRS	Dispatch	PRS	NRS	Dispatch
	dispatch marginal location factors						
43	number of transmission lines or transformers that have a MW arc flow equal to the maximum flow limit (in MW) on that transmission line or transformer set by the grid owner in accordance with clauses 13.29 to 13.32						X
44	number of groups of transmission lines or transformers, or both, that have a total MW arc flow equal to the relevant maximum flow limit (in MW) as set by the system operator in accordance with Schedule 13.3						X
45	aggregate of the following: (i) the number of occurrences at which energy (in MW) for a generator at a set of grid injection points is equal to the minimum and/or maximum generation (in MW) for that set of grid injection points set by the system operator in accordance with Schedule 13.3: (ii) the number of occurrences at which energy (in MW) and reserves (in MW) for a generator at a set of grid injection points is equal to the maximum						X

Electricity Industry Participation Code 2010
Schedule 13.3B

		1	2	3	4	5	6
Information required		Contents of schedules			To be published		
Row	Schedule	PRS	NRS	Dispatch	PRS	NRS	Dispatch
	<p>generation (in MW) for that set of grid injection points set by the system operator in accordance with Schedule 13.3:</p> <p>(iii) the number of occurrences at which reserve (in MW) for a participant at a set of grid exit points is equal to the maximum reserve (in MW) for that set of grid exit points as determined under Schedule 13.3</p>						
46	number of occurrences at which the ramp up rate is equal to the maximum ramp up rate specified in the relevant offer						X
47	number of occurrences at which the ramp down rate is equal to the maximum ramp down rate specified in the relevant offer						X

Schedule 13.4

cl 13.3

Approval as type A or type B industrial co-generating station

Heading: amended, on 27 May 2015, by clause 18 of the Electricity Industry Participation Code Amendment (Industrial Co-generation Dispatch Arrangements) 2015.

1 Generators to apply to Authority for approval

A **generator** may apply to the **Authority** to have 1 or more **generating units** approved as—

- (a) a **type A industrial co-generating station**; or
- (b) a **type B industrial co-generating station**.

Compare: Electricity Governance Rules 2003 clause 1 schedule G9 part G

Clause 1: substituted, on 27 May 2015, by clause 19 of the Electricity Industry Participation Code Amendment (Industrial Co-generation Dispatch Arrangements) 2015.

2 Application requirements

(1) An application must—

- (a) be in writing; and
- (b) specify each **generating unit** that the applicant wants to have approved; and
- (c) include information related to any seasonal operation of each **generating unit**; and
- (d) specify whether the applicant wants each **generating unit** to be approved as a—
 - (i) **type A industrial co-generating station**; or
 - (ii) **type B industrial co-generating station**.

(2) An applicant may include any supporting information that the applicant considers may assist the **Authority** with the application.

Compare: Electricity Governance Rules 2003 clause 2 schedule G9 part G

Clause 2: substituted, on 27 May 2015, by clause 20 of the Electricity Industry Participation Code Amendment (Industrial Co-generation Dispatch Arrangements) 2015.

3 Authority must publish each application for approval

On receipt of an application, the **Authority** must—

- (a) **publish** the application; and
- (b) provide a copy of the application to the **system operator**.

Compare: Electricity Governance Rules 2003 clause 3 schedule G9 part G

Clause 3 Heading: amended, on 5 October 2017, by clause 488(1) of the Electricity Industry Participation Code Amendment (Code Review Programme) 2017.

Clause 3(a): amended, on 5 October 2017, by clause 488(2) of the Electricity Industry Participation Code Amendment (Code Review Programme) 2017.

4 Factors that Authority must consider

Before the **Authority** approves an application, it must take into account—

- (a) the **system operator's** views as to the effect an approval would have on the **system operator's** ability to meet the **PPOs**; and
- (b) the cumulative effects, if the approval were granted, of all approvals granted under this Schedule on the **system operator's** ability to meet the **PPOs**; and
- (c) any views that may be made known to the **Authority** within the time specified by the **Authority** when it **published** the application in accordance with clause 3(a); and
- (d) whether each **generating unit** that is the subject of the application is as described

in paragraphs (b) and (c) of the definition of **industrial co-generating station** set out in Part 1; and

- (da) the implications of each **generating unit** that is the subject of the application being approved in accordance with the applicant's preference specified under clause 2(1)(d), having regard to the obligations of **type A co-generators** and **type B co-generators**; and
- (e) the **Authority's** main objective in section 15 of the **Act**.

Compare: Electricity Governance Rules 2003 clause 4 schedule G9 part G

Clause 4: amended, on 27 May 2015, by clause 21(1) of the Electricity Industry Participation Code Amendment (Industrial Co-generation Dispatch Arrangements) 2015.

Clause 4(c): amended, on 5 October 2017, by clause 489 of the Electricity Industry Participation Code Amendment (Code Review Programme) 2017.

Clause 4(d): substituted, on 27 May 2015, by clause 21(2) of the Electricity Industry Participation Code Amendment (Industrial Co-generation Dispatch Arrangements) 2015.

Clause 4(da): inserted, on 27 May 2015, by clause 21(2) of the Electricity Industry Participation Code Amendment (Industrial Co-generation Dispatch Arrangements) 2015.

Clause 4(e): amended, on 1 March 2024, by clause 89 of the Electricity Industry Participation Code Amendment (Code Review Programme) 2024.

5 Authority may require extra information

The **Authority** may require the provision of additional information at any stage during the application process and, if the **Authority's** requirements are reasonable, the applicant must provide that information to the **Authority**.

Compare: Electricity Governance Rules 2003 clause 5 schedule G9 part G

6 Authority may seek independent expert advice

In considering an application for approval, the **Authority** may seek technical advice from an independent person who is familiar with co-generation.

Compare: Electricity Governance Rules 2003 clause 6 schedule G9 part G

7 Applicant may withdraw or amend application at any time

- (1) The applicant may, at any time, withdraw or amend an application being considered by the **Authority**.
- (2) An amendment or withdrawal—
 - (a) must be made in writing; and
 - (b) must be submitted to the **Authority**; and
 - (c) takes effect from the date of receipt by the **Authority**.

Compare: Electricity Governance Rules 2003 clause 7 schedule G9 part G

Clause 7(1): amended, on 27 May 2015, by clause 22(1) of the Electricity Industry Participation Code Amendment (Industrial Co-generation Dispatch Arrangements) 2015.

Clause 7(2): inserted, on 27 May 2015, by clause 22(2) of the Electricity Industry Participation Code Amendment (Industrial Co-generation Dispatch Arrangements) 2015.

8 Authority's decision

- (1) The **Authority** must, no later than 6 months after receiving an application,—
 - (a) approve each **generating unit** that is the subject of the application as either—
 - (i) a **type A industrial co-generating station**; or
 - (ii) a **type B industrial co-generating station**; or
 - (b) decline to approve the application.
- (2) The **Authority** must consult with an applicant before making a decision if the

Authority—

- (a) proposes to approve an application for a type of **industrial co-generating station** other than the applicant's preference specified under clause 2(1)(d); or
 - (b) proposes to decline the application.
- (3) The **Authority** must, as soon as practicable after making a decision,—
- (a) advise the applicant, the **system operator**, the **grid owner**, and the **clearing manager** in writing; and
 - (b) **publish** its decision, including—
 - (i) the reasons for the decision; and
 - (ii) in the case of an application that has been approved, any conditions that have been imposed.

Compare: Electricity Governance Rules 2003 clause 8 schedule G9 part G

Clause 8: substituted, on 27 May 2015, by clause 23 of the Electricity Industry Participation Code Amendment (Industrial Co-generation Dispatch Arrangements) 2015.

Clause 8(3)(b): amended, on 5 October 2017, by clause 490 of the Electricity Industry Participation Code Amendment (Code Review Programme) 2017.

9 Decision must be recorded

- (1) The **Authority** must keep a register of all current approvals granted under this Schedule available for public inspection free of charge during normal office hours at the offices of the **Authority** and on the **Authority's** website at all reasonable times.
- (2) The register must state, for each approval on the register,—
 - (a) whether the applicant's **generating units** have been approved as a **type A co-generating station** or a **type B co-generating station**; and
 - (b) the name of the **type A co-generator** or the **type B co-generator**; and
 - (c) the name of the **type A industrial co-generating station** or the **type B industrial co-generating station**; and
 - (d) the date of the approval; and
 - (e) the duration of the approval; and
 - (f) whether the approval includes any conditions and if so, a description of the conditions.

Compare: Electricity Governance Rules 2003 clause 9 schedule G9 part G

Clause 9(2): substituted, on 27 May 2015, by clause 24 of the Electricity Industry Participation Code Amendment (Industrial Co-generation Dispatch Arrangements) 2015.

10 Effect of approval

Approval of 1 or more **generating units** as a **type A industrial co-generating station** or a **type B industrial co-generating station** takes effect from the date specified in the approval, which may be no earlier than **10 business days** after the date of the notice of decision **published** by the **Authority** under clause 8(3).

Compare: Electricity Governance Rules 2003 clause 10 schedule G9 part G

Clause 10: substituted, on 27 May 2015, by clause 25 of the Electricity Industry Participation Code Amendment (Industrial Co-generation Dispatch Arrangements) 2015.

Clause 10: amended, on 5 October 2017, by clause 491 of the Electricity Industry Participation Code Amendment (Code Review Programme) 2017.

11 Authority may impose conditions

The **Authority** may impose conditions on any approval it grants. Such conditions may include 1 or more of the following:

- (a) requirements to assist the **system operator** in meeting the **PPOs**:

- (b) requirements as to seasonal co-generation, including limitations on when the approval applies:
- (c) requirements that a **type A co-generator** or **type B co-generator** comply with specific instructions from the **system operator** during a **grid emergency** or during a **system constraint** that directly affects the **type A co-generator** or **type B co-generator**.

Compare: Electricity Governance Rules 2003 clause 11 schedule G9 part G

Clause 11(b) and (c): substituted, on 27 May 2015, by clause 26 of the Electricity Industry Participation Code Amendment (Industrial Co-generation Dispatch Arrangements) 2015.

12 *[Revoked]*

Compare: Electricity Governance Rules 2003 clause 12 schedule G9 part G

Clause 12: revoked, on 27 May 2015, by clause 27 of the Electricity Industry Participation Code Amendment (Industrial Co-generation Dispatch Arrangements) 2015.

13 **Authority may rescind or amend approval**

- (1) If the **Authority** considers a change of circumstance has led to a situation in which the continuation of an approval would significantly adversely impact on the **system operator's** ability to meet the **PPOs**, it may amend or rescind the approval.
- (2) The **Authority** may, at the request of a **type A co-generator** or a **type B co-generator**, amend an approval to change a **type A industrial co-generating station** to a **type B co-generating station**, or vice-versa.
- (3) The **Authority** must consult with the **system operator** before amending an approval under subclause (2).

Compare: Electricity Governance Rules 2003 clause 13 schedule G9 part G

Clause 13(2) and (3): inserted, on 27 May 2015, by clause 28 of the Electricity Industry Participation Code Amendment (Industrial Co-generation Dispatch Arrangements) 2015.

14 **Notice and reasons for rescinding or amending approval**

If the **Authority** amends or rescinds an approval, it must—

- (a) give the **type A co-generator** or **type B co-generator** 3 months' notice before rescinding or amending the approval; and
- (b) advise the **type A co-generator** or **type B co-generator** of the reasons for rescinding or amending the approval.

Compare: Electricity Governance Rules 2003 clause 14 schedule G9 part G

Clause 14(a) and (b): substituted, on 27 May 2015, by clause 29 of the Electricity Industry Participation Code Amendment (Industrial Co-generation Dispatch Arrangements) 2015.

Schedule 13.5

cl 13.238

Requirements for FTR allocation plan

Schedule 13.5: inserted, on 1 October 2011, by clause 9 of the Electricity Industry Participation (Financial Transmission Rights) Code Amendment 2011.

1 Purpose

The purpose of this Schedule is to set out the requirements for the **FTR allocation plan** prepared by the **FTR manager** under subpart 6 of Part 13.

2 Requirements for design of FTRs

- (1) **FTRs** must be allocated by auction.
- (2) At a minimum, the **FTRs** allocated under the **FTR allocation plan** must be **FTRs** between a **hub** in the South Island and a **hub** in the North Island that would provide a reasonable match with the trading points for exchange-traded futures products or the equivalent **electricity** futures products, and which would enable the volumes of **FTRs** available to reflect inter-island grid capacity.
- (3) The **FTR manager** must offer **option FTRs** and **obligation FTRs**.
- (4) The **FTRs** offered must include **FTRs** for which the **FTR period** is 1 month.
- (5) Subclause (4) does not prevent the **FTR manager** from offering **FTRs** relating to a shorter **FTR period** in addition to **FTRs** for which the **FTR period** is 1 month.

3 Requirements for FTR auction design

- (1) The number and nature of the **FTRs** allocated under the **FTR allocation plan** and available for auction must be—
 - (a) supported by a reasonable estimate of the capacity of the **grid** for the relevant period; and
 - (b) set so as to achieve a reasonable balance between the following:
 - (i) ensuring that there is revenue available that is sufficient to settle the **FTRs**;
 - (ii) ensuring that sufficient **FTRs** are available so that **participants** who wish to purchase **FTRs** are able to obtain them.
- (2) The **FTR auction** must be designed to—
 - (a) maximise the value of trade in the auction as determined by the bids made in the auction; and
 - (b) maximise competition in the auction; and
 - (c) minimise costs of participation in the auction.
- (3) The **FTR allocation plan** must include **FTR auction** procedures.
- (4) The initial **FTR allocation plan** must specify a plan that seeks to—
 - (a) ensure that, no later than 1 year after the first **FTR auction**, **FTRs** are available in each **FTR auction** relating to an initial month and to at least each of the 11 months following the initial month; and
 - (b) ensure that the availability of **FTRs** is progressively increased so that, no later than 3 years after the first **FTR auction**, **FTRs** are available in each **FTR auction**

relating to an initial month and to at least the 23 months following the initial month.

Clause 3(3): amended, on 5 October 2017, by clause 492 of the Electricity Industry Participation Code Amendment (Code Review Programme) 2017.

4 Requirements for FTR grid design

The **FTR grid** must—

- (a) be based on each **grid owner's** forecast of the configuration and capacity of its **grid** for the **FTR period**; and
- (b) make allowance for relevant planned and unplanned outages in accordance with reasonable transmission operating practice.

Schedule 13.6

cl 13.248

Schedule 13.6: inserted, on 1 October 2011, by clause 9 of the Electricity Industry Participation (Financial Transmission Rights) Code Amendment 2011.

Schedule 13.6: amended, on 1 June 2012, by clause 7 of the Electricity Industry Participation (Removal of Quantity Limit for Financial Transmission Rights) Code Amendment 2012.

Form 1 Assignment of FTR

Date:

FTR registered number:

If part of the FTR is to be assigned, specify the amount of electricity (in MW) to which the assigned part of the FTR relates:

Price*:

Assignor:

Assignee:

* Parties are only required to specify the price if they wish clause 13.249 to apply.

Schedule 13.7

cls 13.27C, 13.27E, 13.27G, and 13.27K

Schedule 13.7: inserted, on 28 March 2012, by clause 67 of the Electricity Industry Participation (Demand-side Bidding and Forecasting) Code Amendment 2011.

Methodology for Determining Conforming and Non-Conforming GXPs

1 Methodology for determining whether GXP is conforming GXP or non-conforming GXP

In making a determination under clause 13.27A or clause 13.27B(4), the **Authority** must use the following method:

- (a) use the input data described in clause 2 to determine the adjusted reconciled **half hour demand** data (in **MW**) for the **GXP** for each **trading period** during the most recent 12 consecutive months for which data is available; and
- (b) using the results from paragraph (a), determine the mean **demand** (in **MW**) for the **GXP** over the most recent 12 consecutive months for which data is available; and
- (c) determine the unpredictability measure for the **GXP** in accordance with clause 3; and
- (d) apply the results from paragraphs (b) and (c) to the table below, to determine whether the **GXP** is either a **conforming GXP** or a **non-conforming GXP**.

Table 1: Determining whether GXP is conforming or non conforming

Category for mean demand (in MW) for a GXP over relevant 12 months (clause 1(b)) (<i>d</i>)	Category for unpredictability measure (clause 1(c)) (<i>p</i>)	Resulting classification of the GXP
Where $d < 10\text{MW}$	For all <i>p</i>	Conforming GXP
Where $10\text{MW} \leq d < 20\text{MW}$	For $p < 0.15$	Conforming GXP
	For $p \geq 0.15$	Non-conforming GXP
Where $20\text{MW} \leq d < 250\text{MW}$	For $p < 0.10$	Conforming GXP
	For $p \geq 0.10$	Non-conforming GXP
Where $d \geq 250\text{MW}$	For all <i>p</i>	Non-conforming GXP

2 Input data

- (1) For the purpose of determining the adjusted reconciled **half hour demand** data for a **GXP** under clause 1(a), the **Authority** must use the following data from the most recent 12 consecutive months for which data is available:
 - (a) reconciled **half hour demand** data for the **GXP** representing purchases of **electricity** at the **GXP** aggregated across all **purchasers** at the **GXP**, and with each **half hour** figure in **MWh** converted to an average **demand** in **MW** over that **half hour**; and
 - (b) information about the impact of **demand** switching on the **GXP**; and

- (c) information from **distributors, purchasers** and the **system operator** about any one-off events that have affected **demand** but which would not be expected to affect **demand** in the future.
- (2) If the **Authority** identifies, under subclause (1)(b), that 2 or more adjacent **GXPs** are significantly affected by **demand** switching, the **Authority** must—
 - (a) combine the **GXPs**' reconciled **half hour demand** data as described in subclause (1)(a) and follow the method set out in clause 1 for the combined **GXPs** as if they were a single **GXP**; or
 - (b) follow such other method of addressing the impact of **demand** switching as the **Authority** may determine is appropriate in the circumstances.
- (3) In applying the methodology under clause 1, the **Authority** must remove one-off events identified under this clause from the input data.
- (4) A one-off event includes, but is not limited to, the following:
 - (a) a transmission outage that has caused a **GXP** to be unable to be supplied with **electricity**;
 - (b) a **consumer** ceasing to consume at a **GXP**, if over the proportion of the relevant 12 month period for which the **consumer** was consuming **electricity**, the reconciled **demand** attributed to the **consumer** (in **MW**) was on average at least 40% of the total **demand** (in **MW**) at the **GXP**.

3 Calculate unpredictability measures

- (1) For the purpose of determining the unpredictability measure of a **GXP** under clause 1(c), the **Authority** must use the following method:
 - (a) the **Authority** must fit an appropriate statistical predictive model as described in subclause (2), to the adjusted reconciled **half hour demand** data (in **MW**) which is produced in accordance with clause 1(a); and
 - (b) the **Authority** must calculate the residuals (in **MW** for each **half hour**) of the statistical predictive model (representing the simulated predictive errors of such a model); and
 - (c) the **Authority** must calculate the unpredictability measure as the ratio of the standard deviation of the residuals calculated under paragraph (b) to the mean **demand** at the **GXP** (calculated under clause 1(b)).
- (2) The statistical predictive model under subclause (1)(a) must achieve the approximate level of predictive accuracy that should be able to be achieved by the **system operator** when preparing the forecast under clause 13.7A several hours in advance in the absence of forecast information from **purchasers** and **electricity** users.
- (3) To avoid doubt, the statistical predictive model may include a variable representing weather forecast information.

Clause 3(2): amended, on 15 May 2014, by clause 80 of the Electricity Industry Participation (Modified Dispatchable Demand) Code Amendment 2013.

4 Data for most recent 12 months unavailable

- (1) If the data required under clauses 1 to 3 is not available for the most recent 12 consecutive months, the **Authority** must use reasonable endeavours to make a

determination in accordance with the methodology set out in this Schedule using the data it has available.

- (2) If the available data is insufficient to enable the **Authority** to make a determination in accordance with subclause (1), the **Authority** must make a determination by—
- (a) using all available data; and
 - (b) using its own reasonable expectations of the future activities at the **GXP**; and
 - (c) taking into account, to the extent practicable, the methodology set out in clauses 1 to 3.

Schedule 13.8 cl 1.1, 13.3A, 13.3B and 13.3E

Approval of dispatch-capable load station

Schedule 13.8: inserted, on 15 May 2014, by clause 81 of the Electricity Industry Participation (Modified Dispatchable Demand) Code Amendment 2013.

Heading: amended, on 1 November 2022, by clause 178 of the Electricity Industry Participation Code Amendment (Real Time Pricing) 2022.

1 Applications for approval

Each application for approval for a **dispatch-capable load station** must—

- (a) be in writing; and
- (b) list the device, devices or group(s) of devices that the applicant wishes to have approved as a **dispatch-capable load station**; and
- (ba) specify whether the applicant intends to operate the device, devices or group(s) of devices as a **dispatch notification purchaser**; and
- (c) include information to enable the **system operator** to determine the application.

Clause 1(ba): inserted, on 1 November 2022, by clause 179 of the Electricity Industry Participation Code Amendment (Real Time Pricing) 2022.

Clause 1(b): amended, on 1 March 2024, by clause 10(1) of the Electricity Industry Participation Code Amendment (Dispatch Notification Enhancement and Clarifications) 2024.

Clause 1(ba): amended, on 1 March 2024, by clause 10(2) of the Electricity Industry Participation Code Amendment (Dispatch Notification Enhancement and Clarifications) 2024.

1A Change to purchaser type

A **dispatchable load purchaser** may, with the approval of the **system operator** provided in accordance with the application process specified in this Schedule, change from operating a **dispatch-capable load station** as a **dispatchable load purchaser** (that is not a **dispatch notification purchaser**) to operating the **dispatch-capable load station** as a **dispatch notification purchaser**, or vice versa.

Clause 1A: inserted, on 1 November 2022, by clause 180 of the Electricity Industry Participation Code Amendment (Real Time Pricing) 2022.

2 System operator to provide application to Authority and advise others of application

On receipt of an application, the **system operator** must—

- (a) provide a copy of the application to the **Authority**; and
- (b) advise the following **participants** that it has received the application:
 - (i) the relevant **grid owner**;
 - (ii) each **distributor** that has a **network** from which a device that comprises or forms part of the proposed **dispatch-capable load station** draws **electricity**;
 - (iii) *[Revoked]*
 - (iv) the **clearing manager**;
 - (v) the **reconciliation manager**;
 - (vi) the **WITS manager**.

Clause 2(b)(ii) substituted, on 1 February 2016, by clause 90 of the Electricity Industry Participation Code Amendment (Code Review Programme) 2015.

Clause 2(b)(vi): amended, on 5 October 2017, by clause 493 of the Electricity Industry Participation Code Amendment (Code Review Programme) 2017.

Clause 2B(iii): revoked, on 1 November 2022, by clause 181 of the Electricity Industry Participation Code Amendment (Real Time Pricing) 2022.

3 Factors that system operator must consider

- (1) Before the **system operator** approves a device or a group of devices to be a **dispatch-capable load station**, it must consider—
 - (aa) where the application is for a **dispatch-capable load station** consisting of devices or a group of devices located at more than one **GXP**, the most appropriate **GXPs** at which **nominated bids** for the **dispatch-capable load station** would be submitted; and
 - (a) the effect an approval would have on the **system operator's** ability to comply with the **PPOs**; and
 - (b) whether the applicant—
 - (i) is able to provide real time indications and measurements to the satisfaction of the **system operator**; and
 - (ii) has in place communication systems that meet the **system operator's** requirements; and
 - (iii) is able to receive **dispatch instructions** or **dispatch notifications** (as the case may be); and
 - (c) whether there is a substantial risk that a **dispatch instruction** or **dispatch notification** (as the case may be) that changes the level of load of the device or group of devices that is the subject of the application may be offset by changes in **demand** in the same **trading period** from other load controlled by the applicant; and
 - (d) whether the device or group of devices is technically capable of complying with a **dispatch instruction** or **dispatch notification** (as the case may be) so that it does not adversely affect the **system operator's** ability to comply with the **PPOs**; and
 - (e) any other matter the **system operator** reasonably considers relevant.
- (2) When considering the matters under subclause (1), the **system operator** must—
 - (a) ask the **Authority** for the **Authority's** view; and
 - (b) consider the **Authority's** view.

Clause 3(1)(aa): inserted, on 1 March 2024, by clause 11 of the Electricity Industry Participation Code Amendment (Dispatch Notification Enhancement and Clarifications) 2024.

Clause 3(1)(b)(iii): amended, on 1 November 2022, by clause 182(1) of the Electricity Industry Participation Code Amendment (Real Time Pricing) 2022.

Clause 3(1)(c): amended, on 1 November 2022, by clause 182(2) of the Electricity Industry Participation Code Amendment (Real Time Pricing) 2022.

Clause 3(1)(d): amended, on 1 November 2022, by clause 182(3) of the Electricity Industry Participation Code Amendment (Real Time Pricing) 2022.

Clause 3(2): amended, on 1 November 2022, by clause 182(4) of the Electricity Industry Participation Code Amendment (Real Time Pricing) 2022.

4 System operator may request additional information

- (1) Subclauses (2) and (3) apply to—
 - (a) a **participant** that has applied to the **system operator** to have a device or a group of devices approved as a **dispatch-capable load station**; and
 - (b) a **purchaser** that has a **dispatch-capable load station** that has been approved.
- (2) The **system operator** may request a **participant** to which this clause applies to provide additional information.
- (3) The **participant** must provide the requested information to the **system operator**.
- (4) As soon as practicable after receiving the requested information, the **system operator** must provide a copy of the information to the **Authority**.

5 Applicant may withdraw or amend application at any time

- (1) An applicant may, at any time, amend or withdraw an application.
- (2) An applicant must make an amendment or withdrawal—
 - (a) in writing; and
 - (b) by submitting it to the **system operator**.
- (3) An amendment or a withdrawal takes effect from the date of receipt by the **system operator**.
- (4) As soon as practicable after receiving an amendment or a withdrawal, the **system operator** must—
 - (a) provide the amendment or withdrawal to the **Authority**; and
 - (b) advise all **participants** listed in clause 2(b) of the amendment or withdrawal.

6 System operator's decision

- (1) The **system operator** must decide whether to—
 - (a) approve an application; or
 - (b) decline an application.
- (1A) Where the **system operator** decides to approve an application under subclause (1) and the **dispatch-capable load station** consists of devices or a group of devices located at more than one **GXP**, the **system operator** must—
 - (a) assign a primary **GXP** at which **nominated bids** are to be submitted for that **dispatch-capable load station**; and
 - (b) specify one or more alternative **GXPs** at which, following the **system operator** giving reasonable notice under clause 13.7(4)(b), **nominated bids** are to be submitted for that **dispatch-capable load station**.
- (2) If the **system operator** decides to approve an application, the **system operator** must assign a **dispatch-capable load station identifier** to each approved **dispatch-capable load station** and, if subclause (1A) applies, must assign separate **dispatch-capable load station identifiers** for the primary and alternative **GXPs** at which **nominated bids** are to be submitted.
- (3) The **system operator** must, as soon as practicable after making a decision, advise the parties listed in subclause (4) in writing of—
 - (a) the decision; and
 - (b) if the decision is to approve the application, any conditions that apply to the approval; and
 - (c) the **system operator's** reasons for the decision.
- (4) For the purpose of subclause (3), the **system operator** must advise the following parties:
 - (a) the applicant;
 - (b) the **Authority**;
 - (c) all **participants** listed in clause 2(b).

Clause 6(1A): inserted, on 1 March 2024, by clause 12(1) of the Electricity Industry Participation Code Amendment (Dispatch Notification Enhancement and Clarifications) 2024.

Clause 6(2): amended, on 1 March 2024, by clause 12(2) of the Electricity Industry Participation Code Amendment (Dispatch Notification Enhancement and Clarifications) 2024.

7 System operator may impose conditions

- (1) The **system operator** may impose conditions on any approval it grants under this Schedule.
- (2) Conditions may include, but are not limited to, 1 or more of the following:
 - (a) a requirement that the applicant has in place real time indications and measurements to the satisfaction of the **system operator**:

- (b) a requirement that the applicant has in place a system for communicating with the **system operator** to the satisfaction of the **system operator**;
- (c) a requirement that the applicant performs tests of load controlling systems on a regular basis.

8 Timeframe for decision

- (1) The **system operator** must make a decision under clause 6(1)—
 - (a) within 20 **business days** after—
 - (i) the date on which the **system operator** receives the application; or
 - (ii) if the application is amended under clause 5, the date on which the **system operator** receives the amendment; or
 - (b) within any other period of time that has been agreed by the applicant and the **system operator**.
- (2) Despite subclause (1), if the **system operator** requests additional information from the applicant under clause 4, the timeframes in subclause (1) are extended by the number of days the applicant takes to provide the additional information.

9 Effect of approval

- (1) When approving an application for a **dispatch-capable load station**, the **system operator** must specify a date from which the approval takes effect.
- (2) The **system operator** must not set a date from which an approval takes effect that is earlier than 10 **business days** after the date on which the approval was granted.
- (3) An approval of a **dispatch-capable load station** takes effect from the date specified in the approval.

10 System operator may amend, revoke, or suspend approval

- (1) The **system operator** may, at its own discretion or on the request of the **Authority** or a **dispatchable load purchaser**,—
 - (a) amend an approval; or
 - (b) revoke an approval; or
 - (c) suspend an approval.
- (2) An amendment takes effect from—
 - (a) the date it is made; or
 - (b) a later date specified by the **system operator**.
- (3) A revocation takes effect from—
 - (a) the date it is made; or
 - (b) a later date specified by the **system operator**.
- (4) A suspension—
 - (a) takes effect from—
 - (i) the date it is made; or
 - (ii) a later date specified by the **system operator**; and
 - (b) remains in effect until a date specified by the **system operator**.

11 System operator to give reasons for amending, revoking, or suspending approval

As soon as practicable after the **system operator** amends, revokes, or suspends an approval under this Schedule, the **system operator** must advise the **purchaser**, the **Authority**, and all **participants** listed in clause 2(b) of—

- (a) the revocation, suspension, or amendment; and

(b) the reasons for the revocation, suspension, or amendment.

Clause 11: amended, on 1 November 2022, by clause 183 of the Electricity Industry Participation Code Amendment (Real Time Pricing) 2022.

12 Authority to keep register of all current approvals

- (1) The **Authority** must keep a register of all current approvals—
 - (a) granted under this Schedule; and
 - (b) of which the **system operator** has advised the **Authority**.
- (2) The **Authority** must keep the register available for public inspection free of charge—
 - (a) at its offices, during normal office hours; and
 - (b) on its website, at all reasonable times.
- (3) The register must state, for each approval granted,—
 - (a) the name of the applicant; and
 - (b) the name of the **dispatch-capable load station**; and
 - (c) the **dispatch-capable load station identifier(s)**; and
 - (d) the date from which the approval takes effect; and
 - (e) any conditions.

Clause 12(1)(b): replaced, on 5 October 2017, by clause 494 of the Electricity Industry Participation Code Amendment (Code Review Programme) 2017.

Clause 12(3)(c): amended, on 1 March 2024, by clause 13 of the Electricity Industry Participation Code Amendment (Dispatch Notification Enhancement and Clarifications) 2024.

Electricity Industry Participation Code 2010

Part 14 Clearing and settlement

Part 14: substituted, on 24 March 2015, by clause 20 of the Electricity Industry Participation (Settlement and Prudential Security) Code Amendment 2013.

Contents

Subpart 1—Sale and purchase of electricity

- 14.1 Contents of this Part
- 14.1A Clearing manager may require additional information
- 14.2 Sale and purchase of electricity
- 14.3 Sale by generators with point of connection to grid
- 14.4 Sale by generators with point of connection to local network or embedded network
- 14.5 On sale by participants
- 14.6 Purchase of offtake through point of connection to grid
- 14.7 Purchase of offtake through local network by embedded generator

Subpart 2—Hedge settlement agreements

- 14.8 Hedge settlement agreement lodgement
- 14.9 Cancellation of hedge settlement agreement

Subpart 3—Amounts owing

- 14.10 Amounts owing for electricity
- 14.11 Amounts owing for constrained off compensation and constrained on compensation
- 14.12 Amounts owing for washup amounts
- 14.13 Amounts owing for auction revenue
- 14.14 Amounts owing for ancillary services
- 14.14A *[Revoked]*
- 14.15 Amounts owing for hedge settlement agreements
- 14.16 Calculation of loss and constraint excess
- 14.17 Amounts owing for FTRs

Subpart 4—Notice of amounts owing and payable

Information about amounts owing and payable

- 14.18 Clearing manager to advise participant of amounts owing and payable
- 14.19 Amounts owing by participant to clearing manager
- 14.20 Amounts owing by clearing manager to participant
- 14.21 Methodology for determining settlement retention amount
- 14.22 Calculation of amount payable

Procedure for advising participants of amounts owing and payable

- 14.23 Procedure for advising participant of amounts owing and payable
- 14.24 *[Revoked]*

Disputes about amounts

- 14.25 Participant may dispute amount
- 14.26 Resolution of dispute about amount
- 14.27 Dispute about amount may be referred to Rulings Panel
- 14.28 Correction of information about amount as result of dispute

Subpart 5—Payments

- 14.29 Payment of amounts payable
- 14.30 Prepayment of amounts payable
- 14.31 Deadlines for payments
- 14.32 Methods of payment
- 14.33 Allocation of payments
- 14.34 Payments by clearing manager
- 14.34A Payment of residual funds from operating accounts
- 14.35 Payment of residual loss and constraint excess
- 14.35A Allocation and payment of settlement residue by grid owner

Subpart 6—Washups

- 14.36 Clearing manager to conduct washups
- 14.37 Clearing manager to advise participants of washup amounts
- 14.38 Washup amounts
- 14.39 Washups for grid owners
- 14.40 Payment where no longer participant

Subpart 7—Events of default

Types of default

- 14.41 Definition of an event of default

Procedure for event of default

- 14.42 Clearing manager to advise Authority of anticipated event of default
- 14.43 Procedure upon event of default

Remedies and rights of recovery

- 14.44 Event of default gives clearing manager remedies
- 14.45 Remedies for settlement default
- 14.46 Remedies for other types of default
- 14.47 Application to take possession of FTR
- 14.48 Cancellation of hedge settlement agreement in event of default
- 14.49 Electrical disconnection of direct purchaser
- 14.50 Clearing manager to exercise rights to recover amounts outstanding
- 14.51 Participants assigned or subrogated to all clearing manager's rights of recovery
- 14.52 Rights of participants to exercise rights

Publication of information about event of default

- 14.53 Authority may publish information about event of default
Subpart 8—Payments in event of settlement default
- 14.54 Application of this subpart
- 14.55 Allocation of shortfall to settlement of general amounts and FTRs
- 14.56 Calculation of revised amount owing for general amounts
- 14.57 Calculation of revised amount owing for FTR amounts
- 14.58 Calculation of scaled amount payable
- 14.59 Calculation of revised amount payable
- 14.60 Payment of revised amount payable
- 14.61 Payment by participant with negative scaled amount payable
- 14.62 Application of payment by participant with negative scaled amount payable
- 14.63 Further funds paid according to priority
- 14.64 Interest payable to participants
- 14.65 Participant to remain in default
Subpart 9—Administrative obligations of clearing manager
Clearing manager operating account
- 14.66 Clearing manager to establish operating account
- 14.67 Payment by clearing manager
Reporting obligations of the clearing manager
- 14.68 *[Revoked]*
- 14.69 *[Revoked]*
- 14.70 *[Revoked]*
- 14.71 Clearing manager to make block dispatch settlement differences available
- 14.72 Clearing manager to make block dispatch settlement differences available later if clearing manager’s external system unavailable
- 14.73 Clause 14.71 applies to block dispatch groups
- 14.74 No washup calculation under clause 14.71 if revised reconciliation information is received
Notices
- 14.75 Notices

Schedule 14.1

Formula for scaling amount owing in respect of FTRs

Schedule 14.2

Consultation and approval requirements for methodologies

Schedule 14.3

Calculation of amount of loss and constraint excess to be applied to the settlement of FTRs

Schedule 14.4

Form of hedge settlement agreement

14.1 Contents of this Part

This Part provides for—

- (a) the sale and purchase of **electricity** to and from the **clearing manager**; and
- (b) the calculation and invoicing of amounts owing to and by the **clearing manager** for **electricity, ancillary services, FTRs**, and other payments that may be received or paid by the **clearing manager**; and
- (c) the settlement of amounts payable under this Part; and
- (d) processes and remedies for an **event of default**; and
- (e) obligations of the **clearing manager** in relation to clearing and settlement, including reporting obligations and requirements for the **operating account** that must be established and held by the **clearing manager**.

Clause 14.1(b): amended, on 24 March 2015, by clause 24 of the Electricity Industry Participation Code Amendment (Extended Reserve) 2014.

Clause 14.1(b): amended, on 21 December 2021, by clause 32 of the Electricity Industry Participation Code Amendment (Automatic Under-Frequency Load Shedding Systems) 2021.

14.1A Clearing manager may require additional information

- (1) The **clearing manager** may require information from a **participant** by notice to the **participant** where the information is necessary for the purpose of the **clearing manager** carrying out its role in accordance with this Code.
- (2) Information required under subclause (1) may include information that the **clearing manager** reasonably requires, in the course of carrying out its role in accordance with the Code, to comply with its obligations under legislation other than the Code.
- (3) A **participant** who receives a notice under subclause (1) must, as soon as practicable, provide the information required in the notice to the **clearing manager**.

Clause 14.1A: inserted, on 1 March 2024, by clause 90 of the Electricity Industry Participation Code Amendment (Code Review Programme) 2024.

Subpart 1—Sale and purchase of electricity

14.2 Sale and purchase of electricity

- (1) The **clearing manager** must—
 - (a) purchase **electricity** sold to the **clearing manager** in accordance with clauses 14.3 to 14.5; and
 - (b) sell **electricity** purchased from the **clearing manager** in accordance with clause 14.6.
- (2) Each **generator** must sell **electricity** in accordance with clauses 14.3 and 14.4.
- (3) Each **purchaser** must purchase **electricity** in accordance with clause 14.6.
- (4) Each **participant** that sells or purchases **electricity** through a **local network** or **embedded network** must sell and purchase the **electricity** in accordance with clauses 14.4, 14.5, and 14.7.

- (5) The amount owing for **electricity** purchased under this Part must be determined in accordance with clause 14.10.

Clause 14.2(5): amended, on 24 March 2015, by clause 4 of the Electricity Industry Participation Code Amendment (Late and Revised Data) 2015.

14.3 Sale by generators with point of connection to grid

- (1) This clause applies to each **generator** that has a **generating station** or **generating unit** with a **point of connection** to the **grid**.
- (2) Each **generator** to which this clause applies must sell to the **clearing manager** all **electricity** generated by the **generator's generating station** or **generating unit** injected through a **point of connection** to the **grid**.

14.4 Sale by generators with point of connection to local network or embedded network

- (1) This clause—
- (a) applies to each **generator** that has an **embedded generating station**; but
- (b) does not apply to a **generator** in respect of an **embedded generating station** in relation to a **point of connection** for which a notice under clause 15.13 is in force.
- (2) Each **generator** to which this clause applies must sell all **electricity** generated by the **embedded generating station** and injected through a **point of connection** with the **local network** or **embedded network** to—
- (a) the **clearing manager**; or
- (b) a **participant** trading on the **local network** or **embedded network**.
- (3) Despite anything to the contrary in this Code, the relevant **point of connection** to the **grid** is, for the purposes of reconciliation under this Code, deemed to be a **grid injection point**.

Clause 14.4(1)(b): amended, on 1 November 2018, by clause 97 of the Electricity Industry Participation Code Amendment (Code Review Programme) 2018.

Clause 14.4(1)(b): amended, on 20 December 2021, by clause 63 of the Electricity Industry Participation Code Amendment (Code Review Programme) 2019.

14.5 On sale by participants

If an **embedded generator** sells **electricity** to a **participant** under clause 14.4, the **participant** must at the same time on-sell that **electricity** to the **clearing manager**.

14.6 Purchase of offtake through point of connection to grid

Each **purchaser** must purchase from the **clearing manager** the **electricity** allocated to the **purchaser** under Part 15 in respect of a **point of connection** to the **grid**.

14.7 Purchase of offtake through local network by embedded generator

- (1) A **generator** that purchases **electricity** at the same **point of connection** with a **local network** at which it sells **electricity** in accordance with clause 14.4 must purchase the **electricity** from the same **participant** to which it sold its **electricity** under clause 14.4.
- (2) The **participant** from which electricity is purchased under subclause (1) must sell the **electricity** as set out in this Code.

Subpart 2—Hedge settlement agreements

14.8 Hedge settlement agreement lodgement

- (1) If a **hedge settlement agreement** that is signed by 2 **participants** is submitted to the **clearing manager**, subject to subclauses (2) and (3), it is validly lodged when it is signed by the **clearing manager**.
- (2) A **hedge settlement agreement** must be in 1 of the forms set out in Schedule 14.4, or in an alternative form approved by the **Authority**.
- (3) The **clearing manager** may only sign a **hedge settlement agreement** submitted under subclause (1) if the **clearing manager** is satisfied that, after the **hedge settlement agreement** is lodged, at least 1 **participant** to the **hedge settlement agreement** will have a physical position in **MW** that is 33% or more of its **hedge settlement agreement** position in **MW** in any month calculated under paragraph (b) of subclause (4).
- (4) For the purposes of subclause (3),—
 - (a) a **participant's** physical position in **MW** is the greater of the following:
 - (i) the average of the **participant's** generation in **MW** over the last 12 months based on **reconciled quantities**;
 - (ii) the average of the **participant's** generation in **MW** over the last month based on **reconciled quantities**;
 - (iii) the average of the **participant's** purchases in **MW** over the last 12 months based on **reconciled quantities**;
 - (iv) the average of the **participant's** purchases in **MW** over the last month based on **reconciled quantities**; and
 - (b) the sum of the average **MW** of each of the **participant's hedge settlement agreements** for any month to which the **hedge settlement agreement** applies.
- (5) When a **participant** submits a **hedge settlement agreement** to the **clearing manager**, the **participant** must also provide any other information relating to the **hedge settlement agreement** that the **clearing manager** requires.
- (6) A **participant** must provide information under subclause (5) in a form the **clearing manager** prescribes and specifies to **participants**.

Clause 14.8(6): amended, on 1 November 2018, by clause 98 of the Electricity Industry Participation Code Amendment (Code Review Programme) 2018.

14.9 Cancellation of hedge settlement agreement

- (1) A **hedge settlement agreement** may be cancelled only in the following situations:
 - (a) if an **event of default** has occurred and is continuing in relation to a party to the **hedge settlement agreement**, in accordance with clause 14.48;
 - (b) if no **event of default** is continuing in relation to either of the parties to the **hedge settlement agreement**, in accordance with subclause (2).
- (2) A party to a **hedge settlement agreement** may cancel the **hedge settlement agreement** under subclause (1)(b) if both parties to the **hedge settlement agreement** agree in writing to the cancellation and either—
 - (a) the parties give the **clearing manager** at least 90 days' notice of the cancellation;or

- (b) the parties give the **clearing manager** less than 90 days' notice of the cancellation and the **clearing manager** agrees to the cancellation in accordance with subclause (3).
- (3) The **clearing manager** may agree to the cancellation of a **hedge settlement agreement** under subclause (2)(b) only if the **clearing manager** is satisfied that—
 - (a) immediately following the cancellation of the **hedge settlement agreement**, each party will—
 - (i) continue to meet the requirements in clause 14A.4(1); or
 - (ii) meet the requirements in clause 14A.3; and
 - (b) the cancellation of the **hedge settlement agreement** is not otherwise contrary to the interests of **participants** to which an amount is payable under this Part.
- (4) In deciding whether to agree to the cancellation of a **hedge settlement agreement**, the **clearing manager** may consult with the **Authority**.

Subpart 3—Amounts owing

14.10 Amounts owing for electricity

- (1) The **clearing manager** must determine the amount owing for **electricity** purchased under clauses 14.2 to 14.7 using the following formula:

$$Q * P_f$$

where

Q is the quantity of **electricity** allocated to the **participant** for each **trading period** for each **point of connection** to the **grid** determined in accordance with **reconciliation information** and summarised and loss adjusted **dispatchable load information**

P_f is the **final price** for each relevant **point of connection** to the **grid** for each **trading period**

- (2) The **clearing manager** must determine the amount owing for **electricity** sold under clauses 14.2 to 14.7 using the following formula:

$$Q * P_f$$

where

Q is the quantity of **electricity** allocated to the **participant** for each **trading period** for each **point of connection** to the **grid** determined in accordance with **reconciliation information**

P_f is the **final price** for each relevant **point of connection** to the **grid** for each **trading period**

- (3) The quantity of **electricity** bought by a **purchaser** or sold by a **generator** under subpart 1 must be determined in accordance with clauses 15.20A to 15.26.
- (4) The **final price** of **electricity** bought by a **purchaser** or sold by a **generator** under subpart 1 must be determined in accordance with clauses 13.82A to 13.184.

Clause 14.10(1) and (2): amended, on 1 November 2022, by clause 184(1) of the Electricity Industry Participation Code Amendment (Real Time Pricing) 2022.

Clause 14.10(4): amended, on 1 November 2022, by clause 184(2) of the Electricity Industry Participation Code Amendment (Real Time Pricing) 2022.

14.11 Amounts owing for constrained off compensation and constrained on compensation

The **clearing manager** must determine amounts owing in respect of **constrained off compensation** and **constrained on compensation** in accordance with clauses 13.192 to 13.212.

14.12 Amounts owing for washup amounts

The **clearing manager** must determine amounts owing in respect of **washup** amounts in accordance with subpart 6.

14.13 Amounts owing for auction revenue

The **clearing manager** must determine amounts owing in respect of **auction revenue** in accordance with clauses 13.110 to 13.112.

14.14 Amounts owing for ancillary services

The **clearing manager** must determine amounts owing in respect of **ancillary services** in accordance with clauses 8.6, 8.31, 8.55, and 8.68.

Clause 14.14: amended, on 24 March 2015, by clause 25 of the Electricity Industry Participation Code Amendment (Extended Reserve) 2014.

Clause 14.14: amended, on 21 December 2021, by clause 33 of the Electricity Industry Participation Code Amendment (Automatic Under-Frequency Load Shedding Systems) 2021.

14.14A [Revoked]

Clause 14.14A: inserted, on 24 March 2015, by clause 26 of the Electricity Industry Participation Code Amendment (Extended Reserve) 2014.

Clause 14.14A: revoked, on 21 December 2021, by clause 34 of the Electricity Industry Participation Code Amendment (Automatic Under-Frequency Load Shedding Systems) 2021.

14.15 Amounts owing for hedge settlement agreements

The **clearing manager** must calculate amounts owing under a **hedge settlement agreement** in respect of the current **billing period** in accordance with the terms of the **hedge settlement agreement**.

14.16 Calculation of loss and constraint excess

- (1) A **loss and constraint excess** accrues for a **billing period** when the total of the amounts owing by the **clearing manager** to **generators** for that **billing period** for the **electricity** sold and purchased in accordance with clause 14.3 is less than the total amount owing to the **clearing manager** for that **billing period** for the **electricity** sold and purchased in accordance with clause 14.6.
- (2) The **FTR manager** must—
 - (a) determine the amount of **loss and constraint excess** that must be applied to the settlement of **FTRs** in accordance with Schedule 14.3; and
 - (b) advise the **clearing manager** of that amount no later than—

- (i) 1600 hours on the 7th **business day** of the month following the relevant **billing period**; or
 - (ii) if **publication of final prices** is delayed for any **trading period** in the relevant **billing period**, so that **final prices** for a **trading period** in the **billing period** are **published** later than 1600 hours on the 6th **business day** of the month following the relevant **billing period**, 1 **business day** after all **final prices** for the **billing period** are **published**.
- (3) Each **grid owner** and the **system operator** must provide information to the **FTR manager** in accordance with Schedule 14.3.
 - (4) Subject to subpart 8, the **clearing manager** must apply the amount advised under subclause (2) to the settlement of **FTRs**.
 - (5) Subject to subpart 8, if the amount that the **FTR manager** advises the **clearing manager** under subclause (2) exceeds the amount of the **loss and constraint excess** for the **billing period**, the **clearing manager** must apply all of the **loss and constraint excess** to the settlement of **FTRs**.
 - (6) The **Authority** must advise the **clearing manager** of the proportion of the **loss and constraint excess** and **residual loss and constraint excess** owing to each **grid owner**.
 - (7) Unless the **Authority** has directed otherwise under this clause, the amount owing to each **grid owner** in the proportions advised under subclause (6) is—
 - (a) the amount of any **loss and constraint excess** less the amount to be applied to the settlement of **FTRs** under subclause (4) or (5); and
 - (b) the amount of any **residual loss and constraint excess**.

Clause 14.16(2)(b): substituted, on 24 March 2015, by clause 10 of the Electricity Industry Participation Code Amendment (Settlement and Prudential Security) 2014.

Clause 14.16(3): amended, on 1 November 2022, by clause 185 of the Electricity Industry Participation Code Amendment (Real Time Pricing) 2022.

14.17 Amounts owing for FTRs

- (1) The **clearing manager** must calculate, for each **billing period**, the amount owing—
 - (a) by a **participant** to the **clearing manager** in respect of each **FTR** for which the **participant** is registered as the holder of the **FTR**; and
 - (b) by the **clearing manager** to a **participant** in respect of each **FTR** for which the **participant** is registered as the holder of the **FTR**; and
 - (c) by a **participant** to the **clearing manager** in respect of the assignment of an **FTR** under clause 13.249(4); and
 - (d) by the **clearing manager** to a **participant** in respect of the assignment of an **FTR** under clause 13.249(7).
- (2) The amount owing by a **participant** to the **clearing manager** in respect of an **FTR** is the net amount of the **FTR acquisition cost** for the **FTR** minus the **FTR hedge value** for the **FTR**, if that net amount is positive.
- (3) The amount owing by the **clearing manager** to a **participant** in respect of an **FTR** is the net amount of the **FTR hedge value** for the **FTR** minus the **FTR acquisition cost** for the **FTR**, if that net amount is positive.
- (4) The **clearing manager** must **publish**, for each **billing period**,—
 - (a) the amount owing by a **participant** to the **clearing manager** for each **FTR**; and
 - (b) the amount owing by the **clearing manager** to a **participant** for each **FTR**.

- (5) Subclause (6) applies if, in respect of a **billing period**, the total amount to be advised as owing by the **clearing manager** under paragraphs (b) and (d) of subclause (1) exceeds the sum of the following amounts:
- (a) the total amount to be advised as owing to the **clearing manager** under subclause (1)(a):
 - (b) any amount available under clause 13.249(6) for the settlement of **FTRs** in the **billing period**:
 - (c) the amount of the **loss and constraint excess** to be applied to the settlement of **FTRs** under clause 14.16(4) or (5).
- (6) The **clearing manager** must, in calculating the amount owing in respect of each **FTR** under paragraph (a) or (b) of subclause (1), use an amended **FTR hedge value** scaled according to the formula specified in Schedule 14.1.

Subpart 4—Notice of amounts owing and payable

Heading amended, on 1 November 2018, by clause 99 of the Electricity Industry Participation Code Amendment (Code Review Programme) 2018.

Information about amounts owing and payable

14.18 Clearing manager to advise participant of amounts owing and payable

- (1) The **clearing manager** must advise each **participant**, for which the **clearing manager** has determined that the **participant** owes or is owed an amount under subpart 3, the following:
- (a) amounts owing by the **participant** to the **clearing manager** in accordance with clause 14.19:
 - (b) amounts owing by the **clearing manager** to the **participant** in accordance with clause 14.20:
 - (c) the amount of the settlement retention amount calculated in accordance with the methodology **published** by the **clearing manager** under clause 14.21:
 - (d) any amount payable by the **participant** to the **clearing manager** and any amount payable by the **clearing manager** to the **participant** under subpart 5 in accordance with clause 14.22.
- (2) The **clearing manager** must advise each **participant** of each amount owing and each amount payable as follows:
- (a) no later than the 9th **business day** of the month following the **billing period**; but
 - (b) if the **clearing manager** has not received any information required to determine an amount payable in respect of the prior **billing period** in time to advise each **participant** by that date,—
 - (i) if the **clearing manager** receives the information in time to advise each **participant** of each amount owing and each amount payable 2 **business days** or more before the 20th day of the month, the **clearing manager** must advise each **participant** no later than 2 **business days** before the 20th day of the month; or
 - (ii) if the **clearing manager** does not receive, or considers that it is not likely to receive, the information in time to advise each **participant** of each amount

owing and each amount payable 2 **business days** before the 20th day of the month,—

- (A) the **clearing manager** must refer the matter to the **Authority**; and
- (B) the **Authority** must direct the **clearing manager** as to the time by which the **clearing manager** must advise each **participant** of each amount owing and each amount payable; and
- (C) the **clearing manager** must advise each **participant** by the time directed by the **Authority**.

- (3) A **participant** must not issue a **GST** invoice for supplies of **electricity**, **ancillary services**, or **ancillary service administrative costs** to the **clearing manager**.

Clause 14.18(2): substituted, on 24 March 2015, by clause 5 of the Electricity Industry Participation Code Amendment (Late and Revised Data) 2015.

Clause 14.18(2)(b)(i) and (ii): amended, on 5 October 2017, by clause 495 of the Electricity Industry Participation Code Amendment (Code Review Programme) 2017.

Clause 14.18(3): amended, on 24 March 2015, by clause 27 of the Electricity Industry Participation Code Amendment (Extended Reserve) 2014.

Clause 14.18: amended, on 21 December 2021, by clause 35 of the Electricity Industry Participation Code Amendment (Automatic Under-Frequency Load Shedding Systems) 2021.

14.19 Amounts owing by participant to clearing manager

- (1) When advising a **participant** of amounts owing under clause 14.18(1)(a), the **clearing manager** must specify any amount owing by the **participant** to the **clearing manager** for—

- (a) the relevant **billing period**, to the extent that the **clearing manager** has received the necessary information; and
- (b) any prior **billing period** if the **clearing manager** receives the necessary information for that **billing period** after the date that amounts owing for that **billing period** were required to be advised by the **clearing manager**.

- (2) The **clearing manager** must specify any amount owing by the **participant** to the **clearing manager** in respect of the periods referred to in subclause (1) for the following:

- (a) **electricity** purchased under clauses 14.2 to 14.7:
- (b) **constrained off compensation** under clause 13.201A:
- (c) **constrained on compensation** under clause 13.212:
- (d) a **washup** amount and any interest on that amount under subpart 6:
- (e) **auction revenue** under clause 13.110:
- (f) **ancillary services** under clauses 8.6, 8.31(1)(a), and 8.68:
- (fa) *[Revoked]*
- (g) payment of an amount under any **hedge settlement agreement**:
- (h) for each **FTR** in respect of which the **participant** is registered as the holder of the **FTR**, the net amount of the **FTR acquisition cost** for the **FTR** minus the **FTR hedge value** for the **FTR**, if that net amount is positive:
- (i) any amount owing in respect of the assignment of any **FTR** under clause 13.249(4):
- (j) **GST**.

- (3) The **clearing manager** must specify the sum of the amounts referred to in subclause

(2).

Clause 14.19(2)(f): amended, on 24 March 2015, by clause 28(1) of the Electricity Industry Participation Code Amendment (Extended Reserve) 2014.

Clause 14.19(2)(f): amended, on 21 December 2021, by clause 36(1) of the Electricity Industry Participation Code Amendment (Automatic Under-Frequency Load Shedding Systems) 2021.

Clause 14.19(2)(fa): inserted, on 24 March 2015, by clause 28(2) of the Electricity Industry Participation Code Amendment (Extended Reserve) 2014.

Clause 14.19(2)(fa): revoked, on 21 December 2021, by clause 36(2) of the Electricity Industry Participation Code Amendment (Automatic Under-Frequency Load Shedding Systems) 2021.

14.20 Amounts owing by clearing manager to participant

(1) When advising a **participant** of amounts owing under clause 14.18(1)(b), the **clearing manager** must specify any amount owing by the **clearing manager** to the **participant** for—

(a) the relevant **billing period**, to the extent that the **clearing manager** has received the necessary information; and

(b) any prior **billing period** if the **clearing manager** receives the necessary information for that **billing period** after the date that amounts owing for that **billing period** were required to be advised by the **clearing manager**.

(2) The **clearing manager** must specify any amount owing by the **clearing manager** to the **participant** in respect of the periods referred to in subclause (1) for the following:

(a) **electricity** sold under clauses 14.2 to 14.7:

(b) **constrained off compensation** under clause 13.201A:

(c) **constrained on compensation** under clause 13.212:

(d) a **washup** amount and any interest on that amount under subpart 6:

(e) **auction revenue** under clause 13.112:

(f) **ancillary services** under clause 8.55(a):

(fa) *[Revoked]*

(g) payment of an amount under any **hedge settlement agreement**:

(h) for each **FTR** in respect of which the **participant** is registered as the holder of the **FTR**, the net amount of the **FTR hedge value** for the **FTR** minus the **FTR acquisition cost** for the **FTR**, if that net amount is positive:

(i) any amount owing in respect of the assignment of any **FTR** under clause 13.249(7):

(j) **GST**:

(k) **loss and constraint excess** and **residual loss and constraint excess** under clause 14.16(7).

(3) The **clearing manager** must specify the sum of the amounts referred to in subclause (2).

Clause 14.20(2)(fa): inserted, on 24 March 2015, by clause 29 of the Electricity Industry Participation Code Amendment (Extended Reserve) 2014.

Clause 14.20(2)(fa): revoked, on 21 December 2021, by clause 37 of the Electricity Industry Participation Code Amendment (Automatic Under-Frequency Load Shedding Systems) 2021.

14.21 Methodology for determining settlement retention amount

(1) The **clearing manager** must formulate and **publish** a methodology for determining the settlement retention amount to be advised to a **participant** in accordance with clause 14.18(1)(c).

- (2) The methodology formulated by the **clearing manager** under subclause (1) must comply with the principle that the settlement retention amount is set to ensure that the **clearing manager** has sufficient funds to pay each non-defaulting **participant** the amount payable to that **participant** under subpart 5 if both of the following occur:
- (a) a **settlement default** that results in the largest percentage reduction in payments that would be made in the absence of the settlement retention amount in respect of amounts other than **FTRs**; and
 - (b) a **settlement default** that results in the largest percentage reduction in payments that would be made in the absence of the settlement retention amount in respect of **FTRs** (other than in respect of the **residual loss and constraint excess**).
- (3) For the purposes of subclause (2), multiple **settlement defaults** by parties related in any way specified in the methodology must be treated as 1 **settlement default**.
- (4) The consultation and approval requirements set out in Schedule 14.2 apply to the methodology.

14.22 Calculation of amount payable

- (1) The amount payable by a **participant** to the **clearing manager** under clause 14.31 is determined in accordance with the following formula:

$$AP_P = \text{Max} [0, AO_P - AO_{CM} + SRA]$$

where

AP_P is the amount payable by the **participant** to the **clearing manager**

AO_P is the sum of the amounts owing by the **participant** to the **clearing manager**, calculated under clause 14.19

AO_{CM} is the sum of the amounts owing by the **clearing manager** to the **participant**, calculated under clause 14.20

SRA is the settlement retention amount, calculated in accordance with the methodology **published** by the **clearing manager** under clause 14.21

- (2) Subject to subpart 8, the amount payable by the **clearing manager** to a **participant** in accordance with clause 14.34 is determined in accordance with the following formula:

$$AP_{CM} = AO_{CM} - AO_P + AP_P$$

where

AP_{CM} is the amount payable by the **clearing manager** to the **participant**

AO_{CM} is the sum of the amounts owing by the **clearing manager** to the **participant**, calculated under clause 14.20

AO_P is the sum of the amounts owing by the **participant** to the **clearing manager**, calculated under clause 14.19

AP_P is the amount payable under subclause (1) (if any)

Procedure for advising participants of amounts owing and payable

14.23 Procedure for advising participant of amounts owing and payable

- (1) When advising a **participant** of amounts owing and payable under this subpart, the **clearing manager** must—
 - (a) submit the information to each relevant **participant** through the **clearing manager's** external system; and
 - (aa) **publish** aggregated information within one month after each **billing period**.
 - (b) *[Revoked]*
- (2) Proof of making the information available on the **clearing manager's** external system is deemed to be proof of the advice under subclause (1).

Clause 14.23(1)(a): replaced, on 5 October 2017, by clause 496(1) of the Electricity Industry Participation Code Amendment (Code Review Programme) 2017.

Clause 14.23(1)(a): amended, on 1 March 2024, by clause 91(1) of the Electricity Industry Participation Code Amendment (Code Review Programme) 2024.

Clause 14.23(1)(aa): inserted, on 5 October 2017, by clause 496(1) of the Electricity Industry Participation Code Amendment (Code Review Programme) 2017.

Clause 14.23(1)(aa): amended, on 1 March 2024, by clause 91(2) of the Electricity Industry Participation Code Amendment (Code Review Programme) 2024.

Clause 14.23(1)(b): revoked, on 1 March 2024, by clause 91(3) of the Electricity Industry Participation Code Amendment (Code Review Programme) 2024.

Clause 14.23(2): amended, on 5 October 2017, by clause 496(2) of the Electricity Industry Participation Code Amendment (Code Review Programme) 2017.

Clause 14.23(2) amended, on 1 March 2024, by clause 91(4) of the Electricity Industry Participation Code Amendment (Code Review Programme) 2024.

14.24 *[Revoked]*

Clause 14.24(1): amended, on 5 October 2017, by clause 497(1) of the Electricity Industry Participation Code Amendment (Code Review Programme) 2017.

Clause 14.24(2): replaced, on 5 October 2017, by clause 497(2) of the Electricity Industry Participation Code Amendment (Code Review Programme) 2017.

Clause 14.24(3): replaced, on 5 October 2017, by clause 497(3) of the Electricity Industry Participation Code Amendment (Code Review Programme) 2017.

Clause 14.24: revoked, on 1 March 2024, by clause 92 of the Electricity Industry Participation Code Amendment (Code Review Programme) 2024

Disputes about amounts

14.25 Participant may dispute amount

- (1) A **participant** may dispute information about an amount that is provided by the **clearing manager** under this subpart by notice in writing to the **clearing manager**.
- (2) A **participant** may not—
 - (a) dispute the information under subclause (1) after the expiry of 2 years after the date that the information is provided; or
 - (b) commence a dispute under subclause (1) if the **participant** has commenced a dispute in relation to the **volume information** on which the information is based under clause 15.29, and the dispute remains unresolved.
- (3) The **clearing manager** must advise all **participants** materially affected by the dispute and the **Authority** of the dispute no later than 1 **business day** after the **clearing manager** receives notice of the dispute under subclause (1).
- (4) On receiving advice of a dispute that relates to **volume information** under subclause (3), the **Authority** may direct that no further action be taken in respect of the dispute.
- (5) If the **Authority** gives a direction under subclause (4), clauses 14.26 to 14.28 cease to

apply to the dispute.

- (6) A direction under subclause (4) does not affect the validity of information provided under clause 14.26(2) or clause 14.37 before the direction was given.

Clause 14.25(2)(b): amended, on 24 March 2015, by clause 6 of the Electricity Industry Participation Code Amendment (Late and Revised Data) 2015.

Clause 14.25(3) and (4): amended, on 1 November 2018, by clause 100 of the Electricity Industry Participation Code Amendment (Code Review Programme) 2018.

14.26 Resolution of dispute about amount

- (1) The disputing **participant** and the **clearing manager** must attempt to resolve the dispute.

- (2) The **clearing manager** must revise the disputed amount and any other affected amount if, in time for the **clearing manager** to advise each **participant** of each amount owing and each amount payable 2 **business days** or more before the disputed amount is due to be paid or received by the disputing **participant**—

(a) the dispute is resolved by the parties advised of the dispute agreeing that information used to determine the amount is incorrect; and

(b) *[Revoked]*

(c) the **clearing manager** has received all information necessary to revise the amount and any other affected amount (including revised **volume information** if necessary).

- (3) Subject to clause 14.28, if the **participant** and the **clearing manager** do not resolve the dispute by the time referred to in subclause (2), the disputing **participant** must pay or receive the amount in accordance with clauses 14.31 and 14.34.

Clause 14.26(2): amended, on 24 March 2015, by clause 7(1) of the Electricity Industry Participation Code Amendment (Late and Revised Data) 2015.

Clause 14.26(2)(b): revoked, on 24 March 2015, by clause 7(2) of the Electricity Industry Participation Code Amendment (Late and Revised Data) 2015.

Clause 14.26(3): amended, on 24 March 2015, by clause 7(3) of the Electricity Industry Participation Code Amendment (Late and Revised Data) 2015.

14.27 Dispute about amount may be referred to Rulings Panel

- (1) If the dispute is not resolved within 15 **business days** after the date on which the **clearing manager** received notice of the dispute under clause 14.25(1), the disputing **participant** or the **clearing manager** may refer the dispute to the **Rulings Panel** for resolution.

- (2) The **Rulings Panel** may make such determination as it thinks fit.

- (3) The **Rulings Panel** must give notice of its determination to the parties to the dispute and affected **participants**.

Clause 14.27(1): amended, on 1 November 2018, by clause 101 of the Electricity Industry Participation Code Amendment (Code Review Programme) 2018.

14.28 Correction of information about amount as result of dispute

- (1) If a dispute (other than a dispute resolved by the time referred to in clause 14.26(2)) is resolved by the parties to the dispute agreeing, or the **Rulings Panel** determining, that information used to determine the amount is incorrect, the **clearing manager** and the **reconciliation manager** must correct the information as follows:

(a) if the information to be corrected is **volume information**, the information must be

- corrected in accordance with subclause (2):
- (b) if the information to be corrected is not **volume information**—
 - (i) the **clearing manager** must either correct the information, or advise the appropriate **market operation service provider** or the **Authority** so that the information may be corrected; and
 - (ii) if a **market operation service provider** or the **Authority** corrects the information, the **market operation service provider** or the **Authority**, as the case may be, must provide the corrected information to the **clearing manager**.
- (2) The **reconciliation manager** must correct **volume information** as follows:
- (a) if a revised **seasonal adjustment shape** must be issued in order for the **volume information** to be corrected—
 - (i) the **reconciliation manager** must provide each **reconciliation participant** whose **submission information** is required to be corrected with a revised **seasonal adjustment shape**; and
 - (ii) each **reconciliation participant** must provide corrected **submission information** to the **reconciliation manager** no later than 4 **business days** after being provided with the revised **seasonal adjustment shape**:
 - (b) if a revised **seasonal adjustment shape** is not required to be issued in order for the **volume information** to be corrected, each **reconciliation participant** whose **submission information** or **dispatchable load information** is required to be corrected must provide corrected **submission information** or **dispatchable load information** to the **reconciliation manager** no later than 4 **business days** after receiving notice of the resolution of the dispute:
 - (c) the **reconciliation manager** must provide the corrected **volume information** to the **clearing manager**.
- (3) If information is corrected under subclause (1) or (2), the **clearing manager** must advise the **Authority** and comply with any direction given by the **Authority** on the matter.
- (4) Without limiting subclause (3), a direction that the **Authority** gives under that subclause may include—
- (a) a direction to advise each **participant** of each amount owing and each amount payable by the **participant** by a date specified by the **Authority**; or
 - (b) a direction to conduct **washups** in accordance with subpart 6.

Clause 14.28(1): amended, on 24 March 2015, by clause 8(1) of the Electricity Industry Participation Code Amendment (Late and Revised Data) 2015.

Clause 14.28(2)(b): amended, on 1 November 2018, by clause 102 of the Electricity Industry Participation Code Amendment (Code Review Programme) 2018.

Clause 14.28(3): amended, on 24 March 2015, by clause 8(2) of the Electricity Industry Participation Code Amendment (Late and Revised Data) 2015.

Clause 14.28(4): inserted, on 24 March 2015, by clause 8(3) of the Electricity Industry Participation Code Amendment (Late and Revised Data) 2015.

Subpart 5—Payments

14.29 Payment of amounts payable

- (1) If the calculation under clause 14.22 provides for a **participant** to pay an amount to the

clearing manager, the **participant** must pay that amount to the **clearing manager** in accordance with clauses 14.31 and 14.32.

- (2) If the calculation under clause 14.22 provides for the **clearing manager** to pay an amount to a **participant**, the **clearing manager** must pay that amount to the **participant** in accordance with clause 14.34.

14.30 Prepayment of amounts payable

- (1) A **participant** may elect to pay an amount to the **clearing manager** before the **participant** incurs the amount owing to the **clearing manager**.
- (2) If a **participant** prepays an amount to the **clearing manager** under subclause (1),—
 - (a) the **participant** must advise the **clearing manager** of 1 or more **billing periods** to which the payment relates; and
 - (b) the **clearing manager** must deduct the amount paid by the **participant** from the amount advised to the **participant** as owing by the **participant** to the **clearing manager** under subpart 4.
- (3) Any amount paid to the **clearing manager** under this clause must not be returned to the **participant**, except as provided in subclause (4).
- (4) If an amount prepaid by a **participant** is more than the actual amount payable by the **participant** to the **clearing manager** for the relevant **billing periods**, the **clearing manager** must—
 - (a) apply the amount to the amount payable in the next **billing period**; or
 - (b) if the **participant** requests the **clearing manager** to pay the residual amount to the **participant** and satisfies the **clearing manager** that it will continue to comply with prudential requirements in Part 14A, pay the residual amount to the **participant** in accordance with clause 14.34.
- (5) The **clearing manager** must credit to a **participant** that has prepaid an amount under this clause all interest received by the **clearing manager** on the prepaid amount, less any applicable deduction for tax purposes.

14.31 Deadlines for payments

- (1) Subject to subclauses (3) and (4), each **participant** must pay the **clearing manager** the amount advised to the **participant** under subpart 4 as payable by the **participant** to the **clearing manager** by—
 - (a) 1300 hours on the 20th day of the month following the **billing period** in respect of which the amount was advised; or
 - (b) if that day is not a **business day**, 1300 hours on the next **business day**.
- (2) If the **clearing manager** does not advise a **participant** of an amount payable by the time specified in clause 14.18(2)(b)(i), payment may, if the **participant** so elects, be delayed for a period corresponding to the period of delay in advising the **participant** of the amount payable.
- (3) In the case of advice of an amount payable being delayed, the **clearing manager** must advise the **participant** of the new payment date.
- (4) If the **clearing manager** revises an amount advised to the **participant** 2 **business days** or more before the amount is due to be paid, the **participant** must pay the amount by the date for payment under subclause (1).

Clause 14.31(1)(a): amended, on 5 October 2017, by clause 498 of the Electricity Industry Participation Code Amendment (Code Review Programme) 2017.

Clause 14.31(2): amended, on 24 March 2015, by clause 9 of the Electricity Industry Participation Code Amendment (Late and Revised Data) 2015.

14.32 Methods of payment

- (1) Subject to subclause (2), each **participant** must pay the **clearing manager** in **cleared funds** into the **operating account**.
- (2) A **participant** may instruct the **clearing manager** to pay all or part of an amount payable by the **participant** under clause 14.31 from a **cash deposit** held by the **clearing manager** in respect of the **participant** in accordance with clause 14A.13.
- (3) The **clearing manager** is not required to comply with an instruction given under subclause (2) unless it is received at least 2 **business days** before the **participant** is required under clause 14.31 to pay the **clearing manager** the amount to which the instruction relates.
- (4) However, the **participant** may request that the **clearing manager** comply with an instruction received later than provided for in subclause (3), and the **clearing manager** may agree to comply with such an instruction.

Clause 14.32(3) and (4): inserted, on 24 March 2015, by clause 11 of the Electricity Industry Participation Code Amendment (Settlement and Prudential Security) 2014.

14.33 Allocation of payments

- (1) Subject to subpart 8, the allocation by the **clearing manager** of a payment received from a **participant** under this Part must be dealt with in accordance with this clause.
- (2) The **clearing manager** must hold each amount paid into the **operating account** by or on behalf of a **participant** in payment or part payment of an amount payable under this subpart upon trust for those persons that are entitled to receive payment from the **clearing manager**.
- (3) A **participant** may not direct the **clearing manager** to apply any funds paid under this Part other than in accordance with this clause.
- (4) The **clearing manager** must separately account for any amount received under clause 14.31 in respect of an amount referred to in clause 14.19(2)(h) and (i).

14.34 Payments by clearing manager

- (1) Subject to subparts 7 and 8, the **clearing manager** must pay each **participant** the amount advised to the **participant** under subpart 4 as payable by the **clearing manager** to the **participant** by 1600 hours on the final **business day** for payment under clause 14.31.
- (2) The **clearing manager** must pay each **participant** in **cleared funds**.
- (3) A **participant** may instruct the **clearing manager** to treat all or part of an amount payable to the **participant** under this clause as a **cash deposit** under Part 14A.
- (4) The **clearing manager** is not required to pay a **participant** under this clause if a **settlement default** is continuing in relation to the **participant**.
- (5) The **clearing manager** is not required to comply with an instruction given under subclause (3) unless it is received at least 2 **business days** before the **participant** is required under clause 14.31 to pay the **clearing manager** the amount to which the instruction relates.

- (6) However, the **participant** may request that the **clearing manager** comply with an instruction received later than provided for in subclause (5), and the **clearing manager** may agree to comply with such an instruction.

Clause 14.34(5) and (6): inserted, on 24 March 2015, by clause 12 of the Electricity Industry Participation Code Amendment (Settlement and Prudential Security) 2014.

14.34A Payment of residual funds from operating accounts

- (1) In this clause,—
- (a) applicable period means the period from the last date the **clearing manager** determined the amount of residual funds to be paid to each **participant** under subclause (3), if applicable, up to the date the **clearing manager** determines the amount of residual funds to be paid to each **participant** under subclause (3);
 - (b) residual funds means any monies left in the **clearing manager's operating accounts** after all amounts owed by the **clearing manager** have been paid in accordance with this Part, less—
 - (i) any applicable deduction for tax purposes; and
 - (ii) any amounts that are allocated to be paid to **participants** in accordance with this Part that have not yet been paid; and
 - (iii) any amounts required to pay any bank fees due for the next two months for the **operating account**; and
 - (iv) any amounts required to maintain a positive balance in each **operating account** at a level that the **clearing manager** considers is reasonably prudent.
- (2) The **clearing manager** may use monies in the **operating accounts**, that are not paid or due to be paid to **participants** in accordance with this Part, to pay any bank fees due or applicable tax owing for the **operating accounts**.
- (3) The **clearing manager** will determine the amount of residual funds to be paid to each **participant** in accordance with subclause (4) as follows:
- (a) by determining the amount of residual funds available in its **operating accounts**;
 - (b) by identifying the **participants** that the **clearing manager** has paid in accordance with clause 14.20(2)(a), other than **grid owners**, in the applicable period;
 - (c) by allocating the residual funds available to the **participants** identified under paragraph (b), in direct proportion to the amount the **clearing manager** has paid each **participant** in the applicable period compared to the total amount the **clearing manager** has paid all **participants** in accordance with clause 14.20(2)(a), other than **grid owners**, in that period;
 - (d) by deducting, from any residual funds allocated to a defaulting **participant** under paragraph (c), any amount the **clearing manager** sets-off against the unpaid amount payable by the defaulting **participant** to the **clearing manager** under clause 14.44(1)(c);
 - (e) by rounding down the amount allocated to each **participant** to the nearest cent.
- (4) At least once in each six-month period, but no later than 1600 hours on the final **business day** in the months of March and September, the **clearing manager** must—
- (a) advise each **participant** that the **clearing manager** has paid in accordance with clause 14.20(2)(a) in the **applicable period**, other than **grid owners**, of the amount of residual funds to be paid to that **participant**, as determined under subclause (3); and
 - (b) pay the residual funds to each **participant** in accordance with subclause (3).

Clause 14.34A: inserted, on 1 March 2024, by clause 93 of the Electricity Industry Participation Code Amendment (Code Review Programme) 2024.

14.35 Payment of residual loss and constraint excess

Each **grid owner** must treat **residual loss and constraint excess** paid to it under this Part as **loss and constraint excess**.

14.35A Allocation and payment of settlement residue by grid owner

- (1) Each **grid owner** must allocate and pay any **settlement residue** to its customers on a monthly basis in accordance with a methodology developed under subclause (2), or if the **grid owner is Transpower**, subclause (3), subject to anything to the contrary in a **transmission agreement** or agreement referred to in clause 12.49(1).
- (2) Each **grid owner** must develop a methodology for allocating **settlement residue** to its customers such that the amount allocated to any customer is in proportion to that customer's share of the total charges for using the **grid owner's** part of the **grid**.
- (3) **Transpower** must develop a methodology for allocating **settlement residue** to its customers such that the amount to be allocated to any customer is calculated by—
 - (a) dividing the **settlement residue** into portions related to—
 - (i) each connection asset; and
 - (ii) the interconnection assets in each modelled region under the simple Method; and
 - (b) allocating **settlement residue** related to each connection asset to the **designated transmission customers** connected to it; and
 - (c) allocating the **settlement residue** related to each modelled region under the simple method to the beneficiaries of transmission investments in the modelled region under the simple method.
- (4) A **grid owner** may adjust any payment made under subclause (1) to correct for a previous overpayment or underpayment under that subclause.
- (5) A payment required under subclause (1) may be met by way of a credit against any amount owed to the **grid owner** by the customer.
- (6) **Transpower** must disclose monthly to a **distributor** the following information about any payment made to the **distributor** under subclause (1)—
 - (a) the **connection location** it relates to; and
 - (b) where applicable, whether it relates to **offtake** or **grid injection**.
- (7) In subclause (3)—
 - (a) “beneficiaries”, “connection asset”, “interconnection asset”, “modelled region”, “simple method” and “transmission investments” have the meanings set out in the **transmission pricing methodology**; and
 - (b) whether a **designated transmission customer** is “connected to” a connection asset is determined under the **transmission pricing methodology**.
- (8) This clause applies to **settlement residue** paid to a **grid owner** in respect of any **trading period** on or after 1 April 2023.

Clause 14.35A: inserted, on 1 April 2023, by clause 9 of the Electricity Industry Participation Code Amendment (Settlement Residual Allocation Methodology) 2022.

Clause 14.35A(1): amended, on 1 October 2023, by clause 39 of the Electricity Industry Participation Code Amendment (Default Transmission Agreement) 2023.

Subpart 6—Washups

14.36 Clearing manager to conduct washups

If the **clearing manager** receives corrected information in accordance with clauses 8.68, 8.69, 15.20C(b), 15.26(4), or clause 28 of Schedule 15.4, it must conduct **washups** and advise **participants** of amounts owing in accordance with this subpart.

Clause 14.36: amended, on 24 March 2015, by clause 10 of the Electricity Industry Participation Code Amendment (Late and Revised Data) 2015.

14.37 Clearing manager to advise participants of washup amounts

The **clearing manager** must advise relevant **participants** of amounts owing in respect of **washup** amounts in accordance with subpart 4 and clauses 14.38 to 14.40, except that the **clearing manager** must, if requested by a **participant** affected by the **washup**, issue corrected information covered by the **washup** to the **participant**.

14.38 Washup amounts

- (1) All **washup** amounts and interest accrued in accordance with subclause (2) must be expressed as an amount owing by the **participant** to the **clearing manager** or an amount owing by the **clearing manager** to the **participant** in respect of the current **billing period**.
- (2) Daily interest (less any deduction for resident withholding tax) on the **washup** amount, calculated at the **bank bill bid rate**, accrues from the date that payment of the amount based on the incorrect information to which the **washup** relates was due as set out in clauses 14.31 and 14.34 (as applicable) until the date of advice of the revised **washup** amount in accordance with clause 14.18, and must be compounded at the end of each calendar month.

14.39 Washups for grid owners

If a **washup** has occurred due to incorrect **consumption information** being used to determine amounts owing in accordance with subpart 4 that affects **grid owners**, the **clearing manager** must credit or debit a **washup** amount to or from each **grid owner** as follows:

- (a) if a **grid owner's washup** amount is a credit, the **clearing manager** must add the credit to any amount owing to the **grid owner** in accordance with clause 14.16(7) in respect of the current **billing period**;
- (b) if a **grid owner's washup** amount is a debit, the **clearing manager** must subtract the debit from any amount owing to the **grid owner** in accordance with clause 14.16(7) in respect of the current **billing period**;
- (c) if the **washup** amount is greater than the amount owing, the **clearing manager** must advise the **grid owner** of any amount owing for the **washup** amount concurrently with advising **participants** of any amount owing under clause 14.18, and payment of the **washup** amount must be made by the **grid owner** by the time for payment set out in clause 14.31;
- (d) daily interest (less any deduction for resident withholding tax) on the **washup** amount, calculated at the **bank bill bid rate**, must be debited or credited (as the

case may be) to the amount owing to the **grid owner** in accordance with clause 14.16(7), and accrues from the date that payment based on the incorrect information to which the **washup** relates was made until the date of advice in accordance with clause 14.18 resulting in the **grid owner's washup** amount, and must be compounded at the end of each calendar month.

14.40 Payment where no longer participant

- (1) Despite clauses 14.38 and 14.39, if a **washup** amount affects a person that is no longer a **participant**, the **clearing manager** must advise the person of the **washup** amount owing and payable in accordance with clauses 14.31 and 14.32.
- (2) The person remains liable for outstanding obligations in accordance with section 30(3) of the **Act**.
- (3) Daily interest (less any deduction for resident withholding tax) on the **washup** amount, calculated at the **bank bill bid rate**, must be added to the **washup** amount and accrues from the date that payment of the amount based on the incorrect information to which the **washup** relates was due as set out in 14.31 and 14.34 (as applicable) until the date of advice of the revised **washup** amount in accordance with clause 14.18, and must be compounded at the end of each calendar month.

Subpart 7—Events of default

Types of default

14.41 Definition of an event of default

- (1) Each of the following events constitutes an **event of default**:
 - (a) failure of a **participant** to provide security for the minimum amount required in accordance with clause 14A.6:
 - (b) a **settlement default**:
 - (c) any action taken for, or with a view to, the declaration of a **participant** that is required to comply with Part 14A as a corporation at risk under the Corporations (Investigation and Management) Act 1989:
 - (d) appointment of a statutory manager in respect of **participant** that is required to comply with Part 14A under the Corporations (Investigation and Management) Act 1989 (or a recommendation or submission is made by a person to the Financial Markets Authority supporting such an appointment):
 - (e) appointment of a person under section 19 of the Corporations (Investigation and Management) Act 1989 to investigate the affairs or run the **business** of a **participant** that is required to comply with Part 14A:
 - (f) if a **participant** that is required to comply with Part 14A is (or admits that it is or is deemed under any applicable law to be) unable to pay its debts as they fall due or is otherwise insolvent, or stops or suspends, or a moratorium is declared on, payment of its indebtedness generally, or makes or commences negotiations or takes any other steps with a view to making any assignment or composition with, or for the benefit of, its creditors, or any other arrangement for the rescheduling of its indebtedness or otherwise with a view to avoiding, or in expectation of its

- inability to pay, its debts:
- (g) a holder of a security interest or other encumbrancer taking possession of, or a receiver, manager, receiver and manager, liquidator, provisional liquidator, trustee, statutory or official manager or inspector, administrator or similar officer being appointed in respect of the whole or any part of the assets of a **participant** that is required to comply with Part 14A or if the **participant** requests that such an appointment be made:
 - (h) termination of a **trader's distributor agreement** with a **distributor** because of a **serious financial breach** if—
 - (i) the **trader** continues to have a customer or customers purchasing **electricity** from the **trader** on the **distributor's local network** or **embedded network**; and
 - (ii) there are no unresolved disputes between the **trader** and the **distributor** in relation to the termination; and
 - (iii) the **distributor** has not been able to remedy the situation in a reasonable time; and
 - (iv) the **distributor** gives notice to the **Authority** that this subclause applies:
 - (i) if the **clearing manager** is prohibited from establishing or continuing a business relationship with a **participant** under the Anti-Money Laundering and Countering Financing of Terrorism Act 2009.
- (2) If a **distributor**, having given notice under subclause (1)(h)(iv), considers that an **event of default** no longer exists, the **distributor** must advise the **Authority** that it considers that the **event of default** has been remedied.

Clause 14.41(h): inserted, on 24 March 2015, by clause 13 of the Electricity Industry Participation Code Amendment (Settlement and Prudential Security) 2014.

Clause 14.41(h): amended, on 24 March 2015, by clause 11 of the Electricity Industry Participation Code Amendment (Late and Revised Data) 2015.

Clause 14.41(1)(f): amended, on 7 September 2020, by clause 9 of the Electricity Industry Participation Code Amendment (Improving Trader Default Process) 2020.

Clause 14.41(1)(h): amended, on 20 July 2020, by clause 8 of the Electricity Industry Participation Code Amendment (Default Distributor Agreement) 2020.

Clause 14.41(1)(h)(i): amended, on 1 November 2018, by clause 103 of the Electricity Industry Participation Code Amendment (Code Review Programme) 2018.

Clause 14.41(1)(h)(i) and (iv): amended, on 1 February 2016, by clause 91(1) and (2) of the Electricity Industry Participation Code Amendment (Code Review Programme) 2015.

Clause 14.41(1)(h)(iv): inserted, on 1 March 2024, by clause 94 of the Electricity Industry Participation Code Amendment (Code Review Programme) 2024.

Clause 14.41(2): inserted, on 1 February 2016, by clause 91(3) of the Electricity Industry Participation Code Amendment (Code Review Programme) 2015.

Procedure for event of default

14.42 Clearing manager to advise Authority of anticipated event of default

- (1) If the **clearing manager** believes that an **event of default** is likely to occur, the **clearing manager** must advise the **Authority** so that the **Authority** can consider an appropriate course of action.

- (2) If the **clearing manager**, having advised the **Authority** under subclause (1), no longer believes that an **event of default** is likely to occur, the **clearing manager** must advise the **Authority** that it no longer believes that the **event of default** is likely to occur.

Clause 14.42(2): inserted, on 1 February 2016, by clause 92 of the Electricity Industry Participation Code Amendment (Code Review Programme) 2015.

14.43 Procedure upon event of default

- (1) If an **event of default** occurs in relation to a **participant**, the **participant** must immediately advise the **clearing manager** and the **Authority** of the **event of default**.
- (2) Despite subclause (1), a **participant** is not required to advise the **clearing manager** or the **Authority** if the **participant** would breach section 36 of the Corporations (Investigation and Management) Act 1989 by advising the **clearing manager** or the **Authority**.
- (3) If subclause (2) applies, the **participant** must seek the consent of the Registrar of Companies or the Financial Markets Authority (as applicable) to disclose the matter to the **clearing manager** and the **Authority**.
- (3A) If a **participant**, having advised of an **event of default** under subclause (1), considers that the **event of default** has been remedied, the **participant** must advise the **clearing manager** that it considers that the **event of default** has been remedied.
- (3B) If the **clearing manager** has been advised under subclause (3A) that the **participant** considers that an **event of default** has been remedied, the **clearing manager** must—
- decide whether it agrees that the **event of default** has been remedied; and
 - if it agrees, advise the **Authority** that it considers that the **event of default** has been remedied.
- (4) If the **clearing manager** becomes aware that an **event of default** under paragraphs (a) to (g) of clause 14.41 has occurred and is continuing in relation to a **participant**, the **clearing manager** must—
- advise the **Authority** that the **event of default** has occurred; and
 - if the **participant** has not advised the **clearing manager** of the **event of default**, advise the defaulting **participant** that the **event of default** has occurred.
- (4A) If the **clearing manager**, having advised of an **event of default** under subclause (4), considers that the **event of default** has been remedied, the **clearing manager** must advise the **Authority** that it considers that the **event of default** has been remedied.

- (5) *[Revoked]*

Clause 14.43(3A) and (3B): inserted, on 1 February 2016, by clause 93(1) of the Electricity Industry Participation Code Amendment (Code Review Programme) 2015.

Clause 14.43(4): substituted, on 24 March 2015, by clause 14(1) of the Electricity Industry Participation Code Amendment (Settlement and Prudential Security) 2014.

Clause 14.43(4A): inserted, on 1 February 2016, by clause 93(2) of the Electricity Industry Participation Code Amendment (Code Review Programme) 2015.

Clause 14.43(5): revoked, on 24 March 2015, by clause 14(2) of the Electricity Industry Participation Code Amendment (Settlement and Prudential Security) 2014.

Remedies and rights of recovery

14.44 Event of default gives clearing manager remedies

- (1) If an **event of default** has occurred, the **clearing manager** has the power to exercise, as appropriate, all or any of the following remedies without prejudice to any other remedy

it may have at law:

- (a) apply the balance of the **cash deposit** of the defaulting **participant** in accordance with clause 14A.13(a);
 - (b) make a demand under a guarantee, letter of credit, or bond provided under Part 14A in respect of the defaulting **participant**;
 - (c) if the defaulting **participant** has not paid an amount due under this Part by the due date for payment, set-off any amount payable by the **clearing manager** to the defaulting **participant** against the unpaid amount payable by the defaulting **participant** to the **clearing manager**;
 - (d) take possession of any **FTR** held by the defaulting **participant** in accordance with clause 14.47.
- (2) If an **event of default** is continuing at the expiry of the **participant's** post-default exit period registered under clause 14A.22,—
- (a) the **clearing manager** must cancel a **hedge settlement agreement** to which the defaulting **participant** is a party in accordance with clause 14.48;
 - (b) the **Authority** may direct a **grid owner** or **distributor** to exercise any contractual right the **grid owner** or **distributor** has to **electrically disconnect** a defaulting **participant** that is a **direct purchaser** in accordance with clause 14.49.

Clause 14.44(2)(b): amended, on 5 October 2017, by clause 499 of the Electricity Industry Participation Code Amendment (Code Review Programme) 2017.

14.45 Remedies for settlement default

If the **clearing manager** elects to exercise any of the remedies specified in clause 14.44 in the event of a **settlement default**, the **clearing manager** must exercise the remedies in the following order:

- (a) set-off the amount payable by the **clearing manager** to the defaulting **participant** against any amount that is payable by the defaulting **participant** to the **clearing manager** in respect of the current **billing period** or any other **billing period**;
- (b) apply the balance of the **cash deposit** of the defaulting **participant**;
- (c) if the amounts set-off or applied under paragraphs (a) and (b) are not sufficient to remedy the default,—
 - (i) make a demand under a guarantee, letter of credit, or bond provided under Part 14A in respect of the defaulting **participant**;
 - (ii) take possession of any **FTR** held by the defaulting **participant** in accordance with clause 14.47.

14.46 Remedies for other types of default

If an **event of default** other than a **settlement default** occurs in relation to a **participant**, the **clearing manager** must exercise all or any of the remedies specified in clause 14.44 to ensure that it has sufficient funds for the next settlement date.

14.47 Application to take possession of FTR

- (1) The **clearing manager** on application to the **FTR manager** is entitled to be registered on the **FTR register** as the holder of any **FTR** that the **clearing manager** takes possession of under clause 14.44(1)(d) without any further authorisation than this

subclause.

- (2) If the **FTR hedge values** or estimated **FTR hedge values** of the **FTRs** held by the defaulting **participant** exceed the amount required to remedy the **event of default**, the **clearing manager** may exercise its discretion in deciding which **FTRs** are transferred to the **clearing manager**.
- (3) If the amount received by the **clearing manager** on settlement or sale of an **FTR** taken possession of under clause 14.44(1)(d) exceeds the amount required to remedy the **event of default**, the **clearing manager** must repay the excess amount to the defaulting **participant**.
- (4) If the **clearing manager** holds an **FTR** in respect of which an amount would be owing if the **FTR** was held by another person, no amount is owing by the **clearing manager**.

14.48 Cancellation of hedge settlement agreement in event of default

- (1) If the defaulting **participant** is a party to a **hedge settlement agreement** and the **event of default** is continuing at the expiry of the **participant's** post-default exit period registered under clause 14A.22, the **clearing manager** must cancel the **hedge settlement agreement** on the first **business day** after the expiry of the **participant's** post-default exit period.
- (2) The **clearing manager** must give written notice to the parties to the **hedge settlement agreement** if a **hedge settlement agreement** is cancelled under this clause.

14.49 Electrical disconnection of direct purchaser

- (1) Each **direct purchaser** must at all times ensure that the terms of each of its contracts that provide for the **electrical connection** of the **direct purchaser** to a **network** permit the relevant **grid owner** or **distributor** to **electrically disconnect** the **direct purchaser** on the direction of the **Authority** if an **event of default** occurs in relation to the **direct purchaser** and is continuing at the expiry of its post-default exit period registered under clause 14A.22.
- (2) Each **grid owner** or **distributor** must at all times ensure that the terms of each of its contracts that provide for the **electrical connection** of a **direct purchaser** to a **network** permit the **grid owner** or **distributor** to **electrically disconnect** the **direct purchaser** on the direction of the **Authority** if an **event of default** occurs in relation to the **direct purchaser** and is continuing at the expiry of its post-default exit period registered under clause 14A.22.
- (3) If an **event of default** occurs in relation to a **direct purchaser** and is continuing at the expiry of the **direct purchaser's** post-default exit period registered under clause 14A.22, the **Authority** may direct a **grid owner** or **distributor** to exercise any contractual right the **grid owner** or **distributor** has to **electrically disconnect** the defaulting **direct purchaser**.
- (4) A **grid owner** or **distributor** that receives a direction under subclause (3) must comply with the direction.

Clause 14.49 Heading: amended, on 5 October 2017, by clause 500(1) of the Electricity Industry Participation Code Amendment (Code Review Programme) 2017.

Clause 14.49(1): amended, on 5 October 2017, by clause 500(2) and (3) of the Electricity Industry Participation Code Amendment (Code Review Programme) 2017.

Clause 14.49(2): amended, on 5 October 2017, by clause 500(2) and (3) of the Electricity Industry Participation Code Amendment (Code Review Programme) 2017.

Clause 14.49(3): amended, on 5 October 2017, by clause 500(3) of the Electricity Industry Participation Code Amendment (Code Review Programme) 2017.

14.50 Clearing manager to exercise rights to recover amounts outstanding

The **clearing manager** must exercise such rights, including those rights under the **Act** and this Code, as is reasonable to recover any amounts outstanding from a defaulting **participant**.

14.51 Participants assigned or subrogated to all clearing manager's rights of recovery

- (1) If a **participant's** default means that the **clearing manager** is unable to pay **participants** the full outstanding amount that would otherwise be payable to them so that any amount paid to **participants** is reduced under subpart 8, the **participants** are entitled to be assigned or subrogated to the rights of the **clearing manager** in respect of amounts payable to the **clearing manager** by the relevant defaulting **participant** which, if paid, would have been required to be held on trust by the **clearing manager** for the **participants** in accordance with this Code.
- (2) The **clearing manager** must do all that is reasonably necessary, including the granting of a power of attorney in favour of the **participants**, to assist the **participants** in the exercise of the rights.
- (3) The **participants** may, in the name of the **clearing manager** (if requested),—
 - (a) take any step to enforce repayment or exercise any other rights of the **clearing manager** in respect of money for the time being due to the **clearing manager**—
 - (i) from a defaulting **participant**; or
 - (ii) from a guarantor of the defaulting **participant**; or
 - (iii) from any person that has provided a letter of credit or bond in favour of the **clearing manager** in respect of the defaulting **participant**; or
 - (iv) in respect of any other security held by the **clearing manager** in respect of the defaulting **participant**; and
 - (b) directly or indirectly, prove in, claim, share in, or receive the benefit of any distribution, dividend, or payment arising out of—
 - (i) any insolvency of a defaulting **participant**; or
 - (ii) a guarantor of the defaulting **participant**; or
 - (iii) any person that has provided a letter of credit or bond in favour of the **clearing manager** in respect of the defaulting **participant**; or
 - (iv) any other security held by the **clearing manager** in respect of the defaulting **participant**.

14.52 Rights of participants to exercise rights

- (1) Any 1 or more **participants** is entitled to exercise rights under clause 14.51, if—
 - (a) the **clearing manager** has not, within 3 **business days** of receiving notice of, or otherwise becoming aware of, the occurrence of an **event of default**, taken any action under clauses 14.44 to 14.46; or
 - (b) the **clearing manager** has failed within 2 months of an **event of default** to collect all amounts due from the defaulting **participant**.

- (2) Nothing in subclause (1) or this subpart limits the statutory right of the **clearing manager** to apply to the Court for the appointment of a receiver, interim liquidator, or liquidator.

Publication of information about event of default

14.53 Authority may publish information about event of default

- (1) The **Authority** may **publish** information about an **event of default** if the **Authority** considers it is appropriate.
- (2) If an **event of default** results in a reduction in payments under subpart 8, the **Authority** must **publish** information about the following:
- (a) the nature of the **event of default**;
 - (b) the extent of the **event of default**;
 - (c) the identity of the defaulting **participant**.

Clause 14.53 Heading: amended, on 5 October 2017, by clause 501(1) of the Electricity Industry Participation Code Amendment (Code Review Programme) 2017.

Clause 14.53(1) and (2): amended, on 5 October 2017, by clause 501(2) of the Electricity Industry Participation Code Amendment (Code Review Programme) 2017.

Subpart 8—Payments in event of settlement default

14.54 Application of this subpart

- (1) This subpart applies if—
- (a) a **participant** commits a **settlement default**; and
 - (b) the amount received from the defaulting **participant** and recovered or set-off under clause 14.44 by 1500 hours on the final day for payment under clause 14.31 is less than the amount payable by the **participant** to the **clearing manager**.
- (2) In this subpart a reference to 1 or more general amounts is a reference to any amount that is not required to be applied to the settlement of **FTRs** or paid to the **grid owner** as **residual loss and constraint excess**.

14.55 Allocation of shortfall to settlement of general amounts and FTRs

- (1) The **clearing manager** must allocate any shortfall as a result of a **settlement default** to adjust the settlement of general amounts and **FTRs** in accordance with this clause.
- (2) The shortfall is—
- (a) the amount payable by the defaulting **participant** to the **clearing manager** under subpart 5; minus
 - (b) any amount received from the defaulting **participant** and recovered or set-off under clause 14.44.
- (3) In respect of each defaulting **participant**, the amount of the shortfall that must be allocated to adjust the settlement of general amounts is the total shortfall, less the amount of the shortfall that must be allocated to adjust the settlement of **FTRs** in accordance with subclause (4).
- (4) In respect of each defaulting **participant**, the amount of the shortfall that must be allocated to adjust the settlement of **FTRs** is determined in accordance with the following formula:

$$X_{FTR} = X_{TOT} * (O_{FTR}/O_{TOT})$$

where

X_{FTR} is the amount of the shortfall that must be allocated to adjust the settlement of **FTRs**

X_{TOT} is the amount of the total shortfall

O_{FTR} is the total amount owing by the defaulting **participant** to the **clearing manager** in respect of **FTRs** as specified under clause 14.19(2)(h) and (i)

O_{TOT} is the total amount owing by the defaulting **participant** to the **clearing manager** as specified under clause 14.19(3)

- (5) If the total amount owing by a defaulting **participant** as specified under clause 14.19(3) includes an amount owing in respect of the assignment of any **FTR** under clause 14.19(2)(i) that relates to a future **billing period** or **billing periods**, a portion of the amount of the shortfall that must be allocated to adjust the settlement of **FTRs** under subclause (4) must be allocated to each future **billing period** in accordance with the following formula:

$$F_{FTR} = X_{FTR} * (O_{FTR (future)}/O_{FTR})$$

where

F_{FTR} is the amount of the shortfall that must be allocated to adjust the settlement of **FTRs** in the future **billing period**

X_{FTR} is the amount of the shortfall that must be allocated to adjust the settlement of **FTRs**, calculated under subclause (4)

$O_{FTR (future)}$ is the amount owing by the defaulting **participant** to the **clearing manager** in respect of the assignment of an **FTR** under clause 14.19(2)(i) that relates to the future **billing period**

O_{FTR} is the total amount owing by the defaulting **participant** to the **clearing manager** in respect of **FTRs** as specified under clause 14.19(2)(h) and (i)

Clause 14.55(4): amended, on 24 March 2015, by clause 15 of the Electricity Industry Participation Code Amendment (Settlement and Prudential Security) 2014.

14.56 Calculation of revised amount owing for general amounts

- (1) The **clearing manager** must apply any amount available for the settlement of general amounts in accordance with the following order of priority:
- (a) to satisfy any liability to pay **GST** and other governmental charges or levies, that are payable by the **clearing manager** in respect of the amounts owing and payable under subparts 4 to 6, taking into account any **GST** input tax credits available to the **clearing manager** in respect of payments under paragraphs (b) to (e):
 - (ab) *[Revoked]*
 - (b) to satisfy any amounts owing to the **system operator** for **ancillary services** under clauses 8.6, 8.31(1)(a), and 8.55 to 8.67:

- (i) the **system operator** for **ancillary services** under clauses 8.6, 8.31(1)(a), and 8.55 to 8.67:
 - (ii) an **extended reserve provider** for **extended reserve** under clauses 8.55(2) and 8.68(4):
 - (c) to satisfy any amount of **loss and constraint excess** to be applied to the settlement of **FTRs** under clause 14.16(4) or (5):
 - (d) to satisfy any amount owing to each **grid owner** for any **loss and constraint excess** in accordance with clause 14.16(7)(a):
 - (e) to satisfy any other general amount owing by the **clearing manager** to a **participant**.
- (2) If there is an insufficient amount available for the settlement of general amounts, the **clearing manager** must calculate the revised amounts owing by the **clearing manager** to **participants** in respect of general amounts as follows:
- (a) first apply the full amount available to satisfy each amount owing in the order of priorities in subclause (1):
 - (b) if there is an insufficient amount to satisfy the full amount owing under any of paragraphs (a) to (e) of subclause (1), calculate the revised amount owing to each **participant** under that paragraph according to the following formula:

$$AO_{CM (revised)} = AO_{CM (general)} \times (A_{general}/R_{general})$$

where

$AO_{CM (revised)}$ is the revised amount owing by the **clearing manager** to the **participant** in respect of the general amounts

$AO_{CM (general)}$ is the amount owing by the **clearing manager** to the **participant** in respect of that **billing period** under the relevant paragraph in subclause (1)

$A_{general}$ is the total amount available for the settlement of amounts owing by the **clearing manager** in the relevant **billing period** under the relevant paragraph in subclause (1)

$R_{general}$ is the sum of all amounts required to settle those amounts in respect of the **billing period**

Clause 14.56(1)(ab): inserted, on 24 March 2015, by clause 30 of the Electricity Industry Participation Code Amendment (Extended Reserve) 2014.

Clause 14.56(1)(ab): revoked, on 19 January 2017, by clause 15(1) of the Electricity Industry Participation Code Amendment (Extended Reserve) 2016.

Clause 14.56(1)(b): replaced, on 19 January 2017, by clause 15(2) of the Electricity Industry Participation Code Amendment (Extended Reserve) 2016.

Clause 14.56(1)(b): amended, on 21 December 2021, by clause 38 of the Electricity Industry Participation Code Amendment (Automatic Under-Frequency Load Shedding Systems) 2021.

14.57 Calculation of revised amount owing for FTR amounts

- (1) The **clearing manager** must apply any amount available for the settlement of **FTRs** in accordance with the following order of priority:
 - (a) to satisfy any amount owing to a **participant** in respect of **FTRs**:
 - (b) to satisfy any amount owing to each **grid owner** for any **residual loss and**

constraint excess under clause 14.16(7)(b).

- (2) If there is an insufficient amount available for the settlement of **FTRs**, the **clearing manager** must calculate the revised amount owing in respect of **FTRs** as follows:
- (a) first apply the amount available for the settlement of **FTRs** in the relevant **billing period** to satisfy each amount owing to a **participant** in respect of an **FTR**:
 - (b) if there is an amount remaining for the settlement of **FTRs** in the relevant **billing period** after the **clearing manager** has satisfied each amount owing to a **participant** in respect of an **FTR**, the **clearing manager** must allocate that amount to each **grid owner** under clause 14.16(7)(b):
 - (c) if there is an insufficient amount to satisfy each amount owing under paragraph (a), the **clearing manager** must adjust each amount owing to a **participant** in respect of an **FTR** according to the following formula:

$$AO_{CM (revised)} = AO_{CM (FTRs)} * (C_{FTR}/FTR_{required})$$

where

$AO_{CM (revised)}$ is the revised amount owing by the **clearing manager** to the **participant** in respect of **FTRs**

$AO_{CM (FTRs)}$ is the amount advised to the **participant** under clause 14.20 as being owing to the **participant** in respect of that **billing period** in respect of an amount specified in clause 14.20(2)(h) or (i)

C_{FTR} is the total amount available for the settlement of **FTRs** in the relevant **billing period**

$FTR_{required}$ is the sum of all amounts required to settle **FTRs** in respect of the **billing period**

14.58 Calculation of scaled amount payable

The **clearing manager** must calculate the scaled amount payable for each **participant** to which an amount is payable by the **clearing manager** under subpart 5 in accordance with the following formula:

$$AP_{CM (scaled)} = AO_{CM (revised)} - AOP + P$$

where

$AP_{CM (scaled)}$ is the scaled amount payable by the **clearing manager** to the **participant**

$AO_{CM (revised)}$ is the sum of the revised amounts owing by the **clearing manager** to the **participant**, calculated under clauses 14.56 and 14.57

AOP is the sum of the amounts owing by the **participant** to the **clearing manager**, calculated under clause 14.19

P is any amount payable by the **participant** under clause 14.31 and, in the case of a defaulting **participant**, that amount minus any amount set-off under clause 14.44(1)(c)

Clause 14.58: amended, on 24 March 2015, by clause 16 of the Electricity Industry Participation Code Amendment (Settlement and Prudential Security) 2014.

14.59 Calculation of revised amount payable

- (1) If the application of the formula in clause 14.58 results in a scaled amount payable that is positive or 0 for every **participant** to which an amount is payable by the **clearing manager**, the scaled amount payable by the **clearing manager** to a **participant** is the revised amount payable by the **clearing manager** under clause 14.60.
- (2) *[Revoked]*
- (3) *[Revoked]*
- (4) If the application of the formula in clause 14.58 results in a scaled amount payable that is negative for 1 or more **participants** to which an amount is payable by the **clearing manager**, the **clearing manager** must calculate the revised amount payable by the **clearing manager** under clause 14.60 as follows:
 - (a) for each **participant** for which the scaled amount payable is negative, set the revised amount payable for the **participant** to 0:
 - (b) for each **participant** for which the scaled amount payable is positive, calculate the revised amount payable to the **participant** in accordance with the following formula:

$$AP_{CM (revised)} = AP_{CM (scaled)} + AP_{negative} (AO_{CM (revised)} / AO_{positive})$$

where

$AP_{CM (revised)}$ is the revised amount payable by the **clearing manager** to the **participant**

$AP_{CM (scaled)}$ is the scaled amount payable by the **clearing manager** to the **participant**, calculated under clause 14.58

$AP_{negative}$ is the sum of all scaled amounts payable by the **clearing manager** to the **participant** for every **participant** for which the scaled amount payable is negative

$AO_{CM (revised)}$ is the sum of the revised amounts owing by the **clearing manager** to the **participant**, calculated under clauses 14.56 and 14.57

$AO_{positive}$ is the sum of all revised amounts owing by the **clearing manager** to a **participant** for every **participant** for which the scaled amount payable is positive

- (5) If the application of the formula in subclause (4)(b) results in a **participant** having a revised amount payable that is negative, the **clearing manager** must recalculate the revised amount payable for each **participant** under subclause (4) using the revised amount payable by the **clearing manager** to the **participant** as the scaled amount payable by the **clearing manager** to the **participant**.

Clause 14.59(2): amended, on 24 March 2015, by clause 17(1) of the Electricity Industry Participation Code Amendment (Settlement and Prudential Security) 2014.

Clause 14.59(2) and (3): revoked, on 24 March 2015, by clause 12(1) of the Electricity Industry Participation Code Amendment (Late and Revised Data) 2015.

Clause 14.59(4): amended, on 24 March 2015, by clause 12(2) of the Electricity Industry Participation Code Amendment (Late and Revised Data) 2015.

Clause 14.59(4)(b): amended, on 24 March 2015, by clause 17(2) and (3) of the Electricity Industry Participation Code Amendment (Settlement and Prudential Security) 2014.

14.60 Payment of revised amount payable

The **clearing manager** must pay each **participant** the revised amount payable in accordance with clause 14.34 as if references to the amount payable were references to the revised amount payable.

14.61 Payment by participant with negative scaled amount payable

- (1) If the application of the formula in clause 14.58 results in a scaled amount payable for a **participant** that is negative, the **participant** must pay an amount that is equal to the absolute value of the scaled amount payable in accordance with this clause.
- (2) The **clearing manager** must advise the **participant** of the amount payable.
- (3) The **participant** must pay the amount payable to the **clearing manager** by 1300 hours on the next **business day** after the day on which the **clearing manager** advises the **participant** of the amount.
- (4) Clause 14.32 applies to a payment under this clause.
- (5) If the **clearing manager** receives further funds from the defaulting **participant**, the **clearing manager** may revise or cancel the amount payable under this clause to reflect the need for the amount payable.

14.62 Application of payment by participant with negative scaled amount payable

- (1) The **clearing manager** must allocate the funds received under clause 14.61 to each **participant** for which the scaled amount payable is positive.
- (2) The amount allocated to each **participant** under this clause is the difference between the scaled amount payable and revised amount payable for the **participant**.
- (3) The **clearing manager** must pay each **participant** the amount allocated under this clause by 1600 hours on the day that funds are received under clause 14.61.
- (4) If there are insufficient funds to pay each **participant** the amount allocated under this clause, the **clearing manager** must adjust the amount payable for each **participant** based on the proportion that the amount payable by the **clearing manager** to the **participant** bears to the total amount payable to all **participants** under this clause.

14.63 Further funds paid according to priority

- (1) As further funds are received or recovered from a defaulting **participant** by the **clearing manager**, those funds must be allocated to the settlement of general amounts and **FTRs** and paid in accordance with this subpart as if—
 - (a) the further funds had been paid by the defaulting **participant** on the final day for payment under clause 14.31; but
 - (b) with the amount already paid by the **clearing manager** to a **participant** under this subpart deducted from the amount calculated as payable by the **clearing manager** to the **participant**.
- (2) If funds received or recovered by the **clearing manager** are identifiable as relating to a specific **billing period**, the **clearing manager** must apply those funds in satisfaction or part satisfaction of amounts payable by the **clearing manager** in respect of that **billing period**.
- (3) If it is not clear to which **billing period** the funds relate, the funds must be applied in satisfaction or part satisfaction of amounts payable by the **clearing manager** in respect

of the earliest **billing period** in respect of which amounts are outstanding to the extent that full payment has not been received by the relevant **participants** in respect of that **billing period**.

14.64 Interest payable to participants

- (1) If a **participant** does not receive the full amount payable under this Part, the **clearing manager** is liable to pay interest on the unpaid amount.
- (2) The interest must be calculated daily from the date payment would otherwise have been due, at the **default interest rate**, until the date that payment is actually made by the **clearing manager** to the **participant** and compounded at the end of each calendar month.
- (3) If a **participant** has not paid any amount payable under this Part after the due date for payment, the **participant** must pay interest on the unpaid amount.
- (4) The interest must be calculated daily from the date on which the payment was due, at the **default interest rate**, until the date that full payment is received in **cleared funds** and compounded at the end of each calendar month.

14.65 Participant to remain in default

Despite anything else in this Code, the application of money under this Part that does not satisfy the full amount payable by a **participant** does not—

- (a) satisfy the obligation of the **participant** to pay the full amount payable together with the interest due on that amount to the **clearing manager** or to a **participant** acting in accordance with clause 14.51; or
- (b) prejudice any remedy available to the **clearing manager** in an **event of default** or to a **participant** under clause 14.51.

Subpart 9—Administrative obligations of clearing manager

Clearing manager operating account

14.66 Clearing manager to establish operating account

- (1) The **clearing manager** must establish, in its name, at least one **operating account** with a **bank**.
- (2) Each **operating account** must—
 - (a) be held by the **clearing manager** as a trust account for the benefit of the persons who are entitled to receive payment from the **clearing manager** under this Part; and
 - (b) be clearly identified as such; and
 - (c) subject to this Code, be entirely separate from the **cash deposit accounts** and any other account of the **clearing manager**.
- (3) The **clearing manager** must obtain an acknowledgement from the **bank** with which each **operating account** is held that—
 - (a) the funds in that account are held on trust for the purposes set out in clause 14.33; and

(b) the **bank** has no right of set-off or combination in relation to the funds.
Clause 14.66(1), (2) and (3): amended, on 1 March 2024, by clause 95 of the Electricity Industry Participation Code Amendment (Code Review Programme) 2024.

14.67 Payment by clearing manager

- (1) Each payment required to be made by the **clearing manager** to the person entitled to the payment must be made by direct payment to the **bank** account that the person entitled to the payment may advise the **clearing manager** in writing from time to time.
- (2) Any payment by the **clearing manager** under this Part must be made from the **operating account**.
- (3) Except as expressly permitted by this Code or as required by law, all payments by the **clearing manager** under this Part must be free and clear of any withholding or deduction and without any set-off or counter claim.

Reporting obligations of the clearing manager

14.68 [Revoked]

Clause 14.68(1) and (2): amended, on 5 October 2017, by clause 502 of the Electricity Industry Participation Code Amendment (Code Review Programme) 2017.
Clause 14.68(3)(a), (b), (c) and (d): revoked, on 1 November 2018, by clause 104(a) of the Electricity Industry Participation Code Amendment (Code Review Programme) 2018.
Clause 14.68(3)(e): amended, on 1 November 2018, by clause 104(b) of the Electricity Industry Participation Code Amendment (Code Review Programme) 2018.
Clause 14.68(3)(f): inserted, on 1 November 2018, by clause 104(c) of the Electricity Industry Participation Code Amendment (Code Review Programme) 2018.
Clause 14.68: revoked, on 1 March 2024, by clause 96 of the Electricity Industry Participation Code Amendment (Code Review Programme) 2024.

14.69 [Revoked]

Clause 14.69 Heading: amended, on 5 October 2017, by clause 503(1) of the Electricity Industry Participation Code Amendment (Code Review Programme) 2017.
Clause 14.69(1): amended, on 5 October 2017, by clause 503(2) of the Electricity Industry Participation Code Amendment (Code Review Programme) 2017.
Clause 14.69(2): revoked, on 5 October 2017, by clause 503(3) of the Electricity Industry Participation Code Amendment (Code Review Programme) 2017.
Clause 14.69: revoked, on 1 November 2018, by clause 105 of the Electricity Industry Participation Code Amendment (Code Review Programme) 2018.

14.70 [Revoked]

Clause 14.70: revoked, on 1 November 2018, by clause 106 of the Electricity Industry Participation Code Amendment (Code Review Programme) 2018.

14.71 Clearing manager to make block dispatch settlement differences available

- (1) By 0900 hours on the 2nd **business day** after the **clearing manager** has advised **participants** of amounts owing under clause 14.18, the **clearing manager** must **publish** the following information:
 - (a) the maximum block dispatch settlement difference for each **block dispatch group** for the previous **billing period** as determined by the following formula:

$$\text{Settlement Difference} = \text{Max} \left\{ \sum_{\text{gip}=1}^{\text{gip}} P_{\text{gip}} \left\{ \text{Gen}_{\text{gip}} - \text{Set}_{\text{gip}} \left\{ \frac{\sum \text{Gen}_{\text{gip}}}{\sum \text{Set}_{\text{gip}}} \right\} \right\} \right\}$$

- (b) the total block dispatch settlement differences for each **block dispatch group** for the previous **billing period** as determined by the following formula:

$$\text{Settlement Difference} = \sum_{i=1}^i \left\{ \sum_{\text{gip}=1}^{\text{gip}} P_{\text{gip},i} \left\{ \text{Gen}_{\text{gip},i} - \text{Set}_{\text{gip},i} \left\{ \frac{\sum \text{Gen}_{\text{gip},i}}{\sum \text{Set}_{\text{gip},i}} \right\} \right\} \right\}$$

where

P_{gip} is the **final price** at the relevant **grid injection point** for the **generating plant** or **generating unit** that forms part of the **block dispatch group** for the relevant **trading period** of the **billing period**

Gen_{gip} is the final quantity of **electricity** sold by that **generator** to the **clearing manager** at the relevant **grid injection point** for the **generating plant** or **generating unit** that forms part of the **block dispatch group**, obtained from the **reconciliation information** for the relevant **trading period** of the **billing period**

Set_{gip} is the generation quantity at the **relevant grid injection point** for the **generating plant** or **generating unit** that forms part of the **block dispatch group** for the relevant **trading period** of the **billing period**

$P_{\text{gip},i}$ is the **final price** at the relevant **grid injection point** for the **generating plant** or **generating unit** that forms part of the **block dispatch group** for the relevant **trading period** of the **billing period**

$\text{Gen}_{\text{gip},i}$ is the final quantity of **electricity** sold by that **generator** to the **clearing manager** at the relevant **grid injection point** for the **generating plant** and **generating units** that form part of the **block dispatch group**, obtained from the **reconciliation information** for the relevant **trading period** of the **billing period**

$\text{Set}_{\text{gip},i}$ is the generation quantity at the relevant **grid injection point** for the **generating plant** and **generating units** that form part of the **block dispatch group** for the relevant **trading period** of the **billing period**.

- (2) For the purposes of this clause “generation quantity” means the time-weighted average quantity of **electricity** for that **generating plant** or **generating unit** for the relevant **trading period**, taking into account—

- (a) the quantity in **MW** provided to the **clearing manager** by the **system operator** in accordance with clause 13.76; and
- (b) the ramp rate applying to the relevant **trading period** that is specified in the **offer** submitted by that **generator**.

Clause 14.71 Heading: amended, on 5 October 2017, by clause 504(1) of the Electricity Industry Participation Code Amendment (Code Review Programme) 2017.

Clause 14.71(1): amended, on 5 October 2017, by clause 504(2) of the Electricity Industry Participation Code Amendment (Code Review Programme) 2017.

Clause 14.71(2)(a): amended, on 1 November 2022, by clause 186 of the Electricity Industry Participation Code Amendment (Real Time Pricing) 2022

Clause 14.71(1): amended, on 1 March 2024, by clause 97 of the Electricity Industry Participation Code Amendment (Code Review Programme) 2024.

14.72 Clearing manager to make block dispatch settlement differences available later if clearing manager's external system unavailable

- (1) If the **clearing manager's** external system is unavailable to make the information set out in clause 14.71 available, the **clearing manager** is not obliged to follow any backup procedures in respect of making the information available.
- (2) The **clearing manager** must **publish** the information as soon as reasonably possible after its external system becomes available.

Clause 14.72 Heading: replaced, on 5 October 2017, by clause 505(1) of the Electricity Industry Participation Code Amendment (Code Review Programme) 2017.

Clause 14.72(1): amended, on 5 October 2017, by clause 505(2) of the Electricity Industry Participation Code Amendment (Code Review Programme) 2017.

Clause 14.72(2): replaced, on 5 October 2017, by clause 505(3) of the Electricity Industry Participation Code Amendment (Code Review Programme) 2017.

Clause 14.72 Heading: amended, on 1 March 2024, by clause 98(1) of the Electricity Industry Participation Code Amendment (Code Review Programme) 2024.

Clause 14.72(1) and (2): amended, on 1 March 2024, by clause 98(2) and (3) of the Electricity Industry Participation Code Amendment (Code Review Programme) 2024.

14.73 Clause 14.71 applies to block dispatch groups only

The calculation of the block dispatch settlement differences under clause 14.71 must be completed on a **block dispatch group** basis, even if a **block dispatch group** has been divided into **sub-block dispatch groups** during one or more **trading periods** of the relevant **billing period**.

14.74 No washup calculation under clause 14.71 if revised reconciliation information is received

Following the calculation and **publication** of the information relating to block dispatch settlement differences in a **billing period** under clause 14.71, the **clearing manager** is not required to recalculate any block dispatch settlement differences as a result of subsequently receiving revised **reconciliation information**.

Notices

14.75 Notices

- (1) Except as expressly provided in this Code, a notice or demand given or required to be given under this Part may be given by being delivered or transmitted to the intended recipient at its address or electronic address as last advised in writing to the sender and may be posted to such address by prepaid post.

- (2) Subject to subclause (3),—
- (a) a notice or demand delivered by hand is deemed to be delivered on the date of such delivery; and
 - (b) a notice or demand delivered by post is deemed to be delivered on the 2nd **business day** following the date of posting; and
 - (c) a notice or demand made available on the **clearing manager's** external system is deemed to be delivered on the date it was made available.
- (3) Any notice or demand delivered, or deemed to be delivered, on a day that is not a **business day**, or after 1600 hours on a **business day**, is deemed to have been delivered on the next **business day**.

Clause 14.75(2)(c): amended, on 5 October 2017, by clause 506 of the Electricity Industry Participation Code Amendment (Code Review Programme) 2017.

Clause 14.75(2)(c): amended, on 1 March 2024, by clause 99 of the Electricity Industry Participation Code Amendment (Code Review Programme) 2024.

Schedule 14.1

cl 14.17

Formula for scaling amount owing in respect of FTRs

1 Purpose of this Schedule

The purpose of this Schedule is to set out the formula for scaling the amount owing in respect of **FTRs** if clause 14.17(6) applies.

2 Formula

- (1) The formula for scaling the **FTR hedge value** under clause 14.17(6) is as follows:

$$HV_{\text{Scaled}} = HV \times (C/D)$$

where

HV_{Scaled} is the scaled **FTR hedge value**

HV is the original **FTR hedge value** that would be owing if this subclause did not apply

C is the amount calculated in accordance with the formula in subclause (2)

D is the amount calculated in accordance with the formula in subclause (3)

- (2) The value for C in the formula in subclause (1) is as follows:

$$C = LCE_{\text{FTR}} + AC_{\text{P}} + A_{\text{P}} - AC_{\text{CM}} - A_{\text{CM}}$$

where

LCE_{FTR} is the amount of the **loss and constraint excess** to be applied to the settlement of **FTRs** under clause 14.16(4) or (5)

AC_{P} is the sum of any **FTR acquisition costs** owing to the **clearing manager**

A_{P} is the sum of any amounts owing to the **clearing manager** under clause 13.249(4)

AC_{CM} is the sum of any **FTR acquisition costs** owing by the **clearing manager**

A_{CM} is the sum of any amounts owing by the **clearing manager** under clause 13.249(7)

- (3) The value for D in the formula in subclause (1) is as follows:

$$D = HV_{\text{CM}} - HV_{\text{P}}$$

where

HV_{CM} is the sum of any **FTR hedge values** owing by the **clearing manager**

HV_{P} is the sum of any **FTR hedge values** owing to the **clearing manager**

Schedule 14.2

cl 14.21, 14A.5, Schedule 14A.1

Consultation and approval requirements for methodologies

1 Purpose of this Schedule

This Schedule sets out the consultation and approval requirements that apply to the following methodologies formulated and **published** by the **clearing manager**:

- (a) the methodology for determining the settlement retention amount under clause 14.21;
- (b) the methodology for determining the forward estimate of the minimum amount for which security will be required to be provided by a **participant** under clause 14A.5;
- (c) the methodology for determining the general prudential requirement under clause 8 of Schedule 14A.1;
- (d) the methodology for determining the minimum security required in respect of **FTRs** under clause 12 of Schedule 14A.1.

2 Approval of methodology

- (1) The **clearing manager** must submit to the **Authority** for approval a draft methodology.
- (2) In preparing the draft methodology, the **clearing manager** must—
 - (a) consult with persons that the **clearing manager** thinks are representative of the interests of persons likely to be substantially affected by the methodology; and
 - (b) consider submissions made on the methodology.
- (3) The **clearing manager** must provide a copy of each submission received under subclause (2) to the **Authority**.
- (4) The **Authority** must, as soon as practicable after receiving the draft methodology, by notice in writing to the **clearing manager**—
 - (a) approve the methodology; or
 - (b) decline to approve the methodology.
- (5) If the **Authority** declines to approve the draft methodology, the **Authority** must **publish** the changes that the **Authority** wishes the **clearing manager** to make to the draft methodology.

3 Consultation on proposed changes to methodology

- (1) When the **Authority publishes** the changes that the **Authority** wishes the **clearing manager** to make to the draft methodology under clause 2(5), the **Authority** must **publish** the date by which submissions on the changes must be received by the **Authority**.
- (2) Each submission on the changes to the draft methodology must be made in writing to the **Authority** and be received on or before the date specified by the **Authority** under subclause (1).
- (3) The **Authority** must—
 - (a) provide a copy of each submission received to the **clearing manager**; and
 - (b) **publish** the submissions.

- (4) The **clearing manager** may make its own submission on the changes to the draft methodology and the submissions received in relation to the changes.
- (5) The **Authority** must **publish** the **clearing manager's** submission when it is received.
- (6) The **Authority** must consider the submissions made to it on the changes to the draft methodology.
- (7) Following the consultation required by subclauses (1) to (6), the **Authority** may approve the methodology subject to the changes that the **Authority** considers appropriate being made by the **clearing manager**.

Clause 3(1): amended, on 5 October 2017, by clause 507 of the Electricity Industry Participation Code Amendment (Code Review Programme) 2017.

4 Variations to methodology

- (1) A **participant** or the **Authority** may submit a proposal for a variation to the methodology.
- (2) The **clearing manager** must provide a copy of each proposed variation received from a **participant** under subclause (1) to the **Authority**.
- (3) The **clearing manager** must consider a proposed variation to the methodology submitted under subclause (1).
- (4) The **clearing manager** may submit a request for a variation to the methodology to the **Authority**.
- (5) The consultation and approval requirements under clauses 2 and 3 apply to a request for a variation submitted under subclause (4) as if references to the draft methodology were a reference to the requested variation.
- (6) If the **clearing manager** does not submit a request for a variation submitted under subclause (1) to the **Authority** under subclause (4), the **Authority** may consider the proposal and require the **clearing manager** to submit a request for a variation based on the proposal to the **Authority**, and subclause (5) applies accordingly.
- (7) The **Authority** may approve a variation requested under subclause (4) or subclause (6) without complying with the provisions referred to in subclause (5) if—
 - (a) the **Authority** considers that it is necessary or desirable in the public interest that the requested variation be made urgently; and
 - (b) the **Authority publishes** a notice of the variation and a statement of the reasons why the urgent variation is needed.
- (8) Every variation made under subclause (7) expires on the date that is 9 months after the date on which the variation is made.

Schedule 14.3

cl 14.16(2)

Calculation of amount of loss and constraint excess to be applied to the settlement of FTRs

1 Purpose

The purpose of this Schedule is to set out the formulae and process for the calculation under clause 14.16(2) of the amount of the **loss and constraint excess** to be applied to the settlement of **FTRs**.

2 Interpretation

(1) In this Schedule, unless the context otherwise requires,—

AC line means any **AC branch**

balanced, in relation to an **FTR injection pattern**, means that the total positive and negative **hub injections** sum to 0. A **balanced FTR injection pattern** is consistent with a **grid** in which **losses** are not modelled

binding, in relation to a **constraint**, means that the **constraint** has a non-zero **shadow price**

branch constraint means a **constraint** in which all the **LHS** variables are branch flows

canonical form means a linear programming problem that is expressed in the following form:

maximise $c^T x$

subject to $Ax \leq b$

where

x is the vector of variables to be determined

c and b are vectors of constants

A is a matrix of coefficients

$c^T x$ is the objective function to be maximised

$Ax \leq b$ is the set of **constraints**, each row of Ax being the **LHS** of a **constraint** and each element of b being the corresponding **RHS**

Minimum **constraints** are assumed to have been multiplied through by -1 to form an equivalent maximum **constraint**

Equality **constraints** are assumed to have initially been represented by a pair of minimum and maximum **constraints** with the same **LHS** and **RHS**, and then the resulting minimum **constraint** is assumed to have been multiplied through by -1 to form an equivalent maximum **constraint**

closed, in relation to a **branch**, means that the **branch** is **electrically connected** at both ends

dispatch interval means the period, within a **trading period**, during which a **dispatch instruction** issued by the **system operator** remains in effect

dispatch schedule also includes a **price-responsive schedule**, when it is used to calculate final prices in accordance with clause 13.134A.

feasible region, in relation to an n-dimensional linear programming problem, means the n-dimensional solution space filled by the set of all possible feasible solutions

final pricing schedule [*Revoked*]/**FTR injection pattern** means the combination of positive or negative net **hub injections** implied by a combination of **FTRs**

hub injection means the actual or notional flow of **electricity** into the **grid**, if positive, or out of the **grid**, if negative, at any **hub**

HVDC link has the same meaning as in the **model formulation**

LHS means the left hand side of a **constraint** expressed in **canonical form**

mixed constraint has the same meaning as in the **model formulation**

open, in relation to a **branch**, means that the **branch** is **electrically disconnected** at 1 or both ends

operational system split means an instance where a **grid owner** chooses to operate with a switch or **branch open** for reasons such as—

- (a) breaking loops that would otherwise constrain flows; or
- (b) reducing the size of the maximum fault duty that switchgear needs to withstand

RHS means the right hand side of a **constraint** when expressed in **canonical form**

scheduled, in relation to a variable, means the value of the variable in the **dispatch schedule**

shadow price, in relation to an **AC line** capacity, **branch constraint** or **mixed constraint**, means the absolute value of the shadow price in \$/MWh for the **AC line** or **constraint** reported in the **dispatch schedule**

simultaneously feasible, in relation to an **FTR injection pattern**, means that the implied flows can be carried by the transmission system, subject to the **constraints** as defined by clause 5(2).

Clause 2(1) **dispatch interval** and **dispatch schedule**: inserted, on 1 November 2022, by clause 187(1) of the Electricity Industry Participation Code Amendment (Real Time Pricing) 2022.

Clause 2(1) **closed**: amended, on 5 October 2017, by clause 508(1) of the Electricity Industry Participation Code Amendment (Code Review Programme) 2017.

Clause 2(1) **final pricing schedule**: revoked, on 1 November 2022, by clause 187(2) of the Electricity Industry Participation Code Amendment (Real Time Pricing) 2022.

Clause 2(1) **open**: amended, on 5 October 2017, by clause 508(2) of the Electricity Industry Participation Code Amendment (Code Review Programme) 2017.

Clause 2(1) **scheduled**: amended, on 1 November 2022, by clause 187(3) of the Electricity Industry Participation Code Amendment (Real Time Pricing) 2022.

Clause 2(1) **shadow price**: amended, on 1 November 2022, by clause 187(4) of the Electricity Industry Participation Code Amendment (Real Time Pricing) 2022.

- (2) For the purposes of this Schedule, **constraints** that are not expressed in **canonical form** in the **model formulation** must be translated into the equivalent **canonical form**.

3 Amount of loss and constraint excess to be applied to settlement of FTRs

The amount of the **loss and constraint excess** that must be applied to the settlement of **FTRs** under clause 14.16(4) is the amount calculated under clause 9(6)(b).

4 Grid owner must determine normal grid configuration

- (1) Each **grid owner** must determine a normal **grid** configuration for the **grid owner's grid**.
- (2) The normal **grid** configuration determined under subclause (1) must be a **grid** configuration with all existing **branches** and switches **closed** except where the **grid owner** has implemented **operational system splits** and the **grid owner** considers that the normal state of those **operational system splits** is for the relevant **branch** or switch to be **open**.
- (3) Each **grid owner** must provide to the **FTR manager** the information describing the normal **grid** configuration for the **grid owner's grid** determined under subclause (1).
- (4) Each **grid owner** must determine a new normal **grid** configuration for the **grid owner's grid** if the **grid owner** considers it necessary because, for example, any of the following occur:
- (a) some **grid** equipment is **commissioned** or **decommissioned**;
 - (b) there is a change in the capacity or impedance of some **grid** equipment;
 - (c) the **grid owner** considers that the normal state of any **operational system split** has changed.
- (5) Each **grid owner** must provide new information to the **FTR manager** if the **grid owner** determines a new normal **grid** configuration for the **grid owner's grid** under subclause (4), unless otherwise agreed with the **FTR manager**.

Clause 4(3) and (5): amended, on 24 March 2015, by clause 18 of the Electricity Industry Participation Code Amendment (Settlement and Prudential Security) 2014.

Clause 4(4)(a): amended, on 5 October 2017, by clause 509 of the Electricity Industry Participation Code Amendment (Code Review Programme) 2017.

5 FTR manager must determine FTR injection patterns

- (1) The **FTR manager** must determine a set of **balanced** extreme **FTR injection patterns**.
- (2) Each **balanced** extreme **FTR injection pattern** determined under subclause (1) must be **simultaneously feasible** assuming—
- (a) the normal **grid** configuration determined under clause 4; and
 - (b) the absence of all other **grid** flows; and
 - (c) all **AC line** and **HVDC link** capacity limits applied; and
 - (d) all risk and reserve **constraints** disabled; and
 - (e) all **branch** variable **losses** set to 0; and
 - (f) all **branch** fixed **losses** set to 0.
- (3) The set of **balanced** extreme **FTR injection patterns** determined under subclause (1) must, in the reasonable opinion of the **FTR manager**, be the set of **FTR injection**

patterns that best represents the extreme limits of the **feasible region** of **FTR injection patterns** as defined by the assumptions listed under subclause (2).

- (4) The **FTR manager** must determine a new set of **balanced** extreme **FTR injection patterns** if—
- (a) a **grid owner** provides the **FTR manager** with new information under clause 4(5) that results in a change to the **feasible region** of **FTR injection patterns**; or
 - (b) there is a change to the **hubs** or set of **hubs** specified in the **FTR allocation plan**.

Clause 5(4)(a): amended, on 24 March 2015, by clause 19 of the Electricity Industry Participation Code Amendment (Settlement and Prudential Security) 2014.

6 **FTR manager must determine matrix of lossless shift factors**

- (1) For each **dispatch interval** of the relevant **billing period**, following the **publication** of **final prices**, the **FTR manager** must determine a matrix of lossless shift factors referenced to a set of reference **nodes**, from the inputs to the **dispatch schedule** described in clause 13.69B or clause 13.58A (as applicable), in accordance with the following:
- (a) one reference **node** must be chosen within each electrical island;
 - (b) **nodes** are in the same electrical island if a transmission path exists between them.
- (2) The matrix of lossless shift factors determined under subclause (1) must be calculated in accordance with the following matrix formula:

$$[\text{ShiftFactor}] = [\text{AdmittancePrimitive}] \times [\text{Inc}] \times [\text{Impedance}]$$

where

$[\text{ShiftFactor}]$	is the m by n matrix of lossless shift factors, which defines the increment in flow in the conventional forward flow direction on any branch in the transmission network resulting from an increment in net injection at any node together with an equal decrement in net injection at the reference node in the electrical island in which the node resides, while neglecting the effect of losses
$[\text{AdmittancePrimitive}]$	is the m by m diagonal matrix formed from the set of m branch susceptances
$[\text{Inc}]$	is the m by n lossless

- branch-node** incidence matrix, which denotes the conventional from and to **nodes** for a **branch** by matrix entries of 1 and -1 respectively
- [Impedance] is the n by n matrix formed from the inverse of [AdmittanceNodal] with the columns and rows associated with the reference **nodes** reinserted and filled with zeroes
- [AdmittanceNodal] is the $n-r$ by $n-r$ matrix obtained from [AdmittanceNodalComplete] by deleting the column and row associated with each of the reference **nodes**
- [AdmittanceNodalComplete] is the n by n matrix =
$$\begin{bmatrix} [\text{Inc}^T] & \times \\ [\text{AdmittancePrimitive}] & \times \\ [\text{Inc}] \end{bmatrix}$$
- [Inc^T] is the n by m matrix transpose of [Inc]
- (3) For the purposes of subclauses (1) and (2) —
- the set of inter-**island HVDC links** must be replaced by a single **AC line** with a nominal susceptance value between the Benmore and Haywards HVDC terminal **nodes**, whether or not any **HVDC link** is actually in service during the relevant **dispatch interval**; and
 - the nominal susceptance value determined under paragraph (a) may be any suitable value that will avoid numerical difficulties; and
 - any switches between the Benmore HVDC terminal **node** and other Benmore **nodes** operating at the same nominal voltage that are normally **closed** must be treated as **closed**; and
 - any switches between the Haywards HVDC terminal **node** and other Haywards **nodes** operating at the same nominal voltage that are normally **closed** must be treated as **closed**; and
 - in any **dispatch interval** in which any of the **hubs** reside in different electrical islands (as defined in subclause (1)(b)), the shift factor matrix for the previous **trading period** in which all the **hubs** resided in the same electrical island must be used.

Clause 6(1), (3)(a) and (3)(e): amended, on 1 November 2022, by clause 188(1) and (2) of the Electricity Industry Participation Code Amendment (Real Time Pricing) 2022.

7 FTR manager must determine branch participation loading and constraint participation loading

- (1) For each **dispatch interval** of the relevant **billing period**, the **FTR manager** must determine a **branch** participation loading for each **AC line** k .
- (2) Each **branch** participation loading determined under subclause (1) must be calculated—
- (a) in accordance with the following formula if the **scheduled** flow on the **AC line** is in the conventional forward flow direction:

$$\max\left(\sum_{h \in Hubs} SF_{k,h} \times Inj_{h,p} : p \in 1, \dots, P\right); \text{ and}$$

- (b) in accordance with the following formula if the **scheduled** flow on the **AC line** is in the conventional reverse flow direction:

$$-\min\left(\sum_{h \in Hubs} SF_{k,h} \times Inj_{h,p} : p \in 1, \dots, P\right)$$

where

$SF_{k,h}$ is the shift factor relating flows on **AC line** k to **injections** at **hub** h , determined under clause 6(1)

$Inj_{h,p}$ is the positive or negative **hub injection** at **hub** h in **FTR injection pattern** p in the set of P **balanced** extreme **FTR injection patterns** determined under clause 5(1)

- (3) For each **dispatch interval** of the relevant **billing period**, for each **binding branch constraint** v involving **AC line** flows, the **FTR manager** must determine a **constraint** participation loading in accordance with the following formula:

$$\max\left(\sum_{k \in ACLineGroup_v} \sum_{h \in Hubs} weight_{k,v} \times SF_{k,h} \times Inj_{h,p} : p \in 1, \dots, P\right) \text{ where}$$

$SF_{k,h}$ and $Inj_{h,p}$ are as defined in subclause (2)

$ACLineGroup_v$ is the set of **AC lines** involved in **branch constraint** v (any **HVDC link** flow terms in the **constraint** must be excluded from this calculation)

$weight_{k,v}$ is the weight associated with **AC Line** k in **branch constraint** v expressed in **canonical form**

- (4) For each **dispatch interval** of the relevant **billing period**, for each **binding mixed constraint** v (if any) involving **AC line** flow terms or **AC line** variable loss terms, the **FTR manager** must determine a **constraint** participation loading in accordance with the following formula:

$$\max \left(\sum_{k \in ACLineGroup_v} (flowweight_{k,v} \times flow_{k,p} + lossweight_{k,v} \times loss_{k,p}) : p \in 1, \dots, P \right) \text{ where}$$

$ACLineGroup_v$ is the set of **AC lines** whose flows or variable **losses** are involved in **mixed constraint** v (all other terms in the **mixed constraint** must be excluded from this calculation)

$flowweight_{k,v}$ is the weight associated with the flow on **AC Line** k in **mixed constraint** v expressed in **canonical form**

$lossweight_{k,v}$ is the weight associated with the variable **losses** on **AC Line** k in **mixed constraint** v expressed in **canonical form**

$flow_{k,p}$ is the flow on **AC Line** k due to **FTR injection pattern** p , which equals $\sum_{h \in Hubs} SF_{k,h} \times Inj_{h,p}$

$loss_{k,p}$ is the variable **losses** on **AC Line** k due to $flow_{k,p}$

$SF_{k,h}$ and $Inj_{h,p}$ are as defined in subclause (2)

- (5) For the purposes of this clause, if **hub** h is a group of **nodes**, the positive or negative **hub injection** at **hub** h must be split into its individual nodal components in a manner consistent with the **hub** definition in the **FTR allocation plan**, and each nodal component must be treated as a separate **hub injection**.

Clause 7(1), (3) and (4): amended, on 1 November 2022, by clause 189 of the Electricity Industry Participation Code Amendment (Real Time Pricing) 2022.

8 FTR manager must assign portions of capacities

- (1) For each **dispatch interval** of the relevant **billing period**, the **FTR manager** must assign a portion of the capacity of each **AC line**, **AC line** loss curve block, **binding branch constraint RHS** and **binding mixed constraint RHS** (if any) for the purpose of determining amounts to be applied to the settlement of **FTRs** under clause 9(3) to (5).
- (2) The portion of the capacity of each **AC line** to be assigned under subclause (1) must be the minimum of—

- (a) the line capacity applicable in the **trading period** in the **dispatch schedule** relating to the **dispatch interval**; and
- (b) the relevant **branch** participation loading determined under clause 7(1).
- (3) The portion of the capacity of each **AC line** loss curve block to be assigned under subclause (1) must be the portion of the loss curve block that would be utilised by a flow at the level of the capacity of the associated **AC line** assigned, as determined under subclause (2), assuming that loss curve blocks are utilised in order from lowest to highest **loss factor**, in the direction of flow.
- (4) Subject to subclause (5), the portion of the capacity of each **binding branch constraint RHS** or **binding mixed constraint RHS** (if any) to be assigned under subclause (1) must be the minimum of—
- (a) the **constraint RHS** applicable in the **trading period** in the **dispatch schedule** relating to the **dispatch interval**, minus the contribution of any **LHS** terms not involving **AC line** flows or **AC line** variable losses, calculated assuming the values of the relevant variables applicable in the **trading period** in the **dispatch schedule** relating to the **dispatch interval**; and
- (b) the relevant **constraint** participation loading determined under clause 7(3) or clause 7(4).
- (5) If the capacity determined under subclause (4) for any **constraint** is negative, the capacity to be assigned for that **constraint** must be 0.

Clause 8(1): amended, on 1 November 2022, by clause 190(1) of the Electricity Industry Participation Code Amendment (Real Time Pricing) 2022.

Clause 8(2), (4)(a): amended, on 1 November 2022, by clause 190(2) of the Electricity Industry Participation Code Amendment (Real Time Pricing) 2022.

9 FTR manager must calculate amounts to be applied to settlement of FTRs

- (1) The amounts calculated under this clause must be calculated using the flow quantities, nodal prices and **shadow prices** from the **dispatch schedule** relating to each **dispatch interval**.
- (2) The HVDC **loss and constraint excess** to be applied to the settlement of **FTRs** for each **dispatch interval** of the relevant **billing period** must be calculated in accordance with the following formula:

$$\max \left(\begin{array}{l} 0, \sum_{n(NI)} price_n \times \left(\sum_{l \in R_{HVDC}(n)} (HVDCLinkFlow_l - HVDCLinkLosses_l) - \sum_{l \in S_{HVDC}(n)} HVDCLinkFlow_l \right) \\ + \sum_{n(SI)} price_n \times \left(\sum_{l \in R_{HVDC}(n)} (HVDCLinkFlow_l - HVDCLinkLosses_l) - \sum_{l \in S_{HVDC}(n)} HVDCLinkFlow_l \right) \end{array} \right) \times \frac{IntervalDuration}{3600}$$

where

$price_n$ is the energy price at AC node n

$n(NI)$ is the set of North Island AC **nodes** to which any **HVDC links** are connected

$n(SI)$ is the set of South Island AC **nodes** to which any **HVDC links** are connected

$HVDCLinkFlow_l$ is the **MW** flow at the sending end **scheduled** for **HVDC link** l

$HVDCLinkLosses_l$ is the variable **MW losses** for **HVDC link** l

$S_{HVDC}(n)$ is the set of **HVDC links** for which n is the sending AC **node**

$R_{HVDC}(n)$ is the set of **HVDC links** for which n is the receiving AC **node**

$IntervalDuration$ is the duration of the **dispatch interval** in seconds

- (3) The amount of the **loss and constraint excess** generated by each **AC line** that is to be applied to the settlement of **FTRs** must be calculated in accordance with the following formula:

$$AssignedCapacity_k \times ShadowPrice_k \times \frac{IntervalDuration}{3600}$$

where

$AssignedCapacity_k$ is the portion of the capacity of **AC line** k assigned under clause 8(1)

$ShadowPrice_k$ is the **shadow price** of the line capacity on **AC line** k

$IntervalDuration$ is the duration of the

dispatch interval in
seconds

- (4) The amount of the **loss and constraint excess** generated by each **binding branch constraint** and **binding mixed constraint** (if any) involving **AC line** flow terms or **AC line** variable loss terms to be applied to the settlement of **FTRs** must be calculated in accordance with the following formula:

$$AssignedCapacity_v \times ShadowPrice_v \times \frac{IntervalDuration}{3600}$$

where

AssignedCapacity_v is the portion of the capacity of the **RHS** of **branch constraint** or **mixed constraint** *v* assigned under clause 8(1)

ShadowPrice_v is the **shadow price** of **branch constraint** or **mixed constraint** *v*

IntervalDuration is the duration of the **dispatch interval** in seconds

- (5) The amount of the **loss and constraint excess** generated by each **AC line** loss curve block that is to be applied to the settlement of **FTRs** must be calculated in accordance with the following formula:

$$\min(ACLineFlowBlock_{k,j}, AssignedCapacity_{k,j}) \times ReceivingEndPrice_k \\ \times (ACLineLossFactor_{k,m\ arg} - ACLineLossFactor_{k,j}) \times \frac{IntervalDuration}{3600}$$

where

$$ACLineLossFactor_{k,m\ arg} = \min(ACLineLossFactor_{k,j}) \text{ for which } \\ ACLineFlowBlock_{k,j} < ACLineLossMW_{k,j}$$

ACLineFlowBlock_{k,j} is the **MW** flow on the *jth* block of the loss curve of **AC line** *k* in the direction of **scheduled** positive flow, assuming that loss curve blocks are utilised in order from lowest to highest **loss**

factor, in each direction

AssignedCapacity_{k,j} is the portion of the capacity of the j^{th} block of the loss curve of **AC line k** assigned under clause 8(1)

ReceivingEndPrice_k is the nodal energy price at the receiving end of the **scheduled flow on AC line k**

ACLLineLossFactor_{k,j} is the **loss factor** of the j^{th} block of the loss curve of **AC line k**

ACLLineLossMW_{k,j} is the **MW capacity** of the j^{th} block of the loss curve of **AC line k**

IntervalDuration is the duration of the **dispatch interval** in seconds

- (6) The **FTR manager** must calculate the amount of the **loss and constraint excess** that must be applied to the settlement of **FTRs** for each **billing period** by—
- (a) determining the sum of the amounts calculated in accordance with subclauses (2) to (5) for each **dispatch interval** of the **billing period**; and
 - (b) determining the sum of the amounts calculated in accordance with paragraph (a) for all **dispatch intervals** of the **billing period**.

Clause 9: replaced, on 1 November 2022, by clause 191 of the Electricity Industry Participation Code Amendment (Real Time Pricing) 2022.

Schedule 14.4
Forms of hedge settlement agreement

cl 14.8

Form 1

Date: [Enter date]

Party A	
Party B	

1 Lodging of hedge settlement agreement

- (1) Party A and Party B (the **parties**) submit this **hedge settlement agreement** to the **clearing manager**, as contemplated by clause 14.8 of the Electricity Industry Participation Code 2010 (the **Code**). Terms that are used in this agreement but not defined bear the meaning given to them in the **Code**.
- (2) By submitting this **hedge settlement agreement** to the **clearing manager** in accordance with clause 14.8 of the **Code**, the **parties** agree to be bound by the terms set out below from the time at which the **clearing manager** counter-signs it.
- (3) If the **clearing manager** counter-signs this document then, from the time it counter-signs, it has obligations relating to it under the **Code**. However, the **parties** acknowledge the **clearing manager** is not bound by this document and that its obligations in relation to it are limited to those set out in the **Code**.

2 Definitions

The following definitions apply in this document:

aggregate fixed amount means, in relation to a **billing period**, the sum of the **fixed amounts** for each **calculation period** in that **billing period**

aggregate floating amount means, in relation to a **billing period**, the sum of the **floating amounts** for each **calculation period** in that **billing period**

business day means any day of the week except Saturdays, Sundays, **national holidays**, the day observed as Wellington Anniversary Day, and any other day from time to time declared by the **Authority** not to be a **business day** by notice to each **registered participant**

calculation period means a **trading period** during the **term**

commencement date means the date specified as such in the schedule

expiry date means the date specified as such in the schedule

fixed amount means, in relation to a **calculation period**, an amount calculated using the following formula:

$$\text{fixed amount} = \text{notional quantity} \times \text{fixed price}$$

fixed price means, in relation to a **calculation period**, the amount specified as such for that **calculation period** in the schedule

fixed price payer means, in relation to a **hedge settlement agreement**, the party specified as such in the schedule

floating amount means, in relation to a **calculation period**, an amount calculated using the following formula:

$$\text{floating amount} = \text{notional quantity} \times \text{floating price}$$

floating price means, in relation to a **calculation period**, the **final price** per MWh for that **calculation period** by reference to the **hedge reference point** [rounded to two decimal places]

floating price payer means, in relation to a **hedge settlement agreement**, the party specified as such in the schedule

hedge reference point means the **grid exit point** specified as such in the schedule

hedge settlement amount means, in relation to a **billing period**, the absolute value of the amount calculated by subtracting the **aggregate floating amount** from the **aggregate fixed amount**

notional quantity means, in relation to a **calculation period**, the number of MWhs specified as such in the schedule for that **calculation period**

settlement date means the date on which payments are due under clause 14.31 of the Code

term means the period from 00.00 hours on the **commencement date** until 23.59 hours on the date on which the **hedge settlement agreement** terminates.

3 Payment of hedge settlement amounts

In relation to a **billing period**:

- (a) if the **aggregate floating amount** exceeds the **aggregate fixed amount**:
 - (i) the **floating price payer** must pay the **clearing manager** an amount equal to the **hedge settlement amount** in relation to that **billing period**; and
 - (ii) the **clearing manager** must pay the **fixed price payer** an amount equal to the **hedge settlement amount** in relation to that **billing period**, on the relevant **settlement date**; and
- (b) if the **aggregate fixed amount** exceeds the **aggregate floating amount**:
 - (i) the **fixed price payer** must pay the **clearing manager** an amount equal to the **hedge settlement amount** in relation to that **billing period**; and
 - (ii) the **clearing manager** must pay the **floating price payer** an amount equal to the **hedge settlement amount** in relation to that **billing period**, on the relevant **settlement date**; and
- (c) the **clearing manager** must calculate the amounts to be payable by and to the **parties** and advise each **party** of those amounts by the 5th **business day** of the month following the **billing period**. If either **party** notifies the **clearing manager**

in writing by the 7th **business day** of the month following the **billing period** of any issues with the amounts the **clearing manager** has advised are to be payable, the **clearing manager** will use reasonable endeavours to correct the issues before issuing invoices on the 9th **business day** of the month following the **billing period** under clause 14.18(2) of the **Code**.

4 Termination

This **hedge settlement agreement** terminates on the earlier of:

- (a) the **expiry date**; and
- (b) the date on which it is cancelled under the **Code**.

5 Other provisions

- (1) The **fixed price** is inclusive of any additional costs arising due to carbon charges.
- (2) Where the terms of this **hedge settlement agreement** include reference to—
 - (a) day, this means both **business days** and non-**business days**;
 - (b) weekday, this means a **business day**;
 - (c) weekend, this means non-**business days**.
- (3) Where daylight savings starts or ends during the **term** of this **hedge settlement agreement**, the **clearing manager** will calculate the **fixed amounts** and **floating amounts** for the days on which daylight savings starts or ends in the same way the **clearing manager** calculates the sale and purchase of **electricity** for these days.

EXECUTION

[Execution Block Party A]

[Execution Block Party B]

The **clearing manager** accepts the lodgement of this **hedge settlement agreement** by counter-signing it.

[Execution Block Clearing Manager]

SCHEDULE TERMS OF HEDGE SETTLEMENT AGREEMENT

Hedge settlement agreement terms	
Commencement Date	[Insert date]
Expiry Date	[Insert date]
Fixed Price Payer	[Party A] [Party B]

Electricity Industry Participation Code 2010
Schedule 14.4

Floating Price Payer	[Party A] [Party B]
Notional Quantity	[insert number] MWh for each calculation period
Fixed Price	[\$[insert amount] / MWh
Hedge Reference Point	[insert grid exit point]

Schedule 14.4, Schedule to Form 1: amended, on 24 March 2015, by clause 20 of the Electricity Industry Participation Code Amendment (Settlement and Prudential Security) 2014.

Schedule 14.4, Form 1, clause 2 **business day**: inserted, on 1 March 2024, by clause 100 of the Electricity Industry Participation Code Amendment (Code Review Programme) 2024.

Schedule 14.4, Form 1, clause 3(b): amended, on 1 March 2024, by clause 101(a) of the Electricity Industry Participation Code Amendment (Code Review Programme) 2024.

Schedule 14.4, Form 1, clause 3(c): inserted, on 1 March 2024, by clause 101(b) of the Electricity Industry Participation Code Amendment (Code Review Programme) 2024.

Schedule 14.4, Form 1, clause 5: replaced, on 1 March 2024, by clause 102 of the Electricity Industry Participation Code Amendment (Code Review Programme) 2024.

Form 2: Cap/Floor Calculation Period Price

[Note (not for inclusion in form): This form can be used to achieve both a capped price and a floor price.]

Date: [Enter date]

Party A	
Party B	

1 Lodging of hedge settlement agreement

- (1) Party A and Party B (the **parties**) submit this **hedge settlement agreement** to the **clearing manager**, as contemplated by clause 14.8 of the Electricity Industry Participation Code 2010 (the **Code**). Terms that are used in this agreement but not defined bear the meaning given to them in the **Code**.
- (2) By submitting this **hedge settlement agreement** to the **clearing manager** in accordance with clause 14.8 of the **Code**, the **parties** agree to be bound by the terms set out below from the time at which the **clearing manager** counter-signs it.
- (3) If the **clearing manager** counter-signs this document then, from the time it counter-signs, it has obligations relating to it under the **Code**. However, the **parties** acknowledge the **clearing manager** is not bound by this document and that its obligations in relation to it are limited to those set out in the **Code**.

2 Definitions

The following definitions apply in this document:

business day means any day of the week except Saturdays, Sundays, **national holidays**, the day observed as Wellington Anniversary Day, and any other day from time to time declared by the **Authority** not to be a **business day** by notice to each **registered participant**

calculation period means a **trading period** during the **term**

calculation period premium means, in relation to a **calculation period**, the amount specified as such in the schedule for that **calculation period**

calculation period settlement amount means, in relation to a **calculation period**, an amount calculated using the following formula:

calculation period settlement amount = **notional quantity** x **strike price differential**

cash settlement amount means, in relation to a **billing period**, the sum of the **calculation period settlement amounts** for each **calculation period** in that **billing period**

commencement date means the date specified as such in the schedule

expiry date means the date specified as such in the schedule

floating price means, in relation to a **calculation period**, the **final price** per MWh for that **calculation period** by reference to the **hedge reference point** [rounded to two decimal places]

hedge reference point means the **grid exit point** specified as such in the schedule

notional quantity means, in relation to a **calculation period**, the number of MWhs specified as such in the schedule for that **calculation period**

option buyer means, in relation to a **hedge settlement agreement**, the party specified as such in the schedule

option premium means, in relation to a **billing period**, the sum of the **calculation period premiums** for each **calculation period** in that **billing period**

option seller means, in relation to a **hedge settlement agreement**, the party specified as such in the schedule

option type means either a put option or a call option as specified in the schedule

settlement date means the date on which payments are due under clause 14.31 of the Code

strike price means, in relation to a **calculation period**, the amount specified as such in the schedule

strike price differential means, in relation to a **calculation period**, an amount equal to:

- (a) if the **option type** is a put option, the greater of the **strike price** minus the **floating price** and zero;
- (b) if the **option type** is a call option, the greater of the **floating price** minus the **strike price** and zero

term means the period from 00.00 hours on the **commencement date** until 23.59 hours on the date on which the **hedge settlement agreement** terminates.

3 Payment of hedge settlement amounts

(1) In relation to a **billing period**:

- (a) the **option buyer** must pay the **clearing manager** an amount equal to the **option premium** for that **billing period**; and
- (b) the **clearing manager** must pay the **option seller** an amount equal to the **option premium** for that **billing period**; and
- (c) the **option seller** must pay the **clearing manager** an amount equal to the **cash settlement amount** for that **billing period**; and
- (d) the **clearing manager** must pay the **option buyer** an amount equal to the **cash settlement amount** for that **billing period**, on the relevant **settlement date**.

(2) In relation to a billing period, the **clearing manager** must calculate the amounts to be payable by and to the **parties** and advise each **party** of those amounts by the 5th

business day of the month following the **billing period**. If either **party** notifies the **clearing manager** in writing by the 7th **business day** of the month following the **billing period** of any issues with the amounts the **clearing manager** has advised are to be payable, the **clearing manager** will use reasonable endeavours to correct the issues before issuing invoices on the 9th **business day** of the month following the **billing period** under clause 14.18(2) of the **Code**.**4 Termination**

This **hedge settlement agreement** terminates on the earlier of:

- (a) the **expiry date**; and
- (b) the date on which it is cancelled under the **Code**.

5 Other provisions

- (1) The **strike price** is inclusive of any additional costs arising due to carbon charges.
- (2) Where the terms of this **hedge settlement agreement** include reference to—
 - (a) day, this means both **business days** and non-**business days**;
 - (b) weekday, this means a **business day**;
 - (c) weekend, this means non-**business days**.
- (3) Where daylight savings starts or ends during the **term** of this **hedge settlement agreement**, the **clearing manager** will calculate the **calculation period premium** and **calculation period settlement amounts** for these days in the same way the **clearing manager** calculates the sale and purchase of **electricity** for these days.

EXECUTION

[Execution Block Party A]

[Execution Block Party B]

The **clearing manager** accepts the lodgement of this **hedge settlement agreement** by counter-signing it.

[Execution Block Clearing Manager]

SCHEDULE TERMS OF HEDGE SETTLEMENT AGREEMENT

Hedge settlement agreement terms	
Commencement Date	[Insert date]
Expiry Date	[Insert date]
Option Buyer	[Party A] [Party B]

Electricity Industry Participation Code 2010
Schedule 14.4

Option Seller	[Party A] [Party B]
Option Type	[Call Option] [Put Option]
Notional Quantity	[insert number] MWh for each calculation period
Strike Price	[\$[insert amount] /MWh
Calculation Period Premium	[\$[insert amount] for each calculation period
Hedge Reference Point	[insert grid exit point]

Schedule 14.4, Schedule to Form 2: amended, on 24 March 2015, by clause 21 of the Electricity Industry Participation Code Amendment (Settlement and Prudential Security) 2014.

Schedule 14.4, Form 2, clause 2 business day: inserted, on 1 March 2024, by clause 103 of the Electricity Industry Participation Code Amendment (Code Review Programme) 2024.

Schedule 14.4, Form 2, clause 3(2): inserted, on 1 March 2024, by clause 104 of the Electricity Industry Participation Code Amendment (Code Review Programme) 2024.

Schedule 14.4, Form 2, clause 5: replaced, on 1 March 2024, by clause 105 of the Electricity Industry Participation Code Amendment (Code Review Programme) 2024.

Form 3: Cap/Floor Average Price

[Note (not for inclusion in form): This form can be used to achieve both a capped average price over a defined period and a floor average price over a period.]

Date: [Enter date]

Party A	
Party B	

1 Lodging of hedge settlement agreement

- (1) Party A and Party B (the **parties**) submit this **hedge settlement agreement** to the **clearing manager**, as contemplated by clause 14.8 of the Electricity Industry Participation Code 2010 (the **Code**). Terms that are used in this agreement but not defined bear the meaning given to them in the **Code**.
- (2) By submitting this **hedge settlement agreement** to the **clearing manager** in accordance with clause 14.8 of the **Code**, the **parties** agree to be bound by the terms set out below from the time at which the **clearing manager** counter-signs it.
- (3) If the **clearing manager** counter-signs this document then, from the time it counter-signs, it has obligations relating to it under the **Code**. However, the **parties** acknowledge the **clearing manager** is not bound by this document and that its obligations in relation to it are limited to those set out in the **Code**.

2 Definitions

The following definitions apply in this document:

average floating price means, in relation to an **option period**, an amount calculated using the following formula:

$$\text{average floating price} = \frac{\text{option period floating amount}}{\text{option period notional quantity}}$$

business day means any day of the week except Saturdays, Sundays, **national holidays**, the day observed as Wellington Anniversary Day, and any other day from time to time declared by the **Authority** not to be a **business day** by notice to each **registered participant**

calculation period means a **trading period** during the **term**

calculation period floating amount means, in relation to a **calculation period**, an amount calculated using the following formula:

$$\text{calculation period floating amount} = \text{notional quantity} \times \text{floating price}$$

calculation period notional quantity *[Revoked]*

calculation period premium means, in relation to a **calculation period**, the amount specified as such in the schedule for that **calculation period**

cash settlement amount means, in relation to a **billing period**, the sum of the **option period settlement amounts** for each **option period** in that **billing period**

commencement date means the date specified as such in the schedule

expiry date means the date specified as such in the schedule

floating price means, in relation to a **calculation period**, the **final price** in dollars per **MWh** for that **calculation period** by reference to the **hedge reference point** [rounded to two decimal places]

hedge reference point means the **grid exit point** specified as such in the schedule

notional quantity means, in relation to a **calculation period**, the amount of **electricity** (measured in **MWh**) specified as such in the schedule for that **calculation period**

option buyer means, in relation to a **hedge settlement agreement**, the party specified as such in the schedule

option period means each period during the **term** specified as such in the schedule

option period floating amount means, in relation to an **option period**, an amount equal to the aggregate of the **calculation period floating amounts** for each **calculation period** in that **option period**

option period notional quantity means, in relation to an **option period**, the sum of the **notional quantities** for each **calculation period** in the **option period**

option period premium means, in relation to an **option period**, the sum of the **calculation period premium** for each **calculation period** in the **option period**

option period settlement amount means, in relation to an **option period**, an amount calculated using the following formula:

option period settlement amount = **option period notional quantity** x **strike price differential**

option premium means, in relation to a **billing period**, the sum of the **option period premiums** for each **option period** in that **billing period**

option seller means, in relation to a **hedge settlement agreement**, the party specified as such in the schedule

option type means either a put option or a call option as specified in the schedule

settlement date means the date on which payments are due under clause 14.31 of the Code

strike price means, in relation to an **option period**, the amount specified as such in the schedule

strike price differential means, in relation to an **option period**, an amount equal to:

- (a) if the **option type** is a put option, the greater of the **strike price** minus the **average floating price** and zero;
- (b) if the **option type** is a call option, the greater of the **average floating price** minus the **strike price** and zero

term means the period from 00.00 hours on the **commencement date** until 23.59 hours on the date on which the **hedge settlement agreement** terminates.

3 Payment of hedge settlement amounts

- (1) In relation to a **billing period**:
 - (a) the **option buyer** must pay the **clearing manager** an amount equal to the **option premium** for that **billing period**; and
 - (b) the **clearing manager** must pay the **option seller** an amount equal to the **option premium** for that **billing period**; and
 - (c) the **option seller** must pay the **clearing manager** an amount equal to the **cash settlement amount** for that **billing period**; and
 - (d) the **clearing manager** must pay the **option buyer** an amount equal to the **cash settlement amount** for that **billing period**, on the relevant **settlement date**.
- (2) In relation to a **billing period**, the **clearing manager** must calculate the amounts to be payable by and to the **parties** and advise each **party** of those amounts by the 5th **business day** of the month following the **billing period**. If either **party** notifies the **clearing manager** in writing by the 7th **business day** of the month following the **billing period** of any issues with the amounts the **clearing manager** has advised are to be payable, the **clearing manager** will use reasonable endeavours to correct the issues before issuing invoices on the 9th **business day** of the month following the **billing period** under clause 14.18(2) of the **Code**.

4 Termination

This **hedge settlement agreement** terminates on the earlier of:

- (a) the **expiry date**; and
- (b) the date on which it is cancelled under the **Code**.

5 Other provisions

- (1) The **strike price** is inclusive of any additional costs arising due to carbon charges.
- (2) Where the terms of this **hedge settlement agreement** include reference to—
 - (a) day, this means both **business days** and non-**business days**;
 - (b) weekday, this means a **business day**;
 - (c) weekend, this means non-**business days**.
- (3) Where daylight savings starts or ends during the **term** of this **hedge settlement agreement**, the **clearing manager** will calculate the **calculation period premium** and **option period settlement amounts** for these days in the same way the **clearing manager** calculates the sale and purchase of **electricity** for these days.

EXECUTION

[Execution Block Party A]

[Execution Block Party B]

The **clearing manager** accepts the lodgement of this **hedge settlement agreement** by counter-signing it.

[Execution Block Clearing Manager]

SCHEDULE TERMS OF HEDGE SETTLEMENT AGREEMENT

Hedge settlement agreement terms	
Commencement Date	[Insert date]
Expiry Date	[Insert date]
Option Buyer	[Party A] [Party B]
Option Seller	[Party A] [Party B]
Option Type	[Call Option] [Put Option]
Option Period	[Each day] [From 00.00 hours until immediately before 00.00 hours on the next day] [first period being nn and last period being mm] [during the term.]
Notional Quantity	[insert number MWh] [Table of Notional Quantities (in MWh per calculation period) to be inserted]
Strike Price	[\$[insert amount/ MWh] – [Table of Strike Prices to be inserted]
Calculation Period Premium	[\$[insert amount] for each calculation period of option period. [Table of Premiums to be inserted]

Electricity Industry Participation Code 2010
Schedule 14.4

Hedge Reference Point	[insert grid exit point]
------------------------------	---------------------------------

Schedule 14.4, Form 3, clause 2, formula in the definition of **average floating price**: amended, on 24 March 2015, by clause 22(1)(a) of the Electricity Industry Participation Code Amendment (Settlement and Prudential Security) 2014.

Schedule 14.4, Form 3, clause 2, formula in the definition of **calculation period floating amount**: amended, on 24 March 2015, by clause 22(1)(b) of the Electricity Industry Participation Code Amendment (Settlement and Prudential Security) 2014.

Schedule 14.4, Form 3, clause 2, definition of **calculation period notional quantity**: revoked, on 24 March 2015, by clause 22(1)(c) of the Electricity Industry Participation Code Amendment (Settlement and Prudential Security) 2014.

Schedule 14.4, Form 3, clause 2, definition of **calculation period premium**: inserted, on 24 March 2015, by clause 22(1)(d) of the Electricity Industry Participation Code Amendment (Settlement and Prudential Security) 2014.

Schedule 14.4, Form 3, clause 2, definition of **floating price**: amended, on 24 March 2015, by clause 22(1)(e) of the Electricity Industry Participation Code Amendment (Settlement and Prudential Security) 2014.

Schedule 14.4, Form 3, clause 2, definition of **notional quantity**: substituted, on 24 March 2015, by clause 22(1)(f) of the Electricity Industry Participation Code Amendment (Settlement and Prudential Security) 2014.

Schedule 14.4, Form 3, clause 2, definition of **option period notional quantity**: inserted, on 24 March 2015, by clause 22(1)(g) of the Electricity Industry Participation Code Amendment (Settlement and Prudential Security) 2014.

Schedule 14.4, Form 3, clause 2, definition of **option period premium**: substituted, on 24 March 2015, by clause 22(1)(h) of the Electricity Industry Participation Code Amendment (Settlement and Prudential Security) 2014.

Schedule 14.4, Form 3, clause 2, formula in the definition of **option period settlement amount**: amended, on 24 March 2015, by clause 22(1)(i) of the Electricity Industry Participation Code Amendment (Settlement and Prudential Security) 2014.

Schedule 14.4, Schedule to Form 3: amended, on 24 March 2015, by clause 22(2) of the Electricity Industry Participation Code Amendment (Settlement and Prudential Security) 2014.

Schedule 14.4, Form 3, clause 2 **business day**: inserted, on 1 March 2024, by clause 106 of the Electricity Industry Participation Code Amendment (Code Review Programme) 2024.

Schedule 14.4, Form 3, clause 3(2): inserted, on 1 March 2024, by clause 107 of the Electricity Industry Participation Code Amendment (Code Review Programme) 2024.

Schedule 14.4, Form 3, clause 5: amended, on 1 March 2024, by clause 108 of the Electricity Industry Participation Code Amendment (Code Review Programme) 2024.

Electricity Industry Participation Code 2010

Part 14A Prudential requirements

Part 14A: inserted, on 24 March 2015, by clause 20 of the Electricity Industry Participation (Settlement and Prudential Security) Code Amendment 2013.

Contents

14A.1	Purpose of prudential requirements
14A.2	Participants to comply with prudential requirements
14A.3	Acceptable credit rating
14A.4	Acceptable security
14A.5	Clearing manager to determine estimate of minimum security
14A.6	Participant to provide minimum security required
14A.7	Participant may change form of security
14A.8	Reductions and releases
14A.9	Release of security on ceasing to be participant
14A.10	Clearing manager to release security within 1 business day <i>Cash deposits to be held on trust</i>
14A.11	Cash deposit accounts
14A.12	Cash deposits to be paid into cash deposit accounts
14A.13	Cash deposits to be applied subject to conditions
14A.14	Interest on cash deposits
14A.15	Fees and taxes payable by participants <i>Information, monitoring and reporting</i>
14A.16	Information required from new purchasers
14A.17	Participants subject to prudential requirements to provide information to clearing manager
14A.18	System operator to provide information
14A.19	Clearing manager to keep information confidential
14A.20	Clearing manager to provide information about cash deposits
14A.21	Clearing manager to provide information about required security
14A.22	Clearing manager to keep register of specified time periods <i>Disputes</i>
14A.23	Disputes regarding prudential requirements <i>Notices</i>
14A.24	Notices

Schedule 14A.1 Acceptable security

Schedule 14A.2 Guarantee

Schedule 14A.3 Deed of guarantee and indemnity

**Schedule 14A.4
Letter of credit**

**Schedule 14A.5
Surety bond**

14A.1 Purpose of prudential requirements

The purpose of this Part is to impose prudential requirements on each **participant** that has incurred or will incur financial obligations under this Code to ensure that the **participant** can meet those obligations.

14A.2 Participants to comply with prudential requirements

- (1) Before incurring any financial obligations under this Code, a **participant** must comply with prudential requirements in this Part.
- (2) A **participant** complies with prudential requirements in this Part in 1 of the following ways:
 - (a) by maintaining an acceptable credit rating under clause 14A.3:
 - (b) by providing acceptable security that complies with clause 14A.4.

14A.3 Acceptable credit rating

- (1) For the purposes of this Part, a person has an acceptable credit rating if—
 - (a) the person has a long-term credit rating no lower than—
 - (i) A3 (Moody's Investor Services Inc.); or
 - (ii) A– (Standard & Poor's Rating Group); or
 - (iii) B+ (AM Best); or
 - (iv) A– (Fitch Ratings); and
 - (b) in the case of a person who has a credit rating at the minimum level required under paragraph (a), the person is not subject to negative credit watch (or any equivalent arrangement) by the agency that gave the credit rating.
- (2) The **clearing manager** may require a **participant** whose compliance with prudential requirements in this Part depends on the credit rating of a person to provide evidence of the person's credit rating.
- (3) The **participant** must provide the evidence required by the **clearing manager**.

14A.4 Acceptable security

- (1) A **participant** provides acceptable security by—
 - (a) providing an acceptable form of security in accordance with Part 1 of Schedule 14A.1; and
 - (b) providing security for an amount that is no less than the amount required under clause 14A.6.
- (2) A **participant** that provides acceptable security must do anything the **Authority** requires to ensure that the security is valid, enforceable, and effective.

14A.5 Clearing manager to determine estimate of minimum security

- (1) At least once in every **business day**, the **clearing manager** must estimate the minimum amount for which security will be required to be provided by a **participant** under this Part on that **business day** and on each of the following 3 **business days** in accordance with Part 2 of Schedule 14A.1.
- (2) The **clearing manager** must formulate and **publish** a methodology for estimating the amounts under subclause (1).
- (3) The consultation and approval requirements set out in Schedule 14.2 apply to the methodology.

14A.6 Participant to provide minimum security required

- (1) Each **participant** that is required to provide acceptable security under this Part on a **business day** must provide security for an amount that is the lowest of all of the estimates determined by the **clearing manager** for the **participant** for that **business day**.
- (2) The **participant** must provide security for the amount required under subclause (1) no later than 1600 hours on the relevant **business day**.

14A.7 Participant may change form of security

The **clearing manager** must release a **participant's** existing security when the **participant** provides a different form of security under this clause, if—

- (a) the **participant** gives the **clearing manager** notice of its intention to substitute a different form of security for any security provided by it to the **clearing manager**; and
- (b) no **event of default** is continuing in relation to the **participant**; and
- (c) the **participant** satisfies the **clearing manager** that—
 - (i) the proposed new form of security is an acceptable form of security under Part 1 of Schedule 14A.1; and
 - (ii) the security provided by the **participant** will continue to be for an amount that is no less than the amount required under clause 14A.6.

Clause 14A.7: amended, on 1 November 2018, by clause 107 of the Electricity Industry Participation Code Amendment (Code Review Programme) 2018.

14A.8 Reductions and releases

The **clearing manager** must reduce or release a **participant's** existing security to the extent requested by the **participant**, if—

- (a) the **participant** gives the **clearing manager** notice that it seeks a partial or complete reduction or release of any security provided by it to the **clearing manager**; and
- (b) no **event of default** is continuing in relation to the **participant**; and
- (c) the **participant** satisfies the **clearing manager** that, following the reduction or release of the security, the **participant** will—
 - (i) continue to meet the requirements in clause 14A.4; or
 - (ii) meet the requirements in clause 14A.3.

14A.9 Release of security on ceasing to be participant

The **clearing manager** must release a **participant's** existing security if the **participant**—

- (a) gives the **clearing manager** notice of it ceasing to be a **participant**; and
- (b) ceases to be a **participant** and the **Authority** advises the **clearing manager** that the person has ceased to be a **participant**; and
- (c) has paid all amounts that it owes under this Code (excluding any **washup** amount that has not yet been invoiced).

14A.10 Clearing manager to release security within 1 business day

- (1) If a **participant** becomes entitled under clause 14A.7 or 14A.8 or 14A.9 or 14A.23 to a reduction or release of any security, the **clearing manager** must reduce or release that security within 1 **business day** of the **participant** becoming entitled to the reduction or release.
- (2) If a **cash deposit** is to be reduced or refunded under subclause (1), the **clearing manager** must pay the amount of the reduction or refund to a **bank** account nominated by the **participant** for that purpose.

Cash deposits to be held on trust

14A.11 Cash deposit accounts

- (1) The **clearing manager** must establish, in the **clearing manager's** name, 2 or more interest bearing **cash deposit accounts**.
- (2) The **cash deposit accounts** must be—
 - (a) held with more than 1 **bank** that each has and maintains an acceptable credit rating in accordance with clause 14A.3(1); and
 - (b) clearly identified as such and be entirely separate from any other **bank** account of the **clearing manager**.
- (3) The **clearing manager** must obtain acknowledgement from each **bank** with which it has a **cash deposit account** that—
 - (a) the **cash deposits** are held on trust in the **cash deposit accounts** for **participants** (including the **clearing manager**) that become entitled to receive money from the **clearing manager** from time to time under clause 14A.13; and
 - (b) the **bank** has no right of set-off or right of combination in relation to the **cash deposits**.

14A.12 Cash deposits to be paid into cash deposit accounts

- (1) Every **cash deposit** received by the **clearing manager** must be paid by the **clearing manager** immediately into the **cash deposit accounts**.
- (2) Each **cash deposit** must be held between **cash deposit accounts** in approximately equal amounts.
- (3) If a **cash deposit** is debited under this Part, the **clearing manager** must ensure that approximately equal amounts of the **cash deposit** are debited from each **cash deposit account**.

14A.13 Cash deposits to be applied subject to conditions

The **clearing manager** must hold each **cash deposit** in the **cash deposit accounts** on trust to be applied, subject to this Code, only in accordance with the following:

- (a) following any **event of default**, the **clearing manager** must use such amount of the defaulting **participant's cash deposit** as is necessary or available in order to satisfy (to the extent possible) any amounts that may be due and owing by the defaulting **participant** to the **clearing manager** under this Code:
- (b) if no **event of default** is continuing in relation to the **participant** that provided the **cash deposit**, the **participant** is entitled to be paid the part of the **cash deposit** that has not been transferred under paragraph (a) in accordance with clause 14A.7 or 14A.8 or 14A.9 or 14A.23:
- (c) to satisfy an amount payable under clause 14.31 if the **participant** satisfies the **clearing manager** that, immediately following the application of the **cash deposit**, it will continue to comply with prudential requirements in this Part:
- (d) the **participant** is not entitled to receive back any part of its **cash deposit**, other than in accordance with this clause, even if the **participant** is in liquidation, receivership, or subject to statutory management or other analogous situation.

14A.14 Interest on cash deposits

- (1) Subject to clauses 14A.13 and 14A.15, the **clearing manager** must credit to each **participant** on behalf of which the **clearing manager** holds a **cash deposit** all interest received by the **clearing manager** on the **cash deposit**, less any applicable deduction for tax purposes.
- (2) Subject to subclause (3), if a **participant** does not wish the interest to accumulate in the **cash deposit accounts**, the **clearing manager** must, at the request of the **participant**, pay the interest (less any applicable deduction for tax purposes) within 2 **business days** of the end of the month to a **bank** account nominated by the **participant** for this purpose.
- (3) Subclause (2) does not apply if an **event of default** has occurred in relation to the **participant** and is continuing.

14A.15 Fees and taxes payable by participants

- (1) A **participant** is liable to reimburse the **clearing manager** for all **bank** fees in relation to its **cash deposit** and any taxes that may from time to time be imposed either on its **cash deposit** or on interest earned on such **cash deposit**.
- (2) Such payments must be deducted by the **clearing manager** from any amounts paid to the **participant** under clause 14A.14(2).
- (3) If the amounts are less than the payments owed by the **participant** under this clause, the shortfall must be invoiced separately by the **clearing manager**.

Information, monitoring, and reporting

14A.16 Information required from new purchasers

Before a new **purchaser** purchases **electricity**, it must submit to the **clearing manager**—

- (a) historical records of the quantity of **electricity** purchased and sold by that person before that person became a **purchaser**; or
- (b) if the **clearing manager** is not satisfied with records provided under paragraph (a), or if there are no such records, a bona fide **business** plan prepared in good faith to permit a realistic estimate of the **purchaser's** future trading.

14A.17 Participants subject to prudential requirements must provide information to clearing manager

- (1) The **clearing manager** may require a **participant** that is required to comply with prudential requirements in this Part to provide, by any date specified by the **clearing manager**, any information that the **clearing manager** requires for the purposes of carrying out its functions under this Part.
- (2) A **participant** that is required to provide information to the **clearing manager** under subclause (1) must provide the information to the **clearing manager** by the date specified by the **clearing manager**.
- (3) Each **participant** that is required to comply with prudential requirements under this Part must provide the following information to the **clearing manager** immediately upon the **participant** becoming aware of the situation:
 - (a) if the **participant** is a **purchaser**, any significant change to that **purchaser's** **business**, including a merger or acquisition, loss or gain of a customer, or sale or purchase of assets, that could significantly affect the quantity of **electricity** purchased or generated by the **participant** in its capacity as a **purchaser** or **generator**;
 - (b) any change or likely change to the **participant's** credit rating (if the **participant** has a credit rating), regardless of whether or not the **participant** is relying on a credit rating as a prudential requirement in terms of clause 14A.3;
 - (c) if a letter of credit or guarantee or bond is provided in respect of the **participant** in accordance with Part 1 of Schedule 14A.1—
 - (i) any change or likely change to the credit rating of the provider of the guarantee, letter of credit, or bond such that the provider's credit rating would, as a result, not be an acceptable credit rating as defined in clause 14A.3; or
 - (ii) any claim by the provider of the guarantee, letter of credit, or bond that the guarantee, letter of credit, or bond has ceased to be valid and enforceable.
- (4) If, at any time, a **participant** believes that its ability to pay an amount owing to the **clearing manager** under this Code is or is likely to be materially adversely affected, the **participant** must provide the **clearing manager** with details of that fact immediately.

Clause 14A.17(3)(a): amended, on 1 November 2018, by clause 108 of the Electricity Industry Participation Code Amendment (Code Review Programme) 2018.

14A.18 System operator to provide information

The **system operator** must provide the **clearing manager** with the following information immediately upon becoming aware of the information:

- (a) any likely significant change to any amount to be allocated to a **participant** in respect of **ancillary services**;
- (b) the amount incurred by a **participant** as a result of the **participant** causing an **under-frequency event**.

Clause 14A.18(a): amended, on 24 March 2015, by clause 31 of the Electricity Industry Participation Code Amendment (Extended Reserve) 2014.

Clause 14A.18(a): amended, on 21 December 2021, by clause 39 of the Electricity Industry Participation Code Amendment (Automatic Under-Frequency Load Shedding Systems) 2021.

14A.19 Clearing manager to keep information confidential

The **clearing manager** must keep all information received by it under clauses 14A.16 to 14A.18 confidential and must not disclose it to any other person except—

- (a) with the written consent of the person who provided the information; or
- (b) if the information is required to be disclosed to or by the **Rulings Panel** or the **Authority** under this Code, regulations made under section 112 of the **Act**, or any other law.

14A.20 Clearing manager to provide information about cash deposits

Each month the **clearing manager** must provide each **participant** that has provided a **cash deposit** with a statement regarding the balance of the **participant's cash deposit**.

14A.21 Clearing manager to provide information about required security

- (1) The **clearing manager** must provide each **participant** that is required to comply with prudential requirements under this Part with information about the amount for which security is required to be provided by the **participant** under clause 14A.6.
- (2) The **clearing manager** must—
 - (a) provide the information to the **participant** through **WITS**; and
 - (b) **publish** the information.

Clause 14A.21(2): replaced, on 5 October 2017, by clause 510 of the Electricity Industry Participation Code Amendment (Code Review Programme) 2017.

14A.22 Clearing manager to keep register of specified time periods

- (1) The **clearing manager** must keep a register of the following time periods for each **participant** that is required to comply with prudential requirements in this Part (except a **participant** to which subclause (2) applies):
 - (a) a prudential exit period determined in accordance with subclause (3);
 - (b) a post-default exit period determined in accordance with subclause (4).
- (2) The **clearing manager** is not required to keep a register of time periods for a **participant** that is required to comply with prudential requirements in this Part only because the **participant** has an obligation in relation to 1 or more **FTRs**.
- (3) The prudential exit period for a **participant** is the number of **trading days** that elapse over the sum of the following:
 - (a) **1 trading day**;
 - (b) the post-default exit period for the **participant**.

- (4) The post-default exit period for a **participant** is as follows, unless the **Authority** has approved a shorter period requested by the **participant**:
- (a) for a **retailer**, 18 **trading days**;
 - (b) for a **direct purchaser**, 7 **trading days**;
 - (c) for a **participant** that is not a **retailer** or a **direct purchaser**, 7 **trading days**.
- (5) The post-default exit period for a **participant** begins from the day on which the **participant** advises the **clearing manager** or the **clearing manager** advises the **participant** under clause 14.43 that an **event of default** has occurred in relation to the **participant**.
- (6) A **participant** that has a shorter post-default exit period approved by the **Authority** may increase the period to no more than the number of **trading days** set out in subclause (4) by giving 20 **business days'** notice to the **clearing manager**.
- (7) A shorter post-default exit period approved by the **Authority** takes effect 20 **business days** after the date of the **Authority's** approval.
- (8) If the **Authority** has approved a shorter post-default exit period for a **participant**—
- (a) the **participant** must immediately advise the **Authority** if the **participant's** circumstances change such that the criteria against which the **Authority** approved the shorter post-default exit period may no longer be met;
 - (b) the **clearing manager** must immediately advise the **Authority** if the **clearing manager** becomes aware that the **participant's** circumstances have changed such that the criteria against which the **Authority** approved the shorter post-default exit period may no longer be met;
 - (c) if the **Authority** considers the **participant's** circumstances have changed such that the criteria against which the **Authority** approved the **participant** having a shorter post-default exit period are no longer met, the **Authority** may—
 - (i) amend the **participant's** post-default exit period; or
 - (ii) rescind its approval of the shorter post-default exit period for the **participant**.
- (9) If the **Authority** amends or rescinds its approval of a **participant's** shorter post-default exit period, the **Authority** must—
- (a) give the **participant** at least 1 month's notice in writing before the amendment or the rescission comes into effect; and
 - (b) advise the **participant** of the reasons for amending or rescinding the approval.
- Clause 14A.22(4): amended, on 1 November 2018, by clause 109(1) of the Electricity Industry Participation Code Amendment (Code Review Programme) 2018.
Clause 14A.22(6): amended, on 20 December 2021, by clause 64 of the Electricity Industry Participation Code Amendment (Code Review Programme) 2019.
Clause 14A.22(8) and (9): inserted, on 1 November 2018, by clause 109(2) of the Electricity Industry Participation Code Amendment (Code Review Programme) 2018.

Disputes

14A.23 Disputes regarding prudential requirements

- (1) A **participant** that disputes a decision of the **clearing manager** under this Part may refer the dispute to the **Rulings Panel**.
- (2) Until such time as the **Rulings Panel** makes a decision on the dispute, all **participants** must comply with the relevant decision of the **clearing manager**.
- (3) If a dispute is referred to it under subclause (1), the **Rulings Panel** must, after hearing

from the **participant** that disputed the **clearing manager's** decision and from the **clearing manager**, make a decision in accordance with this Part.

- (4) If the **Rulings Panel** overturns or varies a decision by the **clearing manager**, the **clearing manager's** original decision, and the process that led to that decision, is not a breach of this Code by the **clearing manager**, unless the **Rulings Panel** determines that the **clearing manager's** decision was made negligently or in bad faith.

Notices

14A.24 Notices

- (1) Except as expressly provided in this Code, a notice or demand given or required to be given under this Part may be given by being delivered or transmitted to the intended recipient at its address or electronic address as last advised in writing to the sender and may be posted to such address by prepaid post.
- (2) Subject to subclause (3),—
- (a) a notice or demand delivered by hand is deemed to be delivered on the date of such delivery; and
 - (b) a notice or demand delivered by post is deemed to be delivered on the 2nd **business day** following the date of posting; and
 - (c) a notice or demand transmitted through **WITS** is deemed to be delivered on the date it was transmitted.
- (3) Any notice or demand delivered, or deemed to be delivered, on a day that is not a **business day**, or after 1600 hours on a **business day**, is deemed to have been delivered on the next **business day**.

Clause 14A.24(2)(c): amended, on 5 October 2017, by clause 511 of the Electricity Industry Participation Code Amendment (Code Review Programme) 2017.

Schedule 14A.1 Acceptable security

cl 14A.4

Part 1 Acceptable forms of security

1 Acceptable forms of security

A **participant** may provide acceptable security in any of the following forms:

- (a) a **cash deposit** (see clause 2):
- (b) an unconditional guarantee or letter of credit (see clause 3):
- (c) a security bond (see clause 4):
- (d) another form of security (see clause 5):
- (e) a combination of the forms of security listed in paragraphs (a) to (d) that in aggregate secures the required amount.

2 Cash deposit

- (1) A **participant** must pay a **cash deposit** into the **cash deposit accounts** or to the **clearing manager**.
- (2) The **participant** must provide and maintain an acceptable **participant's** security agreement in respect of the **cash deposit**.
- (3) A **participant's** security agreement must—
 - (a) be a security agreement as defined in section 16(1) of the Personal Property Securities Act 1999; and
 - (b) create a first ranking security interest in respect of the **cash deposit**; and
 - (c) secure the **participant's** payment and performance obligations to the **clearing manager** under this Code; and
 - (d) be in a form approved by the **Authority**.

3 Guarantee or letter of credit

- (1) A guarantee or letter of credit must be given in favour of the **clearing manager**.
- (2) A letter of credit is an acceptable form of security only if it is given by a **bank**.
- (3) A guarantee or letter of credit must be given on terms as follows, or as otherwise approved by the **Authority**:
 - (a) for a guarantee given by a **bank**, the terms in Schedule 14A.2:
 - (b) for a guarantee given by another person, the terms in Schedule 14A.3:
 - (c) for a letter of credit, the terms in Schedule 14A.4.
- (4) A guarantee or letter of credit is an acceptable form of security only while the person giving it has an acceptable credit rating as defined in clause 14A.3.

4 Security bond

- (1) A security bond must be given in favour of the **clearing manager**.
- (2) A security bond must be given on the terms in Schedule 14A.5 or as otherwise approved by the **Authority**.
- (3) A security bond is an acceptable form of security only while the surety has an

acceptable credit rating as defined in clause 14A.3.

5 Other security

- (1) Any other form of security is an acceptable form of security only if it has been approved by the **Authority**.
- (2) The **Authority** may approve another form of security if the **Authority** is satisfied that the form of security ensures that the relevant **participant** can meet its financial obligations under the Code to the same extent as if the **participant** provided a form of security specified in paragraphs (a) to (d) of clause 1.

Part 2 Minimum security

6 Determining minimum security

- (1) The minimum amount for which security is required to be provided by a **participant** under clause 14A.6 is—
 - (a) the sum of the following amounts:
 - (i) the general prudential requirement calculated in accordance with clause 7;
 - (ii) the **FTR** prudential requirement calculated in accordance with clause 11; minus
 - (b) any amount prepaid by the **participant** under clause 14.30 that is specified by the **participant** as being for a **billing period**—
 - (i) that has commenced but remains unsettled on the day for which the minimum security is being determined; or
 - (ii) any part of which falls within the prudential exit period for the **participant** (if any).
- (2) If the sum of the amounts under subclause (1) is negative, the minimum amount for which security is required to be provided is 0.

Clause 6(1)(b): substituted, on 24 March 2015, by clause 23 of the Electricity Industry Participation Code Amendment (Settlement and Prudential Security) 2014.

7 General prudential requirement

The general prudential requirement is the sum of the following amounts calculated in accordance with the methodology approved under clause 8:

- (a) the expected amount of the **clearing manager's** outstanding financial exposure to the **participant**; and
- (b) the exit period prudential margin for the **participant**.

8 Methodology for determining general prudential requirement amounts

- (1) The **clearing manager** must formulate and **publish** a methodology for determining the amounts specified in clause 7.
- (2) The methodology must comply with the requirements specified in clauses 9 and 10.
- (3) The consultation and approval requirements set out in Schedule 14.2 apply to the methodology.

9 Calculating clearing manager's outstanding financial exposure to participant

- (1) The expected amount of the **clearing manager's** outstanding financial exposure to a **participant** on any **trading day** is an estimate of all unsettled amounts owing by the **participant** to the **clearing manager** and by the **clearing manager** to the **participant** to the end of the previous **trading day**, including the **clearing manager's** estimate of the following amounts:
- (a) the amount owing to or by the **participant** for purchasing and selling **electricity**;
 - (ab) *[Revoked]*;
 - (b) the amount owing to or by the **participant** in relation to **ancillary services**;
 - (c) the net amount owing to or by the **participant** in respect of any **hedge settlement agreement** lodged with the **clearing manager** under clause 14.8;
 - (d) the amount of any **GST** payable by the **participant** in respect of the above amounts.
- (2) The **clearing manager** must use **final prices** in calculating amounts under subclause (1) unless—
- (a) **final prices** are not available, in which case the **clearing manager** must use **interim prices**; or
 - (b) neither **final prices** nor **interim prices** are available, or an **undesirable trading situation** has been claimed in respect of a **trading period** or **trading day** that is included in the **clearing manager's** estimate, in which case the **clearing manager** must use the price calculated in accordance with clause 10(2)(c) that is used in the methodology for determining the exit period prudential margin.
- (3) The **clearing manager** must take **washup** amounts that have been advised as owing under Part 14 into account in estimating the amounts described in this clause.

Clause 9(1)(ab): inserted, on 24 March 2015, by clause 32 of the Electricity Industry Participation Code Amendment (Extended Reserve) 2014.

Clause 9(1)(ab): revoked, on 21 December 2021, by clause 40 of the Electricity Industry Participation Code Amendment (Automatic Under-Frequency Load Shedding Systems) 2021.

Clause 9(3): amended, on 24 March 2015, by clause 24 of the Electricity Industry Participation Code Amendment (Settlement and Prudential Security) 2014.

10 Exit period prudential margin

- (1) The exit period prudential margin for a **participant** is the **clearing manager's** estimate of the amount that the **participant** will incur and earn during the prudential exit period for the **participant** in respect of the following:
- (a) the sale and purchase of **electricity**;
 - (ab) *[Revoked]*;
 - (b) **ancillary services**;
 - (c) any **hedge settlement agreement** lodged with the **clearing manager** under clause 14.8;
 - (d) any **GST** payable in respect of the above amounts.
- (2) The estimated amounts to be incurred and earned by the **participant** in respect of the sale and purchase of **electricity** under subclause (1)(a) are based on—
- (a) the number of **trading days** in the prudential exit period for the **participant** determined under clause 14A.22(3); and
 - (b) the expected value of **electricity** to be purchased by the **participant** minus the

- expected value of **electricity** to be sold by the **participant** during that period based on the prices in paragraph (c); and
- (c) the sum of the following amounts:
- (i) the prices of **electricity** expected to apply during the quarter to which the calculation relates in accordance with subclauses (3) and (4):
 - (ii) an amount determined as set out in subclause (5).
- (3) In determining the prices under subclause (2)(c)(i), the **clearing manager** must use prices of **electricity** futures products that are available and that the **clearing manager** considers provide a reasonable estimate of the average price of **electricity** for the relevant quarter.
- (4) The **clearing manager** must determine the prices under subclause (2)(c)(i)—
- (a) for each quarter beginning 1 January, 1 April, 1 July, and 1 October; and
 - (b) no later than 2 months before the beginning of each quarter.
- (5) The amount determined under subclause (2)(c)(ii) must—
- (a) be an amount expressed in \$/MWh of not less than \$0/MWh; and
 - (b) be determined on the basis that the exit period prudential margin for a hypothetical **purchaser** that purchases a constant proportion of total **electricity** purchased from the **clearing manager** for every **trading period** is greater than the general exit period exposure for the **purchaser** on 75% of the days in a modeling period of 3 to 10 years selected by the **clearing manager**.
- (6) The **clearing manager** must determine the amount under subclause (2)(c)(ii)—
- (a) once for each calendar year; and
 - (b) no later than 2 months before the beginning of each calendar year.
- (7) The methodology must specify how the clearing manager will estimate the initial amount of security for **ancillary services** for a new **participant**.
- (8) The expected amounts to be incurred and earned by the **participant** in respect of a **hedge settlement agreement** must be based on the price determined by the **clearing manager** under subclause (2)(c).

Clause 10(1)(ab): inserted, on 24 March 2015, by clause 33 of the Electricity Industry Participation Code Amendment (Extended Reserve) 2014.

Clause 10(1)(ab): revoked, on 21 December 2021, by clause 41 of the Electricity Industry Participation Code Amendment (Automatic Under-Frequency Load Shedding Systems) 2021

Clause 10(5)(b): amended, on 24 March 2015, by clause 25(1) of the Electricity Industry Participation Code Amendment (Settlement and Prudential Security) 2014.

Clause 10(6)(a): amended, on 24 March 2015, by clause 25(2) of the Electricity Industry Participation Code Amendment (Settlement and Prudential Security) 2014.

11 FTR prudential requirement

The **FTR** prudential requirement for a **participant** is the sum of the following amounts:

- (a) the **clearing manager's** estimate of an amount to be incurred or earned by the **participant** in respect of any **FTR** in respect of which the **participant** is named in the **FTR register**, calculated in accordance with the methodology approved by the **Authority** under clause 12:
- (b) the amount of any **FTR acquisition cost** in respect of an **FTR** held by the **participant**:

- (c) any amount payable by the **participant** to the **clearing manager** under clause 13.249(4) minus any amount payable by the **clearing manager** to that **participant** under clause 13.249(7).

12 Methodology for determining minimum security required in respect of FTRs

- (1) The **clearing manager** must formulate and **publish** a methodology for determining the minimum amount for which security is required to be provided in relation to a matter set out in clause 11(a).
- (2) The methodology formulated by the **clearing manager** under subclause (1) must comply with the principle that the amount taken into account under clause 11(a) is an estimate of the **FTR hedge value** (being an amount that may be positive or negative) of the **FTR** at the time that the estimate is made and the potential for that value to change before the **clearing manager** is able to realise the value of the **FTR** following an **event of default** occurring in relation to the holder of the **FTR**.
- (3) The consultation and approval requirements set out in Schedule 14.2 apply to the methodology.

13 Information to be considered by clearing manager

In estimating the amounts described in this Part, the **clearing manager** may take into account a substantial change to a **participant's business**.

Schedule 14A.2 Guarantee

Schedule 14A.1, cl 3

To: [Clearing manager] (the "Clearing Manager")
[address]

Attention: [name]

Dear Sir/Madam

1. [Bank] (the "Bank") refers to each obligation of [Participant] (the "Principal") to pay amounts the Principal, now or at any time, owes to, and is invoiced by, the Clearing Manager (whether as principal or agent) together with default interest, if any, in relation to such amounts (the "Obligations") under the Electricity Industry Participation Code 2010 (the "Code").
2. The Bank unconditionally guarantees to pay the Clearing Manager an amount specified in each such demand provided that—

[a] [the Bank's liability under this guarantee will not exceed \$[insert amount] (the "Maximum Amount"); and]

[Note: Bank to elect either this paragraph or the following paragraph].

[a] the Bank's liability under this guarantee will not exceed the Maximum Amount as defined below—

- (i) The sum of the amounts calculated for all trading periods to which this guarantee applies in any period to which a demand under this guarantee relates in accordance with the following formula:

$$A * B$$

where

A is [X] MWh

B is the final price for the trading period at the [specify] [grid injection point/grid exit point/reference point]; and

- (ii) For the purposes of paragraph 2(a)(i), this guarantee applies to every trading period within any period to which a demand under this guarantee relates as follows:

A. From the "Starting Date", being the later of—

1. the start of the period; and
2. [date]; and

B. Until the "Final Date", being the earlier of—

1. the end of the period; and

2. the Final Date as notified to the Clearing Manager under paragraph 2(a)(iii); and
 3. [date]; and
- (ii) Despite anything in this guarantee or in the Code, the Bank may give the Clearing Manager notice of the Final Date for the purposes of paragraph 2(a)(ii)B. The Final Date is the later of the date specified in the notice or two business days after the date on which the Clearing Manager receives the notice; and]
- (b) the Clearing Manager's demand is made in writing and is signed by or purported to be signed by an authorised signatory; and
 - (c) a certificate signed by or purported to be signed by the Clearing Manager's authorised signatory and certifying that the Principal has failed, in whole or in part, to fulfil the Obligations accompanies the demand, such certificate will be conclusive proof of such failure.
3. The Bank's liability under this guarantee will not be affected, discharged, or diminished by any act, omission, or matter, which, but for this provision, would have affected, discharged, or diminished a guarantor's liability, but would not have affected, discharged, or diminished the Bank's liability had it been a principal debtor, including:
- (a) the insolvency, liquidation, or dissolution of the Principal or any other person, the appointment of any receiver, manager, inspector, trustee, statutory manager, or other similar person in respect of the Principal or any other person, or any change in the Principal's status, function, control, or ownership; and
 - (b) any of the Obligations, or the obligations of any person under any security or guarantee held in relation to any of the Obligations, being or becoming in whole or in part void, voidable, defective, illegal, invalid, or unenforceable in any respect or ranking after any other security; and
 - (c) any time, credit or other indulgence or other concession being granted or agreed to be granted by the Clearing Manager to, or any composition or other arrangement made with or accepted from, the Principal in respect of any of the Obligations or the obligations of any person under any security or guarantee held in relation to the same; and
 - (d) any variation of the terms of any of the Obligations or of any security or guarantee (including under this guarantee) held in relation to the same; and
 - (e) any failure to realise or fully realise the value of, or any release, discharge, exchange, or substitution of, any security or guarantee held in relation to any of the Obligations; and
 - (f) any failure (whether intentional or not) to take, fully take or perfect any security now or in the future agreed to be taken by the Clearing Manager in relation to any of the Obligations; and
 - (g) any other act, event or omission that, but for this clause 3, would or might operate or discharge, impair, or otherwise affect any of the obligations of the

Guarantor under this guarantee or any of the rights, powers, or remedies conferred upon the Clearing Manager by the rules or by law.

4. Subject to paragraph 5 below, this guarantee will continue in force until the date at which the Principal ceases to be bound by the Code and has discharged its obligations to the Clearing Manager under the Code, at which time the Clearing Manager will return this guarantee to the Bank.
- [5. Despite anything else in this guarantee, the Bank may at any time pay the Clearing Manager the Maximum Amount less any amount or amounts the Bank may previously have paid under this guarantee or such lesser sum as the Clearing Manager may require. Upon payment of that sum, this guarantee shall be cancelled and the Bank shall have no further liability.]

[Note: Bank to elect either this paragraph or the following paragraph as a method of cancellation.]

- [5. Despite anything else in this guarantee, the Bank may cancel this guarantee by giving 90 days' notice in writing to the Clearing Manager. Following cancellation of this guarantee, the Bank remains liable for any Obligations incurred before the effective date of cancellation, but shall not be liable for any Obligations incurred after that date.]
6. This guarantee may be assigned by the Clearing Manager without the Bank's consent. It will bind the successors and assigns of the Bank.
7. This guarantee is governed by New Zealand law and the parties irrevocably submit to the non-exclusive jurisdiction of the courts of New Zealand.

[insert execution block for Bank]

Schedule 14A.2: replaced, on 1 November 2018, by clause 110 of the Electricity Industry Participation Code Amendment (Code Review Programme) 2018.

Schedule 14A.3 Deed of guarantee and indemnity

Schedule 14A.1, cl 3

DATED

BY

1. [Guarantor] (the "Guarantor")

IN FAVOUR OF

2. [Clearing manager] (the "Beneficiary")

1. **Guarantee and indemnity**

1.1 The Guarantor—

- (a) unconditionally and irrevocably guarantees to the Beneficiary the due performance and observance by [Participant] (the "Debtor") of each obligation the Debtor may now or in the future have to the Beneficiary to pay amounts it owes to, and is invoiced by, the Beneficiary (whether as principal or agent) together with default interest, if any, in relation to such amounts (the "Obligations") under the Electricity Industry Participation Code 2010 (the "Code"); and
- (b) indemnifies the Beneficiary against any loss incurred by the Beneficiary as a result of any failure by the Debtor to fulfil the Obligations. This indemnity shall apply to any of the Obligations (or any amount which, if recoverable, would have formed part of the Obligations) which is not or may not be enforceable, recoverable, or recovered for any reason; and
- (c) shall pay the Obligations (and any other amounts owing under this Deed) on demand.

1.2 The total amount payable by the Guarantor under this Deed must not exceed the aggregate of \$[insert amount] (the "Maximum Amount") and any sums payable under clauses 1.3 and 9 of this Deed.

1.3 If any moneys payable by the Guarantor under this Deed are not paid on demand, the Guarantor must pay to the Beneficiary interest on such unpaid moneys (both before and after judgment) at the rate determined in accordance with clause 1.4 of this Deed from the date of demand to the date of their actual receipt by the Beneficiary calculated on a daily basis and capitalised as the Beneficiary will determine.

1.4 The interest rate will be 5% per annum plus the then prevailing settlement bid rate for 90 day bills displayed on Reuters Screen BKBM at 10:45am on the date of demand or, if for any reason that rate is not displayed, the rate determined by the Beneficiary to be the nearest practicable equivalent.

2. Preservation of rights

- 2.1 The obligations of the Guarantor and the rights, powers and remedies conferred on the Beneficiary under this Deed are in addition to, and not in substitution for, any other security or guarantee that the Beneficiary may at any time hold in respect of the Obligations and may be enforced without the Beneficiary first having recourse to any such security and without the Beneficiary first taking steps or proceedings against the Debtor.
- 2.2 The Guarantor's liability and the rights, powers, and remedies conferred on the Beneficiary under this Deed will not be affected, discharged, or diminished by (and the Guarantor waives notice of) any act, omission or matter which, but for this clause 2.2, would have affected, discharged or diminished the Guarantor's liability to the Beneficiary or the Beneficiary's rights, powers and remedies with respect to the Guarantor or would have otherwise provided a defence to the Guarantor (in each case, in whole or in part), including—
- (a) the insolvency, liquidation, or dissolution of the Debtor or any other person, the appointment of any receiver, manager, inspector, trustee, statutory manager, or other similar person in respect of the Debtor or any other person, or any change in the Debtor's status, function, control, or ownership; and
 - (b) any of the Obligations, or the obligations of any person under any security or guarantee held in relation to any of the Obligations, being or becoming in whole or in part void, voidable, defective, illegal, invalid, or unenforceable in any respect or ranking after any other security; and
 - (c) any time, credit or other indulgence or other concession being granted or agreed to be granted by the Beneficiary to, or any composition or other arrangement made with or accepted from, the Debtor in respect of any of the Obligations or the obligations of any person under any security or guarantee held in relation to the same; and
 - (d) any variation of the terms of any of the Obligations or of any security or guarantee (including under this Deed) held in relation to the same; and
 - (e) any failure to realise or fully realise the value of, or any release, discharge, exchange, or substitution of, any security or guarantee held in relation to any of the Obligations; and
 - (f) any failure (whether intentional or not) to take, fully take or perfect any security now or in the future agreed to be taken by the Beneficiary in relation to any of the Obligations; and
 - (g) any other act, event or omission that, but for this clause 2.2, would or might operate or discharge, impair, or otherwise affect any of the obligations of the Guarantor under this Deed or any of the rights, powers, or remedies conferred upon the Beneficiary by the rules or by law.
- 2.3 If any payment to the Beneficiary under this Deed is avoided by law, the Guarantor's obligation to make the payment will not be affected, discharged, or diminished, and the Guarantor must on demand indemnify the Beneficiary against all costs sustained or incurred by the Beneficiary as a result of it being required for any reason to refund all or part of any amount received or recovered by it in respect of such payment and must in

any event pay to the Beneficiary on demand the amount so refunded by it. The Beneficiary and the Guarantor will, in any such case, be deemed to be restored to the position in which each would have been and will be entitled to exercise the rights they respectively would have had if that payment had not been made.

- 2.4 After a demand has been made by the Beneficiary under this Deed, and so long as the Guarantor is under any actual or contingent liability under this Deed, the Guarantor must not—
- (a) exercise in respect of any amount paid by the Guarantor under this Deed any right of subrogation or any other right or remedy that the Guarantor may have in respect of such amount paid; or
 - (b) except with the Beneficiary's consent in writing, claim or receive payment of any other moneys for the time being due to the Guarantor by the Debtor or exercise any other right or remedy that the Guarantor may have in respect of the same; or
 - (c) unless so required by the Beneficiary, prove in the liquidation of the Debtor in competition with the Beneficiary for any moneys owing to the Guarantor by the Debtor on any account.

Any moneys obtained by the Guarantor from the Debtor with such consent or as so required or in breach of this clause must, in each case, be held by the Guarantor upon trust to pay such moneys to the Beneficiary in or towards discharge of the Guarantor's obligations under this Deed.

- 2.5 Any moneys received by the Beneficiary that may be applied in or towards discharge of any of the obligations of the Guarantor under this Deed must be regarded as a payment in gross so that, in the event of the liquidation of the Guarantor, the Beneficiary may prove in the liquidation for the whole of such moneys.

3. **Representations and warranties**

The Guarantor represents that—

- (a) it is duly incorporated and validly existing under the laws of the jurisdiction in which it was incorporated, capable of suing and being sued and has the power to enter into and perform this Deed, and has taken all necessary corporate action to authorise it to enter into, execute, deliver, and perform its obligations under this Deed; and
- (b) its entry into, execution, delivery, and performance of this Deed will not contravene any law or regulation to which the Guarantor is subject or any provision of its constitutional documents and all things (including the obtaining of consents) requisite for such entry, execution, delivery, and performance have been taken, fulfilled, and done, and are in full force and effect; and
- (c) no obligation of the Guarantor under this Deed is secured by, and the execution, delivery and performance of this Deed will not result in the existence of, or oblige it to create, any mortgage, charge, pledge, lien or other encumbrance over any of its present or future revenues or assets; and
- (d) the execution, delivery of and performance of the Guarantor's obligations under this Deed will not cause the Guarantor to be in breach of or in default under any agreement binding on the Guarantor or any of its assets and no material litigation

or administrative proceeding before any court or governmental authority is pending or (so far as the Guarantor knows) threatened against the Guarantor or any of its assets which, if decided against the Guarantor, would have a material adverse effect on the ability of the Guarantor to meet any or all of the obligations in this Deed.

4. **Payments**

All payments to be made by the Guarantor to the Beneficiary under this Deed must be made without set-off or counterclaim and without any deduction or withholding. If the Guarantor is obliged by law to make any deduction or withholding from any such payment, the amount due from the Guarantor in respect of such payment will be increased to the extent necessary to ensure that, after the making of such deduction or withholding, the Beneficiary receives a net amount equal to the amount the Beneficiary would have received had no such deduction or withholding been required to be made.

5. **Continuing security**

This Deed will be a continuing security to the Beneficiary in respect of each Obligation and must not be (or be construed so as to be) discharged by any intermediate discharge or payment of or on account of the Obligations or any settlement of accounts between the Beneficiary and the Debtor or anyone else.

6. **Cancellation**

[Despite anything else in this Deed, the Guarantor may at any time pay to the Beneficiary the Maximum Amount less any amount or amounts the Guarantor may previously have paid under this Deed or such lesser sum as the Beneficiary may require. Upon payment of that sum, this Guarantee shall be cancelled and the Guarantor shall have no further liability.]

[Note: Guarantor to elect either this clause or the following clause as a method of cancellation.]

[The Guarantor may cancel this Deed by giving 90 days' notice in writing to the Beneficiary. Following cancellation of this Guarantee, the Guarantor remains liable for any Obligations incurred before the effective date of cancellation but shall not be liable for any Obligations incurred after that date.]

7. **Assignment**

This Deed may be assigned by the Beneficiary without the Guarantor's consent. It will bind the successors and assigns of the Guarantor.

8. **Notices**

- 8.1 Any demand made on the Guarantor by the Beneficiary under this Deed must be in writing and delivered to the registered office of the Guarantor or to any other address in New Zealand from time to time notified by the Guarantor to the Beneficiary in writing.
- 8.2 The Guarantor must immediately notify the Beneficiary of any change in the above address.

9. **Costs and expenses**

The Guarantor indemnifies the Beneficiary for all costs and expenses (including legal fees and any taxes or duties) incurred by the Beneficiary in the enforcement and protection of its rights under this Deed.

10. Governing law

This Deed is governed by New Zealand law, and the Guarantor irrevocably submits to the non-exclusive jurisdiction of the courts of New Zealand.

[insert execution block for Guarantor]

Schedule 14A.3: replaced, on 1 November 2018, by clause 111 of the Electricity Industry Participation Code Amendment (Code Review Programme) 2018.

Schedule 14A.4 Letter of credit

Schedule 14A.1, cl 3

To: [Clearing manager] (the "Clearing Manager")
(to be advised through [Bank], SWIFT: [Code])
[address]

Attention: [name]

Dear Sir/Madam

IRREVOCABLE TRANSFERABLE STANDBY LETTER OF CREDIT NO. [number]
DATED [date]

We, [Bank] (the "Bank") issue in favour of the Clearing Manager this irrevocable transferable standby letter of credit (the "Letter of Credit") as follows:

The Account Party: [Participant] (the "Account Party")

Beneficiary: The Clearing Manager (the "Beneficiary")

Issued in Connection With: Each obligation of the Account Party to pay the amounts it, now or at any time, owes to, and is invoiced by, the Beneficiary (whether as principal or agent) together with default interest, if any, in relation to such amounts (the "Obligations") under the Electricity Industry Participation Code 2010 (the "Code").

Maximum Amount: \$[insert amount] (the "Maximum Amount").

Expiry: This Letter of Credit expires on the earliest of—

- (a) the date at which the Account Party has ceased to be bound by the Code and has discharged its obligations to the Beneficiary under the Code; or
- (b) the date of satisfaction of this Letter of Credit in accordance with its terms; or
- (c) [the date on which the Bank makes payment to the Beneficiary of the Maximum Amount either at its sole discretion or following demand by the Beneficiary under this Letter of Credit in accordance with its terms,]

[Note: Bank to elect either this clause or the following clause as a method of cancellation.]

- (c) [90 days after notice in writing of cancellation of this Letter of Credit has been given by the Bank to the Clearing Manager, provided that the Bank remains liable for any Obligations incurred before the effective date of cancellation but shall not be liable for any Obligations incurred after that date,](the "Expiry Date").

Payable at: [Sight or by demand using SWIFT]

Available at: [address]

By demand on: The Bank.

Enfaced: Drawn under [Bank] Irrevocable Transferable Standby Letter of Credit No. [number] dated [date].

Returnable to: The Bank upon expiry.

The proceeds of this Letter of Credit are transferable by the Beneficiary. A claim may be made under this Letter of Credit by delivering to the address at which this Letter of Credit is expressed to be available, by no later than [time] New Zealand time on or before the Expiry Date, a draft drawn on the Bank (enfaced as specified above) accompanied by—

- (a) this Letter of Credit; and
- (b) a certificate signed by an authorised signatory of the Beneficiary in the following form:

To [Bank] [date]

[Clearing manager] of [address] (the "Beneficiary") hereby makes claim under the [Bank] Irrevocable Transferable Standby Letter of Credit No. [number] (the "Letter of Credit"). Words and expressions defined in the Letter of Credit will have the same meaning in this Certificate.

[Participant] (the "Account Party") has failed, in whole or in part, to fulfil the Obligations.

As at the date of this Certificate, the amount owed to the Beneficiary by the Account Party in respect of the Obligations is the sum of \$[amount outstanding].

Accordingly, the Beneficiary is entitled to claim and requests payment by [date] of the amount of \$[amount claimed] to be credited to:

Bank: [Beneficiary's bank]

Account number [Beneficiary's trust account number]

Bank's SWIFT Code [Bank's SWIFT Code]

The signatory or signatories is/are authorised by the Beneficiary to make the statements in this Certificate on behalf of the Beneficiary.

Signed.....

Authorised Signatory

This Letter of Credit is subject to the Uniform Customs and Practice for Documentary Credits (2007 Revision) International Chamber of Commerce Publication No. 600 [and the Supplement to the Uniform Customs and Practice for Documentary Credits for Electronic Presentation 2007], except as otherwise provided in this Letter of Credit. Subject to that, this Letter of Credit will be governed by New Zealand law, and the parties irrevocably submit to the non-exclusive jurisdiction of the courts of New Zealand.

The Bank agrees with the Beneficiary that drafts drawn under, and in compliance with, this Letter of Credit and up to the Maximum Amount will be paid on presentation in the manner provided in this Letter of Credit.

[insert execution clause for Bank]

Schedule 14A.4: replaced, on 1 November 2018, by clause 112 of the Electricity Industry Participation Code Amendment (Code Review Programme) 2018.

Schedule 14A.5 Surety bond

Schedule 14A.1, cl 4

To: [Clearing manager] (the "Clearing Manager")
[address]

From: [Surety] (the "Surety")
[address]

Bond Number: [number]

1. [Participant] (the "Principal") has obligations under the Electricity Industry Participation Code 2010 (the "Code") to pay the Clearing Manager amounts invoiced to the Principal by the Clearing Manager ("Obligations").
2. On written demand by the Clearing Manager, the Surety agrees to pay to the Clearing Manager any outstanding amounts invoiced to the Principal, together with any default interest payable in respect of those invoiced amounts. Such written demand must be delivered to the Surety at its above address and certify that the Principal has failed, in whole or in part, to fulfil the Obligations.
3. The Surety's total liability under this Bond shall not exceed \$[insert maximum amount] ("Maximum Amount").
4. [The Surety may at any time pay to the Clearing Manager the Maximum Amount less any amount or amounts the Surety may previously have paid under this Bond or such lesser sum as the Clearing Manager may require. Upon payment of that sum, this Bond will be cancelled and the Surety shall have no further liability.]

[Note: Surety to elect either this proviso or the following proviso as a method of cancellation.]

4. [The Surety may cancel this Bond by giving 90 days' written notice to the Clearing Manager. Following cancellation of this Bond, the Surety remains liable for any Obligations incurred before the effective date of cancellation but shall not be liable for any Obligations incurred after that date.]
5. This Bond is not affected, discharged, or diminished by any act or omission that would, but for this provision, have released a surety but would not have affected, discharged, or diminished the Surety's liability had it been a principal debtor.
6. This Bond may be transferred or assigned by the Clearing Manager without the Surety's consent.
7. Upon cancellation, the Bond will be returned to the Surety.
8. This Bond is governed by New Zealand law, and the Surety agrees to submit to the non-exclusive jurisdiction of the courts of New Zealand.

[insert execution clause for Surety]

Electricity Industry Participation Code 2010
Schedule 14A.5

Schedule 14A.5: amended, on 24 March 2015, by clause 26 of the Electricity Industry Participation Code Amendment (Settlement and Prudential Security) 2014.

Schedule 14A.5: replaced, on 1 November 2018, by clause 113 of the Electricity Industry Participation Code Amendment (Code Review Programme) 2018.

Electricity Industry Participation Code 2010

Part 15 Reconciliation

Contents

- 15.1 Contents of this Part
- 15.2 Requirement to provide complete and accurate information
- 15.3 Provision of trading information at point of connection to network
 - Provision of information to the reconciliation manager*
- 15.4 Submission information to be delivered for reconciliation
- 15.5 Preparing and submitting submission information
- 15.5A Dispatchable load purchaser must prepare dispatchable load information
- 15.5B Deriving volume information if metering installation is within premises that are connected to a point of connection
- 15.5C Aggregating and rounding dispatchable load information
- 15.5D Dispatchable load information to be delivered to reconciliation manager
 - Additional retailer and direct purchaser information*
- 15.6 Retailer and direct purchaser ICP days information
- 15.7 Retailer electricity supplied information
- 15.8 Retailer and direct purchaser half hourly metered ICPs monthly kWh information
 - NSP information*
- 15.9 Grid owner volume information
- 15.10 Participants to provide NSP submission information
- 15.11 Grid connected generator
- 15.12 Accuracy of submitted information
- 15.13 Notice by embedded generators
- 15.14 Notice of changes to the grid
 - Notice of outage constraints or alternative supply*
- 15.15 Notice of points of connection subject to outages or alternative supply
- 15.16 Balancing area NSP grouping changes
- 15.17 Submission information to be reviewed in the case of an outage constraint
- 15.18 Reconciliation manager may request additional information
- 15.19 Seasonal adjustment and profiling
- 15.20 Calculation and allocation of unaccounted for electricity
 - Reconciliation manager processes dispatchable load information and provides it to the clearing manager*
- 15.20A Reconciliation manager to update revised dispatchable load information
- 15.20B Reconciliation manager loss adjusts and summarises dispatchable load information
- 15.20C Reconciliation manager to provide loss adjusted and summarised dispatchable load information to clearing manager
- 15.20D Reconciliation manager to provide loss adjusted and summarised dispatchable load information to dispatchable load purchasers
 - Reconciliation information produced by reconciliation manager*
- 15.21 Providing information specific to reconciliation participants
- 15.22 Providing information to reconciliation participants
- 15.23 Reconciliation information is not final
- 15.24 Reconciliation information checked

- 15.25 Reconciliation manager must assess information not supplied
15.26 Reconciliation manager to correct information
Revisions
15.27 Reconciliation manager must reconcile revised information
15.28 Transitional provisions concerning revisions
15.29 Volume information disputes
Reporting obligations of the reconciliation manager
15.30 *[Revoked]*
15.31 Right to information concerning reconciliation manager's actions
15.32 Reconciliation reports
15.33 *[Revoked]*
15.34 Use of agents by reconciliation participants
15.35 Provision of information
15.36 New Zealand Daylight Time adjustment techniques
15.37 *[Revoked]*
15.37A Reconciliation participants to arrange for regular audits
15.37B Retailers to arrange for audits in respect of distributed unmetered load
15.37C Authority and participant requested audits
Certification
15.38 Functions requiring certification
Participant identifiers
15.39 Participants must use participant identifiers

Schedule 15.1

Certification process

Schedule 15.2

Collection of volume information

Meter interrogation for non half hour metering

Validation

Schedule 15.3

Calculation and provision of submission information

Creation of submission information

Schedule 15.4

Reconciliation procedures

Convert non half hour quantities using profiles

Schedule 15.5

Profile administration

New NSP derived profiles

New statistically sampled/engineered profiles

Appendix 1: Profile classes

Participants NSP-derived profiles

Statistically sampled and engineering profile classes

Appendix 2: Determining statistically sampled profiles

15.1 Contents of this Part

This Part provides for the following:

- (a) the improvement of information about **electricity** conveyed as more **volume information** becomes available over time;
- (b) the correction of information to remedy errors in information provided;
- (c) how **reconciliation participants** must gather, store and provide information about **electricity** conveyed;
- (d) how **reconciliation participants** must prepare and provide **submission information**;
- (da) how **dispatchable load purchasers** must collect **volume information** in accordance with Schedule 15.2;
- (e) how the **reconciliation manager** must calculate responsibility for **electricity** among **reconciliation participants**;
- (f) how the **reconciliation manager** must pass information to the **clearing manager**, for the calculation of amounts owing under Part 14;
- (g) obligations of the **reconciliation manager** to pass the information to **reconciliation participants**, the **registry manager** and the **Authority**;
- (h) requirements for the creation, approval and maintenance of **profiles**;
- (i) requirements for **audits**, approvals and **certifications**.

Compare: Electricity Governance Rules 2003 rule 1 part J

Clause 15.1(da): inserted, on 15 May 2014, by clause 95 of the Electricity Industry Participation (Modified Dispatchable Demand) Code Amendment 2013.

Clause 15.1(f): amended, on 24 March 2015, by clause 21 of the Electricity Industry Participation (Settlement and Prudential Security) Code Amendment 2013.

Clause 15.1(g): amended, on 5 October 2017, by clause 512 of the Electricity Industry Participation Code Amendment (Code Review Programme) 2017.

Clause 15.1(i): amended, on 1 June 2017, by clause 23 of the Electricity Industry Participation Code Amendment (Requirements and Processes for Audits) 2016.

15.2 Requirement to provide complete and accurate information

- (1) A **participant** must take all practicable steps to ensure that information that the **participant** is required to provide to any person under this Part is—
 - (a) complete and accurate; and
 - (b) not misleading or deceptive; and
 - (c) not likely to mislead or deceive.
- (2) If a **participant** becomes aware that the information the **participant** provided under this Part does not comply with subclause (1)(a) to (c), even if the **participant** has taken all practicable steps to ensure that the information complies, the **participant** must, as soon as practicable, provide such further information as is necessary to ensure that the information complies with subclause (1)(a) to (c).

Compare: Electricity Governance Rules 2003 rule 1A part J

Clause 15.2(2): substituted, on 19 December 2014, by clause 39 of the Electricity Industry Participation Code Amendment (Minor Code Amendments) (No 3) 2014.

15.3 Provision of trading information at point of connection to network

- (1) Unless a notice under clause 15.13 is in force, a **trader** must give the **reconciliation manager** a notice that complies with this clause at least **5 business days** before the **trader**—

- (a) commences trading **electricity** at a **point of connection** using a **profile** with a **profile** code other than HHR or RPS or UML or EG1 or PV1; or
 - (b) ceases trading **electricity** at a **point of connection** using a **profile** with a **profile** code other than HHR or RPS or UML or EG1 or PV1.
- (2) A person giving a notice must ensure that the notice complies with any procedures or other requirements specified by the **reconciliation manager**.
 - (3) The **reconciliation manager** must give a copy of every notice to the **clearing manager** and **system operator** no later than 1 **business day** after receiving the notice.

Compare: Electricity Governance Rules 2003 rule 3 part J

Clause 15.3: amended, on 5 October 2017, by clause 513 of the Electricity Industry Participation Code Amendment (Code Review Programme) 2017.

Provision of information to the reconciliation manager

15.4 Submission information to be delivered for reconciliation

- (1) Each **participant** must, by 1600 hours on the 4th **business day** of each **reconciliation period**, ensure that **submission information** has been delivered to the **reconciliation manager** for all **NSPs** for which the **participant** is recorded in the **registry** as having traded **electricity** during the **consumption period** immediately before that **reconciliation period**, in accordance with Schedule 15.3.
- (2) Each **participant** must, by 1600 hours on the 13th **business day** of each **reconciliation period**, ensure that **submission information** has been delivered to the **reconciliation manager** for all **points of connection** for which the **participant** is recorded in the **registry** as having traded **electricity** during any **consumption period** being reconciled in accordance with clauses 15.27 and 15.28, and in respect of which the **participant** has obtained revised **submission information**, in accordance with Schedule 15.3.

Compare: Electricity Governance Rules 2003 rules 4.1.1 and 4.1.2 part J

Clause 15.4(1): amended, on 1 November 2018, by clause 114 of the Electricity Industry Participation Code Amendment (Code Review Programme) 2018.

Clause 15.4(1): amended, on 1 March 2024, by clause 109(1) of the Electricity Industry Participation Code Amendment (Code Review Programme) 2024.

Clause 15.4(2): amended, on 1 March 2024, by clause 109(2) of the Electricity Industry Participation Code Amendment (Code Review Programme) 2024.

15.5 Preparing and submitting submission information

- (1) In preparing and submitting **submission information**, a **participant** must ensure that **volume information** for each **ICP** is allocated to the **NSP** indicated by the data in the **registry** for the relevant **consumption period** at the time the **participant** assembles the **submission information**.
- (2) In preparing and submitting **submission information**, a **participant** must derive **volume information** in accordance with Schedule 15.2.
- (3) If a notice under clause 15.13 is in force for an **embedded generating station** in relation to a **point of connection**, a **participant** that trades at the **point of connection** is not required to comply with clause 15.4 or this clause in relation to **electricity** generated by the **embedded generating station** to which the notice relates.

Compare: Electricity Governance Rules 2003 rules 4.1.3 and 4.1.4 part J

Clause 15.5(1) and (3): amended, on 5 October 2017, by clause 514(a) and (b) of the Electricity Industry Participation Code Amendment (Code Review Programme) 2017.

Clause 15.5(2): substituted, on 15 May 2014, by clause 96 of the Electricity Industry Participation (Modified Dispatchable Demand) Code Amendment 2013.

Clause 15.5(3): amended, on 21 September 2012, by clause 37 of the Electricity Industry Participation (Minor Amendments) Code Amendment 2012.

Clause 15.5(1) to (3): amended, on 1 March 2024, by clause 110 of the Electricity Industry Participation Code Amendment (Code Review Programme) 2024.

15.5A Dispatchable load purchaser must prepare dispatchable load information

- (1) Each **dispatchable load purchaser** must prepare **dispatchable load information** using **volume information** prepared in accordance with Schedule 15.2.
- (2) If clause 15.5B applies to a **dispatch-capable load station's metering installation**, the **dispatchable load purchaser** responsible for the **dispatch-capable load station** must comply with clause 15.5B in relation to the **dispatch-capable load station**.

Clause 15.5A: inserted, on 15 May 2014, by clause 97 of the Electricity Industry Participation (Modified Dispatchable Demand) Code Amendment 2013.

Clause 15.5A(1): amended, on 1 February 2016, by clause 94(1) of the Electricity Industry Participation Code Amendment (Code Review Programme) 2015.

Clause 15.5A(2): substituted, on 1 February 2016, by clause 94(2) of the Electricity Industry Participation Code Amendment (Code Review Programme) 2015.

15.5B Deriving volume information if metering installation is within premises that are connected to a point of connection

- (1) This clause applies if a **dispatch-capable load station's metering installation** is not at a **point of connection** but is located within premises that are directly connected to a **point of connection**.
- (2) If this clause applies, the **dispatchable load purchaser** responsible for the **dispatch-capable load station** must prepare **dispatchable load information** using **volume information** prepared in accordance with Schedule 15.2 and derived from the **raw meter data**—
 - (a) obtained from the **metering installation**; and
 - (b) that the **dispatchable load purchaser** has adjusted, using an accurate **compensation factor**, to compensate for internal site **losses** between the **metering installation** and—
 - (i) if the premises are directly connected to a **point of connection** to the **grid**, the **point of connection** to the **grid**; or
 - (ii) if the premises are directly connected to a **point of connection** to a **local network**, the **point of connection** to the **local network**; or
 - (iii) if the premises are directly connected to a **point of connection** to an **embedded network**, the **point of connection** to the **embedded network**.
- (3) For the purpose of this clause, a **dispatchable load purchaser** must have a **certified metering installation** for each of its **dispatch-capable load stations**.

Clause 15.5B: inserted, on 15 May 2014, by clause 97 of the Electricity Industry Participation (Modified Dispatchable Demand) Code Amendment 2013.

Clause 15.5B: amended, on 23 February 2015, by clause 75 of the Electricity Industry Participation Code Amendment (Distributed Generation) 2014.

Clause 15.5B(1) and (2)(b): amended, on 5 October 2017, by clause 515 of the Electricity Industry Participation Code Amendment (Code Review Programme) 2017.

Clause 15.5B(2): amended, on 1 February 2016, by clause 95(a) and (b) of the Electricity Industry Participation Code Amendment (Code Review Programme) 2015.

15.5C Aggregating and rounding dispatchable load information

- (1) When preparing **dispatchable load information**, a **dispatchable load purchaser** must—
 - (a) aggregate **volume information** to the following level:
 - (i) **NSP code**;
 - (ii) **dispatch-capable load station identifier**;
 - (iii) **loss category code**;
 - (iv) **trading period**; and
 - (b) round the aggregated **volume information**—
 - (i) to 2 decimal places; and
 - (ii) so that if the digit to the right of the second decimal place is—
 - (A) greater than or equal to 5, the second digit is rounded up; or
 - (B) less than 5, the second digit is unchanged.
- (2) When aggregating **volume information** for a **dispatch-capable load station** to the **NSP**, the **dispatchable load purchaser** must use the **NSP code** as shown in the **registry** at the time the **volume information** is derived.

Clause 15.5C: inserted, on 15 May 2014, by clause 97 of the Electricity Industry Participation (Modified Dispatchable Demand) Code Amendment 2013.

Clause 15.5C(2): amended, on 5 October 2017, by clause 516 of the Electricity Industry Participation Code Amendment (Code Review Programme) 2017.

15.5D Dispatchable load information to be delivered to reconciliation manager

- (1) Each **dispatchable load purchaser** must provide to the **reconciliation manager**—
 - (a) **dispatchable load information** for each **GXP** at which the **dispatchable load purchaser** has purchased electricity for a **dispatch-capable load station** during the **consumption period** immediately before each **reconciliation period**; and
 - (b) if the **dispatchable load purchaser** knows that **dispatchable load information** previously provided has changed, revised **dispatchable load information** for the **consumption period** for which the **dispatchable load information** was initially provided.
- (2) Each **dispatchable load purchaser** must provide—
 - (a) the information described in subclause (1)(a) by 1600 hours on the 4th **business day** of each **reconciliation period**; and
 - (b) the information described in subclause (1)(b) by 1600 hours on the 13th **business day** of each **reconciliation period**.

Clause 15.5D: inserted, on 15 May 2014, by clause 97 of the Electricity Industry Participation (Modified Dispatchable Demand) Code Amendment 2013.

Additional retailer and direct purchaser information

15.6 Retailer and direct purchaser ICP days information

- (1) Each **retailer** and **direct purchaser** (excluding **direct consumers**) must deliver a report to the **reconciliation manager** detailing the number of **ICP days** for each **NSP** for each submission file of **submission information** in respect of—
 - (a) **submission information** for the immediately preceding **consumption period**, by 1600 hours on the 4th **business day** of each **reconciliation period**; and
 - (b) revised **submission information** provided in accordance with clause 15.4(2), by 1600 hours on the 13th **business day** of each **reconciliation period**.

- (2) The **retailer** or **direct purchaser** must calculate the **ICP days** information in subclause (1) using the data contained in the **retailer's** or **direct purchaser's** reconciliation system when it aggregates **volume information** for **ICPs** into **submission information**.

Compare: Electricity Governance Rules 2003 rule 4.2.1 part J

15.7 Retailer electricity supplied information

Each **retailer** must deliver to the **reconciliation manager** the **retailer's** total monthly quantity of **electricity supplied** for each **NSP**, aggregated by invoice month, for which the **retailer** has provided **submission information** to the **reconciliation manager**, including revised **submission information** for that period as non **loss** adjusted values in respect of—

- (a) **submission information** for the immediately preceding **consumption period**, by 1600 hours on the 4th **business day** of each **reconciliation period**; and
- (b) revised **submission information** provided in accordance with clause 15.4(2), by 1600 hours on the 13th **business day** of each **reconciliation period**.

Compare: Electricity Governance Rules 2003 rule 4.2.2 part J

15.8 Retailer and direct purchaser half hourly metered ICPs monthly kWh information

Using relevant **volume information**, each **retailer** and **direct purchaser** (excluding **direct consumers**) must deliver to the **reconciliation manager** the total monthly quantity of **electricity** consumed at each **half hourly metered ICP** for which the **retailer** or **direct purchaser** has provided **submission information** to the **reconciliation manager**, including—

- (a) **submission information** for the immediately preceding **consumption period**, by 1600 hours on the 4th **business day** of each **reconciliation period**; and
- (b) revised **submission information** provided in accordance with clause 15.4(2), by 1600 hours on the 13th **business day** of each **reconciliation period**.

Compare: Electricity Governance Rules 2003 rule 4.2.3 part J

Clause 15.8: amended, on 31 December 2021, by clause 65 of the Electricity Industry Participation Code Amendment (Code Review Programme) 2019.

NSP information

15.9 Grid owner volume information

Each **grid owner** must deliver to the **reconciliation manager**, for each **point of connection** for all of its **GXPs**, the following:

- (a) **submission information** for the immediately preceding **consumption period**, by 1600 hours on the 4th **business day** of each **reconciliation period**;
- (b) revised **submission information** provided in accordance with clause 15.4(2), by 1600 hours on the 13th **business day** of each **reconciliation period**.

Compare: Electricity Governance Rules 2003 rule 4.3.1 part J

15.10 Participants to provide NSP submission information

A **participant** must provide the following information to the **reconciliation manager**

for each **NSP** for which the **participant** has given a notice under clause 25(1) of Schedule 11.1:

- (a) **submission information** for the immediately preceding **consumption period**, by 1600 hours on the 4th **business day** of each **reconciliation period**; and
- (b) revised **submission information** provided in accordance with clause 15.4(2), by 1600 hours on the 13th **business day** of each **reconciliation period**.

Compare: Electricity Governance Rules 2003 rule 4.3.2 part J

Clause 15.10 heading: substituted, on 19 December 2014, by clause 40 of the Electricity Industry Participation Code Amendment (Minor Code Amendments) (No 3) 2014.

Clause 15.10: amended, on 15 May 2014, by clause 58 of the Electricity Industry Participation (Minor Code Amendments) Code Amendment 2014.

Clause 15.10: amended, on 5 October 2017, by clause 517 of the Electricity Industry Participation Code Amendment (Code Review Programme) 2017.

15.11 Grid connected generator

Each **generator** who has a **generating station** or **generating unit** with a **point of connection** to the **grid** must deliver to the **reconciliation manager** for each of its **points of connection**—

- (a) **submission information** for the immediately preceding **consumption period**, by 1600 hours on the 4th **business day** of each **reconciliation period**; and
- (b) revised **submission information** provided in accordance with clause 15.4(2), by 1600 hours on the 13th **business day** of each **reconciliation period**.

Compare: Electricity Governance Rules 2003 rule 4.3.3 part J

15.12 Accuracy of submitted information

If a **reconciliation participant** submits information in accordance with this Code, and the **reconciliation participant** subsequently obtains more accurate information, the **reconciliation participant** must provide the most accurate information to the **reconciliation manager** or **participant**, as the case may be, at the next available opportunity for submission in accordance with clauses 15.20A, 15.27 and 15.28.

Compare: Electricity Governance Rules 2003 rule 4.4 part J

Clause 15.12: amended, on 15 May 2014, by clause 98 of the Electricity Industry Participation (Modified Dispatchable Demand) Code Amendment 2013.

15.13 Notice by embedded generators

An **embedded generator** must give a notice to the **reconciliation manager** for an **embedded generating station** in relation to a **point of connection** for the purposes of clauses 15.3 and 15.5(3) if the **embedded generator** will not receive payment from the **clearing manager** or any other person for any **electricity** generated by the relevant **embedded generation station** through the **point of connection** to which the notice relates.

Compare: Electricity Governance Rules 2003 rule 4A part J

Clause 15.13 Heading: amended, on 5 October 2017, by clause 518(1) of the Electricity Industry Participation Code Amendment (Code Review Programme) 2017.

Clause 15.13: amended, on 5 October 2017, by clause 518(2) of the Electricity Industry Participation Code Amendment (Code Review Programme) 2017.

15.14 Notice of changes to the grid

- (1) Each **grid owner** must give written notice to the **reconciliation manager**, in accordance with any procedures or other requirements reasonably specified by the **reconciliation manager** from time to time, of any changes that the **grid owner** intends to make to the **grid** that will affect reconciliation.
- (2) The **grid owner** must give the notice at least 1 month before the effective date of the intended change.
- (3) No later than 1 **business day** after receipt of the notice, the **reconciliation manager** must give a copy of the notice to the **clearing manager** and the **Authority**.
- (4) Each **grid owner** must give notice of an intended change to an existing **point of connection** to the **grid** or a new **point of connection** to the **grid** to be **commissioned**.

Compare: Electricity Governance Rules 2003 rule 5 part J

Clause 15.14 Heading: amended, on 5 October 2017, by clause 519(1) of the Electricity Industry Participation Code Amendment (Code Review Programme) 2017.

Clause 15.14: amended, on 5 October 2017, by clause 519(2) of the Electricity Industry Participation Code Amendment (Code Review Programme) 2017.

Clause 15.14(3): amended, on 19 January 2017, by clause 16 of the Electricity Industry Participation Code Amendment (Extended Reserve) 2016.

Clause 15.14(3): amended, on 21 December 2021, by clause 42 of the Electricity Industry Participation Code Amendment (Automatic Under-Frequency Load Shedding Systems) 2021.

Notice of outage constraints or alternative supply

Cross Heading: amended, on 5 October 2017, by clause 520 of the Electricity Industry Participation Code Amendment (Code Review Programme) 2017.

15.15 Notice of points of connection subject to outages or alternative supply

No later than 2 hours after **publication** of **final prices** for all **trading periods** in a **consumption period**,—

- (a) the **WITS manager** must give written notice to the **reconciliation manager** of the following:
 - (i) each **point of connection** to the **grid** that had no load or generation connected to it in the **system operator's** modelling system in the **consumption period**:
 - (ii) in relation to each **point of connection** referred to in subparagraph (i), the **trading periods** in the **consumption period** during which the **point of connection** to the **grid** had no load or generation connected to it in the **system operator's** modelling system

(b) *[Revoked]*

Compare: Electricity Governance Rules 2003 rule 6.1 part J

Clause 15.15 Heading: amended, on 5 October 2017, by clause 521(1) of the Electricity Industry Participation Code Amendment (Code Review Programme) 2017.

Clause 15.15: substituted, on 13 June 2013, by clause 5 of the Electricity Industry Participation (Information Flows) Code Amendment 2013.

Clause 15.15: amended, on 5 October 2017, by clause 521(2) of the Electricity Industry Participation Code Amendment (Code Review Programme) 2017.

Clause 15.15(a): amended, on 1 November 2022, by clause 192(1) of the Electricity Industry Participation Code Amendment (Real Time Pricing) 2022.

Clause 15.15(a)(i): amended, on 1 November 2022, by clause 192(2) of the Electricity Industry Participation Code Amendment (Real Time Pricing) 2022.

Clause 15.15(a)(ii): amended, on 1 November 2022, by clause 192(3)(a) and (b) of the Electricity Industry Participation Code Amendment (Real Time Pricing) 2022.

Clause 15.15(b): revoked, on 1 November 2022, by clause 192(4) of the Electricity Industry Participation Code Amendment (Real Time Pricing) 2022.

15.16 Balancing area NSP grouping changes

If an **NSP** has been affected by an **outage constraint**, and the **reconciliation manager** has determined the notice it receives in accordance with clause 24 of Schedule 11.1 is not compliant with that clause, the **reconciliation manager** must, no later than 10 **business days** after the date on which it determines the notice is not compliant, effect, in consultation with the relevant **distributor**, any changes that are, in the **reconciliation manager's** opinion, necessary to **balancing area NSP** groupings that are to be used during the **outage constraint**.

Compare: Electricity Governance Rules 2003 rule 6.2 part J

Clause 15.16: amended, on 5 October 2017, by clause 522 of the Electricity Industry Participation Code Amendment (Code Review Programme) 2017.

15.17 Submission information to be reviewed in the case of an outage constraint

In the case of an **outage constraint**, the **reconciliation manager** must—

- (a) review the **submission information** in accordance with a notice received in accordance with clause 15.15 and satisfy itself that the **submission information** is consistent with the occurrence of the stated **outage constraint**; and
- (b) reconcile the **submission information** for the affected **NSP** within the **balancing area** identified in accordance with clause 15.15 for the **trading periods** during which the **outage constraint** applied; and
- (c) as soon as reasonably practicable, but no later than 2 **business days** after **publication** of **final prices**, give written notice to any **reconciliation participants** who were affected by the **outage constraint** affecting the **NSPs**, of the **trading periods** in the prior **consumption period** during which the **outage constraint** applied, and any changes to **balancing area NSP** groupings made in accordance with clause 15.16; and
- (d) if a **reconciliation participant's submission information** has been affected by an **outage constraint** in a **consumption period**, and the **reconciliation participant** disputes or queries, in accordance with clause 15.24, the change to **balancing area NSP** groupings made in accordance with clause 15.16, the **reconciliation manager** must, no later than 10 **business days** after it determines that the notice it receives in accordance with clause 24 of Schedule 11.1 is not compliant, in consultation with the **distributor, generator or purchaser** concerned, assess whether a different **balancing area NSP** grouping would be more appropriate in the circumstances of the particular **outage constraint**. The **reconciliation manager** may change the alternative **balancing area NSP** grouping for the particular **outage constraint** and, if the alternative **balancing area NSP** grouping is changed, the **reconciliation manager** must update the information changed in accordance with clause 15.16 as necessary.

Compare: Electricity Governance Rules 2003 rule 6.3 part J

Clause 15.17(c): amended, on 13 June 2013, by clause 6 of the Electricity Industry Participation (Information Flows) Code Amendment 2013.

Clause 15.17(c) and (d): amended, on 5 October 2017, by clause 523(a) and (b) of the Electricity Industry Participation Code Amendment (Code Review Programme) 2017.

15.18 Reconciliation manager may request additional information

For the purpose of carrying out its role in accordance with this Code, the **reconciliation manager** may, in respect of a **consumption period**, give notice to a **reconciliation participant** that it requires such additional information from the **reconciliation participant** as the **reconciliation manager** reasonably requires, and the **reconciliation participant** must, as soon as practicable, provide such information to the **reconciliation manager**.

Compare: Electricity Governance Rules 2003 rule 7 part J

15.19 Seasonal adjustment and profiling

- (1) The **reconciliation manager** must process **submission information** derived from non **half hour volume information** using a **profile** to allocate the non **half hour submission information** to **trading periods** in accordance with Schedule 15.4.
- (2) **Profiles** must be established and changed (if necessary) in accordance with Schedule 15.5.
- (3) For each reconciliation revision, the **reconciliation manager** must—
 - (a) subject to paragraph (c), recalculate the **seasonal adjustment shape** for each reconciliation revision cycle; and
 - (b) reconcile **submission information** using the latest **profile** shape published, and the most recently supplied **profile** information; and
 - (c) recalculate the residual **profile** shape and any shapes approved as **NSP** derived **profile** shapes under clauses 19 to 24 of Schedule 15.5 for each reconciliation revision cycle and use the shape to allocate non **half hour** data across the **trading periods**, in accordance with Schedule 15.5; and
 - (d) not recalculate the **seasonal adjustment shape** after the month 7 reconciliation revision.
- (4) Subclause (3)(d) does not prevent the **reconciliation manager** from recalculating the **seasonal adjustment shape** following the month 7 reconciliation revision if necessary to resolve a dispute under clauses 14.25 or 15.29, or to correct information under clauses 15.21 to 15.26.

Compare: Electricity Governance Rules 2003 rule 8 part J

Clause 15.19(4): amended, on 21 September 2012, by clause 38 of the Electricity Industry Participation (Minor Amendments) Code Amendment 2012.

Clause 15.19(4): amended, on 24 March 2015, by clause 22 of the Electricity Industry Participation (Settlement and Prudential Security) Code Amendment 2013.

15.20 Calculation and allocation of unaccounted for electricity

The **reconciliation manager** must, in accordance with Schedule 15.4,—

- (a) calculate the **scorecard rating** of each **retailer**; and
- (b) calculate the **unaccounted for electricity**; and
- (c) allocate the **unaccounted for electricity** to, and balance, the total **electricity supplied**, for each **NSP**.

Compare: Electricity Governance Rules 2003 rule 9 part J

Reconciliation manager processes dispatchable load information and provides it to clearing manager

Cross Heading: inserted, on 15 May 2014, by clause 99 of the Electricity Industry Participation (Modified Dispatchable Demand) Code Amendment 2013.

15.20A Reconciliation manager to update revised dispatchable load information

- (1) This clause applies to any revised **dispatchable load information** provided under clause 15.5D(1)(b).
- (2) The **reconciliation manager** must,—
 - (a) if the **dispatchable load information** to which this clause applies relates to 1 or more **consumption periods** being 1, 3, 7, or 14 months before the current **reconciliation period**, conduct a further update for each applicable **consumption period**; or
 - (b) if the **dispatchable load information** to which this clause applies relates to a **consumption period** other than the **consumption periods** set out in paragraph (a),—
 - (i) store the **dispatchable load information** until the **consumption period** becomes 1 of the **consumption periods** set out in paragraph (a); and
 - (ii) conduct a further update under paragraph (a).
- (3) The **reconciliation manager** must not update revised **dispatchable load information** for a **consumption period** if 14 months have elapsed since the end of the **consumption period**.
- (4) Subclause (3) does not prevent the correction of information under clauses 14.28, 15.26(2), or 15.29.

Clauses 15.20A: inserted, on 15 May 2014, by clause 99 of the Electricity Industry Participation (Modified Dispatchable Demand) Code Amendment 2013.

Clause 15.20A(4): amended, on 24 March 2015, by clause 23 of the Electricity Industry Participation (Settlement and Prudential Security) Code Amendment 2013.

15.20B Reconciliation manager loss adjusts and summarises dispatchable load information

- (1) The **reconciliation manager** must apply **loss factors** to **dispatchable load information** received under clause 15.5D—
 - (a) for each **trading period**; and
 - (b) using the **loss category** codes advised by the **dispatchable load purchaser** when submitting **dispatchable load information** under clause 15.5D.
- (2) After applying **loss factors** under subclause (1), the **reconciliation manager** must summarise—
 - (a) into 1 file for each **consumption period, dispatchable load information** received under clause 15.5D(1)(a); and
 - (b) into 1 file for each **consumption period, dispatchable load information** received under clause 15.5D(1)(b) and updated under clause 15.20A.
- (3) The **Authority** may direct the **reconciliation manager** to apply specified values for **loss factors** for each **loss category** for a **reconciliation period** for which the **registry manager** does not provide the **reconciliation manager** with the **loss factors** for each **loss category** in accordance with clause 11.26(b).
- (4) If the **Authority** makes a direction under subclause (3), the **reconciliation manager** must apply the values as **loss factors** to the relevant **dispatchable load information** for all **reconciliation periods** during which the direction applies.

Clause 15.20B: inserted, on 15 May 2014, by clause 99 of the Electricity Industry Participation (Modified Dispatchable Demand) Code Amendment 2013.

Clause 15.20B(3): amended, on 5 October 2017, by clause 524 of the Electricity Industry Participation Code Amendment (Code Review Programme) 2017.

15.20C Reconciliation manager to provide loss adjusted and summarised dispatchable load information to clearing manager

The **reconciliation manager** must provide to the **clearing manager**—

- (a) the information described in clause 15.20B(2)(a) by 1600 hours on the 7th **business day** of each **reconciliation period**; and
- (b) the information described in clause 15.20B(2)(b) by 1200 hours on the last **business day** of each **reconciliation period**.

Clause 15.20C: inserted, on 15 May 2014, by clause 99 of the Electricity Industry Participation (Modified Dispatchable Demand) Code Amendment 2013.

15.20D Reconciliation manager to provide loss adjusted and summarised dispatchable load information to dispatchable load purchasers

At the same time the **reconciliation manager** provides the information described in clause 15.20C to the **clearing manager**, the **reconciliation manager** must provide each **dispatchable load purchaser** with the part of the information that relates to the **dispatchable load purchaser**.

Clause 15.20D: inserted, on 15 May 2014, by clause 99 of the Electricity Industry Participation (Modified Dispatchable Demand) Code Amendment 2013.

Reconciliation information produced by reconciliation manager

15.21 Providing information specific to reconciliation participants

The **reconciliation manager** must provide information specific to each **reconciliation participant** and the **clearing manager** in accordance with Schedule 15.4.

Compare: Electricity Governance Rules 2003 rule 10.1 part J

15.22 Providing information to reconciliation participants

The **reconciliation manager** must provide to a **reconciliation participant** the information it has concerning the quantity of **electricity** conveyed at an **NSP** for each **consumption period**, by a time agreed between the **reconciliation participant** and the **reconciliation manager** (or if no such time can be agreed, by such time as determined by the **Authority**), if—

- (a) the **reconciliation participant** has requested the information; and
- (b) the **reconciliation participant** has purchased or sold **electricity** at the **NSP** during the **consumption period** or, in the case of a **network owner**, has a liability as a transporter of **electricity** in relation to the **NSP**; and
- (c) the **reconciliation participant** meets the **reconciliation manager's** reasonable costs of providing the information; and
- (d) the **reconciliation participant** ensures that all information received in accordance with this clause is kept and maintained confidential to the employees of the **reconciliation participant** who are required to have access to the information to enable the **reconciliation participant** to identify errors in the **reconciliation information** produced for the **NSP**; and

- (e) the **reconciliation participant** ensures that all information received in accordance with this clause is not used for any purpose other than enabling the **reconciliation participant** to identify errors in the **submission information** submitted for the **NSP** or, in the case of any **network** owner, other than for a legitimate purpose directly related to the **network** owner's liability as a transporter of **electricity** in relation to that **NSP**; and
- (f) the **reconciliation participant** implements and maintains best practice internal procedures to meet its obligations in accordance with this clause.

Compare: Electricity Governance Rules 2003 rule 10.2 part J
Clause 15.22(e): amended, on 5 October 2017, by clause 525 of the Electricity Industry Participation Code Amendment (Code Review Programme) 2017.

15.23 Reconciliation information is not final

The **reconciliation information** provided in accordance with clauses 15.21 and 15.22 is subject to assessment in accordance with clauses 15.24 to 15.26.

Compare: Electricity Governance Rules 2003 rule 10.3 part J

15.24 Reconciliation information checked

- (1) The **reconciliation participant** must check the accuracy of the **reconciliation information** provided by the **reconciliation manager** under clauses 15.21 and 15.22.
- (2) The **reconciliation participant** may dispute the **volume information** on which the **reconciliation information** provided by the **reconciliation manager** under clauses 15.21 and 15.22 is based in accordance with clause 15.29.

Compare: Electricity Governance Rules 2003 rules 10.4 and 10.4A part J

15.25 Reconciliation manager must assess information not supplied

- (1) If a **reconciliation participant** fails to provide any information to the **reconciliation manager** that the **reconciliation participant** is required to provide under this Part, the **reconciliation manager** must take all reasonable steps necessary to acquire or estimate the information, and in the case of missing **trader** data the **reconciliation manager** must—
 - (a) estimate a **purchaser's volume information** by applying the **ICP day** scaling factor in accordance with Schedule 15.4; and
 - (b) estimate a **generator's volume information** by using an **estimated reading**.
- (2) Subclause (1) does not apply to information that the **reconciliation manager** is directed by the **Authority** to correct under clause 15.26(2).

Compare: Electricity Governance Rules 2003 rules 10.5 and 10.5A part J

15.26 Reconciliation manager to correct information

- (1) If the **reconciliation manager** has, in accordance with clause 15.25(1), acquired or estimated information, or is unable to provide **reconciliation information**, it must, to the extent it is reasonable, attempt to subsequently establish the correct **reconciliation information**, provide the updated **reconciliation information** to the **clearing manager** and distribute the information to the **reconciliation participants** entitled to it in accordance with this Code.

- (2) If the **reconciliation manager** considers that information provided by a **reconciliation participant** or a **service provider** under this Part is incorrect, the **reconciliation manager** must refer the issue to the **Authority**, and, if directed by the **Authority** to do so, take all reasonable steps to correct the information.
- (3) A **reconciliation participant** or **service provider** must provide any information to the **reconciliation manager** that the **reconciliation manager** requires to correct information under subclause (2).
- (4) If the **reconciliation manager** has corrected information under subclause (2), the **reconciliation manager** must provide the corrected information to the **clearing manager** and the **reconciliation participants** who are entitled to the information under this Code.
- (5) The **reconciliation manager** must not correct information later than 24 months after the date on which information about an amount owing to which the incorrect information relates (if any) has been advised under Part 14.

Compare: Electricity Governance Rules 2003 rules 10.6 to 10.10 part J
Clause 15.26(5): amended, on 24 March 2015, by clause 24 of the Electricity Industry Participation (Settlement and Prudential Security) Code Amendment 2013.

Revisions

15.27 Reconciliation manager must reconcile revised information

- (1) If the **reconciliation manager** receives revised **NSP** information or **submission information** that has been supplied to it since the previous reconciliation calculation in accordance with clauses 15.4(2) or 15.12, the **reconciliation manager** must reconcile the information in accordance with the following procedure:
 - (a) if the **submission information** received relates to 1 or more **consumption periods** being 1, 3, 7, or 14 months before the current **reconciliation period**, a further reconciliation must be conducted for that **consumption period** or those **consumption periods**:
 - (b) if the **NSP** information or **submission information** relates to any other **consumption period**, the **reconciliation manager** must store the information and wait until the **consumption period** becomes 1 of the **consumption periods** described in paragraph (a) before conducting a further reconciliation.
- (2) The **reconciliation manager** must not reconcile revised **NSP** or **submission information** arising after month 14.
- (3) Subclause (2) does not prevent the correction of information under clauses 14.28, 15.26(2) or 15.29.

Compare: Electricity Governance Rules 2003 rules 11.1 to 11.2A part J
Clause 15.27(3): amended, on 24 March 2015, by clause 25 of the Electricity Industry Participation (Settlement and Prudential Security) Code Amendment 2013.

15.28 Transitional provisions concerning revisions

- (1) In this clause—
 - (a) “transitional revisions” means any revision carried out by the **reconciliation manager** in accordance with this clause, for **any reconciliation period** that includes a **trading period** that occurred before 1 May 2008; and

- (b) “incumbent **retailer**” means, for each **balancing area**, the relevant **retailer** to be set out in the list of **NSPs** by **balancing area** and their corresponding **retailers**, **published** from time to time by the **reconciliation manager**, in accordance with subclause (3).
- (2) The intent of this clause is—
- (a) as far as practicable, to preserve the effect of the reconciliation provisions concerning revisions that were in effect immediately before 1 May 2008, for all transitional revisions; and
- (b) to clarify that **volume information** and **submission information** for all transitional revisions (except as provided in this clause) must be submitted by **reconciliation participants** in accordance with this Part; and
- (c) to clarify the application of certain clauses concerning disputes that existed before 1 May 2008.
- (3) The **reconciliation manager** must **publish** a list of the incumbent **retailers** finalised under rule 11.4.3.2 of part J of the **rules** until all transitional revisions are completed.
- (4) Despite anything in this Code—
- (a) to avoid doubt, clause 8 of Schedule 15.3 applies to **submission information** in relation to all transitional revisions; and
- (b) each **reconciliation participant**, including each incumbent **retailer**, must submit the required **submission information** relating to all transitional revisions in accordance with clause 15.4(2); and
- (c) if the **submission information** to be **supplied** for a transitional revision is the first such submission after 1 May 2008, the **reconciliation participant** must provide a full data set as if it were an initial submission in accordance with clause 15.4(1); and
- (d) in recognition of the fact that incumbent **retailers** have not, before 1 May 2008, been required to submit the **submission information** referred to in paragraph (b), the **certification** and **audit** requirements of Schedule 15.1 (required for activities in accordance with clauses 2 to 8 and 11 of Schedule 15.3, and clause 17 of Schedule 15.4), do not apply in relation to the non **half-hour metering information** required to be submitted by incumbent **retailers** to the **reconciliation manager** for transitional revisions.
- (5) Despite anything in this Code, all transitional revisions must be carried out by the **reconciliation manager** in accordance with this Code, subject to the following:
- (a) for the purposes of clause 7 of Schedule 15.4, the **ICP** scaling factor is 1; and
- (b) for the purposes of clauses 18(1)(b) and 19 of Schedule 15.4 the **scorecard rating** (SC_{Ri}) for each **retailer** (other than the incumbent **retailer**) is 1; and
- (c) for the purposes of clause 19 of Schedule 15.4, at each **NSP** the market share proportion (MS_{Ri}) for the incumbent **retailer** is 1, and, for all other **retailers**, is 0.
- (6) Despite anything in this Code, all disputes concerning **metering installations** or **consumption information** in relation to transitional revisions—
- (a) that existed before 1 May 2008 are not affected by the coming into effect of part J of the **rules** and this Part; and

- (b) must be commenced no later than 2 years after the date of issue of any invoice to which the disputed information relates.
- (7) Despite anything in this Code—
 - (a) as soon as practicable after 16 October 2008, the **reconciliation manager** must publish 1 **seasonal adjustment shape** for each **balancing area** that existed at the beginning of the 1st **trading period** of May 2008; and
 - (b) the **reconciliation manager** must not publish any further **seasonal adjustment shapes** for the **consumption periods** for which transitional revisions are required; and
 - (c) no later than 5 **business days** after the date on which those **seasonal adjustment shapes** are published, each **reconciliation participant** must provide **submission information** to the **reconciliation manager** based on those **seasonal adjustment shapes** for the months of February to July 2008; and
 - (d) as soon as practicable after the expiry of the time referred to in paragraph (c) the **reconciliation manager** must complete revisions using that **submission information** for the months of February 2008 to July 2008; and
 - (e) each **reconciliation participant** must continue to use the **seasonal adjustment shapes** published by the **reconciliation manager** under paragraph (a) for all subsequent transitional revisions for the period for which transitional revisions are required.

Compare: Electricity Governance Rules 2003 rule 11.4 part J

15.29 Volume information disputes

- (1) A **reconciliation participant** may commence a dispute relating to **volume information** by notice in writing to the **reconciliation manager**.
- (2) A **reconciliation participant** may not give written notice of a dispute under subclause (1) if information about an amount owing based on the **volume information** has been advised under Part 14.
- (3) The **reconciliation manager** must give written notice to the **Authority** and all **participants** affected by the dispute no later than 1 **business day** after receiving notice of the dispute under subclause (1).
- (4) On receiving a notice of a dispute under subclause (3), the **Authority** may direct that no further action be taken in respect of the dispute.
- (5) If the **Authority** gives a direction under subclause (4), subclauses (6) to (13) cease to apply to the dispute. However, a direction under subclause (4) does not affect the validity of a **washup** conducted under clauses subpart 6 of Part 14 before the direction was given.
- (6) The disputing **reconciliation participant** and the **reconciliation manager** must use reasonable endeavours to resolve the dispute.
- (7) A dispute does not excuse anyone from complying with this Code.
- (8) **Participants** must continue to use disputed **volume information** as if it were not in dispute while the dispute is being resolved.

- (9) If a dispute is not resolved within 15 **business days** after the date on which the **reconciliation manager** received notice of the dispute under subclause (1), the disputing **reconciliation participant** or the **reconciliation manager** may refer the dispute to the **Rulings Panel** for resolution under the **Act**.
- (10) The **Rulings Panel** may make such determination as it thinks fit.
- (11) The **Rulings Panel** must give written notice of its determination to the disputing **reconciliation participant** and affected **participants**.
- (12) If the dispute is resolved by the parties to the dispute agreeing, or the **Rulings Panel** determining, that the **volume information** is incorrect, the **reconciliation manager** must correct the **volume information** as follows:
- (a) if a revised **seasonal adjustment shape** must be issued in order for the **volume information** to be corrected—
- (i) the **reconciliation manager** must provide each **reconciliation participant** whose **submission information** is required to be corrected with a revised **seasonal adjustment shape**; and
- (ii) each **reconciliation participant** must provide corrected **submission information** to the **reconciliation manager** no later than 4 **business days** after being provided with the revised **seasonal adjustment shape**:
- (b) if a revised **seasonal adjustment shape** does not need to be issued in order for the **volume information** to be corrected, each **reconciliation participant** whose **volume information** or **dispatchable load information** is required to be corrected must provide corrected relevant information to the **reconciliation manager** no later than 4 **business days** after receiving notice of the resolution of the dispute.
- (13) The **reconciliation manager** must provide the corrected **volume information** to the **clearing manager**.

(14) *[Revoked]*

Compare: Electricity Governance Rules 2003 rule 12 part J

Clause 15.29(2): amended, on 24 March 2015, by clause 26(a) of the Electricity Industry Participation (Settlement and Prudential Security) Code Amendment 2013.

Clause 15.29(2): amended, on 5 October 2017, by clause 526(a) of the Electricity Industry Participation Code Amendment (Code Review Programme) 2017.

Clause 15.29(3): replaced, on 5 October 2017, by clause 526(b) of the Electricity Industry Participation Code Amendment (Code Review Programme) 2017.

Clause 15.29(4): amended, on 5 October 2017, by clause 526(c) of the Electricity Industry Participation Code Amendment (Code Review Programme) 2017.

Clause 15.29(5): amended, on 24 March 2015, by clause 26(b) of the Electricity Industry Participation (Settlement and Prudential Security) Code Amendment 2013.

Clause 15.29(5): amended, on 24 March 2015, by clause 13(1) of the Electricity Industry Participation Code Amendment (Late and Revised Data) 2015.

Clause 15.29(9): amended, on 5 October 2017, by clause 526(d) of the Electricity Industry Participation Code Amendment (Code Review Programme) 2017.

Clause 15.29(11): amended, on 5 October 2017, by clause 526(e) of the Electricity Industry Participation Code Amendment (Code Review Programme) 2017.

Clause 15.29(12): amended, on 5 October 2017, by clause 526(f) of the Electricity Industry Participation Code Amendment (Code Review Programme) 2017.

Clause 15.29(12)(b): amended, on 15 May 2014, by clause 59 of the Electricity Industry Participation (Minor Code Amendments) Code Amendment 2014.

Clause 15.29(12)(b): amended, on 19 September 2014, by clause 5 of the Electricity Industry Participation Code Amendment (Minor Code Amendments) (No 2) 2014.

Clause 15.29(14): amended, on 24 March 2015, by clause 26(c) of the Electricity Industry Participation (Settlement and Prudential Security) Code Amendment 2013.

Clause 15.29(14): revoked, on 24 March 2015, by clause 13(2) of the Electricity Industry Participation Code Amendment (Late and Revised Data) 2015.

Reporting obligations of the reconciliation manager

15.30 *[Revoked]*

Compare: Electricity Governance Rules 2003 rule 13.1 part J
Clause 15.30: revoked, on 1 November 2018, by clause 115 of the Electricity Industry Participation Code Amendment (Code Review Programme) 2018.

15.31 Right to information concerning reconciliation manager's actions

- (1) A **reconciliation participant** may, by giving written notice to the **reconciliation manager**, request further information related to—
 - (a) any alleged breach of this Code by the **reconciliation manager**;
 - (b) any alleged breach of this Part by a **reconciliation participant**, if the alleged breach has materially affected the **reconciliation participant** requesting the information.
- (2) The **reconciliation manager** must, no later than 10 **business days** after receiving such a request, provide the requested information to the **reconciliation participant**, provided that the information does not include any information that is confidential in respect of any other person.

Compare: Electricity Governance Rules 2003 rule 13.2 part J
Clause 15.31(1): replaced, on 1 November 2018, by clause 116 of the Electricity Industry Participation Code Amendment (Code Review Programme) 2018.

15.32 Reconciliation reports

The **reconciliation manager** must report to the **Authority** and each **reconciliation participant**, the information determined during the reconciliation process as described in clauses 24 to 28 of Schedule 15.4.

Compare: Electricity Governance Rules 2003 rule 13.3 part J

15.33 *[Revoked]*

Compare: Electricity Governance Rules 2003 rule 14 part J
Clause 15.33: amended, on 15 May 2014, by clause 60 of the Electricity Industry Participation (Minor Code Amendments) Code Amendment 2014.
Clause 15.33: amended, on 1 February 2016, by clause 96 of the Electricity Industry Participation Code Amendment (Code Review Programme) 2015.
Clause 15.33: revoked, on 1 November 2018, by clause 117 of the Electricity Industry Participation Code Amendment (Code Review Programme) 2018.

15.34 Use of agents by reconciliation participants

- (1) A **reconciliation participant** who has obligations under this Part may discharge those obligations by way of an agent.
- (2) A **reconciliation participant** who utilises an agent to discharge an obligation under this Code remains responsible and liable for, and is not in any way released from, that obligation.
- (3) A **reconciliation participant** must not assert, against anyone, that it is not responsible or liable for its obligations because the **reconciliation participant's** agent has done or not done something or has failed to meet a relevant standard.

Compare: Electricity Governance Rules 2003 rule 15 part J

15.35 Provision of information

- (1) If an obligation exists to provide information in accordance with this Part, a **participant** must deliver that information to the required person within the timeframe specified in this Code, or, in the absence of any such timeframe, within any timeframe the **Authority** specifies in writing.
- (2) Such information must be delivered in the format determined from time to time by the **Authority**.
- (3) Unless otherwise specified in this Part, information that must be provided under this Part by the **registry manager** or to the **registry manager**, must be provided using the **registry**.

Compare: Electricity Governance Rules 2003 rule 16 part J

Clause 15.35(1): amended, on 5 October 2017, by clause 527(a) of the Electricity Industry Participation Code Amendment (Code Review Programme) 2017.

Clause 15.35(3): inserted, on 5 October 2017, by clause 527(b) of the Electricity Industry Participation Code Amendment (Code Review Programme) 2017.

15.36 New Zealand Daylight Time adjustment techniques

- (1) **Submission information** provided to, and **reconciliation information** provided by, the **reconciliation manager** must, if applicable, be adjusted for **NZDT** using the technique set out in subclause (3).
- (2) Any information exchanged between **participants** that contains **trading period** specific data must, if applicable, be adjusted for **NZDT** in accordance with subclause (3).
- (3) A daylight savings adjustment must be made by using the “**trading period** run on technique”, which requires that daylight saving adjustment periods are allocated as consecutive **trading periods** within the relevant day, in the sequence that they occur.
- (4) If no adjustment is made in accordance with subclause (3) to information exchanged between **reconciliation participants** that contains **trading period** specific data, the code “**NZST**” must be used within the data transfer file.

Compare: Electricity Governance Rules 2003 rule 17 part J

Clause 15.36(3): substituted, on 1 February 2016, by clause 97 of the Electricity Industry Participation Code Amendment (Code Review Programme) 2015.

Clause 15.36(1): amended, on 1 March 2024, by clause 111 of the Electricity Industry Participation Code Amendment (Code Review Programme) 2024.

15.37 *[Revoked]*

Compare: Electricity Governance Rules 2003 rule 18 part J

Clause 15.37(1): substituted, on 1 February 2016, by clause 98(1) of the Electricity Industry Participation Code Amendment (Code Review Programme) 2015.

Clause 15.37(2): revoked, on 1 February 2016, by clause 98(2) of the Electricity Industry Participation Code Amendment (Code Review Programme) 2015.

Clause 15.37: revoked, on 1 June 2017, by clause 24 of the Electricity Industry Participation Code Amendment (Requirements and Processes for Audits) 2016.

15.37A Reconciliation participants to arrange for regular audits

Each **reconciliation participant** with one or more obligations under this Part must arrange to be **audited** regularly under Part 16A in respect of those obligations.

Clause 15.37A: inserted, on 1 June 2017, by clause 25 of the Electricity Industry Participation Code Amendment (Requirements and Processes for Audits) 2016.

Clause 15.37A Heading: amended, on 1 March 2024, by clause 112(1) of the Electricity Industry Participation Code Amendment (Code Review Programme) 2024.

Clause 15.37A: amended, on 1 March 2024, by clause 112(2) of the Electricity Industry Participation Code Amendment (Code Review Programme) 2024.

15.37B Retailers to arrange for audits in respect of distributed unmetered load

Each **retailer** that is responsible for **distributed unmetered load** must arrange for an **audit** to be carried out in accordance with Part 16A in respect of the **distributed unmetered load** that verifies that—

- (a) the **retailer's distributed unmetered load** database complies with clause 11 of Schedule 15.3; and
- (b) the information recorded in the **retailer's distributed unmetered load** database is complete and accurate; and
- (c) **volume information** for the **distributed unmetered load** is being calculated accurately and **profiles** have been correctly applied.

Clause 15.37B: inserted, on 1 June 2017, by clause 25 of the Electricity Industry Participation Code Amendment (Requirements and Processes for Audits) 2016.

15.37C Authority and participant requested audits

- (1) The **Authority** may at any time carry out, or appoint an **auditor** to carry out, an **audit** of a **participant** in respect of the **participant's** obligations under this Part.
- (2) If a **participant** considers that another **participant** may not have complied with this Part, the **participant** may request that the **Authority** carry out, or appoint an **auditor** to carry out, an **audit** of the other **participant**.
- (3) Part 16A applies to an **audit** carried out under this clause.

Clause 15.37C: inserted, on 1 June 2017, by clause 25 of the Electricity Industry Participation Code Amendment (Requirements and Processes for Audits) 2016.

Certification

Cross heading Certification: inserted, on 15 May 2014, by clause 61 of the Electricity Industry Participation (Minor Code Amendments) Code Amendment 2014.

15.38 Functions requiring certification

- (1) Subject to clauses 2A and 2B of Schedule 15.1, a **reconciliation participant** must obtain and maintain **certification** under Schedule 15.1 to be permitted to perform, or to have performed by an agent or agents, any of the following functions under this Code:
 - (a) maintaining **registry** information and performing **ICP** switching (except if the maintenance of **registry** information is carried out by a **distributor** under Part 11):
 - (b) gathering and storing **raw meter data**;
 - (c) creating and managing (including validating, estimating, storing, correcting and archiving)—
 - (i) **half hour volume information**; or
 - (ii) non **half hour volume information**; or
 - (iii) **half hour** and non **half hour volume information**;
 - (iv) *[Revoked]*
 - (d) delivery of:
 - (i) a report under clause 15.6 and the calculation of the number of **ICP days** detailed in the report;
 - (ii) **electricity supplied** information under clause 15.7;
 - (iii) information from **retailer** and **direct purchaser half hourly** metered **ICPs** under clause 15.8;

- (da) *[Revoked]*
- (db) *[Revoked]*
- (e) provision of **submission information** for reconciliation.
- (f) *[Revoked]*
- (1A) In addition to the functions in subclause (1), a **reconciliation participant** that is **adispatchable load purchaser** must obtain and maintain **certification** under Schedule 15.1 to be permitted to perform, or to have performed by an agent or agents, any of the following functions under this Code:
 - (a) *[Revoked]*
 - (b) creating and managing (including validating, estimating, storing, correcting, and archiving) **dispatchable load information**; and
 - (c) providing **dispatchable load information**.
- (1B) *[Revoked]*
- (2) *[Revoked]*

Compare: Electricity Governance Rules 2003 rule 19 part J

Clause 15.38(1): amended, on 1 June 2017, by clause 26(1) of the Electricity Industry Participation Code Amendment (Requirements and Processes for Audits) 2016.

Clause 15.38(1)(a): amended, on 1 February 2016, by clause 99(1) of the Electricity Industry Participation Code Amendment (Code Review Programme) 2015.

Clause 15.38(1)(a) and (f): amended, on 1 November 2018, by clause 118(a) of the Electricity Industry Participation Code Amendment (Code Review Programme) 2018.

Clause 15.38(1)(c)(iv): inserted, on 15 May 2014, by clause 101(1) of the Electricity Industry Participation (Modified Dispatchable Demand) Code Amendment 2013.

Clause 15.38(1)(c)(iii): amended, on 20 December 2021, by clause 66(a) of the Electricity Industry Participation Code Amendment (Code Review Programme) 2019.

Clause 15.38(1)(c)(iv): revoked, on 20 December 2021, by clause 66(b) of the Electricity Industry Participation Code Amendment (Code Review Programme) 2019.

Clause 15.38(1)(d): substituted, on 19 December 2014, by clause 41 of the Electricity Industry Participation Code Amendment (Minor Code Amendments) (No 3) 2014.

Clause 15.38(1)(d): substituted, on 1 February 2016, by clause 99(2) of the Electricity Industry Participation Code Amendment (Code Review Programme) 2015.

Clause 15.38(1)(da) and (db): inserted, on 19 December 2014, by clause 41 of the Electricity Industry Participation Code Amendment (Minor Code Amendments) (No 3) 2014.

Clause 15.38(1)(da) and (db): revoked, on 1 February 2016, by clause 99(3) of the Electricity Industry Participation Code Amendment (Code Review Programme) 2015.

Clause 15.38(1)(f): amended, on 1 February 2016, by clause 99(4) of the Electricity Industry Participation Code Amendment (Code Review Programme) 2015.

Clause 15.38(1A): inserted, on 15 May 2014, by clause 101(2) of the Electricity Industry Participation (Modified Dispatchable Demand) Code Amendment 2013.

Clause 15.38(1B): inserted, on 15 May 2014, by clause 62 of the Electricity Industry Participation (Minor Code Amendments) Code Amendment 2014.

Clause 15.38(2): substituted, on 1 February 2016, by clause 99(5) of the Electricity Industry Participation Code Amendment (Code Review Programme) 2015.

Clause 15.38(2): revoked, on 1 June 2017, by clause 26(2) of the Electricity Industry Participation Code Amendment (Requirements and Processes for Audits) 2016.

Clause 15.38(1): amended, on 1 March 2024, by clause 113(1) of the Electricity Industry Participation Code Amendment (Code Review Programme) 2024.

Clause 15.38(1A): amended, on 1 March 2024, by clause 113(2) of the Electricity Industry Participation Code Amendment (Code Review Programme) 2024.

Clause 15.38(1B): revoked, on 1 March 2024, by clause 113(3) of the Electricity Industry Participation Code Amendment (Code Review Programme) 2024

Participant identifiers

Cross heading Participant identifiers: inserted, on 15 May 2014, by clause 63 of the Electricity Industry Participation (Minor Code Amendments) Code Amendment 2014.

15.39 Participants must use participant identifiers

- (1) Each **participant** must use its **participant identifier**, when required, to correctly identify that **participant's** information.
- (2) A **participant** must apply to the **Authority** in the **prescribed form** for a **participant identifier** at least **5 business days** before the **participant identifier** is required.
- (3) The **Authority** may, by giving written notice to any **participant**, change the **participant identifier** for that **participant**. If the **Authority** does this, the new **participant identifier** for that **participant** will become effective from the date specified in the relevant notice.

Compare: Electricity Governance Rules 2003 rule 20 part J

Clause 15.39(3): amended, on 5 October 2017, by clause 528 of the Electricity Industry Participation Code Amendment (Code Review Programme) 2017.

Schedule 15.1 Certification processes

cl 15.38

Heading Schedule 15.1: amended, on 1 June 2017, by clause 27 of the Electricity Industry Participation Code Amendment (Requirements and Processes for Audits) 2016.

1 Contents of this Schedule

This Schedule sets out—

- (a) *[Revoked]*
- (b) the requirement for—
 - (i) **reconciliation participants** to be **certified** to perform the functions specified in clause 15.38; and
 - (ii) **generators** that are not **reconciliation participants** to be **certified** to perform any of the obligations specified under clauses 13.136 to 13.138; and
- (ba) the process for obtaining and renewing that **certification**.
- (c) *[Revoked]*

Compare: Electricity Governance Rules 2003 clause 1 schedule J1

Clause 1(a): revoked, on 1 June 2017, by clause 28(1) of the Electricity Industry Participation Code Amendment (Requirements and Processes for Audits) 2016.

Clause 1(b): amended, on 1 June 2017, by clause 28(2) of the Electricity Industry Participation Code Amendment (Requirements and Processes for Audits) 2016.

Clause 1(c): revoked, on 1 June 2017, by clause 28(1) of the Electricity Industry Participation Code Amendment (Requirements and Processes for Audits) 2016.

Clause 1(b): replaced, on 1 March 2024, by clause 114(1) of the Electricity Industry Participation Code Amendment (Code Review Programme) 2024

Clause 1(ba): inserted, on 1 March 2024, by clause 114(2) of the Electricity Industry Participation Code Amendment (Code Review Programme) 2024.

2 *[Revoked]*

Compare: Electricity Governance Rules 2003 clause 1A schedule J1

Clause 2: revoked, on 1 February 2016, by clause 100 of the Electricity Industry Participation Code Amendment (Code Review Programme) 2015.

2A Requirement for certification

- (1) Despite clause 15.38(1) and 15.38(1A), a **reconciliation participant** that is required to obtain **certification** under clause 15.38 must obtain **certification** no later than,—
 - (a) in the case of a **reconciliation participant** that is recorded in the **registry** as being responsible for fewer than 100 **ICPs** of the kind described in subclause (2), 12 months after the **reconciliation participant** first performs a function specified in clause 15.38(1); or
 - (b) in every other case, the later of—
 - (i) 6 months after the date on which the **reconciliation participant** first performs, including by using an agent, a function specified in clause 15.38; or
 - (ii) the date on which the **reconciliation participant** is recorded in the **registry** as being responsible for 100 or more **ICPs** of the kind described in subclause (2).
- (2) The kind of **ICP** referred to in subclause (1) is an **ICP** at which there is—
 - (a) 1 or more **category 1 metering installations** and no other kind of **metering installation**; and

(b) no **unmetered load**.

- (3) A **generator** that is not a **reconciliation participant** and that is required to obtain **certification** under clause 13.138C must obtain **certification** no later than 6 months after the date on which the **generator** first performs, including by using an agent, an obligation under clauses 13.136 to 13.138.

Clause 2A: inserted, on 1 June 2017, by clause 29 of the Electricity Industry Participation Code Amendment (Requirements and Processes for Audits) 2016.

Clause 2A(1) and 2A(1)(b)(i): amended, on 1 March 2024, by clause 115(1) and (2) of the Electricity Industry Participation Code Amendment (Code Review Programme) 2024.

Clause 2A(3): inserted, on 1 March 2024, by clause 115(3) of the Electricity Industry Participation Code Amendment (Code Review Programme) 2024.

2B Participants to obtain Authority approval before performing certain functions

- (1) A **participant** that proposes to perform a function listed in clause 15.38 without obtaining **certification** (in reliance on clause 2A) must obtain the **Authority's** prior approval.
- (1A) A **generator** that is not a **reconciliation participant** and that proposes to perform an obligation under clauses 13.136 to 13.138 without obtaining **certification** (in reliance on clause 2A) must obtain the **Authority's** prior approval.
- (2) The **Authority** must give its approval if it is satisfied, on the basis of information provided to it by the **participant** specified in subclause (1) or subclause (1A), that the **participant** complies with the requirements specified in subclause (3) that apply to the **participant**.
- (3) The requirements are that the **participant** must—
- (a) be capable of producing **submission information** accurately;
 - (aa) where required, be capable of providing the **half-hour metering information** required under clauses 13.136 to 13.138;
 - (b) be capable of performing the functions described in clause 15.38(1)(d);
 - (c) be capable of switching an **ICP** in accordance with Schedule 11.3;
 - (d) be capable of managing an **ICP** in accordance with Schedule 11.1;
 - (e) understand its obligations under this Code.

Clause 2B: inserted, on 1 June 2017, by clause 29 of the Electricity Industry Participation Code Amendment (Requirements and Processes for Audits) 2016.

Clause 2B Heading and 2B(1): amended, on 1 March 2024, by clause 116(1) and (2) of the Electricity Industry Participation Code Amendment (Code Review Programme) 2024.

Clause 2B(1A): inserted, on 1 March 2024, by clause 116(3) of the Electricity Industry Participation Code Amendment (Code Review Programme) 2024.

Clause 2B(2): amended, on 1 March 2024, by clause 116(4) of the Electricity Industry Participation Code Amendment (Code Review Programme) 2024.

Clause 2B(3): amended, on 1 March 2024, by clause 116(5) of the Electricity Industry Participation Code Amendment (Code Review Programme) 2024.

3 Performance of participant's obligations by agent

A **participant** may perform any obligation under this Schedule by using an agent, and for that purpose, every act or omission of a **participant's** agent is deemed to be an act or omission of the **participant**.

Compare: Electricity Governance Rules 2003 clause 1B schedule J1

Clause 3 Heading: amended, on 1 March 2024, by clause 117(1) of the Electricity Industry Participation Code Amendment (Code Review Programme) 2024.

Clause 3: amended, on 1 March 2024, by clause 117(2) of the Electricity Industry Participation Code Amendment (Code Review Programme) 2024.

4 Obtaining certification

- (1) A **participant** requiring **certification** to perform the functions specified in clause 15.38 or the obligations under clauses 13.136 to 13.138 must apply in writing to the **Authority** in the **prescribed form**, at least 2 months before the intended date of **certification**.
- (2) When making an application under subclause (1), the **participant** must—
 - (a) promptly provide such other information as the **Authority** may reasonably request; and
 - (b) indicate to the **Authority** the information gathering, processing and management functions the **participant** intends to perform and who it intends to use to perform those functions.
- (3) *[Revoked]*

Compare: Electricity Governance Rules 2003 clauses 3.1 to 3.1B schedule J1

Clause 4(1): amended, on 1 March 2024, by clause 118(1) of the Electricity Industry Participation Code Amendment (Code Review Programme) 2024.

Clause 4(2): amended, on 1 March 2024, by clause 118(2) of the Electricity Industry Participation Code Amendment (Code Review Programme) 2024.

Clause 4(3): revoked, on 1 March 2024, by clause 118(3) of the Electricity Industry Participation Code Amendment (Code Review Programme) 2024.

5 Granting certification

- (1) The **Authority** must grant **certification** to a **reconciliation participant** or **generator** only if—
 - (a) the **Authority** is satisfied, on the basis of an **audit** report provided to the **Authority** under Part 16A, that the **participant** meets the requirements relevant to the functions specified in clause 15.38 or the obligations under clauses 13.136 to 13.138 for which the **participant** is seeking **certification**.
 - (b) *[Revoked]*
- (2) A **participant** is responsible for appointing an **auditor** to undertake the **audit** required by subclause (1).
- (3) *[Revoked]*

Compare: Electricity Governance Rules 2003 clause 3.2 schedule J1

Clause 5(1)(a): amended, on 1 June 2017, by clause 30(1)(a) and (b) of the Electricity Industry Participation Code Amendment (Requirements and Processes for Audits) 2016.

Clause 5(1)(b): revoked, on 1 June 2017, by clause 30(2) of the Electricity Industry Participation Code Amendment (Requirements and Processes for Audits) 2016.

Clause 5(3): revoked, on 1 June 2017, by clause 30(3) of the Electricity Industry Participation Code Amendment (Requirements and Processes for Audits) 2016.

Clause 5(1): amended, on 1 March 2024, by clause 119(1) of the Electricity Industry Participation Code Amendment (Code Review Programme) 2024.

Clause 5(1)(a): amended, on 1 March 2024, by clause 119(2) of the Electricity Industry Participation Code Amendment (Code Review Programme) 2024.

Clause 5(2): amended, on 1 March 2024, by clause 119(3) of the Electricity Industry Participation Code Amendment (Code Review Programme) 2024.

6 Lists of participants

The **Authority** must **publish**, and keep updated—

- (a) a list of **participants certified** under clause 13.138C and clause 15.38 including, for each **participant**, the date on which the **certification** expires.
- (b) *[Revoked]*

Compare: Electricity Governance Rules 2003 clause 3A schedule J1

Clause 6 Heading: amended, on 1 February 2016, by clause 101(1) of the Electricity Industry Participation Code Amendment (Code Review Programme) 2015.

Clause 6: amended, on 1 June 2017, by clause 31 of the Electricity Industry Participation Code Amendment (Requirements and Processes for Audits) 2016.

Clause 6: amended, on 5 October 2017, by clause 529 of the Electricity Industry Participation Code Amendment (Code Review Programme) 2017.

Clause 6(a): amended, on 1 February 2016, by clause 101(2) of the Electricity Industry Participation Code Amendment (Code Review Programme) 2015.

Clause 6(b): revoked, on 1 February 2016, by clause 101(3) of the Electricity Industry Participation Code Amendment (Code Review Programme) 2015.

Clause 6 Heading and 6(a): amended, on 1 March 2024, by clause 120 of the Electricity Industry Participation Code Amendment (Code Review Programme) 2024.

7 Renewal of certification

- (1) **Certification** must not be granted for a term of more than 24 months.
- (2) The **Authority** must renew a **participant's certification** for a further term of not more than 24 months if the **Authority** is satisfied on the basis of an **audit** report provided to the **Authority** under Part 16A that the **participant** continues to meet the requirements specified in clause 5.

Compare: Electricity Governance Rules 2003 clause 3B schedule J1

Clause 7: amended, on 1 June 2017, by clause 32(1) of the Electricity Industry Participation Code Amendment (Requirements and Processes for Audits) 2016.

Clause 7(2): amended, on 1 June 2017, by clause 32(2) of the Electricity Industry Participation Code Amendment (Requirements and Processes for Audits) 2016.

Clause 7(2): amended, on 1 March 2024, by clause 121 of the Electricity Industry Participation Code Amendment (Code Review Programme) 2024.

8 Changes that affect certification

- (1) *[Revoked]*

- (1A) If there is a material change to a **participant's** systems or processes such that an **audit** is required under clause 16A.11, the **Authority** must, on receiving the **audit** report required by that clause, decide whether to continue the **participant's certification**.
- (2) The **Authority** must, by notice to the **participant**, continue the **participant's certification** if the **Authority** is satisfied that the **participant** will continue to meet the requirements in clause 5 after the change has come into effect.
- (3) A **participant's certification** is revoked if—
 - (a) the **participant** fails to provide an **audit** report to the **Authority** under clause 16A.11; or
 - (b) the **Authority** gives written notice to the **participant** that the **Authority** is not satisfied that the **participant** will continue to meet the requirements in clause 5 after the change has come into effect.

Compare: Electricity Governance Rules 2003 clause 3C schedule J1

Clause 8(1): revoked, on 1 June 2017, by clause 33(1) of the Electricity Industry Participation Code Amendment (Requirements and Processes for Audits) 2016.

Clause 8(1A): inserted, on 1 June 2017, by clause 33(2) of the Electricity Industry Participation Code Amendment (Requirements and Processes for Audits) 2016.

Clause 8(2): amended, on 1 June 2017, by clause 33(3) of the Electricity Industry Participation Code Amendment (Requirements and Processes for Audits) 2016.

Clause 8(3): amended, on 1 June 2017, by clause 33(4)(a) of the Electricity Industry Participation Code Amendment (Requirements and Processes for Audits) 2016.

Clause 8(3)(a): amended, on 1 June 2017, by clause 33(4)(b) of the Electricity Industry Participation Code Amendment (Requirements and Processes for Audits) 2016.

Clause 8(3)(b): amended, on 5 October 2017, by clause 530 of the Electricity Industry Participation Code Amendment (Code Review Programme) 2017.

Clause 8(1A), (2) and (3): amended, on 1 March 2024, by clause 122 of the Electricity Industry Participation Code Amendment (Code Review Programme) 2024.

- 8A** *[Revoked]*
Clause 8A: inserted, on 24 May 2013, by clause 5 of the Electricity Industry Participation (Transitional Provisions for New Metering Arrangements) Code Amendment 2013.
Clause 8A(3): amended, on 15 May 2014, by clause 64 of the Electricity Industry Participation (Minor Code Amendments) Code Amendment 2014.
Clause 8A: revoked, on 1 June 2017, by clause 34 of the Electricity Industry Participation Code Amendment (Requirements and Processes for Audits) 2016.
- 9** *[Revoked]*.
Compare: Electricity Governance Rules 2003 clause 5 Schedule J1
Clause 9(5): amended, on 29 August 2013, by clause 23 of the Electricity Industry Participation (Metering Arrangements) Code Amendment 2011.
Clause 9(7): amended, on 21 September 2012, by clause 39 of the Electricity Industry Participation (Minor Amendments) Code Amendment 2012.
Clause 9: revoked, on 1 June 2017, by clause 34 of the Electricity Industry Participation Code Amendment (Requirements and Processes for Audits) 2016.
- 10** *[Revoked]*
Compare: Electricity Governance Rules 2003 clause 6 schedule J1
Clause 10: revoked, on 1 June 2017, by clause 34 of the Electricity Industry Participation Code Amendment (Requirements and Processes for Audits) 2016.
- 11** *[Revoked]*
Compare: Electricity Governance Rules 2003 clause 6A schedule J1
Clause 11: revoked, on 1 June 2017, by clause 34 of the Electricity Industry Participation Code Amendment (Requirements and Processes for Audits) 2016.
- 12** *[Revoked]*
Compare: Electricity Governance Rules 2003 clauses 8.1 and 8.1A schedule J1
Clause 12: revoked, on 1 June 2017, by clause 34 of the Electricity Industry Participation Code Amendment (Requirements and Processes for Audits) 2016.
- 13** *[Revoked]*
Compare: Electricity Governance Rules 2003 clause 8.2 schedule J1
Clause 13: revoked, on 1 June 2017, by clause 34 of the Electricity Industry Participation Code Amendment (Requirements and Processes for Audits) 2016.
- 14** *[Revoked]*
Compare: Electricity Governance Rules 2003 clause 8.2A schedule J1
Clause 14: revoked, on 1 June 2017, by clause 34 of the Electricity Industry Participation Code Amendment (Requirements and Processes for Audits) 2016.
- 15** *[Revoked]*
Compare: Electricity Governance Rules 2003 clause 8.3 schedule J1
Clause 15: revoked, on 1 June 2017, by clause 34 of the Electricity Industry Participation Code Amendment (Requirements and Processes for Audits) 2016.
- 16** *[Revoked]*
Compare: Electricity Governance Rules 2003 clause 8.4 schedule J1
Clause 16: revoked, on 1 June 2017, by clause 34 of the Electricity Industry Participation Code Amendment (Requirements and Processes for Audits) 2016.
- 17** *[Revoked]*
Compare: Electricity Governance Rules 2003 clause 8.5 schedule J1
Clause 17: revoked, on 1 June 2017, by clause 34 of the Electricity Industry Participation Code Amendment (Requirements and Processes for Audits) 2016.

Electricity Industry Participation Code 2010
Schedule 15.1

18 *[Revoked]*

Compare: Electricity Governance Rules 2003 clause 8.6 schedule J1

Clause 18: revoked, on 1 June 2017, by clause 34 of the Electricity Industry Participation Code Amendment (Requirements and Processes for Audits) 2016.

19 *[Revoked]*

Compare: Electricity Governance Rules 2003 clause 8.7 schedule J1

Clause 19: revoked, on 1 June 2017, by clause 34 of the Electricity Industry Participation Code Amendment (Requirements and Processes for Audits) 2016.

Schedule 15.2

Collection of volume information

cl 15.5

1 Contents of this Schedule

This Schedule establishes the required processes, in so far as they relate to the reconciliation process, for—

- (a) collecting **raw meter data**, **interrogating meters**, and deriving **validated meter readings**; and
- (b) creating **estimated readings** and **permanent estimates**; and
- (c) deriving **volume information** from **validated meter readings**, **estimated readings**, and **permanent estimates**; and
- (d) supporting data processing activities.

Compare: Electricity Governance Rules 2003 clause 1 schedule J2

2 Collection of raw meter data by certified reconciliation participant

- (1) This clause applies to each **metering installation** for which a **metering equipment provider** is responsible, except for a **metering installation**—
 - (a) that only the **metering equipment provider** can electronically **interrogate**; or
 - (b) for which the **metering equipment provider** has an arrangement with the **reconciliation participant**, which prevents the **reconciliation participant** from electronically **interrogating** the **metering installation**.
- (2) A **reconciliation participant** must obtain **raw meter data** used to determine **volume information**—
 - (a) from the **services access interface** of the **metering installation**; or
 - (b) if the **raw meter data** can only be obtained from the **metering equipment provider's back office**, from the **metering equipment provider**.
- (3) A **reconciliation participant** must ensure that the **interrogation** cycle for each **metering installation** that it **interrogates** does not exceed the maximum **interrogation** cycle in the **registry**.
- (4) A **reconciliation participant** must **interrogate** a **metering installation** at least once in each maximum **interrogation** cycle for the **metering installation**.
- (5) A **reconciliation participant** must, when electronically **interrogating** a **metering installation**,—
 - (a) ensure that the **interrogation** and processing system electronically monitors and corrects its internal clocks against a time source with a verifiable standard at a frequency sufficient, but no longer than 1 week, to ensure the internal clock is accurate, when carrying out an **interrogation**, to within ± 5 seconds of—
 - (i) **New Zealand standard time**; or
 - (ii) **New Zealand daylight time**; and
 - (b) compare the time on the internal clock of the **data storage device** with the time on the **interrogation** and processing system clock; and
 - (c) calculate the time error for the **data storage device**; and

- (d) if the time error calculated under paragraph (c) is equal to or less than the applicable time error set out in Table 1, correct the clock of the **data storage device**; and
 - (e) if the time error calculated under paragraph (c) is greater than the applicable time error set out in Table 1,—
 - (i) correct the clock of the **data storage device**; and
 - (ii) compare the time of the clock with the time of the **interrogation** and processing system clock; and
 - (iii) correct any affected **raw meter data**; and
 - (f) download the **event log**.
- (6) The **reconciliation participant** must record in the **interrogation** and processing system logs, the time, the date, and the extent of any change in the internal clock setting in the **metering installation**.

Table 1: Maximum permitted time errors

Metering installation category	Half-hour metering installations (seconds)	Non half-hour metering installations (seconds)
1	±30	±60
2	±10	±60
3	±10	NA
4	±10	NA
5	±5	NA

Compare: Electricity Governance Rules 2003 clause 2 schedule J2
 Clause 2: substituted, on 29 August 2013, by clause 24 of the Electricity Industry Participation (Metering Arrangements) Code Amendment 2011.

2A Meter readings from bridged meters

If a **meter** is bridged in accordance with clause 10.33C, the **trader** responsible for the **ICP** must determine **meter readings** for that **meter** as follows:

- (a) if a check **meter** or **data storage device** is installed at the **metering installation**, by substituting data from the check **meter** or **data storage device** for the period the **meter** was bridged; or
- (b) in the absence of any check **meter** or **data storage device**, by determining **meter readings** for the period the **meter** was bridged from—
 - (i) **half hour** data from another period where the **trader** considers the pattern of consumption is materially similar to the period during which the **meter** was bridged; or
 - (ii) a non **half hour estimated reading** that the **trader** considers is the best estimate of the quantity of **electricity** consumed during the period the **meter** was bridged.

Clause 2A: inserted, on 1 February 2021, by clause 49 of the Electricity Industry Participation Code Amendment (Metering and Related Registry Processes) 2020.

3 Source of volume information

- (1) A **meter reading** must, in accordance with the relevant **reconciliation participant's certified** processes and procedures, and using its **certified** facilities, be sourced directly from **raw meter data**, and if appropriate, be derived and calculated from financial records.
- (2) A **validated meter reading** must be derived from a **meter reading**. A **meter reading** that is provided by a **consumer** may be used as a **validated meter reading** only if another set of **validated meter readings** that has not been provided by the **consumer** is used during the validation process specified in clauses 16 and 17.
- (3) An **estimated reading** and a **permanent estimate** must be clearly identified as an estimate at source and in an exchange of metering data or **volume information** between **participants** (excluding the **reconciliation manager**).
- (4) **Volume information** must be directly derived, in accordance with this Schedule, from—
 - (a) **validated meter readings**; or
 - (b) **estimated readings**; or
 - (c) **permanent estimates**.
- (5) A **reconciliation participant** must ensure that all **raw meter data** used to derive **volume information** in accordance with this Schedule is not rounded or truncated from the stored data from the **metering installation**.

Compare: Electricity Governance Rules 2003 clause 3 schedule J2

Clause 3(5): inserted, on 1 February 2016, by clause 102 of the Electricity Industry Participation Code Amendment (Code Review Programme) 2015.

4 Permanence for the purposes of reconciliation

- (1) Only **volume information** created using **validated meter readings**, or if such values are unavailable, **permanent estimates**, has permanence within the reconciliation processes (unless subsequently found to be in error).
- (2) The relevant **reconciliation participant** must, at the earliest opportunity, and no later than the month 14 revision cycle, replace **volume information** created using **estimated readings** with **volume information** created using **validated meter readings**.
- (3) If, despite having used reasonable endeavours for at least 12 months, a **reconciliation participant** has been unable to obtain a **validated meter reading**, the **reconciliation participant** must replace **volume information** created using an **estimated reading** with **volume information** created using a **permanent estimate** in place of a **validated meter reading**.

Compare: Electricity Governance Rules 2003 clause 4 schedule J2

Clause 4(2) and (3): replaced, on 1 February 2019, by clause 119(1) and (2) of the Electricity Industry Participation Code Amendment (Code Review Programme) 2018.

Meter interrogation for non half hour metering

5 Non half-hour metering information

A **reconciliation participant** must, when manually **interrogating** a **non half-hour metering installation**, if the relevant parts of the **metering installation** are visible and it is safe to do so,—

- (a) obtain the **meter** register value; and
- (b) ensure seals are present and intact; and
- (c) check for phase failure if the **meter** supports it; and
- (d) check for signs of tampering or damage; and
- (e) check for electrically unsafe situations, where “electrically unsafe” has the meaning given to it in the Electricity (Safety) Regulations 2010.

Compare: Electricity Governance Rules 2003 clause 5.1 schedule J2

Clause 5: substituted, on 29 August 2013, by clause 25 of the Electricity Industry Participation (Metering Arrangements) Code Amendment 2011.

Clause 5(e): amended, on 5 October 2017, by clause 531 of the Electricity Industry Participation Code Amendment (Code Review Programme) 2017.

6 When non half hour meter readings apply

Non **half hour meter readings** are deemed to apply—

- (a) if the non **half hour meter reading** is also a **switch event meter reading**—
 - (i) for the gaining **trader**, from 0000 hours on the day of the relevant **event date**; and
 - (ii) for the losing **trader**, at 2400 hours at the end of the day before the relevant **event date**; or
- (b) in all other cases, from 0000 hours on the day after the last **meter interrogation** up to and including 2400 hours on the day of the **meter interrogation**.

Compare: Electricity Governance Rules 2003 clause 5.2 schedule J2

Clause 6: substituted, on 9 October 2015, by clause 27 of the Electricity Industry Participation Code Amendment (ICP Switching) 2014.

7 Non half hour meter reading during period of supply

- (1) Each **reconciliation participant** must ensure that a **validated meter reading** is obtained in respect of every **meter** register for every non **half hour** metered **ICP** for which it is responsible, at least once during the period of supply to the **ICP** by the **reconciliation participant**, and used to create **volume information**. This may be a **validated meter reading** at the time the **ICP** is switched to, or from, the **reconciliation participant**.
- (2) If **exceptional circumstances** prevent a **reconciliation participant** from obtaining the **validated meter reading** described in subclause (1), the **reconciliation participant** is not required to comply with subclause (1).

Compare: Electricity Governance Rules 2003 clauses 5.3 and 5.3A schedule J2

8 Non half hour meter reading on 12 monthly basis

- (1) Each **reconciliation participant** must ensure that, at least once every 12 months, a **validated meter reading** is obtained for every **meter** register for non **half hour** metered **ICPs** at which the **reconciliation participant** trades continuously for each 12 month period. In carrying out this obligation—

- (a) each **reconciliation participant** must report to the **Authority**, in relation to each **NSP**, the percentage of the **ICPs** from which **consumption information** was collected and reported into the reconciliation process in the previous 12 month period. This report must be submitted no later than 20 **business days** after the end of each month; and
 - (b) if the percentage reported in accordance with paragraph (a) is less than 100%, the **Authority** may, from time to time, require the **reconciliation participant** to explain why that level was not achieved and to describe the steps that are being taken to achieve a level of performance that, in the **Authority's** assessment, is reasonable.
- (2) If **exceptional circumstances** prevent a **reconciliation participant** from obtaining the **validated meter reading** described in subclause (1), the **reconciliation participant** is not required to comply with subclause (1).
- Compare: Electricity Governance Rules 2003 clauses 5.4 and 5.4A schedule J2
Clause 8(1): amended, on 5 October 2017, by clause 532(a) and (b) of the Electricity Industry Participation Code Amendment (Code Review Programme) 2017.
Clause 8(1): amended, on 20 December 2021, by clause 67 of the Electricity Industry Participation Code Amendment (Code Review Programme) 2019.

9 Non half hour meter reading every 4 months

- (1) Each **reconciliation participant** must ensure, in relation to each **NSP**, that a **validated meter reading** is obtained, at least once every 4 months, for 90% of the non **half hour** metered **ICPs** at which the **reconciliation participant** trades continuously for each 4 months for which **consumption information** is required to be reported into the reconciliation process. In carrying out this obligation—
- (a) each **reconciliation participant** must report to the **Authority** the percentage, in relation to each **NSP**, of the **ICPs** from which **consumption information** was collected and reported into the reconciliation process in the previous 4 month period. This report must be submitted no later than 20 **business days** after the end of each month; and
 - (b) if the percentage reported in accordance with paragraph (a) is less than 90% in relation to any **NSP**, the **Authority** may, from time to time, require the **reconciliation participant** to explain why that level was not achieved and to describe the steps that are being taken to achieve acceptable performance.
- (2) If **exceptional circumstances** prevent a **reconciliation participant** from obtaining the **validated meter reading** described in subclause (1), the **reconciliation participant** is not required to comply with subclause (1).
- (3) The **reconciliation participant** must report to the **Authority** monthly on a rolling 4 month basis the percentage of non **half hour meter interrogations** within that period.
- Compare: Electricity Governance Rules 2003 clauses 5.5 and 5.5A schedule J2
Clause 9(1) and (3): amended, on 5 October 2017, by clause 533 of the Electricity Industry Participation Code Amendment (Code Review Programme) 2017.

10 Interrogation log

To verify the accuracy of **raw meter data** collected during **interrogation** of non **half hour metering**, a log must be produced consisting of the following as a minimum:

- (a) the means to establish the identity of the individual **meter** reader:

- (b) the **ICP identifier**, and the **meter** and register identification:
- (c) the method being used for this **interrogation** and the device ID of equipment being used for **interrogation** of the **meter**:
- (d) the date and time of the **meter interrogation**.

Compare: Electricity Governance Rules 2003 clause 5.6 schedule J2

11 Metering installation that is electronically interrogated

- (1) A **reconciliation participant** must, as required under clause 2(2), obtain **raw meter data** from the **services access interface** for an electronically **interrogated metering installation**. This may be carried out through the use of portable devices or remotely by the use of a recognised communications medium.
- (2) **Raw meter data** obtained by the electronic **interrogation** of a **metering installation** must consist of the following as a minimum:
 - (a) the unique identifier of the **data storage device** in the **metering installation**:
 - (b) the time from the **data storage device** at the commencement of the download, unless the time is within specification and the **interrogation** log automatically records the time of **interrogation**:
 - (c) the **metering information**, which represents the quantity of **electricity** conveyed at the **point of connection**, including the date and time stamp or index marker for each **half hour** period. This may be limited to the **metering information** accumulated since the last **interrogation**:
 - (d) the **event log**, which may be limited to the events information accumulated since the last **interrogation**:
 - (e) for all **metering information**, an **interrogation** log generated by the **interrogation software** to record details of all **interrogations**. The **reconciliation participant** responsible for collecting the data must peruse the **interrogation** log and take appropriate action if problems are apparent. Alternatively, this process may be an automated **software** function that flags exceptions.
- (3) For the purposes of subclause (2)(e), the **interrogation** log must form part of the **interrogation** audit trail and must contain the following as a minimum:
 - (a) the date of **interrogation**:
 - (b) the time of commencement of **interrogation**:
 - (c) the operator identification (if available):
 - (d) the unique identifier of the **data storage device**:
 - (e) the time errors outside the range specified in Table 1 of clause 2:
 - (f) the method of **interrogation**:
 - (g) the identifier of the reading device used for **interrogation** (if applicable).

Compare: Electricity Governance Rules 2003 clause 6.1 schedule J2

Clause 11: substituted, on 29 August 2013, by clause 26 of the Electricity Industry Participation (Metering Arrangements) Code Amendment 2011.

12 *[Revoked]*

Compare: Electricity Governance Rules 2003 clause 6.2 schedule J2

Clause 12 and Table 1: revoked, on 29 August 2013, by clause 27 of the Electricity Industry Participation (Metering Arrangements) Code Amendment 2011

13 Trading period

The **trading period** duration, which is normally 30 minutes, must be within $\pm 0.1\%$ (± 2 seconds).

Compare: Electricity Governance Rules 2003 clause 6.3 schedule J2

14 *[Revoked]*

Compare: Electricity Governance Rules 2003 clause 6.4 schedule J2

Clause 14: amended, on 21 September 2012, by clause 40 of the Electricity Industry Participation (Minor Amendments) Code Amendment 2012.

Clause 14: amended, on 29 August 2013, by clause 28 of the Electricity Industry Participation (Metering Arrangements) Code Amendment 2011.

Clause 14: revoked, on 1 February 2016, by clause 103 of the Electricity Industry Participation Code Amendment (Code Review Programme) 2015.

15 Half hour estimates

- (1) If a **reconciliation participant** is unable to **interrogate** an electronically **interrogated metering installation** before the deadline for providing **submission information** or **dispatchable load information**, the **reconciliation participant** must submit to the **reconciliation manager** its best estimate of the quantity of **electricity** that was purchased or sold in each **trading period** during any applicable **consumption period** for that **metering installation**.
- (2) The **reconciliation participant** must use reasonable endeavours to ensure that estimated **submission information** is within the percentage specified by the **Authority**.

Compare: Electricity Governance Rules 2003 clause 6.5 schedule J2

Clause 15(1): amended, on 29 August 2013, by clause 29 of the Electricity Industry Participation (Metering Arrangements) Code Amendment 2011.

Clause 15(1): amended, on 15 May 2014, by clause 102 of the Electricity Industry Participation (Modified Dispatchable Demand) Code Amendment 2013.

Validation

16 Non half-hour meter readings and estimated readings

- (1) All non **half hour meter readings** and **estimated readings** must be checked for validity by the relevant **reconciliation participant** after each **interrogation**.
- (2) Each validity check of non **half hour meter readings** and **estimated readings** must include the following:
 - (a) confirmation that the **meter reading** or **estimated reading** relates to the correct **ICP, meter**, and register:
 - (b) checks for invalid dates and times:
 - (c) confirmation that the **meter reading** or **estimated reading** lies within an acceptable range compared with the expected pattern, previous pattern or trend:
 - (d) confirmation that there is no corruption of the data, including unexpected 0 values.

Compare: Electricity Governance Rules 2003 clause 7.1 schedule J2

17 Electronic meter readings and estimated readings

- (1) All **meter readings** obtained by electronic **interrogation** and **estimated readings** must be checked for validity by the relevant **reconciliation participant**.

- (2) Each validity check of a **meter reading** obtained by electronic **interrogation** and each **estimated reading** must be at a frequency that will allow a further **interrogation** of the **data storage device** before the data is overwritten within the **data storage device** and before the data can be used for any purpose under this Code.
- (3) *[Revoked]*
- (4) Each validity check of a **meter reading** obtained by electronic **interrogation** or an **estimated reading** must include the following:
- (a) checks for missing data;
 - (b) checks for invalid dates and times;
 - (c) checks of unexpected 0 values;
 - (d) comparison with expected or previous flow patterns;
 - (e) comparison of **meter readings** with data on any **data storage device** registers that are available;
 - (f) a review of the **meter** and **data storage device** event log for any event that could have affected the integrity of the **metering data**;
 - (g) a review of the relevant **metering data** if there was an event that could have affected the integrity of the **metering data**.
- (5) A **reconciliation participant** must, if it finds an event that could have affected the integrity of the **metering data** or an event is reported to it under clause 8(5A)(d) of Schedule 10.6,—
- (a) investigate and remediate the event if the **metering equipment provider** responsible for the **metering installation** is not responsible for investigating and remediating the event; and
 - (b) advise the **metering equipment provider** responsible for the relevant **metering installation** of the event if the investigation finds that the event may affect the integrity or operation of the **metering installation**.

Compare: Electricity Governance Rules 2003 clause 7.2 schedule J2

Clause 17 Heading: amended, on 29 August 2013, by clause 15 of the Electricity Industry Participation (Metering Arrangements) Code Amendment 2013.

Clause 17(1) and (2): substituted, on 29 August 2013, by clause 30(a) of the Electricity Industry Participation (Metering Arrangements) Code Amendment 2011.

Clause 17(3): revoked, on 29 August 2013, by clause 30(b) of the Electricity Industry Participation (Metering Arrangements) Code Amendment 2011.

Clause 17(4): amended, on 29 August 2013, by clause 30(c) of the Electricity Industry Participation (Metering Arrangements) Code Amendment 2011.

Clause 17(4): amended, on 29 August 2013, by clause 9 of the Electricity Industry Participation (Metering Arrangements) Code Amendment 2011, Amendment 2013 (No 2)

Clause 17(4)(f): amended, on 15 May 2014, by clause 65 of the Electricity Industry Participation (Minor Code Amendments) Code Amendment 2014.

Clause 17(4)(f): replaced, on 1 February 2021, by clause 50(1)(a) of the Electricity Industry Participation Code Amendment (Metering and Related Registry Processes) 2020.

Clause 17(4)(g): inserted, on 1 February 2021, by clause 50(1)(b) of the Electricity Industry Participation Code Amendment (Metering and Related Registry Processes) 2020.

Clause 17(5): inserted, on 1 February 2021, by clause 50(2) of the Electricity Industry Participation Code Amendment (Metering and Related Registry Processes) 2020.

18 Archiving and storing of raw meter data

- (1) A **reconciliation participant** who is responsible for **interrogating a metering installation** under this Part must archive all **raw meter data** downloaded or collected, and any changes to the **raw meter data**, for not less than 48 months in accordance with clause 8(6) of Schedule 10.6 with all necessary amendments.

- (2) Each **reconciliation participant** must ensure that procedures are in place to ensure that **raw meter data** for which it is responsible cannot be accessed by unauthorised personnel.
- (3) Each **reconciliation participant** must ensure that **meter readings** cannot be modified without an audit trail being created.
Compare: Electricity Governance Rules 2003 clause 8 schedule J2
Clause 18(1): substituted, on 29 August 2013, by clause 31 of the Electricity Industry Participation (Metering Arrangements) Code Amendment 2011.

19 Correction of meter readings

- (1) If a **reconciliation participant** detects errors while validating non **half hour meter readings**, the **reconciliation participant** must—
 - (a) confirm the original **meter reading** by carrying out another **meter reading**; and
 - (b) if the second **meter reading** confirms that the original **meter reading** is erroneous, replace the original **meter reading** with the second **meter reading** (even if the second **meter reading** is at a different date).
- (1A) If a **reconciliation participant** detects errors while validating non **half hour meter readings**, but the **reconciliation participant** cannot confirm the original **meter reading** or replace it with a **meter reading** from another **interrogation**, the **reconciliation participant** must—
 - (a) substitute the original **meter reading** with an **estimated reading** that is marked as an estimate; and
 - (b) subsequently replace the **estimated reading** in accordance with clause 4(2).
- (2) If a **reconciliation participant** detects errors while validating **half-hour meter readings**, the **reconciliation participant** must correct the **meter readings** as follows:
 - (a) if the relevant **metering installation** has a check **meter** or **data storage device**, substitute the original **meter reading** with data from the check **meter** or **data storage device**; or
 - (b) if the relevant **metering installation** does not have a check **meter** or **data storage device**, substitute the original **meter reading** with data from another period provided—
 - (i) the total of all substituted intervals matches the total consumption recorded on a **meter**, if available; and
 - (ii) the **reconciliation participant** considers the pattern of consumption to be materially similar to the period in error.
- (3) A **reconciliation participant** may use **error compensation** and **loss compensation** as part of the process of determining accurate data. Whatever methodology is used, the **reconciliation participant** must document the compensation process and comply with audit trail requirements set out in this Code.
- (4) In correcting a **meter reading** in accordance with this clause, a **reconciliation participant** must not overwrite the **raw meter data**. If the **raw meter data** and the **meter readings** are the same, the **reconciliation participant** must use the processing or data correction application to—
 - (a) make an automatic secure backup of the affected data; and
 - (b) archive the affected data.
- (5) If a **reconciliation participant** corrects or alters data under this clause, the **reconciliation participant** must generate and archive a journal that contains the following information:

- (a) the date of the correction or alteration; and
- (b) the time of the correction or alteration; and
- (c) the operator identifier for the person within the **reconciliation participant** who made the correction or alteration; and
- (d) the **half hour meter reading** data or the non **half hour meter reading** data corrected or altered, and the total difference in volume of such corrected or altered data; and
- (e) the technique used to arrive at the corrected data; and
- (f) the reason for the correction or alteration.

Compare: Electricity Governance Rules 2003 clause 9 schedule J2

Clause 19(2): amended, on 29 August 2013, by clause 32 of the Electricity Industry Participation (Metering Arrangements) Code Amendment 2011.

Clause 19: replaced, on 1 November 2018, by clause 120 of the Electricity Industry Participation Code Amendment (Code Review Programme) 2018.

20 Data transmission

Transmissions and transfers of data related to metering between **reconciliation participants** or **reconciliation participant's** agents, for the purposes of this Code, must be carried out electronically, using systems that ensure the security and integrity of the data transmitted and received.

Compare: Electricity Governance Rules 2003 clause 10 schedule J2

21 Audit trails

- (1) Each **reconciliation participant** must ensure that a complete audit trail exists for all data gathering, validation and processing functions of the **reconciliation participant**.
- (2) The audit trail must—
 - (a) include details of information—
 - (i) provided to and received from the **registry manager**; and
 - (ii) provided to and received from the **reconciliation manager**; and
 - (iii) provided and received from other **reconciliation participants** and their agents; and
 - (b) cover all **raw meter data** and any changes to the **raw meter data** archived under clause 18.
- (3) Logs of communications and processing activities must form part of the audit trail, including if automated processes are in operation.
- (4) Logs must be printed and filed as hard copy or maintained as data files, in a secure form, along with other archived information, and must include (at a minimum) the following:
 - (a) an activity identifier; and
 - (b) the date and time of the activity; and
 - (c) the operator identifier for the person within the **reconciliation participant** who performed the activity.
- (5) A **reconciliation participant** must collect all relevant data used by the **reconciliation participant** to determine **profile** data, including external control equipment operation logs, and archive that data in accordance with clause 18.

Compare: Electricity Governance Rules 2003 clause 11.1 to 11.3 schedule J2

Clause 21(2)(a)(i): amended, on 5 October 2017, by clause 534 of the Electricity Industry Participation Code Amendment (Code Review Programme) 2017.

Electricity Industry Participation Code 2010
Schedule 15.2

Clause 21(2)(a)(i): amended, on 1 November 2018, by clause 121(1) of the Electricity Industry Participation Code Amendment (Code Review Programme) 2018.

Clause 21(2)(b): substituted, on 29 August 2013, by clause 33(a) of the Electricity Industry Participation (Metering Arrangements) Code Amendment 2011.

Clause 21(4): amended, on 1 November 2018, by clause 121(2) of the Electricity Industry Participation Code Amendment (Code Review Programme) 2018.

Clause 21(5): amended, on 29 August 2013, by clause 33(b) of the Electricity Industry Participation (Metering Arrangements) Code Amendment 2011.

22 *[Revoked]*

Compare: Electricity Governance Rules 2003 clause 11.4 schedule J2

Clause 22: revoked, on 1 November 2018, by clause 122 of the Electricity Industry Participation Code Amendment (Code Review Programme) 2018.

Schedule 15.3

Calculation and provision of submission information

cl 15.4

1 Contents of this schedule

This Schedule provides for—

- (a) the processing of **raw meter data** and supporting information to create **submission information**; and
- (b) the delivery of **submission information** to the **reconciliation manager**.

Compare: Electricity Governance Rules 2003 clause 1 schedule J3

Creation of submission information

2 Reconciliation participants to prepare information

- (1) If a **reconciliation participant** is required to prepare **submission information** for an **NSP** for the relevant **consumption period** in accordance with this Code, the **submission information** for each **ICP** about which information is provided under clause 11.7(2)—
 - (aa) must comprise all **volume information** for the **ICP**:
 - (a) must comprise **half hour volume information** for the total metered quantity of **electricity** for each category 3 or higher **metering installation**;
 - (ab) must not comprise **half hour volume information** for a **non half-hour metering installation**;
 - (ac) must comprise either **half hour volume information** or non **half hour volume information** for the total metered quantity of **electricity** for each **metering installation** that—
 - (i) is a **category 1 metering installation** or **category 2 metering installation**; and
 - (ii) is a **half-hour metering installation**;
 - (ad) must comprise non **half hour volume information** calculated under clauses 4 to 6 (as applicable) for the total metered quantity of **electricity** for each **metering installation** that—
 - (i) is a **category 1 metering installation** or **category 2 metering installation**; and
 - (ii) contains only non **half-hour metering**;
 - (ae) if a **metering installation** is a **category 1 metering installation** or **category 2 metering installation**, and the **metering installation** contains **half-hour metering** and **non half-hour metering**, may comprise—
 - (i) a combination of—
 - (A) **half hour volume information** for the **half-hour metering**; and
 - (B) non **half hour volume information** calculated under clauses 4 to 6 (as applicable) for the **non half-hour metering**; or
 - (ii) non **half hour volume information** for the total metered quantity of **electricity** for the **metering installation**;
- (b) *[Revoked]*
- (c) must include **unmetered load** quantities for each **ICP** that has **unmetered load** associated with it, which must be derived from the quantity recorded in the

- registry** against the relevant **ICP** and the number of days in the period, the **distributed unmetered load** database, or other sources of relevant information.
- (1A) However, a **reconciliation participant** need not comply with subclause (1)(a) to (ae) if—
- (a) the **reconciliation participant** is using a **profile** approved in accordance with Schedule 15.5; and
 - (b) the approved **profile** allows the **reconciliation participant** to prepare **submission information** that does not comply with subclause (1)(a) to (ae); and
 - (c) the **reconciliation participant** complies with the **submission information** requirements set out in the approved **profile**.
- (2) To create non **half hour submission information**, a **reconciliation participant** must only use information that is dependent on a **control device** if—
- (a) the **certification** of the **control device** is recorded in the **registry**; or
 - (b) the **metering installation** in which the **control device** is located is an **interim certified metering installation**.
- (3) To create **submission information** for a **point of connection** for which it is responsible, a **reconciliation participant** must use **volume information** from each **metering installation** for the **point of connection**.
- (4) For the purposes of subclause (3), the **reconciliation participant** must calculate the **volume information** by applying to the **raw meter data** obtained from each **metering installation**—
- (a) for each **ICP**, the **compensation factor** recorded in the **registry** for the **metering installation**; or
 - (b) for each **NSP**, the **compensation factor** recorded in the **metering installation's** most recent **certification report**.

Compare: Electricity Governance Rules 2003 clause 2.1 schedule J3

Clause 2: substituted, on 29 August 2013, by clause 34 of the Electricity Industry Participation (Metering Arrangements) Code Amendment 2011.

Clause 2(1): amended, on 1 November 2018, by clause 123(1) of the Electricity Industry Participation Code Amendment (Code Review Programme) 2018.

Clause 2(1)(aa): inserted, on 1 November 2018, by clause 123(2) of the Electricity Industry Participation Code Amendment (Code Review Programme) 2018.

Clause 2(1)(a): replaced, on 1 November 2018, by clause 123(3) of the Electricity Industry Participation Code Amendment (Code Review Programme) 2018.

Clause 2(1)(ab)-(ae): inserted, on 1 November 2018, by clause 123(3) of the Electricity Industry Participation Code Amendment (Code Review Programme) 2018.

Clause 2(1)(b): revoked, on 1 November 2018, by clause 123(4) of the Electricity Industry Participation Code Amendment (Code Review Programme) 2018.

Clause 2(1)(c): amended, on 15 May 2014, by clause 66 of the Electricity Industry Participation (Minor Code Amendments) Code Amendment 2014.

Clause 2(1)(c): amended, on 1 November 2018, by clause 123(5) of the Electricity Industry Participation Code Amendment (Code Review Programme) 2018.

Clause 2(1A): inserted, on 1 November 2018, by clause 123(6) of the Electricity Industry Participation Code Amendment (Code Review Programme) 2018.

Clause 2(3): replaced, on 1 November 2018, by clause 123(7) of the Electricity Industry Participation Code Amendment (Code Review Programme) 2018.

3 Historical estimates and forward estimates

- (1) Each **reconciliation participant** must, for each **ICP** that has a non **half hour metering installation**, allocate **volume information** derived from **validated meter readings**, **estimated readings** or **permanent estimates**, to **consumption periods** using the

techniques described in clauses 4 to 7 to create **historical estimates** and **forward estimates**.

- (2) Each estimate that is a **forward estimate** or an **historical estimate**, must be clearly identified as such.
- (3) If a **validated meter reading** is not available for the purpose of clauses 4 and 5, a **permanent estimate** may be used in place of a **validated meter reading**.

Compare: Electricity Governance Rules 2003 clause 2.2 schedule J3

Clause 3(1): amended, on 31 December 2021, by clause 68 of the Electricity Industry Participation Code Amendment (Code Review Programme) 2019.

4 **Historical estimates with seasonal adjustment**

The methodology that must be used by each **reconciliation participant** to prepare an **historical estimate of volume information** for each **ICP** when the relevant **seasonal adjustment shape** is available and the **reconciliation participant** is not using an approved **profile** in accordance with clause 4A, is as follows:

- (a) if the period between any 2 consecutive **validated meter readings** encompasses an entire **consumption period**, an **historical estimate** must be prepared in accordance with the following formula:

$$HE_{ICP} = kWh_p \times A / B$$

where

HE_{ICP} is the quantity of **electricity** allocated to a **consumption period** for an **ICP**

kWh_p is the difference in kWh between the last **validated meter reading** before the **consumption period** and the 1st **validated meter reading** after the **consumption period**

A is the sum of the **seasonal adjustment shape** values for the **consumption period**

B is the sum of the **seasonal adjustment shape** values for the same time period as is covered by kWh_p as published by the **reconciliation manager**:

- (b) if the period between any 2 consecutive **validated meter readings** encompasses the 1st part of a **consumption period** and the period between the 2nd **validated meter reading** and the subsequent **validated meter reading** encompasses the rest of that **consumption period**, an **historical estimate** must be prepared in accordance with the following formula:

$$HE_{ICP} = kWh_{p1} \times A_1 / B_1 + kWh_{p2} \times A_2 / B_2$$

where

- HE_{ICP} is the quantity of **electricity** allocated to a **consumption period** for an **ICP**
- kWh_{P1} is the difference in kWh between the last **validated meter reading** before the **consumption period** and the **validated meter reading** during the **consumption period**
- A_1 is the sum of the **seasonal adjustment shape** values for the relevant days in the 1st part of the **consumption period**
- B_1 is the sum of the **seasonal adjustment shape** values for the same time period as is covered by kWh_{P1}
- kWh_{P2} is the difference in kWh between the first **validated meter reading** during the **consumption period** and the 1st **validated meter reading** after the **consumption period**
- A_2 is the sum of the **seasonal adjustment shape** values for the relevant days in the latter part of the **consumption period**
- B_2 is the sum of the **seasonal adjustment shape** values for the same time period as is covered by kWh_{P2} .

Compare: Electricity Governance Rules 2003 clauses 2.2.1 schedule J3
Clause 4: amended, on 31 December 2021, by clause 69(1) and (2) of the Electricity Industry Participation Code Amendment (Code Review Programme) 2019.

4A **Historical estimates using approved profile**

If the **Authority** has approved a **profile** for the purpose of apportioning **volume information** (in kWh) to part or full **consumption periods**, a **reconciliation participant**—

- (a) may use the **profile** despite the relevant **seasonal adjustment shape** being available; and
- (b) if it uses the **profile**, must otherwise prepare the **historical estimate** in accordance with the methodology in clause 4.

Clause 4A: inserted, on 31 December 2021, by clause 70 of the Electricity Industry Participation Code Amendment (Code Review Programme) 2019

5 **Historical estimates without seasonal adjustment**

If a **seasonal adjustment shape** is not available, either due to timing (for the provision of **submission information** by the 4th **business day** of each **reconciliation period**) or for any other reason, and the **reconciliation participant** is not using an approved **profile** under clause 4A, the methodology for preparing an **historical estimate** of **volume information** for each **ICP** must be the same as in clause 4, except that the relevant quantities kWh_{Px} must be prorated as determined by the **reconciliation participant** using its own methodology or on a flat shape basis using the relevant number of days that are—

- (a) within the **consumption period**; and
- (b) within the period covered by kWh_{Px} .

Compare: Electricity Governance Rules 2003 clause 2.2.2 schedule J3
Clause 5: amended, on 31 December 2021, by clause 71 of the Electricity Industry Participation Code Amendment (Code Review Programme) 2019

6 Forward estimates

- (1) A **forward estimate** is an estimation of the total quantity of **electricity** that flowed through an **ICP** during all or part of a **consumption period**.
- (2) A **forward estimate** may be used only for a period for which an **historical estimate** cannot be calculated.
- (3) The methodology used for calculating a **forward estimate** may be determined at the discretion of the **reconciliation participant**, and only if the **reconciliation participant** ensures that the accuracy of its initial **submission information** against each subsequent revision cycle **submission information** for each **balancing area** is within the percentage of error specified and **published**, from time to time, by the **Authority**.

Compare: Electricity Governance Rules 2003 clause 2.2.3 schedule J3

7 Compulsory meter reading after profile change

- (1) If a **reconciliation participant** changes the **profile** associated with a **meter**, it must, when determining the **volume information** for that **meter** and its respective **ICP**, use a **validated meter reading** or **permanent estimate** on the day on which the **profile** change is to take effect.
- (2) The **reconciliation participant** must use the **volume information** from that **validated meter reading** or **permanent estimate** to calculate the relevant **historical estimates** of each **profile** for that **meter**.

Compare: Electricity Governance Rules 2003 clause 2.2.4 schedule J3

8 Provision of submission information to reconciliation manager

- (1) For each **metering installation** for which it is responsible that is category 3 or higher, a **reconciliation participant** must provide **half hour submission information** to the **reconciliation manager**.
- (2) For each **half-hour metering installation** for which it is responsible that is a **category 1 metering installation** or **category 2 metering installation**, a **reconciliation participant** must provide to the **reconciliation manager**—
 - (a) **half hour submission information**; or
 - (b) non **half hour submission information**; or
 - (c) a combination of **half hour submission information** and non **half hour submission information** if—
 - (i) the **half-hour metering installation** contains a combination of **half-hour metering** and non **half-hour metering**; and
 - (ii) clause 2(1)(ae) of this Schedule 15.3 applies.
- (3) For each non **half-hour metering installation** for which it is responsible, a **reconciliation participant** must provide non **half hour submission information** to the **reconciliation manager**.
- (4) However, a **reconciliation participant** need not comply with subclause (2) and subclause (3) if—
 - (a) the **reconciliation participant** is using a **profile** approved in accordance in Schedule 15.5; and

- (b) the approved **profile** allows the **reconciliation participant** to provide **half hour submission information** from a non **half-hour metering installation**; and
 - (c) the **reconciliation participant** provides **submission information** that complies with the requirements set out in the approved **profile**.
- (5) For any **unmetered load** at an **ICP** for which it is responsible, regardless of the category of any **metering installation** at the **ICP**, a **reconciliation participant** must provide non **half hour submission information** to the **reconciliation manager** unless—
- (a) the **Authority** has approved a **profile** for the **unmetered load** that allows the **reconciliation participant** to provide **half hour submission information** to the **reconciliation manager** for the **unmetered load**; and
 - (b) the **reconciliation participant** provides **half hour submission information** in accordance with the **profile**.
- (6) The **half hour submission information** that a **reconciliation participant** submits under subclause (1), subclause (2), or subclause (4) must be **volume information** aggregated to the following levels:
- (a) **NSP code**:
 - (b) **reconciliation type**:
 - (c) **profile**:
 - (d) **loss category code**:
 - (e) flow direction:
 - (f) dedicated **NSP**:
 - (g) **trading period**.
- (7) The non **half hour submission information** that a **reconciliation participant** submits under subclause (2), subclause (3), and subclause (5) must be **volume information** aggregated to the following levels:
- (a) **NSP code**:
 - (b) **reconciliation type**:
 - (c) **profile**:
 - (d) **loss category code**:
 - (e) flow direction:
 - (f) dedicated **NSP**:
 - (g) **consumption period** or day.

Compare: Electricity Governance Rules 2003 clause 3 schedule J3

Clause 8: replaced, on 1 November 2018, by clause 124 of the Electricity Industry Participation Code Amendment (Code Review Programme) 2018.

9 Rounding of submission information

If **submission information** aggregated by a **reconciliation participant** under clause 8 is specified to more than 2 decimal places, the **reconciliation participant** must round the **submission information**—

- (a) to 2 decimal places; and
- (b) so that if the digit to the right of the second decimal place is greater than or equal to 5, the second digit is rounded up, and if the digit to the right of the second decimal place is less than 5, the second digit is unchanged.

Compare: Electricity Governance Rules 2003 clause 3A schedule J3

Clause 9: amended, on 1 February 2016, by clause 104 of the Electricity Industry Participation Code Amendment (Code Review Programme) 2015.

10 Reporting requirements

- (1) By 1600 hours on the 13th **business day** of each **reconciliation period**, each **reconciliation participant** must report to the **reconciliation manager** the proportion of **historical estimates** prepared under clauses 4 or 4A, per **NSP** contained within its non **half hour submission information**.
- (2) By 1200 hours on the last **business day** of each **reconciliation period**, the **reconciliation manager** must provide to the **Authority** a report of the proportion of **historical estimates** prepared under clause 4 or clause 4A, per **NSP** and per **reconciliation participant**, being used to create non **half hour consumption information** in respect of each **consumption period** being reconciled, and the **Authority** must publish the information.
- (3) The proportion of **submission information** per **retailer** per **NSP** that is comprised of **historical estimates** prepared under clause 4 or clause 4A must, unless **exceptional circumstances** exist, be—
 - (a) at least 80% for revised data provided at the month 3 revision; and
 - (b) at least 90% for revised data provided at the month 7 revision; and
 - (c) 100% for revised data provided at the month 14 revision.

Compare: Electricity Governance Rules 2003 clause 4 schedule J3
Clause 10(1), (2) and (3): amended, on 31 December 2021, by clause 72(1), (2) and (3) of the Electricity Industry Participation Code Amendment (Code Review Programme) 2019

11 Distributed unmetered load database

- (1) A **retailer** must ensure that an up-to-date database is maintained for each type of **distributed unmetered load** for which it is responsible. The methodology for deriving **submission information** in the database must comply with Schedule 15.5.
- (2) The database must contain at a minimum—
 - (a) each **ICP identifier** for which the **retailer** is responsible, and to which **distributed unmetered load** is **electrically connected**; and
 - (aa) the item or items of **distributed unmetered load** associated with each **ICP identifier**; and
 - (b) the location of each item; and
 - (c) a description of load type for each item, including any assumptions made in the assessment of its capacity; and
 - (d) the capacity of each item in watts.
- (2A) Each **retailer** must ensure that each item of **distributed unmetered load** for which the **retailer** is responsible is recorded in the database in accordance with this clause.
- (3) The database must track the time of additions and changes in a way that enables the total load in kW to be retrospectively derived for any day.
- (4) The database must incorporate an audit trail of all additions and changes identifying the before and after values for changes, date and time of the change or addition, and the person making the change or addition.
- (5) *[Revoked]*

Compare: Electricity Governance Rules 2003 clause 5 schedule J3
Clause 11(2)(a): amended, on 19 December 2014, by clause 42 of the Electricity Industry Participation Code Amendment (Minor Code Amendments) (No 3) 2014.
Clause 11(2)(a): inserted, on 1 June 2017, by clause 35(1)(a) of the Electricity Industry Participation Code Amendment (Requirements and Processes for Audits) 2016.

Electricity Industry Participation Code 2010
Schedule 15.3

Clause 11(2)(a): amended, on 5 October 2017, by clause 535 of the Electricity Industry Participation Code Amendment (Code Review Programme) 2017.

Clause 11(2)(b): amended, on 1 June 2017, by clause 35(1)(b) of the Electricity Industry Participation Code Amendment (Requirements and Processes for Audits) 2016.

Clause 11(2)(c): amended, on 1 June 2017, by clause 35(1)(c) of the Electricity Industry Participation Code Amendment (Requirements and Processes for Audits) 2016.

Clause 11(2)(d): amended, on 1 June 2017, by clause 35(1)(d) of the Electricity Industry Participation Code Amendment (Requirements and Processes for Audits) 2016.

Clause 11(2A): inserted, on 1 June 2017, by clause 35(2) of the Electricity Industry Participation Code Amendment (Requirements and Processes for Audits) 2016.

Clause 11(5): revoked, on 1 June 2017, by clause 35(3) of the Electricity Industry Participation Code Amendment (Requirements and Processes for Audits) 2016.

Schedule 15.4 Reconciliation procedures

cls 15.19, 15.20 and 15.21

1 Contents of this Schedule

This Schedule relates to the parts of the reconciliation process performed by the **reconciliation manager** during each **reconciliation period** and for relevant **consumption periods** in accordance with the revision cycle. The following steps comprise the reconciliation process. The requirements of each of these steps are detailed in the remainder of this Schedule. The steps are that the **reconciliation manager** must—

- (a) adjust **submission information** by **ICP days** scaling; and
- (b) apply **loss factors** to **submission information** for **half hour** metered **ICPs** that have been adjusted for **ICP days**; and
- (c) **profile** non **half hour submission information** into **trading periods**; and
- (d) apply **loss factors** to **submission information** for non **half hour** metered **ICPs** that have been adjusted for **ICP days**; and
- (e) calculate **unaccounted for electricity** for each **balancing area**; and
- (f) allocate consumed **electricity** and **unaccounted for electricity** to **purchasers**; and
- (g) allocate generated **electricity** to **generators**; and
- (h) produce reports.

Compare: Electricity Governance Rules 2003 clause 1 schedule J4

2 Overview of key reconciliation events

Each **reconciliation participant** must comply with the timing requirements summarised below:

<i>Timing</i>	<i>Reconciliation process</i>	<i>Revisions cycles</i>
Commencement of the 1 st day of the reconciliation period	Beginning of reconciliation period .	Beginning of reconciliation period .
By 1600 hours on the 4th business day of the reconciliation period	The registry manager must make available, and the reconciliation manager must procure, ICP days, loss factor and balancing area and half hour ICP identifiers information, in accordance with clauses 11.24 to 11.27. Each reconciliation participant must submit to the reconciliation manager submission information, retailer information and	

Electricity Industry Participation Code 2010
Schedule 15.4

<i>Timing</i>	<i>Reconciliation process</i>	<i>Revisions cycles</i>
	NSP information, in accordance with clauses 15.4 to 15.12.	
By 1600 hours on the 7 th business day of the reconciliation period	The reconciliation manager must complete a reconciliation of the submission information provided by participants and the grid owner in accordance with this Schedule, and must make reconciliation information available to each reconciliation participant who submitted the submission information to which it relates, and the clearing manager for settlement.	
From the 8 th business day of the reconciliation period	Each reconciliation participant must seek to resolve all inaccuracies and disputes concerning the reconciliation information .	
By 1600 hours on the 13 th business day of the reconciliation period		Each reconciliation participant must submit to the reconciliation manager revised submission information, retailer information and NSP information in accordance with clauses 15.4 to 15.12, 15.27, and 15.28, and clause 10 of Schedule 15.3. The registry manager must make available and the reconciliation manager must procure revised ICP days, loss factor, balancing area and half hour ICP identifiers information, in accordance with clauses 11.24 to 11.27, and clause 10 of Schedule 15.3.

<i>Timing</i>	<i>Reconciliation process</i>	<i>Revisions cycles</i>
By 1200 hours on the last business day of the reconciliation period		The reconciliation manager must distribute revised reconciliation information to the entitled reconciliation participants and the clearing manager , in accordance with clause 28 of this Schedule.

Compare: Electricity Governance Rules 2003 clause 2 schedule J4
Clause 2 Rows 2 and 5 of Table: amended, on 5 October 2017, by clause 536 of the Electricity Industry Participation Code Amendment (Code Review Programme) 2017.

3 Calculation by difference for embedded networks

- (1) A **trader** may by written notice to the **reconciliation manager** designate an **ICP** on an **embedded network** for which the **volume information** is to be calculated by difference.
- (2) A **trader** must give notice under subclause (1) at least 5 **business days** before the designation of the **ICP** takes effect.
- (3) Not more than 1 **ICP** on an **embedded network** may be designated at any time.
- (4) The **reconciliation manager** must calculate the **volume information** by **trading period** for an **ICP** to which a designation relates using the following formula:

$$i - x = a$$

where

- i is the loss adjusted quantity of **electricity** injected into the **embedded network** derived from **NSP** and **submission information**
 - x is the loss adjusted quantity of **electricity** leaving the **embedded network** derived from **NSP** and **submission information**
 - a is the differenced **volume information** for the **ICP** to which the designation relates.
- (5) The **reconciliation manager** must allocate the **volume information** calculated under subclause (4) to the **ICP** to which the designation relates.
 - (6) A **trader** may, by written notice to the **reconciliation manager**, revoke a designation made under subclause (1).

Compare: Electricity Governance Rules 2003 clause 3 schedule J4

4 Calculation by difference for local networks

- (1) A **trader** may apply to the **Authority** for the **Authority** to designate part of a **local network** for which the **volume information** is to be calculated by difference.
- (2) A **trader** must give notice under subclause (1) at least 10 **business days** before the date the **trader** intends the designation to take effect.

- (3) The **trader** must comply with any requirements specified by the **reconciliation manager** within 5 **business days** of receiving notice of the requirements.
- (4) If the **Authority** grants a designation, the **reconciliation manager** must calculate the **volume information** by **trading period** for an **ICP** to which the designation relates using the following formula:

$$i - x = a$$

where

- i is the loss adjusted quantity of **electricity** injected into the **local network** derived from **NSP** and **submission information**
- x is the loss adjusted quantity of **electricity** leaving the **local network** derived from **NSP** and **submission information**
- a is the differenced **volume information** for the **ICP** to which the designation relates.

- (5) The **reconciliation manager** must allocate the **volume information** calculated under subclause (4) to the **trader** who applied for the designation under subclause (1).
- (6) The **Authority** may revoke the approval of a designation granted under subclause (1).

Compare: Electricity Governance Rules 2003 clause 3A schedule J4
Clause 4(3): amended, on 5 October 2017, by clause 537 of the Electricity Industry Participation Code Amendment (Code Review Programme) 2017.

5 ICP days scaling of submission information excluding embedded generation information

ICP scaling must be used to adjust each **retailer's submission information** (excluding **embedded generator** information) by a factor determined by the number of **ICP days** submitted for reconciliation compared to the number of **ICP days** recorded in the **registry**.

Compare: Electricity Governance Rules 2003 clause 4 schedule J4

6 ICP days information

- (1) Each **retailer** and each **direct purchaser** (excluding **direct consumers**) must deliver to the **reconciliation manager**, in accordance with clause 15.6, the number of **half hour** and non **half hour ICP days** for the **NSPs** that are recorded in the **registry** as consuming **electricity** at any time during the relevant **consumption period**, upon which the **retailer's** or **direct purchaser's submission information** is based.
- (2) The **registry manager** must deliver to the **reconciliation manager**, in accordance with clauses 11.24 to 11.27, the number of **half hour** and non **half hour ICP days per NSP** each **retailer** and **direct purchaser** (excluding **direct consumers**) is responsible for during each **consumption period**.

Compare: Electricity Governance Rules 2003 clause 4.1 schedule J4
Clause 6: amended, on 5 October 2017, by clause 538 of the Electricity Industry Participation Code Amendment (Code Review Programme) 2017.

7 ICP scaling factor calculation

- (1) The **reconciliation manager** must, using the **retailer** and **direct purchaser** reported **ICP days** and **registry** reported **ICP days**, calculate **ICP day** scaling factors separately in respect of non **half hour** and **half hour** metered **ICPs** according to the following formula:

$$ICP_{SF} = ICPD_{REG} / ICPD_{RTLRL}$$

where

ICP_{SF} is the **ICP** scaling factor

$ICPD_{REG}$ is the number of **ICP days** for that **retailer** per **balancing area** as reported by the **registry manager**

$ICPD_{RTLRL}$ is the number of **ICP days** for that **retailer** for that **balancing area** as reported by each **retailer**

provided that if—

- (a) the **ICP** scaling factor is calculated to be less than 1, it must, for the purposes of this clause, be deemed to be 1; and
- (b) the **ICP** scaling factor is calculated to be greater than 1, it must not exceed a figure nominated and published from time to time by the **Authority**.
- (2) The **ICP days** scaling factor for **direct consumers** must be 1.
- (3) If the **ICP days** value reported by a **retailer** or a **direct purchaser** in respect of a **balancing area** is 0, or if data is not supplied, but in each case the corresponding **ICP days** value from the **registry manager** is not 0, the **reconciliation manager** must add to that **retailer's submission information** for that **consumption period** an amount (designated $SI_{ICPD-ADD}$) that is equal to—
- (a) 25 kWh per **ICP day**, in respect of non **half hour ICPs**; and
- (b) 40 kWh per **trading period** per **ICP day**, in respect of **half hour ICPs**.
- (4) The relevant number of **ICP days** is the value reported by the **registry manager**.
- (5) The **reconciliation manager** must, when processing 0 **ICP days** information, and if data is not supplied, use default values for **profile**, and **loss category** code, as determined by the **Authority** from time to time.

Compare: Electricity Governance Rules 2003 clause 4.2 schedule J4

Clause 7(1), (3) and (4): amended, on 5 October 2017, by clause 539 of the Electricity Industry Participation Code Amendment (Code Review Programme) 2017.

8 ICP days scaling of submission information (excluding embedded generator information)

- (1) The **reconciliation manager** must separately apply the **ICP** scaling factors and any additional amount calculated in clause 7 to the reported **half hour** and non **half hour** **submission information** (excluding **embedded generator** information) of each **retailer** or **direct purchaser** (excluding **direct consumers**) so as to scale up the

submission information in proportion to any under submission by the **retailer** or **direct purchaser**.

- (2) The **ICP** scaling factor and any amount calculated in accordance with clause 7 must be applied to the **submission information** according to the following formula:

$$SI_{ICPD-ADJ} = (SI \times ICP_{SF}) + SI_{ICPD-ADD}$$

where

$SI_{ICPD-ADJ}$ is **submission information** adjusted for **ICP days**

SI is the amount of **electricity** reported as part of that **retailer's** or **direct purchaser's submission information**

ICP_{SF} is the **ICP** scaling factor determined in accordance with clause 7

$SI_{ICPD-ADD}$ is the default **ICP 0 days** volume defined under clause 7(3).

Compare: Electricity Governance Rules 2003 clause 4.3 schedule J4

9 Calculate residual non half hour profile shape

The **reconciliation manager** must calculate the residual **profile** shape for each **balancing area** in accordance with Schedule 15.5.

Compare: Electricity Governance Rules 2003 clause 5 schedule J4

Convert non half hour quantities using profiles

10 Allocation by profile

If **submission information** is submitted as non **half hour** quantities to be allocated to **trading periods** by **profile** shape, the **reconciliation manager** must use the appropriate shape for the **profile** code contained in the **submission information**, if—

- (a) the **profile** code has been approved by the **Authority** in accordance with Schedule 15.5; and
- (b) the **profile owner** has given written notice to the **reconciliation manager** of the approved **profile** code; and
- (c) the **profile owner** has authorised the **reconciliation participant** to use the approved **profile** code.

Compare: Electricity Governance Rules 2003 clause 6.1 schedule J4

Clause 10(a) and (b): amended, on 5 October 2017, by clause 540 of the Electricity Industry Participation Code Amendment (Code Review Programme) 2017.

11 Profile shapes or operation logs

If an engineered, statistically sampled or recorded **profile** forms part of the **submission information**, the shape file or operation logs associated with the **profile** must be provided to the **reconciliation manager** by the **reconciliation participant** authorised by the **profile owner** to use that **profile** for each relevant **NSP** in respect of the prior **consumption period** in accordance with clauses 15.4 to 15.12.

Compare: Electricity Governance Rules 2003 clause 6.2 schedule J4

12 Application of profile shapes

The **reconciliation manager** must calculate the **trading period** information by applying the **profile** shape for the **profile** code specified in the submission file provided by the **reconciliation participant** if—

- (a) the **profile** code has been approved by the **Authority** in accordance with Schedule 15.5; and
- (b) the **profile owner** has given written notice to the **reconciliation manager** of the approved **profile** code, and the **profile owner** has authorised the **reconciliation participant** to use the approved **profile** code; and
- (c) if a **balancing area** shape is required as part of the **profile**, the initial residual or final residual **profile** shape as defined in Schedule 15.5 must be used.

Compare: Electricity Governance Rules 2003 clause 6.3 schedule J4

Clause 12(a) and (b): amended, on 5 October 2017, by clause 541 of the Electricity Industry Participation Code Amendment (Code Review Programme) 2017.

13 Balancing area derived profiles approved in accordance with Appendix 1 of Schedule 15.5

(1) The **reconciliation manager** must calculate the **trading period** information by applying the **balancing area** derived **profile** code specified in the submission file provided by the **reconciliation participant**, if—

- (a) the **profile** code has been approved by the **Authority** for use as a **balancing area** derived **profile** in accordance with Schedule 15.5; and
- (b) the **profile owner** has given written notice to the **reconciliation manager** of the approved **profile** code, and that the **profile owner** has authorised the **reconciliation participant** to use the approved **profile** code.

(2) If the **Authority** has not approved the **profile** code, or submitted the **profile** to the **reconciliation manager** in accordance with clause 12(1) of Appendix 1 of Schedule 15.5, the **reconciliation manager** must calculate the **trading period** information using the final residual **profile** shape as defined in Schedule 15.5.

Compare: Electricity Governance Rules 2003 clause 6.4 schedule J4

Clause 13(a) and (b): amended, on 5 October 2017, by clause 542(a) and (b) of the Electricity Industry Participation Code Amendment (Code Review Programme) 2017.

Clause 13(c): replaced, on 5 October 2017, by clause 542(c) of the Electricity Industry Participation Code Amendment (Code Review Programme) 2017.

Clause 13: replaced, on 1 March 2024, by clause 123 of the Electricity Industry Participation Code Amendment (Code Review Programme) 2024.

14 Invalid submission information

If invalid **submission information** is submitted, and the **reconciliation manager** cannot obtain corrected information within a reasonable time period from the **reconciliation participant**, the **reconciliation manager** must—

- (a) use the default values specified in this Code (if any); or
- (b) if the default values described in paragraph (a) do not exist, use the default values specified by the **Authority** (if any); or
- (c) if the default values described in paragraph (b) do not exist, temporarily replace the invalid data with an estimate.

Compare: Electricity Governance Rules 2003 clause 6.5 schedule J4

15 Loss factors

- (1) The **Authority** may, from time to time, direct the **reconciliation manager** to apply certain values for **loss factors** for each **loss category** for a **reconciliation period** for which the **registry manager** does not, for whatever reason, provide the **reconciliation manager** with the **loss factors** for each **loss category** in accordance with clause 11.26(b).
- (2) If the **Authority** makes such a direction, the **reconciliation manager** must, after adjustment for **ICP days** scaling and the application of **profiles**, apply such **loss factors** to all **submission information** for all **reconciliation periods** during which the **Authority's** direction is current.
- (3) The **reconciliation manager** must apply **loss factors** to **submission information** in respect of each **embedded network** and **interconnection point**, and **submission information** in respect of parent **networks** for the appropriate **reconciliation period**.

Compare: Electricity Governance Rules 2003 clause 7 schedule J4

Clause 15(1): amended, on 5 October 2017, by clause 543 of the Electricity Industry Participation Code Amendment (Code Review Programme) 2017.

16 Calculation of unaccounted for electricity

- (1) The **reconciliation manager** must calculate the **unaccounted for electricity** for each **balancing area** for each **trading period** in accordance with the following formula after all relevant quantities have been loss adjusted and scaled for **ICP days**:

$$UFE_{BA} = TOT_{BA} - Q_{BA-EN}$$

where

UFE_{BA} is the **unaccounted for electricity** for each **balancing area** for the relevant **trading period**

TOT_{BA} is the net total of all **electricity** injected into the **balancing area** less all **electricity** leaving the **balancing area** as measured at—
(a) the **NSPs** in respect of the **balancing area**; and
(b) the **ICPs** for any **embedded generators electrically connected** to the **balancing area**

Q_{BA-EN} is all **electricity** conveyed to **consumers** connected to the **balancing area**, being the sum of the consumption parts of **submission information**, adjusted for **losses** and **ICP days**.

- (2) The **reconciliation manager** must calculate the **UFE** factor in respect of each **balancing area** for each **trading period** as follows:

$$UFE\ Factor_{BA} = TOT_{BA} / Q_{ICPD-LA}$$

where

$UFE\ Factor_{BA}$ is the **unaccounted for electricity** factor in respect of each **balancing area** for each **trading period**

$Q_{ICPD-LA}$ is all **electricity** conveyed to **consumers** and **embedded networks** connected to the **balancing area**, being the sum of the consumption parts of **submission information**, adjusted for **losses** and **ICP days**

TOT_{BA} has the meaning given to it in subclause (1).

Compare: Electricity Governance Rules 2003 clause 8 schedule J4

Clause 16(1) definition of Q_{BA-EN} : amended, on 15 May 2014, by clause 67(a) of the Electricity Industry Participation (Minor Code Amendments) Code Amendment 2014.

Clause 16(2) definition of $Q_{ICPD-LA}$: amended, on 15 May 2014, by clause 67(b) of the Electricity Industry Participation (Minor Code Amendments) Code Amendment 2014.

Clause 16(1) and (2): amended, on 23 February 2015, by clause 75 of the Electricity Industry Participation Code Amendment (Distributed Generation) 2014.

Clause 16(1) and (2): amended, on 5 October 2017, by clause 544 of the Electricity Industry Participation Code Amendment (Code Review Programme) 2017.

17 Scorecard rating

- (1) The **reconciliation manager** must rate each **retailer** relative to all other **retailers** using a **scorecard rating**. The numerical scores must be determined in accordance with this clause and clause 18 and used to weight the portion of **unaccounted for electricity** to be allocated to each **retailer**.
- (2) Each **retailer** must provide to the **reconciliation manager**, in accordance with clause 15.7, the quantity of **electricity supplied**.
- (3) The **reconciliation manager** must allocate **electricity supplied** quantities, to **reconciliation periods** for reporting and calculation purposes and in the event of unusual circumstances that must have been approved beforehand in writing by the **Authority**, re-allocate quantities on a reasonable basis to reflect the month(s) of actual usage.

Compare: Electricity Governance Rules 2003 clause 9.1 schedule J4

18 Calculation of scorecard rating

- (1) The **reconciliation manager** must calculate, **publish** and apply the **scorecard rating** for each **retailer** as follows:
 - (a) the **scorecard rating** for each **retailer** must be calculated and **published** by the **reconciliation manager** in respect of each **reconciliation period** from which the **reconciliation manager** processes **submission information**, but must only be applied in respect of the 7 and 14 month revisions:
 - (b) the **scorecard rating** for each **retailer** for each **balancing area** (SC_{Ri}) must, subject to subclause (4), be calculated according to the following formula (provided that if the **scorecard rating** is calculated through the application of the formula to be less than 1, then SC_{Ri} is set to 1):

$$SC_{Ri} = AES_{Ri} / (ACI_{Ri} \times SC_{Thres})$$

where

SC_{Ri} SC is the **scorecard rating** and the subscript “Ri” is a **retailer**, for each **consumption period** and each **balancing area**

AES_{Ri} is the sum of the **electricity supplied** quantities for the 12 months up to and including the month of the relevant **consumption period**

ACI_{Ri} is the sum of the **submission information** quantities (**ICP days** adjusted but non **loss** adjusted) for the 12 months up to and including the month before the relevant **consumption period**

SC_{Thres} is the scorecard threshold (that allows for a degree of expected misalignment between the annualised **electricity supplied** and **submission information** quantities) and has the value specified by the **Authority** from time to time:

- (c) in all cases, the latest **electricity supplied** and **submission information** quantities submitted to the **reconciliation manager** by the **retailer** must be used.
- (2) The **scorecard rating** for each **retailer** must be set to 1.25 if the **retailer** has not provided the **reconciliation manager** with any of the required information.
- (3) Despite subclauses (1) and (2), the **scorecard rating** for **direct consumers** and **direct purchasers** must be 1.
- (4) Despite anything else in this Code, the **scorecard rating** must be set to 1 until such time as the **Authority** gives written notice to **participants** that the **scorecard rating** will be calculated and applied in accordance with this clause.

Compare: Electricity Governance Rules 2003 clauses 9.2 and 9.3 schedule J4

Clause 18(1)(b): amended, on 20 December 2021, by clause 73 of the Electricity Industry Participation Code Amendment (Code Review Programme) 2019.

Clause 18(4): amended, on 5 October 2017, by clause 545 of the Electricity Industry Participation Code Amendment (Code Review Programme) 2017.

19 Calculation of unaccounted for electricity

The **reconciliation manager** must apportion **unaccounted for electricity** to each **retailer** and **direct purchaser** at each **NSP** and for each **trading period** using the following formulae:

$$UFE_{Ri} = UFE_{BA} \times AF_{Ri}$$

$$AF_{Ri} = \frac{(SC_{Ri} \times MS_{Ri})}{\text{sum}(SC_{R1} \times MS_{R1}, \dots, SC_{Rn} \times MS_{Rn})}$$

$$MS_{Ri} = Q_{ICPD-LA Ri} / \text{sum}(Q_{ICPD-LA 1}, \dots, Q_{ICPD-LA n})$$

where, for each **trading period**

UFE_{Ri} is the quantity of **unaccounted for electricity** to be allocated to each **retailer** or **direct purchaser**

UFE_{BA} is the quantity of **unaccounted for electricity** for each **balancing area** calculated by the **reconciliation manager** in accordance with clause 16(1)

$Q_{ICPD-LA Ri}$ is the quantity of **electricity** attributed to each **retailer** or **direct purchaser**, which has been adjusted for **losses** and **ICP days** at each **NSP**, determined by the **reconciliation manager** from that **retailer's** or **direct purchaser's submission information**

AF_{Ri} is the **unaccounted for electricity** allocation factor, expressed as a fractional number (not less than 0 or greater than 1), for each **retailer** or **direct purchaser** at each **NSP**, determined by the **reconciliation manager**

MS_{Ri} is the market share proportion, expressed as a fractional number (not less than 0 or greater than 1), for each **retailer** or **direct purchaser** at each **NSP** to be determined by the **reconciliation manager** from all **submission information** at that **NSP**

and, for each **consumption period**

SC_{Ri} is the **scorecard rating** for each **retailer** or **direct purchaser** for each **balancing area** determined by the **reconciliation manager** in accordance with clauses 17 and 18.

Compare: Electricity Governance Rules 2003 clause 10.1 schedule J4

20 Allocation of unaccounted for electricity

The **reconciliation manager** must add each **retailer's** or **direct purchaser's** share of **unaccounted for electricity** to the previously calculated **ICP days** and **loss** adjusted **submission information** at each **NSP** for each **trading period** using the following formula:

$$Q_{ILU Ri} = Q_{ICPD-LA Ri} + UFE_{Ri}$$

where, for each **trading period**

$Q_{ILU Ri}$ is the quantity of **electricity** to be attributed to each **retailer** or **direct purchaser** that has been **ICP days** scaled, and **loss** adjusted and is **UFE** inclusive

$Q_{ICPD-LA Ri}$ and UFE_{Ri} have the meaning given to them in clause 19.

Compare: Electricity Governance Rules 2003 clause 10.2 schedule J4

21 Parent network UFE allocated to embedded networks

A portion of the **UFE** from the **balancing area** to which an **embedded network** is connected must be allocated by the **reconciliation manager** to each **reconciliation participant** trading on the **embedded network**. The quantity of **UFE** to be allocated by the **reconciliation manager** to the **embedded network** must be allocated in

proportion to the ratio of the **embedded network's**, and upstream **balancing area's**, **submission information** quantities (that have been adjusted for **losses** and **ICP days**).

Compare: Electricity Governance Rules 2003 clause 11 schedule J4

Clause 21: amended, on 23 February 2015, by clause 75 of the Electricity Industry Participation Code Amendment (Distributed Generation) 2014.

Clause 21: amended, on 5 October 2017, by clause 546 of the Electricity Industry Participation Code Amendment (Code Review Programme) 2017.

22 Balancing

The **reconciliation manager** must balance the **UFE** inclusive, **ICP days** and loss adjusted **submission information** so that the sum of each **reconciliation participant's** quantities equals each **NSP** metered quantity during each **trading period**. The following process must be used by the **reconciliation manager**:

- (a) for each **retailer** or **direct purchaser**, at each **NSP**, any quantities that have been designated as being attributable to a specific **NSP** within the **balancing area** must be separated off from the remaining non-dedicated quantity and remain allocated to the specific **NSP**. If the sum of each **retailer's** dedicated-**NSP** quantities exceeds the amount of **electricity** conveyed at the **NSP** in any **trading period**, the **NSP** total must be apportioned to the relevant **retailers** or **direct purchasers** in proportion to their dedicated-**NSP** quantities. The net quantities of non-dedicated **electricity** at each **NSP** must be determined by subtracting the dedicated quantities from the **NSP** totals:
- (b) the **NSPs** within a **balancing area** that have been over-allocated **electricity** must be identified by comparing the sum of the non-dedicated quantities for each **retailer** and **direct purchaser** with the net **NSP** quantity. The non-dedicated quantities for each **retailer** and **direct purchaser** at each over-allocated **NSP** must be adjusted in order to achieve balance as follows:

$$Q_{BAL\ NSP_x\ Ri} = \frac{Q_{ILUN\ NSP_x\ Ri} \times TOT_{ND\ NSP_x}}{\text{sum}(Q_{ILUN\ NSP_x\ R1}, \dots, Q_{ILUN\ NSP_x\ Rn})}$$

where

$Q_{BAL\ NSP_x\ Ri}$ is the quantity of fully adjusted, non dedicated **electricity** per **NSP** allocated to each **retailer** and **direct purchaser** after balancing to match the **NSP** total

$Q_{ILUN\ NSP_x\ Ri}$ is the quantity of non-dedicated **electricity** per **NSP** attributed to each **retailer** and **direct purchaser**, which has been adjusted for **losses** and **ICP days**, and is **UFE** inclusive

$TOT_{ND\ NSP_x}$ is the quantity of non-dedicated **electricity** conveyed at the **NSP** (after allowing for relevant **balancing area** injection and extraction quantities):

- (c) the **reconciliation manager** must identify the quantities of **electricity** by which the over-allocated **NSPs** have been reduced, by **retailer** and by **direct purchaser**,

and re-allocate to the corresponding under-allocated **NSPs** within the **balancing area** using the following formulae:

- (i) calculate the previously over-allocated quantity per **retailer** and **direct purchaser** per **balancing area** as follows:

$$Q_{OVER Ri} = \text{sum}(Q_{ILUN NSP1 Ri} - Q_{BAL NSP1 Ri}, \dots, Q_{ILUN NSPn Ri} - Q_{BAL NSPn Ri})$$

where

$Q_{OVER Ri}$ is the sum, over all **NSPs** in the **balancing area** that are over-allocated per **retailer** and **direct purchaser**, of the differences between the pre- and post-adjusted quantities in paragraph (b); and

$Q_{ILUN NSP1 Ri}$ and $Q_{BAL NSP1 Ri}$ have the meaning given to them in paragraph (b):

- (ii) determine the proportions by which the over-allocated quantity must be allocated to the under-allocated **NSPs**, per **retailer** and **direct purchaser**, in order to ensure that the sum of all **reconciliation participants'** totals balance, after re-allocation, to the **NSP** totals as follows:

$$PR_{NSP x} = (\text{TOT}_{ND NSP x} - \text{sum}(Q_{ILUN NSP x R1} \dots Q_{ILUN NSP x Rn})) / Q_{OVER BA}$$

where

$PR_{NSP x}$ is the proportion by which the over-allocated quantity must be allocated to the under-allocated **NSPs**, per **retailer** and **direct purchaser**

$Q_{OVER BA}$ is the sum of all over-allocated quantities for all **retailers** and **direct purchasers** for all over-allocated **NSPs** in the relevant **balancing area**

$\text{TOT}_{ND NSP x}$ and $Q_{ILUN NSP x R1}$ have the meaning given to them in paragraph (b):

- (iii) allocate the over-allocated quantities to each **retailer** and **direct purchaser** at each under-allocated **NSP** as follows:

$$Q_{BAL NSP x Ri} = \frac{Q_{OVER Ri} \times PR_{NSP Rx}}{+ Q_{ILUN NSP x Ri}}$$

where

$Q_{BAL NSP x Ri}$ is the over-allocated quantities of **electricity** attributed to each **retailer** and **direct purchaser** at each under-allocated **NSP**;

$Q_{OVER Ri}$ has the meaning given to it in subparagraph (i)

$Q_{ILUN\ NSP_x\ Ri}$ has the meaning given to it in paragraph (b); and

$PR_{NSP\ Rx}$ has the meaning given to it in subparagraph (ii).

Compare: Electricity Governance Rules 2003 clause 12 schedule J4

Clause 22: amended, on 15 May 2014, by clause 68 of the Electricity Industry Participation (Minor Code Amendments) Code Amendment 2014.

23 Final quantities

The **reconciliation manager** must determine the final quantities of **electricity** to be purchased by each **reconciliation participant** by adding the dedicated and non-dedicated, balanced quantities using the following formula:

$$Q_{TOT\ Ri} = Q_{BAL\ NSP_x\ Ri} + Q_{DED\ Ri}$$

where

$Q_{TOT\ Ri}$ is the final quantity of **electricity** to be purchased by each **reconciliation participant** determined by adding the dedicated and non-dedicated balanced quantities

$Q_{BAL\ NSP_x\ Ri}$ has the meaning given to it in clause 22(c)(iii)

$Q_{DED\ Ri}$ are the quantities of **electricity** to be purchased by each **reconciliation participant** for dedicated quantities.

Compare: Electricity Governance Rules 2003 clause 13 schedule J4

24 Reconciliation manager reporting requirements

The **reconciliation manager** must provide the information specified in clauses 25 to 27 to those **reconciliation participants, participants** and the **Authority** listed in those clauses, in respect of the prior **consumption period**, by 1600 hours on the 7th **business day** of each **reconciliation period**, and in respect of revisions in accordance with clauses 15.27 and 15.28 by 1200 hours on the last **business day** of each **reconciliation period**.

Compare: Electricity Governance Rules 2003 clause 14 schedule J4

25 Retailer and direct purchaser reports

The **reconciliation manager** must make the following reports available to each relevant **retailer** and **direct purchaser** trading on the **network**:

- (a) the **reconciliation manager** must produce 3 reports of the **UFE** factors for each **NSP** per **retailer** and **direct purchaser**, being—
 - (i) 1 report by **trading period**; and
 - (ii) 1 report by **consumption period**; and
 - (iii) 1 report issued monthly in respect of the immediately preceding 12 **consumption periods**:

- (b) the **reconciliation manager** must report to each **retailer** and **direct purchaser** the **retailer's** and **direct purchaser's** own scorecard and market share proportions for each **NSP**:
- (c) the **reconciliation manager** must report the non **half hour** and **half hour ICP days** scaling factor for each **NSP** and each **retailer** and **direct purchaser**:
- (d) the **reconciliation manager** must report to each **retailer** and **direct purchaser** the **retailer's** and **direct purchaser's** monthly totals for **half hour** metered **ICPs** as supplied by that **retailer** and **direct purchaser** in accordance with clause 15.8, for which **submission information** has not been received within the time required by this Code:
- (e) the **reconciliation manager** must report to each **retailer** and **direct purchaser** the **retailer's** and **direct purchaser's** number of **ICP days** for which **submission information** has not been received within the time required by this Code, separately for non **half hour** and **half hour meter** types:
- (f) the **reconciliation manager** must report all **half hourly** metered **ICPs** that have switched **retailer** and **direct purchaser** in the previous 2 months and for which consumption has changed by a percentage determined by the **Authority**.

Compare: Electricity Governance Rules 2003 clause 14.1 schedule J4

26 Distributor reports

The **reconciliation manager** must forward a report to each **distributor** that includes the following information:

- (a) **electricity** traded for each **trader** trading on the **distributor's network**:
- (b) **electricity supplied** information for each **trader** trading on the **distributor's network**:
- (c) **submission information** for each **trader** trading on the **distributor's network**.

Compare: Electricity Governance Rules 2003 clause 14.2 schedule J4

27 Surveillance reports

The **reconciliation manager** must make the following reports available to the **Authority** and all **participants**:

- (a) reports by **retailers** and **direct purchasers** for the total **unaccounted for electricity** for each **NSP**:
- (b) reports by **retailers** of the variation between **electricity supplied** as reported by **retailers** (in accordance with clause 17) and **submission information** submitted for reconciliation by **retailers**, specified for each—
 - (i) **point of connection** to the **grid**; and
 - (ii) **NSP identifier**; and
 - (iii) **balancing area**:
- (c) summary reports of all **half hour** metered connections for which **submission information** has not been received within the time required by this Code:
- (d) summary reports by **retailers** and **direct purchasers** separately for non **half hour** and **half hour**, of all **ICP days** for which **reconciliation information** has not been received within the time required by this Code:

- (e) reports for each **balancing area** for the difference between the daily average non **half hour** kWh submitted by each **retailer** and **direct purchaser** per **NSP**, and the daily average non **half hour** kWh submitted by all **retailers** and **direct purchasers** per **NSP**;
- (f) separate reports for non **half hour** and **half hour submission information** detailing the difference between the quantity of **electricity** in initial and the quantity of **electricity** in each subsequent **submission information** submission for each **NSP** and each **retailer** and **direct purchaser**.

Compare: Electricity Governance Rules 2003 clause 14.3 schedule J4

Clause 27(c): amended, on 23 February 2015, by clause 75 of the Electricity Industry Participation Code Amendment (Distributed Generation) 2014.

Clause 27(c): amended, on 5 October 2017, by clause 547 of the Electricity Industry Participation Code Amendment (Code Review Programme) 2017.

28 Provision of reconciliation information

The **reconciliation manager** must provide the following information to the **clearing manager** and those **participants** listed below, and in the case of paragraph (f), to the **Authority**, in respect of the prior **consumption period**, by 1600 hours on the 7th **business day** of each **reconciliation period**, and in respect of revisions in accordance with clauses 15.27 and 15.28 by 1200 hours on the last **business day** of each **reconciliation period**. These reports must be in the format, and contain the information determined by the **Authority**. The reports are—

- (a) to each **generator** or **purchaser**, the **reconciliation information** applying to that **generator** or **purchaser**, to enable the **generator** or **purchaser** to verify its **reconciliation information**; and
- (b) to each **grid owner**, such information as is required by that **grid owner** to calculate its charges; and
- (c) to the **clearing manager**, the **reconciliation information** (including all amounts derived by the **reconciliation manager** in accordance with clause 20) applying to each **participant** to enable the **clearing manager** to calculate the amounts owing by the **clearing manager** to each **participant** and by each **participant** to the **clearing manager**; and
- (d) to each **retailer** and **direct purchaser**, the calculated daily **seasonal adjustment shape** related to any **point of connection** for which the **retailer** and **direct purchaser** is trading; and
- (e) to each **retailer**, **generator**, and **direct purchaser**, the **reconciliation manager** must **publish half hour profile** shape data for **profiles**; and
- (f) to the **Authority**, the **reconciliation manager** must provide the report prepared by the **reconciliation manager** referred to in clause 10 of Schedule 15.3
- (g) *[Revoked]*.

Clause 28: amended, on 19 January 2017, by clause 17(1) of the Electricity Industry Participation Code Amendment (Extended Reserve) 2016.

Clause 28(c): amended, on 24 March 2015, by clause 27 of the Electricity Industry Participation (Settlement and Prudential Security) Code Amendment 2013.

Clause 28(f): amended, on 19 January 2017, by clause 17(2) of the Electricity Industry Participation Code Amendment (Extended Reserve) 2016.

Clause 28(f): amended, on 21 December 2021, by clause 43(1) of the Electricity Industry Participation Code Amendment (Automatic Under-Frequency Load Shedding Systems) 2021.

Electricity Industry Participation Code 2010
Schedule 15.4

Clause 28(g): inserted, on 19 January 2017, by clause 17(3) of the Electricity Industry Participation Code Amendment (Extended Reserve) 2016.

Clause 28(g): revoked, on 21 December 2021, by clause 43(2) of the Electricity Industry Participation Code Amendment (Automatic Under-Frequency Load Shedding Systems) 2021.

29 *[Revoked]*

Clause 29: inserted, on 19 January 2017, by clause 18 of the Electricity Industry Participation Code Amendment (Extended Reserve) 2016.

Clause 29: revoked, on 21 December 2021, by clause 44 of the Electricity Industry Participation Code Amendment (Automatic Under-Frequency Load Shedding Systems) 2021.

Schedule 15.5 Profile administration

cl 15.19

1 Contents of this Schedule

This Schedule (including the appendices) contains the requirements for the production of **profiles** that must be used for **electricity** trading if a **metering installation** or **unmetered load** meets the eligibility criteria described in this Schedule.

Compare: Electricity Governance Rules 2003 clause 1 schedule J5

2 Departure from requirements

The **Authority** may approve situations that depart from the requirements of this Schedule if it is satisfied that such departure would have minimal adverse effects on each **participant**.

Compare: Electricity Governance Rules 2003 clause 2 schedule J5

Clause 2: amended, on 5 October 2017, by clause 548 of the Electricity Industry Participation Code Amendment (Code Review Programme) 2017.

3 Load switching

If load switching information is required from the operation log of an external control system, such as a **SCADA** or ripple injection control system, the relevant **reconciliation participant** must ensure that the information, for the immediately preceding **consumption period**, is available by 1600 hours on the 4th **business day** of each month.

Compare: Electricity Governance Rules 2003 clause 3.1 schedule J5

4 Non metering information

A **reconciliation participant** using a **profile** must ensure that all non-metering **information**, such as external control equipment operation logs, used in the determination of **profile** data, is archived in accordance with clause 18 of Schedule 15.2.

Compare: Electricity Governance Rules 2003 clause 3.2 schedule J5

Clause 4: amended, on 29 August 2013, by clause 35 of the Electricity Industry Participation (Metering Arrangements) Code Amendment 2011.

5 Profile population

Each **reconciliation participant** who uses a **profile** must keep a current **profile population** list for each month the **profile** is in use. This will form a part of the audit trail of how **profiles** are applied.

Compare: Electricity Governance Rules 2003 clause 3.3 schedule J5

6 Details of profile approved for use

(1) Each **profile owner** must keep a full copy of all of the details of each **profile** approved for use.

(2) The details must be kept in accordance with clause 18 of Schedule 15.2 for **audit** purposes.

Compare: Electricity Governance Rules 2003 clause 3.4 schedule J5

Clause 6(2): amended, on 29 August 2013, by clause 36 of the Electricity Industry Participation (Metering Arrangements) Code Amendment 2011.

7 Multiple meter registers

If a **metering installation** has multiple **meters** or **meters** with multiple registers, a **reconciliation participant** may choose to have each **meter** or **meter** register treated as 1 of the **profiles** described in Appendix 1.

Compare: Electricity Governance Rules 2003 clause 3.5 schedule J5

8 New profiles

Each new **profile** must be developed in accordance with this Schedule.

Compare: Electricity Governance Rules 2003 clause 3.6 schedule J5

9 Accuracy of clocks

External or internal clocks used for switching of **meter** registers must have a time-keeping accuracy of better than 60 seconds per month. The current time indicated by each clock must be checked for accuracy at least once per year, and corrected as necessary.

Compare: Electricity Governance Rules 2003 clause 3.7 schedule J5

10 Subtractive metering

If a **metering installation** includes subtractive metering, each **participant** must derive the appropriate net consumptions.

Compare: Electricity Governance Rules 2003 clause 3.8 schedule J5

11 Change of profile

- (1) A **profile owner** may apply to the **Authority** to change a **profile**.
- (2) An application must contain—
 - (a) the **profile** code for the **profile** to which the proposed change relates; and
 - (b) details of the proposed change.
- (3) The **Authority** must not approve an application unless the **Authority** is satisfied that the requirements in clause 20 (for **NSP** derived **profiles**), and clauses 25 and 27 (for statistically sampled engineered **profiles**), with all necessary modifications, have been met.
- (4) The **Authority** must advise the **profile applicant** if the application has been approved or rejected, or of additional steps that must be completed before the application can be considered, no later than 15 **business days** after receipt of the application.

Compare: Electricity Governance Rules 2003 clause 3A schedule J5

Clause 11: amended, on 5 October 2017, by clause 549 of the Electricity Industry Participation Code Amendment (Code Review Programme) 2017.

12 Approved profile classes

- (1) Approved **profile classes** are described in Appendix 1.
- (2) Each **reconciliation participant** must, with the exception of **profile classes** 1.4 and 1.5, apply to use specific **profiles** within those **profile classes** in accordance with clauses 19 to 34.

Compare: Electricity Governance Rules 2003 clause 4 schedule J5

13 Allocation and storage of profile codes

- (1) The **Authority** must determine the **profile** code for an approved **profile** in accordance with this clause.
- (2) **Profile class** 1.4 and 1.5 each have a single approved **profile** code, being—
 - (a) the **profile** code for the single approved **profile** in **profile class** 1.4 is RPS; and
 - (b) the **profile** code for the single approved **profile** in **profile class** 1.5 is UML.
- (3) **Profile class** 2.5 has 2 approved **profile** codes, being—
 - (a) the **profile** code for the approved **profile** in **profile class** 2.5.1 non **half hour** photovoltaic embedded generation, is PV1; and
 - (b) the **profile** code for the approved **profile** in **profile class** 2.5.2 other non **half hour** embedded generation, is EG1.
- (4) **Profile class** 1.7 has a single approved **profile** being, for differenced load, DFP.
- (5) The **Authority** must **publish** the following information for all approved **profiles** in the following format:

profile reference: the unique reference under which the **profile** is allocated and stored

profile class: refer to Appendix 1

characteristics: type(s) of **meter(s)**: A – None
B – Single register
C – Multi-register
type(s) of load(s) D – Controlled
E – Uncontrolled

description: a brief description of the type of **consumer** or **embedded generator** to whom the **profile** applies.

Compare: Electricity Governance Rules 2003 clause 5 schedule J5

Clause 13(1) and (5): amended, on 5 October 2017, by clause 550 of the Electricity Industry Participation Code Amendment (Code Review Programme) 2017.

14 Calculate residual non half hour profile shapes

The **reconciliation manager** must calculate, **half hour by half hour**, a residual **profile** shape for each **balancing area** that must be used to allocate non **half hour submission information** (after adjustment for **losses** and **ICP days**) to **trading periods** in accordance with clauses 15 to 18.

Compare: Electricity Governance Rules 2003 clause 6 schedule J5

15 Determine total balancing area load

- (1) This calculation determines the total **electricity** consumption inside a **balancing area** by summing all of the injection into a **balancing area** and subtracting the extraction out of the **balancing area**. In this case, injection is defined as **electricity** entering (E_i) the **balancing area** and includes flows from **embedded generators**, or any other **network** (including **embedded networks** or the **grid**). Similarly, extraction is defined as the flows of **electricity** leaving (L_i) the **balancing area**, to other **networks**.
- (2) The process in subclause (1) must be carried out for each **trading period** and for each **balancing area** within which there is non **half hour** metered **electricity** to be reconciled by following the procedure below:

$$TOT_{BA} = \underbrace{(E_{GD} + E_{LN} + E_{EN})}_{\text{Sum of energy flow entering the balancing area}} - \underbrace{(L_{GD} + L_{LN} + L_{EN})}_{\text{Sum of energy flow leaving the balancing area}} + \underbrace{(E_{EG})}_{\text{Sum of generation injection entering the balancing area}}$$

where

TOT_{BA} is the total quantity of **electricity** consumed within the **balancing area**, measured as being the sum of flows injected into the **balancing area** less flows out to any **embedded network** or to another **electrically connected network**

E_{GD} is the quantity of **electricity** entering the **balancing area**, as measured by the **grid NSP metering installation** for the **balancing area**

E_{LN} is the quantity of **electricity**, entering the **balancing area** through an **interconnection point** from another **network**, as measured by the **NSP metering installation** (which has been adjusted for **losses**)

L_{GD} is the quantity of **electricity** leaving the **balancing area**, as measured by the **grid NSP metering installation** for the **balancing area**

E_{EN} is the quantity of **electricity** entering the **balancing area** from an **embedded network**, as measured by the **NSP gateway metering installation** for the **embedded network**

E_{EG} is the quantity of **electricity** entering the **balancing area** from an **embedded generator electrically connected** to the **network**, (which may either be **half hour** or non **half hour** metered), as measured by the **NSP metering installation**

L_{LN} is the quantity of **electricity**, leaving the **balancing area** through an **interconnection point** to another **network**, as measured by the **NSP metering installation** (which has been adjusted for **losses**)

L_{EN} is the quantity of **electricity**, leaving the **balancing area** to an **embedded network**, as measured by the **NSP gateway metering installation** for the **embedded network**.

Compare: Electricity Governance Rules 2003 clause 6.1 schedule J5

Clause 15: amended, on 23 February 2015, by clause 75 of the Electricity Industry Participation Code Amendment (Distributed Generation) 2014.

Clause 15(2): amended, on 5 October 2017, by clause 551 of the Electricity Industry Participation Code Amendment (Code Review Programme) 2017.

16 Calculate total non half hour shape

- (1) Using the total **balancing area** quantities determined in accordance with clause 15 and the **reconciliation participants' half hour submission information** (that has been

adjusted for **losses** and **ICP days**), the **reconciliation manager** must calculate, for each **trading period**, a total **profile** shape representing the aggregated consumption of all non **half hour** metered **electricity** for each **balancing area** by following the procedure below:

$$NHH_{Tot} = \underbrace{TOT_{BA}}_{\text{Sum of HHR metered consumption internal to the network area}} - HHR_M$$

where

- NHH_{Tot} is the total quantity of non **half hour** metered **electricity** consumed in a **balancing area** provided that if the calculated quantity is less than 0, the quantity must, for the purposes of this clause, be deemed to be 0
- TOT_{BA} is the total quantity of **electricity** consumed within the **balancing area**, determined in accordance with clause 15
- HHR_M is the total quantity of consumed **electricity** which is calculated from all **reconciliation participants' half hour submission information** (which has been adjusted for **losses** and **ICP days**).

- (2) The volumes described in subclause (1) must not be **published** and are a process step only.

Compare: Electricity Governance Rules 2003 clause 6.2 schedule J5

17 Calculate initial residual profile shape and seasonal adjustment shape

- (1) Using the resultant NHH_{Tot} quantities from the calculation in clause 16, the **reconciliation manager** must calculate, for each **trading period**, **half hour** by **half hour**, the initial residual **profile** shape for each **balancing area** by following the procedure below:

$$GXP_{\text{Init}} = NHH_{\text{Tot}} - (Pr_{\text{ENG}} + Pr_{\text{STAT}})$$

Sum of independently
shaped, non half hour
profiled consumption
internal to the network area

where

GXP_{Init} is the Initial Residual **Profile**. This is the remaining total quantity of **electricity** for each **half hour** that represents the shape-dependent balance of the non **half hour** consumption within a **balancing area**. This set of values, calculated for each **trading period**, is the initial residual **profile** for each **NSP** within the **balancing area**

NHH_{Tot} is as determined in clause 16

Pr_{ENG} is the quantity of consumed **electricity** for each **trading period** that is in accordance with the approved engineered **profile**, calculated from the **reconciliation participant submission information** adjusted for **ICP days** and after application of **loss factors**

Pr_{STAT} is the quantity of consumed **electricity** for each **trading period** that is in accordance with the approved statistically sampled **profile**, calculated from the **reconciliation participant submission information** adjusted for **ICP days** and after the application of **loss factors**.

- (2) The GXP_{Init} values must be used by the **reconciliation manager** to allocate non **half hour submission information** to **trading periods** for each **reconciliation participant** that uses a **profile** that specifies the use of the initial residual **profile** shape at the **NSP**.
- (3) The **reconciliation manager** must aggregate those **trading period** volumes into daily totals for each **profile** at the **NSP**, and those daily totals must be **published** by the **reconciliation manager** as the **seasonal adjustment shape**.

Compare: Electricity Governance Rules 2003 clause 6.3 schedule J5
Clause 17(2): amended, on 15 May 2014, by clause 69 of the Electricity Industry Participation (Minor Code Amendments) Code Amendment 2014.

18 Calculate final residual profile shape

- (1) Using the resultant GXP_{Init} quantity from the calculation in clause 17, the **reconciliation manager** must calculate, for each **trading period**, the final residual **profile** shape for each **balancing area** by following the procedure below:

$$\text{GXP}_{\text{Res}} = \text{GXP}_{\text{Init}} - (\text{PrSh}_1 + \dots + \text{PrSh}_n)$$

Sum of non half hour
dependently shaped
profiles internal to
network area

where

GXP_{Res} is the Final Residual **Profile** (which is given the code “RPS”). This is the remaining quantity of **electricity** for each **trading period** that represents the shape dependent balance of the non **half hour** load within a **balancing area**. The monthly file of this consumption, calculated for each **trading period**, is the final residual **profile** for each **NSP** within the **balancing area**

GXP_{Init} is as determined in clause 17

PrSh_x is the quantity of consumed **electricity** for each **trading period** which is in accordance with the approved shape dependent **profile** calculated from the **reconciliation participant** loss and **ICP days** adjusted **submission information**.

- (2) The GXP_{Res} values in subclause (1) must be used by the **reconciliation manager** to allocate non **half hour submission information** to **trading periods** for each **reconciliation participant** who uses a **profile** that specifies the use of the residual **half hour** shape at the **NSP**, for each **trading period** of the **reconciliation period**.

Compare: Electricity Governance Rules 2003 clause 6.4 schedule J5
Clause 18(2): amended, on 15 May 2014, by clause 70 of the Electricity Industry Participation (Minor Code Amendments) Code Amendment 2014.

New NSP derived profiles

19 Applications

- (1) An application to introduce a new **NSP** derived **profile** must be submitted to the **Authority**, who must either advise the **profile applicant** of further actions, or must approve or reject the application no later than 15 **business days** after its receipt.
- (2) Each application must contain the following—
- a **profile** description:
 - a suggested **profile** code:
 - a **profile class** in accordance with Appendix 1:
 - the criteria applied by the **profile applicant** to allocate **ICP identifiers** in the **profile**:
 - a description of the methodology for compiling **submission information** and **profile** shapes:

- (f) details of dynamics derived from sources external to the **metering installation** (including without limitation **SCADA** and ripple control) if appropriate.

Compare: Electricity Governance Rules 2003 clause 7.1 schedule J5
Clause 19(1): amended, on 5 October 2017, by clause 552 of the Electricity Industry Participation Code Amendment (Code Review Programme) 2017.

20 Assessment

Before approving a **profile**, the **Authority** must be satisfied that—

- (a) there are clear criteria applied by the **reconciliation participant** to allocate **ICP identifiers** in the **profile**; and
- (b) there are no obvious flaws in the methodology for compiling **submission information** and **profile shapes**; and
- (c) the **reconciliation manager** is able to incorporate the **profile** into the reconciliation process; and
- (d) the proposed **profile** is not at variance with existing **profiles** for like populations.

Compare: Electricity Governance Rules 2003 clause 7.2 schedule J5
Clause 20: amended, on 5 October 2017, by clause 553 of the Electricity Industry Participation Code Amendment (Code Review Programme) 2017.

21 Ownership

For the purposes of this Schedule, a **profile applicant** must become the **profile owner** once the application is approved. If the **profile applicant** is not a legal entity, a legal entity must be nominated by the **profile applicant** to be the **profile owner**.

Compare: Electricity Governance Rules 2003 clause 7.3 schedule J5

22 Withdrawal of applications

If an application is withdrawn by a **profile applicant** at any time following the **declaration date**, but before approval, the **Authority** must advise all **participants**.

Compare: Electricity Governance Rules 2003 clause 7.4 schedule J5
Clause 22: amended, on 5 October 2017, by clause 554 of the Electricity Industry Participation Code Amendment (Code Review Programme) 2017.

23 Rejected applications

If an application is rejected, the **Authority** must provide to the **profile applicant** a detailed explanation of why the application was rejected, together with actions required for a reconsideration of the application.

Compare: Electricity Governance Rules 2003 clause 7.5 schedule J5
Clause 23: amended, on 5 October 2017, by clause 555 of the Electricity Industry Participation Code Amendment (Code Review Programme) 2017.

24 Use of approved profiles

- (1) A **profile** must not be used for reconciliation until it is approved by the **Authority** in accordance with clauses 19 and 20. The use of a **profile** must be effective from a date decided by the **Authority**, but not earlier than the 1st day of the month following the **declaration date**.
- (2) A **reconciliation participant** who wishes to reconcile its **ICP identifiers** using an existing **profile** must first gain the approval of the **profile owner**.

Compare: Electricity Governance Rules 2003 clause 7.6 schedule J5

Clause 24(1): amended, on 5 October 2017, by clause 556 of the Electricity Industry Participation Code Amendment (Code Review Programme) 2017.

New statistically sampled/engineered profiles

25 Technical requirements

A new **profile** must be based on a process of statistical sampling carried out in accordance with the guidelines contained in the appendices to this Schedule, or derived using recognised engineering principles, or derived from **NSP profiles**.

Compare: Electricity Governance Rules 2003 clause 8.1 schedule J5

26 Applications

- (1) An application to introduce a new **profile** must be submitted to the **Authority**, who must either advise the **profile applicant** of further actions, or approve or reject the application in writing no later than 15 **business days** after its receipt. Each application must contain the following:
- (a) a **profile** description;
 - (b) a suggested **profile** code;
 - (c) a **profile class** in accordance with Appendix 1;
 - (d) the size of the **profile population** and a list that uniquely identifies each member of the **profile population**;
 - (e) the criteria applied by the **reconciliation participant** to allocate **ICP identifiers** to the **profile**;
 - (f) a description of the methodology for compiling **submission information** and **profile shapes**;
 - (g) details of dynamics derived from sources external to the **metering installation** (including without limitation **SCADA** and ripple control) if appropriate;
 - (h) details of any **half-hour metering** as a control or source of input data to the **profile**;
 - (i) statistical or engineering data that supports the proposed **profile** shape.
- (2) The **profile applicant** must supply any analytical information relating to the application in the format required by the **Authority**.

Compare: Electricity Governance Rules 2003 clauses 8.2 and 8.2A schedule J5

Clause 26(1) and (2): amended, on 5 October 2017, by clause 557 of the Electricity Industry Participation Code Amendment (Code Review Programme) 2017.

27 Assessment

The **Authority** must be satisfied that—

- (a) there are clear criteria applied by the **reconciliation participant** to allocate **profiles** to **ICP identifiers**; and
- (b) there is an audit trail for the allocation of **profiles** to **ICP identifiers**; and
- (c) there are no obvious flaws in the methodology for allocating **profiles** to **ICP identifiers**; and
- (d) the **reconciliation manager** is able to incorporate the **profile** into the reconciliation process; and
- (e) the proposed **profile** is not at variance with existing **profiles** for like populations.

Compare: Electricity Governance Rules 2003 clause 8.3 schedule J5
Clause 27: amended, on 5 October 2017, by clause 558 of the Electricity Industry Participation Code Amendment (Code Review Programme) 2017.

28 Sampling requirements

- (1) Statistical samples must be drawn using the methodology described in Appendix 2. Sampling information must be taken from **fully certified metering installations**.
- (2) For **profiles** that require statistical sampling, the **Authority** must specify the **preliminary sample size** and draw a **preliminary sample** of **ICP identifiers** from the **profile population** list, or must accept appropriate sampling performed by the **profile applicant**. **Half hour** research meters must be, or must have been, installed and operated by the **profile applicant** for this **preliminary sample**. The **Authority** must require a minimum sampling period of 60 days, and not more than 12 months. The **Authority** may withdraw **ICP identifiers** from the **profile population** list if it can be shown by the **profile applicant** that those **ICP identifiers** are in sites that are difficult to meter.
- (3) The average **unit cost** and standard deviation of the **unit cost** must be calculated using the 60 days or more of data obtained as described above. If the sample **co-efficient of variation** is less than or equal to the **profile acceptance limit** specified in Appendix 2, the size of the **profile sample** must be the **profile sample size**. The **Authority** must provide a standard set of synthetic price scenarios to determine the variability of **unit costs**.
- (4) If the sample **co-efficient of variation** is more than the **profile acceptance limit**, the **Authority** can reject the application, or can require the **profile applicant** to supply additional information until the **Authority** is satisfied that there is no clear evidence to suggest the population **co-efficient of variation** exceeds the **profile acceptance limit**.
- (5) If the **preliminary sample size** is less than the **profile sample size**, the **Authority** must draw an additional random sample. The size of the additional random sample must equal the shortfall.
- (6) If the **profile sample size** is less than the **preliminary sample size**, the **preliminary sample** must become the **profile sample**.

Compare: Electricity Governance Rules 2003 clause 8.4 schedule J5
Clause 28(1): amended, on 29 August 2013, by clause 37 of the Electricity Industry Participation (Metering Arrangements) Code Amendment 2011.
Clause 28(1): amended, on 20 December 2021, by clause 75 of the Electricity Industry Participation Code Amendment (Code Review Programme) 2019.
Clause 28: amended, on 5 October 2017, by clause 559 of the Electricity Industry Participation Code Amendment (Code Review Programme) 2017.

29 Ownership

For the purposes of this Schedule, a **profile applicant** must become the **profile owner** once the application is approved. If the **profile applicant** is not a legal entity, a legal entity must be nominated to be the **profile owner**.

Compare: Electricity Governance Rules 2003 clause 8.5 schedule J5

30 Withdrawal of applications

If an application is withdrawn by a **profile applicant** at any time following the **declaration date**, but before approval, the **Authority** must advise all **participants**.

Compare: Electricity Governance Rules 2003 clause 8.6 schedule J5
Clause 30: amended, on 5 October 2017, by clause 560 of the Electricity Industry Participation Code Amendment (Code Review Programme) 2017.

31 Rejected applications

- (1) If an application is rejected, the **Authority** must provide the **profile applicant** with a detailed explanation of why the application was rejected, together with actions required for a reconsideration of the application.
- (2) If an application is rejected because the **coefficient of variation** is found to be too large, the **profile applicant** may resubmit the application with a refined **profile population**.
- (3) The refined **profile population** must be a subset of the original population and must be made up of **ICP identifiers** that are more homogenous in their **unit costs** than those in the original **profile population**.
- (4) Data collected from **half-hour metering** in the original preliminary sample may be re-used to constitute the refined **preliminary sample** as long as the data was collected from **ICP identifiers** that belong to the refined **profile population**.
- (5) The **Authority** must determine if additional **ICP identifiers** are required to make up the refined **preliminary sample**.

Compare: Electricity Governance Rules 2003 clause 8.7 schedule J5
Clause 31(1) and (5): amended, on 5 October 2017, by clause 561 of the Electricity Industry Participation Code Amendment (Code Review Programme) 2017.

32 Use of approved profiles

- (1) A **profile** must not be used for reconciliation until the **Authority** approves it. The use of a **profile** must be effective from a date decided by the **Authority**, but not earlier than the 1st day of the month following the **declaration date**. If an approved **profile** is used for reconciliation, every **ICP identifier** on the **profile population** list must be reconciled under that **profile**.
- (2) A **reconciliation participant** who wishes to reconcile its eligible **ICP identifiers** using an existing **profile** must first gain the approval of the **profile owner**. **ICP identifiers** not already on the **profile population** list must be added to the list before the **profile** can be applied.

Compare: Electricity Governance Rules 2003 clause 8.8 schedule J5
Clause 32(1): amended, on 5 October 2017, by clause 562 of the Electricity Industry Participation Code Amendment (Code Review Programme) 2017.

33 Profile maintenance and changes

- (1) The **profile sample** must be representative of the **profile population**. The **profile owner** must be responsible for maintaining a valid statistical sample which takes into account changes in the **profile population**.
- (2) The **profile owner** must maintain a current **profile population** list. The **profile owner** must inform the **Authority** when an update is necessary (refer subclause (3)). The **profile population** list is subject to random **audit** by the **Authority** or its appointed **audit agent**.
- (3) The **profile sample** must be updated when membership of the **profile population** has changed by more than 20% since the **sample date**. The **profile owner** must, no later than 10 **business days** after the **profile owner** becomes aware of such change in

membership, give written notice to the **Authority** of the changes in the **profile population** list. The **Authority** must determine, and give written notice to the **profile owner** of, any required modifications to the **profile sample**. The **profile owner** has 1 month from the date on which the **profile owner** receives the notice from the **Authority** to ensure that **certified half hour meters** are installed in the **metering installations** of these **ICP identifiers**, and that the **metering installations** are fully **certified**.

- (4) If more than 5% of the **profile sample** has been lost or removed, the **profile owner** must submit to the **Authority** a list of **ICP identifiers** in the current **profile sample** who have been lost or removed from the **profile population** list. The **Authority** must draw **ICP identifiers** from the **profile population** list to replace those who are lost or removed from the **profile sample**. The **profile owner** must ensure that **certified half hour meters** are installed in the **metering installations** of these **ICP identifiers**, and that the **metering installations** are fully **certified**, no later than 1 month after the **Authority** issues its determination of the appropriate replacement **ICP identifiers**.
- (5) The addition or removal of **ICP identifiers** to or from the **profile sample** must follow the procedures in Appendix 2.
- (6) There must be at least 3 months between updates.

Compare: Electricity Governance Rules 2003 clauses 8.9.1 and 8.9.2 schedule J5
Clause 33(2) to (4): amended, on 5 October 2017, by clause 563 of the Electricity Industry Participation Code Amendment (Code Review Programme) 2017.

34 Exceptions to sampling methodology

The **Authority** may allow different sampling methodologies that are not described in this Schedule, only if—

- (a) the methodology can, in the **Authority's** assessment, produce sample data that meets the precision standards specified under Appendix 2; and
- (b) the **Authority** or its **audit** agent is satisfied that the methodology can be **audited** to the same degree of rigour as the sampling methodology outlined in Appendix 2; and
- (c) following the **declaration date** but before approval, details of the shape of the proposed **profile** must be provided by the **profile owner** on a monthly basis to all **participants** trading on the affected **NSP(s)**. Use of such **profile** information is subject to clause 32. Following approval, such details must be provided to all **participants** by the **reconciliation manager**.

Compare: Electricity Governance Rules 2003 clause 8.9.3 schedule J5
Clause 34: amended, on 5 October 2017, by clause 564 of the Electricity Industry Participation Code Amendment (Code Review Programme) 2017.

35 Audits

- (1) A **participant** may request the selective **audit** of any **participant's** compliance with this Schedule or the **participant's** application and use of any **profile**.
- (2) The **Authority** or its agent must **audit** the application of all **profiles** in a random order at least once every 2 years by applying a selection process that the **Authority** determines.
- (3) As a minimum, a **profile audit** must cover the following:
 - (a) the documents detailing the methodology of the **profile**:

- (b) the application of dynamic and estimated elements of the **profile**;
- (c) the **profile population** list.

Compare: Electricity Governance Rules 2003 clause 9 schedule J5
Clause 35(2): replaced, on 5 October 2017, by clause 565 of the Electricity Industry Participation Code Amendment (Code Review Programme) 2017.

36 Reviews

- (1) The **Authority** must review the structure of every approved **profile** at least every 3 years.
- (2) Each review must determine whether—
 - (a) the criteria for **profile** definition are still appropriate; and
 - (b) if applicable, the existing sample needs to be redrawn.

Compare: Electricity Governance Rules 2003 clause 10 schedule J5
Clause 36(1): amended, on 5 October 2017, by clause 566 of the Electricity Industry Participation Code Amendment (Code Review Programme) 2017.

37 Removal of profiles

- (1) If a **profile** fails an **audit**, the **Authority** must remove the **profile** from the list of approved **profiles** held by the **Authority** unless—
 - (a) either—
 - (i) in the case of an **audit** performed by the **Authority**, the **participant** and the **Authority** agree corrective actions no later than 5 **business days** after the date the **audit** is completed; or
 - (ii) in the case of an **audit** performed by the **Authority's** appointed **audit** agent, the **participant**, the **Authority**, and the **audit** agent agree corrective actions no later than 5 **business days** after the date the **audit** is submitted to the **Authority**; and
 - (b) the **Authority** is satisfied that the agreed corrective actions have been performed no later than 3 months after the date the **audit** was completed.
- (1A) Despite subclause (1), the **Authority** must immediately remove a **profile** that fails an **audit** if the **participant** advises the **Authority** that the **participant** will not agree to or perform the corrective actions.
- (2) A **participant** who includes in a **profile** an **ICP identifier** that is not of the classification contained in the **profile** documentation breaches this Code. All alleged breaches must be reported to the **Authority** and resolved in accordance with the **Act**.
- (3) The **Authority** may remove a **profile**—
 - (a) at the request of the **profile owner** that introduced the **profile**; or
 - (b) for such other reasons that the **Authority** decides.
- (4) A **profile owner** that makes a request to the **Authority** under subclause (3)(a) must—
 - (a) make the request in writing; and
 - (b) request the **profile's** removal be effective from the start of the **reconciliation period** immediately following the date on which the **Authority** receives the request.
- (5) If the **Authority** removes a **profile**, the **Authority** must decide on the actions to be taken with respect to the **ICP identifiers** to which the **profile** applied.

Compare: Electricity Governance Rules 2003 clause 11 schedule J5
Clause 37(1): amended, on 5 October 2017, by clause 567(a) of the Electricity Industry Participation Code Amendment (Code Review Programme) 2017.

Electricity Industry Participation Code 2010
Schedule 15.5

Clause 37(3) to (5): replaced, on 5 October 2017, by clause 567(b) of the Electricity Industry Participation Code Amendment (Code Review Programme) 2017.

Clause 37(1): replaced, on 1 March 2024, by clause 124(1) of the Electricity Industry Participation Code Amendment (Code Review Programme) 2024.

Clause 37(1A): inserted, on 1 March 2024, by clause 124(2) of the Electricity Industry Participation Code Amendment (Code Review Programme) 2024.

Appendix 1 Profile classes

1 Contents of this Appendix

This Appendix contains generic descriptions of **metering installations** to which particular **profile classes** may be assigned.

Compare: Electricity Governance Rules 2003 appendix 1 schedule J5

Participants NSP-derived profiles

2 Profile class 1.1 interval time of use meters

(1) **Meters** in the **profile class 1.1** – interval time of use meter classification include the following:

- (a) day-night two rate **meters**:
- (b) night only **meters**:
- (c) night only plus afternoon boost **meters**:
- (d) 5 rate time of use **meters**.

(2) If register-switching is triggered by an external signal, such as a ripple relay, rather than by the **meter's** internal clock, data from the operation log of the equipment controlling the external signal must be used to provide the **profile** time period.

Compare: Electricity Governance Rules 2003 clause 1.1 appendix 1 schedule J5

3 Profile class 1.2 separately metered controlled load

(1) **Meters** in the **profile class 1.2** separately metered controlled load classification include a separate **meter** for a ripple controlled water heater, which may be switched on and off at variable times of the day. The entire load recorded on this register must be available for control.

(2) Information from the operation logs of equipment controlling the connection of controllable loads must be used to determine the time period relating to them. If the controllable load component is not static, a calculation of the diversity of the load must be documented and applied.

(3) Other **meters** in the **metering installation** must be applied as per **profile class 1.1** or 1.4, as appropriate.

Compare: Electricity Governance Rules 2003 clause 1.2 appendix 1 schedule J5

Clause 3(2): amended, on 23 February 2015, by clause 75 of the Electricity Industry Participation Code Amendment (Distributed Generation) 2014.

Clause 3(2): amended, on 5 October 2017, by clause 568 of the Electricity Industry Participation Code Amendment (Code Review Programme) 2017.

4 Profile class 1.3 non separately metered controlled load

(1) Installations in the **profile class 1.3** classification non separately metered controlled load include a ripple controlled water heater but with only 1 **meter** measuring the whole installation including the water heater.

- (2) The controlled load may be switched on and off at variable times of the day. In this case a proportion of the **profile** (kWh) must be applied as per **profile class 1.2** with the remaining kWh applied as per **profile class 1.1** or **1.4**, as appropriate.

Compare: Electricity Governance Rules 2003 clause 1.3 appendix 1 schedule J5

5 Profile class 1.4 uncontrolled load 24 hour meters

- (1) The **profile** from **meters** in the **profile class 1.4** uncontrolled load 24 hour **meters** must follow the **NSP** residual **profile**.
- (2) The **NSP** residual **profile** must be calculated in accordance with clauses 14 to 18 of Schedule 15.5.

Compare: Electricity Governance Rules 2003 clause 1.4 appendix 1 schedule J5

6 Profile class 1.5 unmetered loads

- (1) **Unmetered loads** in the **profile class 1.5** classification include, but are not limited to, under veranda lighting, electric fences, sewer pumps, advertising hoardings, public conveniences, supply to construction sites, electric parking meters, and public water fountains.
- (2) For those types of **unmetered load**, a fixed annual kWh quantity must be assigned to each **ICP** and must be applied according to the 24 hour **NSP** final residual **profile**.

Compare: Electricity Governance Rules 2003 clause 1.5 appendix 1 schedule J5

7 Profile class 1.7 differenced load

Profile class 1.7 differenced load represents the result of subtractive processes performed by the **reconciliation manager** to form differenced load.

Compare: Electricity Governance Rules 2003 clause 1.7 appendix 1 schedule J5

Statistically sampled and engineering profile classes

8 Profile class 2.1 unmetered loads

- (1) **Profiles** may be applied to intended loads with characteristics that are reasonably predictable using time and other observable values.
- (2) The elements making up each load and time period must be documented by the **profile owner**.
- (3) The documentation must include a description of the methodology, formula, and the results of any calculations for any estimated data.

Compare: Electricity Governance Rules 2003 clause 2.1 appendix 1 schedule J5

9 Profile class 2.2 half hour data, metering installations with interim certification

- (1) **Half hour** data from **interim certified metering installations** may be—
- (a) regarded as a 100% sampled **profile** until the expiry of the interim exemption validity period for those **metering installations** under Part 10. From that date, if the **metering installation** has not been **recertified** as a fully **certified metering installation** under Part 10, the **metering installation** must be assigned to **profile class 1.4**; or

- (b) treated as if it was derived from **fully certified metering installations** until the expiry of the interim exemption validity period for those **metering installations**. To avoid doubt, the **half hour** data must be derived from an **interrogation** of the **metering installation** and must be submitted to the **reconciliation manager** in accordance with Schedule 15.4.
- (2) For a 100% sampled **profile**, a method of calculating **forward estimates** must be adopted in accordance with clauses 2 to 7 of Schedule 15.3. A **profile** shape for the **reconciliation period** must be submitted to the **reconciliation manager** with the estimated data.
- (3) If the gathering, validation and repair of **volume information** from an **interim certified metering installation** is carried out in a manner that is not in accordance with Schedule 15.2, these processes must be fully documented in the quality procedures of the **participant**.

Compare: Electricity Governance Rules 2003 clause 2.2 appendix 1 schedule J5

Clause 9(1): amended, on 29 August 2013, by clause 38(a) of the Electricity Industry Participation (Metering Arrangements) Code Amendment 2011.

Clause 9(1)(a): amended, on 29 August 2013, by clause 38(b) and (c) of the Electricity Industry Participation (Metering Arrangements) Code Amendment 2011.

Clause 9(1)(b): amended, on 29 August 2013, by clause 38(d), (e) and (f) of the Electricity Industry Participation (Metering Arrangements) Code Amendment 2011.

Clause 9(3): amended, on 29 August 2013, by clause 38(g) of the Electricity Industry Participation (Metering Arrangements) Code Amendment 2011.

10 Profile class 2.3 unmetered installations that require shape file to be submitted

- (1) A **profile** may be applied to an intended load with characteristics that are reasonably predictable using time and other observable values.
- (2) For those types of **unmetered load**, the **profile** must include a process for maintaining **unmetered load** quantities that are used in the reconciliation process. The shape file will be produced by the **profile owner** from a **metering installation**.
- (3) The elements making up each load and time period must be documented by the **profile owner**. The documentation must include a description of the methodology, formula, and the results of any calculations for any estimated data.

Compare: Electricity Governance Rules 2003 clause 2.3 appendix 1 schedule J5

11 Profile class 2.4 metered installations that require shape file

- (1) A **profile** may be applied to an intended load with characteristics that are reasonably predictable using time and other observable values.
- (2) For those types of metered load, a **metering installation** must be used to determine the quantity of **electricity** for reconciliation purposes.
- (3) The elements making up each load and time period must be documented by the **profile owner**. The documentation must include a description of the methodology, formula, and the results of any calculations for any estimated data.

Compare: Electricity Governance Rules 2003 clause 2.4 appendix 1 schedule J5

12 Profile class 2.5, non half hour embedded generation

- (1) The **Authority** must—
- (a) determine how each of the 2 types of non **half hour embedded generator profiles** under subclause (2) applies and operates; and

- (b) having made its determination under paragraph (a), submit each non **half hour embedded generator profile** to the **reconciliation manager**.
- (2) The 2 types of **non half hour embedded generator profiles** are:
 - (a) the photovoltaic is a time limited **profile** and may only be used for photovoltaic generation that injects **electricity** into the **network** during daylight hours; and
 - (b) the other **profile** is a non limited flat load **profile** and must be used for all other embedded generation that does not fit within the **profile** in paragraph (a) or if the **reconciliation participant** has not created an engineered **profile** for the **embedded generator**.

Compare: Electricity Governance Rules 2003 clause 2.5 appendix 1 schedule J5
Clause 12(1): replaced, on 5 October 2017, by clause 569 of the Electricity Industry Participation Code Amendment (Code Review Programme) 2017.

Appendix 2

Determining statistically sampled profiles

1 Basic sampling scheme

The method of simple random sampling without replacement must be used in drawing statistical samples whenever such samples are required for **profiles** under this Code.

Compare: Electricity Governance Rules 2003 clause 1 appendix 3 schedule J5

2 Preliminary sample

- (1) Unless the **profile applicant** has better information available that is acceptable to the **Authority**, the size of the **preliminary sample** must be determined by the following **preliminary sample size** formula:

$$n_1 = (z_{\alpha}^2 \times C_A^2) / r^2$$

- (2) If n_1/N is greater than 0.1, it must be modified to account for the finite population correction factor and is calculated as—

$$n_1' = n_1 / (1 + n_1/N)$$

- (3) If either n_1 or n_1' is less than 20, the **preliminary sample size** must be 20.

- (4) In the above formula—

N is the size of the **profile population**

α is the confidence level

z_{α} is the value of the standard normal distribution which gives α probability outside the tails

C_A is the value of **co-efficient of variation** of the **unit cost**

r is the **relative standard error** of the **unit cost**.

- (5) The following parameter values are to be used:

Value of **co-efficient of variation** (C_A): 0.1

Relative standard error (r): 0.05

Confidence level (α): 0.99

- (6) The **profile acceptance limit** must be 0.2.

- (7) These values must be subject to review in accordance with clause 5.

- (8) The **profile applicant** must collect **half hour** data from the **preliminary sample** over a period of at least 60 days. The data, in its processed form, must be submitted to the

Authority for consideration. The data processing must include calculations of **unit costs**, and of mean and standard deviation of **unit costs**, over the sample period.

Compare: Electricity Governance Rules 2003 clause 2 appendix 3 schedule J5

Clause 2: amended, on 5 October 2017, by clause 570 of the Electricity Industry Participation Code Amendment (Code Review Programme) 2017.

3 Profile sample

- (1) The size of the **profile sample** must be determined by the following **profile sample size** formula:

$$n = (S_0^2/Y_0^2) \times (z_\alpha^2/r^2) \times \{1 + 8 \times (r^2/z_\alpha^2) \times [S_0^2/(n_1 \times Y_0^2)] + 2/n_1\}$$

- (2) If n/N is greater than 0.1, it must be modified to account for the finite **profile population** correction factor and is calculated as—

$$n' = n/(1+n/N)$$

- (3) If either n or n' is less than n_1 , the **preliminary sample** must become the **profile sample**.
(4) In the above formula—

S_0 is the estimated standard deviation of **unit costs** from the **preliminary sample**, or from the existing **profile sample** in the case of updates

Y_0 is the estimated mean of **unit costs** from the **preliminary sample**, or from the existing **profile sample** in the case of updates

α is the confidence level

z_α is the value of the standard normal distribution which gives α probability outside the tails

n_1 is the size of the **preliminary sample**, or the existing **profile sample** in the case of updates

r is the **relative standard error** of the **unit cost**.

- (5) The **relative standard error** (r) and the confidence level (α) must be the same as those specified in clause 2.
(6) If the size of the **profile sample** is larger than the size of the **preliminary sample**, additional **ICP identifiers** from the **profile population** must be drawn to increase the sample size to the required level.
(7) Data from the **profile sample** must be used to form the basis for future updates.

Compare: Electricity Governance Rules 2003 clause 3 appendix 3 schedule J5

4 Sample updates

- (1) If an update is required because of a change in the **profile population**, the following procedures must be followed:
 - (a) if the size of the updated **profile sample** is larger than the size of the existing **profile sample**, additional **ICP identifiers** must be drawn from new **participants** of the **profile population** to increase the sample size to the required level:
 - (b) if the size of the updated **profile sample** is smaller than the size of the existing **profile sample**, **ICP identifiers** from the existing **profile sample** must be removed to decrease the sample size to the required level, unless the **profile applicant** decides to nominate the existing **profile sample** as the **profile sample**.
- (2) For the purposes of updates, data from the existing **profile sample** must be used (instead of data from the **preliminary sample**) in all **profile sample size** calculations.
Compare: Electricity Governance Rules 2003 clause 4 appendix 3 schedule J5

5 Reviews

- (1) The statistical parameters must be monitored by the **Authority** and reviewed when the **Authority** considers it appropriate. Modifications of those parameters are expected as the industry gains experience in the use of statistical **profiles**. Industry **participants** will be consulted as part of the review process.
- (2) Each year the **Authority** must review data gathered during the year for each **profile sample**, and must re-examine the **co-efficient of variation** and the sample size. A **relative standard error** of 5% and a confidence level of 99% must be applied initially. A figure of 2% for the **relative standard error** is expected to be adopted by the **Authority** following the first 12-monthly review and may thereafter be reviewed from time to time.
- (3) Reviews of existing standards must take place in the 6th month and the 12th month during the 1st year of **profile** introduction.
Compare: Electricity Governance Rules 2003 clause 5 appendix 3 schedule J5
Clause 5(1) and (2): amended, on 5 October 2017, by clause 571 of the Electricity Industry Participation Code Amendment (Code Review Programme) 2017.

Electricity Industry Participation Code 2010

Part 16

Special provisions relating to Rio Tinto agreements

[Revoked]

Part 16: revoked, on 16 December 2013, by clause 10 of the Electricity Industry Participation (Revocation of Part 16) Code Amendment 2013

Electricity Industry Participation Code 2010

Part 16A Audits

Contents

16A.1	Contents of this Part
16A.2	Purpose of this Part
	Subpart 1—Conduct of audits generally
16A.3	Auditors
16A.4	Participants to give access
16A.5	Approval of auditors by the Authority
16A.6	Expiry and cancellation of approval
16A.7	Requirement to appoint new auditor
16A.8	Combined audits
16A.9	Authority may specify emphasis or scope of audit
16A.10	Agent audits
16A.11	Audit required if participant makes material change
16A.12	Process for completion of audits
16A.13	Participants to give final audit report and compliance plan to the Authority
16A.14	Authority to make determination as to next audit date
16A.14A	Authority may require participant to undertake audit
16A.15	Authority to publish information
16A.16	Costs of audits
	Subpart 2—Metering equipment provider audits
16A.17	Time frame for metering equipment provider audits
16A.18	Additional requirements for metering equipment provider audits
	Subpart 3—ATH audits
16A.19	Time frame for ATH audits
16A.20	Additional requirements for class B ATH audits
16A.21	Incorporation of NZ/AS ISO 17025 by reference
	Subpart 4—Distributor audits
16A.22	Time frame for distributor audits
16A.23	Additional requirements for distributor audits
	Subpart 5—Reconciliation participant audits
16A.24	Time frame for reconciliation participant audits
	Subpart 6—Dispatchable load purchaser audits
16A.25	Time frame for dispatchable load purchaser audits
	Subpart 6A—Generator audits
16A.25A	Time frame for generator audits
	Subpart 7—Distributed unmetered load audits
16A.26	Time frame for distributed unmetered load audits
	Subpart 8—Transitional provisions
16A.27	Metering equipment provider audits
16A.28	AHT audits
16A.29	Distributor audits

-
- 16A.30 Reconciliation participants audit
 - 16A.31 Dispatchable load purchaser audits
 - 16A.32 Distributed unmetered load audits
-

16A.1 Contents of this Part

This Part specifies obligations on **participants** that perform functions under Parts 10, 11, 13 and 15 in respect of **audits** required under the following clauses:

- (a) 10.17A (**Metering equipment providers** and **ATHs** to arrange for regular **audits**):
- (b) 10.17B (**Authority** and **participant** requested **audits**):
- (c) 11.8B (**Metering equipment providers** to arrange for regular **audits**):
- (d) 11.10 (**Distributors** to arrange for regular **audits**):
- (e) 11.11 (**Authority** and **participant** requested **audits**):
- (ea) 13.138C (**Generators** to arrange for regular **audits**);
- (f) 15.37A (**Reconciliation participants** to arrange for regular **audits**):
- (g) 15.37B (**Retailers** to arrange for **audits** in respect of **distributed unmetered load**):
- (h) 15.37C (**Authority** and **participant** requested **audits**).

Clause 16A.1 and subclauses (a) to (h): amended, on 1 March 2024, by clause 125 of the Electricity Industry Participation Code Amendment (Code Review Programme) 2024.

Clause 16A.1(ea): inserted, on 1 March 2024, by clause 125(7) of the Electricity Industry Participation Code Amendment (Code Review Programme) 2024.

16A.2 Purpose of this Part

The purpose of this Part is to require the performance of **audits** to support the accurate settlement and operation of the wholesale **electricity** market.

Subpart 1—Conduct of audits generally

16A.3 Auditors

- (1) An **audit** must be undertaken by—
 - (a) the **Authority**; or
 - (b) an **auditor** appointed by the **participant** that is the subject of the proposed **audit**, from the list of **auditors** the **Authority publishes** under clause 16A.5(6).
- (2) Despite subclause (1)(b), if an **audit** is carried out under clause 10.17B, 11.11, or 15.37C,—
 - (a) the **Authority** must carry out the **audit** or appoint an **auditor** to carry out the **audit**; and
 - (b) an **auditor** appointed by the **Authority** need not be an **auditor** from the list of **auditors** the **Authority publishes** under clause 16A.5(6).

Clause 16A.3(1)(b) and (2)(b): amended, on 5 October 2017, by clause 572 of the Electricity Industry Participation Code Amendment (Code Review Programme) 2017.

16A.4 Participants to give access

- (1) A **participant** must give the **Authority** or an **auditor** full access to all information that may be required for the purposes of carrying out an **audit**.
- (2) The **participant** must provide the information—
 - (a) at no charge; and
 - (b) no later than 15 **business days** after receiving a request for the information from the **Authority** or an **auditor**.

16A.5 Approval of auditors by the Authority

-
- (1) The **Authority**—
 - (a) may approve a person to be an **auditor**; and
 - (b) must specify the types of **audits** for which each such person is approved.
 - (2) An applicant for approval as an **auditor**, or renewal of an existing approval, must apply to the **Authority** using the **prescribed form**.
 - (3) The **Authority** may require an applicant to do any or all of the following:
 - (a) provide additional information or clarify any information provided;
 - (b) attend an interview;
 - (c) undertake an examination.
 - (4) The **Authority** must, no later than 2 months after receiving an application and, if applicable, the applicant has complied with subclause (3)—
 - (a) make a decision in relation to the application; and
 - (b) advise the applicant of the decision.
 - (5) If the **Authority** approves an application, the **Authority** must specify the date on which the approval expires in its advice to the applicant under subclause (4)(b), which must not be more than 36 months after the date of the approval.
 - (6) The **Authority** must **publish**, and keep updated, a list of the **auditors** that the **Authority** has approved, and the types of **audits** for which each **auditor** is approved.

Clause 16A.5(6): amended, on 5 October 2017, by clause 573 of the Electricity Industry Participation Code Amendment (Code Review Programme) 2017.

16A.6 Expiry and cancellation of approval

- (1) An **auditor's** approval expires on the date specified for its expiry under clause 16A.5(5).
- (2) The **Authority** may cancel an **auditor's** approval at any time by advising the **auditor** in writing.
- (3) The cancellation or expiry of an **auditor's** approval does not invalidate an **audit** previously completed by the **auditor**, but an **audit** completed after the date on which the **Authority** cancelled the **auditor's** approval, or after the date on which the **auditor's** approval expired, is not a valid **audit** for the purposes of this Code.

16A.7 Requirement to appoint new auditor

- (1) Unless otherwise agreed with the **Authority**, a **participant** must appoint a new **auditor** to perform a type of **audit** at the later of—
 - (a) 24 months after an **auditor** first performs an **audit** of that type in respect of the **participant**; or
 - (b) after an **auditor** has performed 2 consecutive **audits** of that type in respect of the **participant**.
- (2) A new **auditor** is an **auditor** that did not perform the last **audit** of the relevant type in respect of the **participant**.
- (3) For the purposes of subclause (1),—
 - (a) an **audit** completed under clause 16A.11 must be disregarded in determining the number of **audits** that an **auditor** has performed; and
 - (b) a type of **audit** refers to an **audit** under any 1 of paragraphs (a), (c), (d), (f) or (g) of clause 16A.1.

16A.8 Combined audits

-
- (1) A **participant** that is required to carry out an **audit** in accordance with this Part under more than 1 clause of this Code must arrange for a single **audit** report to be completed in respect of all of its obligations that relate to its role as a single type of industry **participant** or industry service provider.
 - (2) A **participant** that is required to carry out an **audit** in accordance with this Part in relation to more than 1 of its roles as an industry **participant** or industry service provider must arrange for a separate **audit** report to be completed in respect of its obligations for each of those roles.
 - (3) For example, a **participant** that is both a **metering equipment provider** and a **reconciliation participant**—
 - (a) must arrange for a single **audit** report to be completed that relates to all of its obligations as a **metering equipment provider**; and
 - (b) must arrange for a separate **audit** report to be completed that relates to its obligations as a **reconciliation participant**.
 - (4) Despite subclauses (1) and (2), a **retailer** that is responsible for **distributed unmetered load** must ensure that a separate **audit** report is completed in respect of the **distributed unmetered load** from any other **audit** report required under this Code.

16A.9 Authority may specify emphasis or scope of audit

- (1) If the **Authority** advises a **participant** that it requires an **audit** to give emphasis to any aspect of the **participant's** systems or processes, the **participant** must instruct the **auditor** to give emphasis to that aspect in the **audit** report.
- (2) If an **audit** is carried out under clause 10.17B, 11.11, or 15.37C, the **Authority** may specify the scope of the **audit**.
- (3) If the **Authority** advises a **participant** under subclause (1), or specifies the scope of an **audit** under subclause (2), the **Authority** must give the **participant** concerned its reasons for doing so.

16A.10 Agent audits

If a **participant** appoints an agent to perform any of the **participant's** obligations under this Code in respect of which an **audit** is required under any of the clauses specified in clause 16A.1, the **participant** must ensure that—

- (a) the agent has been **audited** to a standard that would have been required if the **participant** had performed the obligations itself; and
- (b) the information produced as a result of the **audit** of the agent is included in the **auditor's audit** report produced under clause 16A.12.

Clause 16A.10: amended, on 5 October 2017, by clause 574 of the Electricity Industry Participation Code Amendment (Code Review Programme) 2017.

16A.11 Audit required if participant makes material change

- (1) If there is a material change to any of a **participant's** systems or processes that are the subject of regular **audits** under clause 10.17A, 11.8B, 11.10, 15.37A or 15.37B, the **participant** must arrange for an additional **audit**, which must be completed in accordance with this Part no later than 5 **business days** before the change is implemented.
- (2) For the purposes of subclause (1), a material change to a system or process is a change that is likely to affect the ability of the **participant** to comply with any relevant provision of this Code.

16A.12 Process for completion of audits

- (1) Subject to subclause (2), a **participant** that is the subject of an **audit** must ensure that the **auditor** carrying out the **audit** complies with the following requirements:
 - (a) the **audit** report must be in the **prescribed form**;
 - (b) the **auditor** must send a draft of the **audit** report, setting out the provisional findings of the **audit**, to the **participant** that is the subject of the **audit**;
 - (c) the **auditor** must consider any comments it receives from the **participant** about the draft **audit** report;
 - (d) the **auditor** must produce a final **audit** report and give the report to the **participant** after considering any comments under paragraph (c);
 - (e) the final **audit** report must—
 - (i) list each agent engaged by the **participant** to perform any of the **participant's** activities under the relevant provisions of this Code, and details of the obligations that the agent performs; and
 - (ii) identify, in relation to the relevant period, the extent to which the **participant** has failed to comply with the provisions of this Code to which the **audit** relates; and
 - (iii) identify any areas for improvement; and
 - (iv) specify any conditions that the **auditor** considers the **participant** must satisfy in order to comply with the provisions of this Code to which the **audit** relates, and any action that the **participant** has taken in respect of those conditions; and
 - (v) include a recommendation as to the date by which the **auditor** considers that the **participant** should complete its next **audit**; and
 - (vi) include any of the **participant's** comments on the draft **audit** report that the **auditor** considers relevant.
- (2) If the **Authority** carries out the **audit**, or appoints an **auditor** to carry out the **audit**, the **Authority** must ensure that the requirements specified in subclause (1) are complied with.

16A.13 Participants to give final audit report and compliance plan to the Authority

- (1) A **participant** must give the final **audit** report to the **Authority** no later than the date by which the **audit** is due to be completed.
- (2) Each **participant** must submit a compliance plan to the **Authority** when it gives a final **audit** report to the **Authority** under subclause (1).
- (3) Each **participant** must—
 - (a) provide the compliance plan and final **audit** report in the **prescribed form**; and
 - (b) deliver the compliance plan and final **audit** report in the manner specified by the **Authority**.
- (4) Each compliance plan must specify—
 - (a) the actions that the **participant** intends to take to address any breaches or potential breaches of this Code identified in the **audit** report; and
 - (b) the time frames within which the **participant** intends to complete those actions.
- (5) Subclause (2) does not apply if the relevant final **audit** report in relation to a **participant** identifies no breaches or potential breaches of this Code.

Clause 16A.13(3): amended, on 31 December 2021, by clause 76(1) of the Electricity Industry Participation Code Amendment (Code Review Programme) 2019.

Clause 16A.13(5): amended, on 31 December 2021, by clause 76(2) of the Electricity Industry Participation Code Amendment (Code Review Programme) 2019.

16A.14 Authority to make determination as to next audit date

- (1) The **Authority** must, after receiving a final **audit** report and compliance plan (if any) from a **participant**, advise the **participant** of the date by which the next **audit** of the **participant** must be completed, which must be—
 - (a) no earlier than 3 months after the date on which the **Authority** advises the **participant** under this subclause; and
 - (b) no later than 36 months after the date of the last **audit**.
- (2) For the purposes of subclause (1) and clauses 16A.17, 16A.19, 16A.22, 16A.24, 16A.25, and 16A.26, an **audit** is complete when the **participant** that is the subject of the **audit** gives the **Authority** the final **audit** report and a compliance plan (if any) under clause 16A.13.
- (3) This clause does not apply to **audits** carried out under clause 10.17B, 11.11, 15.37C, or 16A.11.

16A.14A Authority may require participant to undertake audit

- (1) This clause applies if a **participant**—
 - (a) was required to carry out an **audit** in accordance with this Part and failed to complete the **audit** and give a final **audit** report to the **Authority** in accordance with clause 16A.13; or
 - (b) was exempted under section 11 of the **Act** from giving a final **audit** report to the **Authority** in accordance with clause 16A.13 and that exemption has expired or was revoked.
- (2) The **Authority** may advise the **participant**—
 - (a) if subclause (1)(a) applies, of the date by which the **participant** must complete the next **audit** that the **participant** is required to carry out in accordance with this Part; or
 - (b) if subclause (1)(b) applies, of the date by which the **participant** must complete the first **audit** that the **participant** is required to carry out in accordance with this Part since the exemption expired or was revoked.
- (3) The **Authority** must not advise the **participant** of a date under subclause (2) that is any earlier than 3 months after the date that the **Authority** gives the advice to the **participant**.
- (4) The date the **Authority** advises under subclause (2) is the date by which the **participant** must complete the **audit** for the purposes of clause 16A.14.

Clause 16A.14A: inserted, on 1 March 2024, by clause 126 of the Electricity Industry Participation Code Amendment (Code Review Programme) 2024.

16A.15 Authority to publish information

- (1) The **Authority** must **publish** the following information:
 - (a) each final **audit** report received under clause 16A.13;
 - (b) the compliance plan (if any) that the relevant **participant** submitted in relation to each final **audit** report;
 - (c) the date by which the next **audit** of the **participant** must be completed, as determined under clause 16A.14.
- (2) The **Authority** must **publish** the information no later than 20 **business days** after advising the relevant **participant** of the date by which the next **audit** of the **participant** must be completed under clause 16A.14.
- (3) The **Authority** is not required to **publish** the information if doing so—
 - (a) would disclose a trade secret; or

- (b) would be likely unreasonably to prejudice the commercial position of the person who supplied or is the subject of the information.

Clause 16A.15 Heading: amended, on 5 October 2017, by clause 575(1) of the Electricity Industry Participation Code Amendment (Code Review Programme) 2017.

Clause 16A.15(1), (2) and (3): amended, on 5 October 2017, by clause 575(2) of the Electricity Industry Participation Code Amendment (Code Review Programme) 2017.

16A.16 Costs of audits

- (1) The cost of an **audit** carried out under clause 10.17A, 11.8B, 11.10, 15.37A, 15.37B, or 16A.11 must be met by the **participant** that is the subject of the **audit**.
- (2) The cost of an **audit** carried out under clause 10.17B, 11.11, or 15.37C must be met in accordance with subclauses (3) to (5).
- (3) If an **audit** establishes that the **participant** that was the subject of the **audit** has breached the relevant provisions of this Code, the cost of the **audit** must be met by,—
 - (a) in respect of an **audit** carried out as a result of the **Authority** initiating the **audit**, the **participant** that was the subject of the **audit** and the **Authority**, in proportions to be determined by the **Authority**;
 - (b) in respect of an **audit** carried out in response to a request to the **Authority** under clause 10.17B(2), 11.11(2), or 15.37C(2), the **participant** that was the subject of the **audit** and the **participant** that requested the **audit**, in proportions to be determined by the **Authority**.
- (4) If the **audit** establishes that the **participant** that was the subject of the **audit** has not breached the relevant provisions of this Code, or if there was a breach but the **Authority** considers it to be minor, the cost of the **audit** must be met by,—
 - (a) in respect of an **audit** carried out as a result of the **Authority** initiating the **audit**, the **Authority**;
 - (b) in respect of an **audit** carried out in response to a request to the **Authority** under clause 10.17B(2), 11.11(2), or 15.37C(2), the **participant** that was the subject of the **audit** and the **participant** that requested the **audit**, in proportions to be determined by the **Authority**.
- (5) The costs under subclauses (3) and (4)(b) must be paid by the **participants** no later than 10 **business days** after being advised of the amount owing.

Subpart 2—Metering equipment provider audits

16A.17 Time frame for metering equipment provider audits

In relation to **audits** required under clauses 10.17A and 11.8B, a **metering equipment provider** must ensure that—

- (a) an initial **audit** is completed no later than 3 months after the date on which the **metering equipment provider's** obligations under Part 10 commence in accordance with clause 10.19; and
- (b) further **audits** are completed as specified by the **Authority** under clause 16A.14.

16A.18 Additional requirements for metering equipment provider audits

In addition to the requirements specified in clauses 16A.3 to 16A.16, a **metering equipment provider** must ensure that an **auditor** carrying out an **audit** required under clause 10.17A or 11.8B **audits**—

-
- (a) the management and maintenance of each **metering installation** for which the **metering equipment provider** is responsible, including—
 - (i) maintenance of **metering records**; and
 - (ii) maintenance of **metering components**; and
 - (iii) **certification** of **metering components** and **metering installations**; and
 - (iv) **metering installations** that have been **certified** at a lower category under clause 6 of Schedule 10.7; and
 - (v) inspections of **metering installations** in accordance with this Code; and
 - (vi) investigations under clause 10.43(4); and
 - (b) the **metering equipment provider's**—
 - (i) provision of **metering records** to the **registry manager** and the maintenance of that information in the **registry**; and
 - (ii) provision of **metering records** to the **reconciliation manager**; and
 - (c) the **metering equipment provider's** provision of access under Part 10 to—
 - (i) **raw meter data**;
 - (ii) **metering records**;
 - (iii) the **metering installation**; and
 - (d) the security of—
 - (i) each **metering installation** for which the **metering equipment provider** is responsible; and
 - (ii) if relevant, the **metering equipment provider's back office**; and
 - (iii) if relevant, the **communication** between the **metering equipment provider's back office** and the **metering installation**.

Clause 16A.18(b): replaced, on 5 October 2017, by clause 576 of the Electricity Industry Participation Code Amendment (Code Review Programme) 2017.

Subpart 3—ATH audits

16A.19 Time frame for ATH audits

In relation to **audits** required under clause 10.17A, an **ATH** (or an applicant for approval as an **ATH**) must ensure that—

- (a) an initial **audit** is completed no later than 2 months before the date on which the **ATH** (or the applicant for approval as an **ATH**) intends to be approved as an **ATH** under clause 1 of Schedule 10.3; and
- (b) further **audits** are completed as specified by the **Authority** under clause 16A.14.

16A.20 Additional requirements for class B ATH audits

In addition to the requirements specified in clauses 16A.3 to 16A.16, a **class B ATH** (or an applicant for approval as a **class B ATH**) must ensure that the **auditor** carrying out an **audit** **audits** the **class B ATH** (or the applicant) in respect of the requirements of NZ/AS ISO 17025 for **calibration** that apply to the performance of the functions for which the **class B ATH** (or the applicant) is being **audited**.

16A.21 Incorporation of NZ/AS ISO 17025 by reference

- (1) The New Zealand Standard NZ/AS ISO 17025 is incorporated by reference in this Code.
- (2) *[Revoked]*

Clause 16A.21(1): amended, on 1 August 2023, by clause 49(1) of the Electricity Industry Participation Code Amendment (System Operation Documents) 2023.

Clause 16A.21(2): revoked, on 1 August 2023, by clause 49(2) of the Electricity Industry Participation Code Amendment (System Operation Documents) 2023.

Subpart 4—Distributor audits

16A.22 Time frame for distributor audits

In relation to **audits** required under clause 11.10, a **distributor** must ensure that—

- (a) an initial **audit** is completed no later than 3 months after the date on which the **distributor** has the first **NSP identifier** or **ICP identifier** recorded in the **registry** as being part of the **distributor's network**; and
- (b) further **audits** are completed as specified by the **Authority** under clause 16A.14.

Clause 16A.22(a): amended, on 5 October 2017, by clause 577 of the Electricity Industry Participation Code Amendment (Code Review Programme) 2017.

16A.23 Additional requirements for distributor audits

In addition to the requirements specified in clauses 16A.3 to 16A.16, a **distributor** must ensure that the **auditor** carrying out an **audit** audits the **distributor's** processes and procedures in relation to—

- (a) the creation of **ICP identifiers** for **ICPs**; and
- (b) the provision of **ICP** information to the **registry manager** and the maintenance of that information in the **registry**; and
- (c) the creation and maintenance of **loss factors**.

Clause 16A.23(b): amended, on 5 October 2017, by clause 577(a) and (b) of the Electricity Industry Participation Code Amendment (Code Review Programme) 2017.

Subpart 5—Reconciliation participant audits

16A.24 Time frame for reconciliation participant audits

In relation to **audits** required under clause 15.37A, a **reconciliation participant** (or an applicant for **certification** as a **reconciliation participant**) must ensure that—

- (a) an initial **audit** is completed no later than 2 months before the date on which the **reconciliation participant** (or the applicant for **certification** as a **reconciliation participant**) is required to be **certified** as a **reconciliation participant** under clause 2A of Schedule 15.1; and
- (b) further **audits** are completed as specified by the **Authority** under clause 16A.14.

Subpart 6—Dispatchable load purchaser audits

16A.25 Time frame for dispatchable load purchaser audits

In relation to **audits** required under clause 15.37A, a **dispatchable load purchaser** must ensure that—

- (a) an initial **audit** is completed no later than 4 months after the date on which the **system operator** approves the first device or group of devices in respect of the **purchaser** to be a **dispatch-capable load station** under clause 13.3A; and
- (b) further **audits** are completed as specified by the **Authority** under clause 16A.14.

Subpart 6A – Generator audits

Subpart 6A Heading: inserted, on 1 March 2024, by clause 127 of the Electricity Industry Participation Code Amendment (Code Review Programme) 2024.

16A.25A Time frame for generator audits

In relation to **audits** required under clause 13.138C, a **generator** (or an applicant for **certification** as a **generator**) must ensure that—

- (a) an initial **audit** is completed no later than 2 months before the date on which the **generator** (or the applicant for **certification** as a **generator**) is required to be **certified** as a **generator** under clause 2A of Schedule 15.1; and
- (b) further **audits** are completed as specified by the **Authority** under clause 16A.14.

Clause 6A.25A: inserted, on 1 March 2024, by clause 127 of the Electricity Industry Participation Code Amendment (Code Review Programme) 2024.

Subpart 7—Distributed unmetered load audits

16A.26 Time frame for distributed unmetered load audits

- (1) In relation to **audits** required under clause 15.37B, a **retailer** that is responsible for **distributed unmetered load** must ensure that—
 - (a) an initial **audit** is carried out in respect of the **distributed unmetered load** no later than 3 months after the date on which information about an **ICP** associated with the **distributed unmetered load** is first provided by the **retailer** to the **reconciliation manager** as **submission information** under clause 15.4; and
 - (b) further **audits** are completed as specified by the **Authority** under clause 16A.14.
- (2) If responsibility for **distributed unmetered load** switches from one **retailer** to another, the **retailer** to which the responsibility switches must ensure that **audits** are completed in respect of the **distributed unmetered load** on the dates that would apply if the switch had not occurred.

Part 16A: inserted, on 1 June 2017 by clause 36 of the Electricity Industry Participation Code Amendment (Requirements and Processes for Audits) 2016.

Subpart 8 – Transitional provisions

Subpart 8 Heading: inserted, on 20 December 2021, by clause 77 of the Electricity Industry Participation Code Amendment (Code Review Programme) 2019.

16A.27 Metering equipment provider audits

- (1) If, on the date that the Electricity Industry Participation Code Amendment (Requirements and Processes for Audits) 2016 comes into force, the **Authority** has specified a date under clause 1(1)(b) of Schedule 10.5 by which a **metering equipment provider** must ensure that an **audit** is carried out, the **metering equipment provider** must ensure that an **audit** is completed in accordance with this Part by the later of—
 - (a) the date that the **Authority** has specified; or
 - (b) the date that is 1 month after the date that the Electricity Industry Participation Code Amendment (Requirements and Processes for Audits) 2016 comes into force.
- (2) If, on the date that the Electricity Industry Participation Code Amendment (Requirements and Processes for Audits) 2016 comes into force, the **Authority** has not specified a date under clause 1(1)(b) of Schedule 10.5 by which a **metering equipment provider** must ensure that an **audit** is carried out,—

-
- (a) the **Authority** must, no later than 1 month after the date that the Electricity Industry Participation Code Amendment (Requirements and Processes for Audits) 2016 comes into force, specify a date by which the **metering equipment provider** must ensure that an **audit** is carried out in accordance with this Part; and
 - (b) the **metering equipment provider** must comply with that requirement.
- (3) Clause 16A.17 applies to a **metering equipment provider** to which subclauses (1) or (2) apply as if the **audit** completed under those subclauses were the initial **audit** required under clause 16A.17(a).

Clause 16A.27: inserted, on 20 December 2021, by clause 77 of the Electricity Industry Participation Code Amendment (Code Review Programme) 2019.

16A.28 ATH audits

- (1) If, on the date that the Electricity Industry Participation Code Amendment (Requirements and Processes for Audits) 2016 comes into force, the **Authority** has specified a date under clause 1(4)(c) of Schedule 10.3 by which an **ATH** must ensure that an **audit** is carried out, the **ATH** must ensure that an **audit** is completed in accordance with this Part by the later of—
 - (a) the date that the **Authority** has specified; or
 - (b) the date that is 1 month after the date that the Electricity Industry Participation Code Amendment (Requirements and Processes for Audits) 2016 comes into force.
- (2) If, on the date that the Electricity Industry Participation Code Amendment (Requirements and Processes for Audits) 2016 comes into force, the **Authority** has not specified a date under clause 1(4)(c) of Schedule 10.3 by which an **ATH** must ensure that an **audit** is carried out,—
 - (a) the **Authority** must, no later than 1 month after the date that the Electricity Industry Participation Code Amendment (Requirements and Processes for Audits) 2016 comes into force, specify a date by which the **ATH** must ensure that an **audit** is carried out in accordance with this Part; and
 - (b) the **ATH** must comply with that requirement.
- (3) Clause 16A.19 applies to an **ATH** to which subclauses (1) or (2) apply as if the **audit** completed under those subclauses were the initial **audit** required under clause 16A.19(a)

Clause 16A.28: inserted, on 20 December 2021, by clause 77 of the Electricity Industry Participation Code Amendment (Code Review Programme) 2019.

16A.29 Distributor audits

- (1) If, immediately before the Electricity Industry Participation Code Amendment (Requirements and Processes for Audits) 2016 comes into force, a **distributor** was required to arrange for an **audit** to be completed by a date determined in accordance with clause 11.10(1)(b), the **distributor** must ensure that an **audit** is completed in accordance with this Part by the later of—
 - (a) the date determined in accordance with clause 11.10(1)(b); or
 - (b) the date that is 1 month after the date that the Electricity Industry Participation Code Amendment (Requirements and Processes for Audits) 2016 comes into force.
- (2) Clause 16A.22 applies to a **distributor** to which subclause (1) applies as if the **audit** completed under that subclause were the initial **audit** required under clause 16A.22(a).

Clause 16A.29: inserted, on 20 December 2021, by clause 77 of the Electricity Industry Participation Code Amendment (Code Review Programme) 2019.

16A.30 Reconciliation participant audits

- (1) If, immediately before the Electricity Industry Participation Code Amendment (Requirements and Processes for Audits) 2016 comes into force, a **reconciliation participant** was required

to provide a final **audit** report to the **Authority** by a date determined in accordance with clause 11(1) of Schedule 15.1, the **reconciliation participant** must ensure that an **audit** is completed in accordance with this Part by the later of—

- (a) the date determined in accordance with clause 11(1) of Schedule 15.1; or
- (b) the date that is 1 month after the date that the Electricity Industry Participation Code Amendment (Requirements and Processes for Audits) 2016 comes into force.

- (2) Clause 16A.24 applies to a **reconciliation participant** to which subclause (1) applies as if the **audit** completed under that subclause were the initial **audit** required under clause 16A.24(a).
Clause 16A.30: inserted, on 20 December 2021, by clause 77 of the Electricity Industry Participation Code Amendment (Code Review Programme) 2019.

16A.31 Dispatchable load purchaser audits

- (1) If, immediately before the Electricity Industry Participation Code Amendment (Requirements and Processes for Audits) 2016 comes into force, a **dispatchable load purchaser** was required to provide a final **audit** report to the **Authority** by a date determined in accordance with clause 11(1) of Schedule 15.1, the **dispatchable load purchaser** must ensure that an **audit** is completed in accordance with this Part by the later of—
 - (a) the date determined in accordance with clause 11(1) of Schedule 15.1; or
 - (b) the date that is 1 month after the date that the Electricity Industry Participation Code Amendment (Requirements and Processes for Audits) 2016 comes into force.

- (2) Clause 16A.25 applies to a **dispatchable load purchaser** to which subclause (1) applies as if the **audit** completed under that subclause were the initial **audit** required under clause 16A.25(a).

Clause 16A.31: inserted, on 20 December 2021, by clause 77 of the Electricity Industry Participation Code Amendment (Code Review Programme) 2019.

16A.32 Distributed unmetered load audits

- (1) A **retailer** that is responsible for **distributed unmetered load** on the date that the Electricity Industry Participation Code Amendment (Requirements and Processes for Audits) 2016 comes into force must ensure that an **audit** is completed in accordance with this Part no later than 12 months after that date.

- (2) Clause 16A.26(1) applies to a **retailer** to which subclause (1) applies as if the **audit** completed under that subclause were the initial **audit** required under clause 16A.26(1)(a).

Clause 16A.32: inserted, on 20 December 2021, by clause 77 of the Electricity Industry Participation Code Amendment (Code Review Programme) 2019.

Electricity Industry Participation Code 2010

Part 17 Transitional provisions

Contents

Transitional provisions relating to Part 1

- 17.1 Transitional provisions for definitions
- 17.2 Special definition of purchaser and payer

Transitional provisions relating to Part 2

- 17.3 *[Revoked]*

Transitional provisions relating to Part 3

- 17.4 *[Revoked]*
- 17.5 Insurance cover
- 17.6 *[Revoked]*
- 17.7 Disclosure to the Authority
- 17.8 *[Revoked]*
- 17.9 *[Revoked]*
- 17.10 *[Revoked]*
- 17.11 *[Revoked]*

Transitional provisions relating to Part 4

- 17.12 *[Revoked]*

Transitional provisions relating to Part 5

- 17.13 *[Revoked]*

Transitional provisions relating to Part 6

- 17.14 Approval to connect
- 17.15 Connection of distributed generation outside regulated terms
- 17.16 Connection of distributed generation on regulated terms
- 17.17 Obtaining approval to connect distributed generation under 10kW
- 17.18 Obtaining approval to connect distributed generation over 10kW
- 17.19 Confidentiality of information provided before connection
- 17.20 *[Revoked]*
- 17.21 Confidential information for regulated terms for
- 17.22 *[Revoked]*
- 17.23 *[Revoked]*
- 17.23A *[Revoked]*

Transitional provisions relating to Part 7

- 17.24 *[Revoked]*
- 17.25 *[Revoked]*
- 17.26 *[Revoked]*
- 17.27 *[Revoked]*

Transitional provisions relating to Part 8

- 17.28 *[Revoked]*
- 17.29 Existing contracts for higher levels of common quality
- 17.30 *[Revoked]*

- 17.31 *[Revoked]*
- 17.32 Information provisions
- 17.33 *[Revoked]*
- 17.34 Equivalence arrangement or dispensation
- 17.35 Excluded generating stations
- 17.36 *[Revoked]*
- 17.37 *[Revoked]*
- 17.38 Allocating ancillary services costs
- 17.39 *[Revoked]*
- 17.40 Connection of local networks in parallel with the grid
- 17.41 *[Revoked]*
- 17.42 *[Revoked]*
- 17.43 *[Revoked]*
- 17.44 Retention of records
- 17.45 Redistribution of automatic under-frequency load shedding
- 17.46 Notice
- 17.47 Specific requirements for document transmission communication
- 17.48 *[Revoked]*
- 17.48A Transitional provisions for extended reserve *[Revoked]*
- 17.48B Transitional provisions for change to frequency limit in South Island *[Revoked]*
- 17.48C Transitional provisions for exemptions to provide automatic under-frequency load shedding

Transitional provisions relating to Part 9

- 17.49 *[Revoked]*
- 17.50 Participant rolling outage plans
- 17.51 *[Revoked]*
- 17.52 *[Revoked]*
- 17.53 *[Revoked]*

Transitional provisions relating to Part 10

- 17.54 *[Revoked]*
- 17.55 *[Revoked]*
- 17.56 *[Revoked]*
- 17.57 *[Revoked]*
- 17.58 Approved test house
- 17.59 Certification of metering installations of Practice 10.3.
- 17.60 *[Revoked]*
- 17.61 Variation of requirements

Transitional provisions relating to Part 11

- 17.62 Requirement to provide complete and accurate information
- 17.63 ICP identifiers for ICPs
- 17.64 *[Revoked]*
- 17.65 Provision of ICP information
- 17.66 Provision of and changes to ICP and NSP information
- 17.67 *[Revoked]*
- 17.68 *[Revoked]*
- 17.69 Process for maintaining shared unmetered load

- 17.70 *[Revoked]*
 - 17.71 *[Revoked]*
 - 17.72 *[Revoked]*
 - 17.73 *[Revoked]*
 - 17.74 *[Revoked]*
 - 17.75 Access to the registry
 - 17.76 *[Revoked]*
 - 17.77 *[Revoked]*
 - 17.78 Dispensations
 - 17.79 Distributors to provide ICP information to registry
 - 17.80 Traders to provide ICP information to registry
 - 17.81 *[Revoked]*
 - 17.82 Management of ICP status by distributors and traders
 - 17.83 Updating table of loss category codes
 - 17.84 Updating loss factors for loss category codes
 - 17.85 Updating table of price category codes
 - 17.86 Balancing area information
 - 17.87 *[Revoked]*
 - 17.88 *[Revoked]*
 - 17.89 *[Revoked]*
 - 17.90 Reconciliation manager to allocate new identifiers
 - 17.91 Obligations concerning change in network owner
 - 17.92 *[Revoked]*
 - 17.93 *[Revoked]*
 - 17.94 *[Revoked]*
 - 17.95 *[Revoked]*
 - 17.96 *[Revoked]*
 - 17.97 Withdrawal of switch requests
 - 17.98 *[Revoked]*
 - 17.99 *[Revoked]*
 - 17.100 *[Revoked]*
 - 17.101 *[Revoked]*
 - 17.101A *[Revoked]*
- Transitional provisions relating to Part 12*
- 17.102 *[Revoked]*
 - 17.103 *[Revoked]*
 - 17.104 *[Revoked]*
 - 17.105 *[Revoked]*
 - 17.106 *[Revoked]*
 - 17.107 *[Revoked]*
 - 17.108 Increased services and reliability
 - 17.109 Approval of decreased services and reliability
 - 17.110 Approval of other variations to terms of benchmark agreement
 - 17.111 Customer specific value of unserved energy
 - 17.112 *[Revoked]*
 - 17.113 *[Revoked]*
 - 17.114 *[Revoked]*

- 17.115 [Revoked]
- 17.116 [Revoked]
- 17.117 [Revoked]
- 17.118 Development of transmission pricing methodology
- 17.119 [Revoked]
- 17.120 [Revoked]
- 17.121 [Revoked]
- 17.122 [Revoked]
- 17.123 [Revoked]
- 17.124 [Revoked]
- 17.125 [Revoked]
- 17.126 [Revoked]
- 17.127 [Revoked]

Transitional provisions relating to Part 13

- 17.128 [Revoked]
- 17.129 Approval process for industrial co-generating stations
- 17.129A [Revoked]
- 17.130 [Revoked]
- 17.131 [Revoked]
- 17.132 [Revoked]
- 17.133 [Revoked]
- 17.134 [Revoked]
- 17.135 Offers made by unit of plant
- 17.136 [Revoked]
- 17.137 [Revoked]
- 17.138 [Revoked]
- 17.139 [Revoked]
- 17.140 Retention of bids and offers
- 17.141 Special treatment of some grid exit points
- 17.142 [Revoked]
- 17.143 Transmission grid capability information to be updated
- 17.144 [Revoked]
- 17.145 [Revoked]
- 17.146 [Revoked]
- 17.147 [Revoked]
- 17.148 [Revoked]
- 17.149 [Revoked]
- 17.150 [Revoked]
- 17.151 Block dispatch may occur
- 17.152 System operator to notify block security constraints
- 17.153 Station dispatch may occur
- 17.154 System operator to notify security constraints
- 17.155 Generator notifies change from station to unit dispatch
- 17.156 [Revoked]
- 17.157 [Revoked]
- 17.158 [Revoked]
- 17.159 [Revoked]

- 17.160 *[Revoked]*
 - 17.161 *[Revoked]*
 - 17.162 *[Revoked]*
 - 17.163 *[Revoked]*
 - 17.164 Clearing manager must conduct auctions
 - 17.165 *[Revoked]*
 - 17.166 *[Revoked]*
 - 17.167 *[Revoked]*
 - 17.168 *[Revoked]*
 - 17.169 *[Revoked]*
 - 17.170 *[Revoked]*
 - 17.171 *[Revoked]*
 - 17.172 *[Revoked]*
 - 17.173 *[Revoked]*
 - 17.174 *[Revoked]*
 - 17.175 *[Revoked]*
 - 17.176 *[Revoked]*
 - 17.177 *[Revoked]*
 - 17.178 *[Revoked]*
 - 17.179 *[Revoked]*
 - 17.180 *[Revoked]*
 - 17.181 *[Revoked]*
 - 17.182 *[Revoked]*
 - 17.183 *[Revoked]*
 - 17.184 *[Revoked]*
 - 17.185 *[Revoked]*
 - 17.186 *[Revoked]*
 - 17.187 *[Revoked]*
 - 17.188 *[Revoked]*
 - 17.189 *[Revoked]*
 - 17.190 *[Revoked]*
 - 17.191 Information that must be submitted
 - 17.192 Calculation of contract price
 - 17.193 Information submitted
 - 17.194 Timeframes for submitting that information
- Transitional provisions relating to Part 14*
- 17.195 Acceptable forms of security
 - 17.196 Cash deposits
 - 17.197 *[Revoked]*
 - 17.198 *[Revoked]*
 - 17.199 *[Revoked]*
 - 17.200 *[Revoked]*
 - 17.201 *[Revoked]*
 - 17.202 *[Revoked]*
 - 17.203 *[Revoked]*
 - 17.204 *[Revoked]*
 - 17.205 Operating account

17.206 [Revoked]
17.207 [Revoked]
17.208 [Revoked]
17.209 [Revoked]
17.210 [Revoked]
17.210A [Revoked]
17.210B [Revoked]
17.210C [Revoked]
17.210D [Revoked]
17.210E [Revoked]
17.210F [Revoked]
17.210G [Revoked]
17.210H [Revoked]
17.210I [Revoked]
17.210J [Revoked]
17.210K [Revoked]
17.210L [Revoked]
17.210M [Revoked]
17.210N [Revoked]
17.210O [Revoked]

Transitional provisions relating to Part 15

17.211 [Revoked]
17.212 [Revoked]
17.213 [Revoked]
17.214 [Revoked]
17.215 [Revoked]
17.216 [Revoked]
17.217 [Revoked]
17.218 [Revoked]
17.219 [Revoked]
17.220 [Revoked]
17.221 Notification by embedded generators
17.222 Notification of changes to the grid
17.223 [Revoked]
17.224 [Revoked]
17.225 [Revoked]
17.226 [Revoked]
17.227 [Revoked]
17.228 [Revoked]
17.229 [Revoked]
17.230 [Revoked]
17.231 [Revoked]
17.232 [Revoked]
17.233 [Revoked]
17.234 [Revoked]
17.235 [Revoked]
17.236 [Revoked]

- 17.237 *[Revoked]*
- 17.238 *[Revoked]*
- 17.239 *[Revoked]*
- 17.240 *[Revoked]*
- 17.241 *[Revoked]*
- 17.242 Participant must use participant identifiers
- 17.243 Requirement for certification
- 17.244 *[Revoked]*
- 17.245 *[Revoked]*
- 17.246 *[Revoked]*
- 17.247 *[Revoked]*
- 17.248 *[Revoked]*
- 17.249 *[Revoked]*
- 17.250 *[Revoked]*
- 17.251 *[Revoked]*
- 17.252 *[Revoked]*
- 17.253 *[Revoked]*
- 17.254 *[Revoked]*
- 17.255 *[Revoked]*
- 17.256 *[Revoked]*
- 17.257 *[Revoked]*
- 17.258 *[Revoked]*
- 17.259 *[Revoked]*
- 17.260 *[Revoked]*
- 17.261 *[Revoked]*
- 17.262 Meter interrogation for half-hour metering
- 17.263 Audit trails
- 17.264 Correction of meter readings
- 17.265 Creation of submission information
- 17.266 *[Revoked]*
- 17.267 *[Revoked]*
- 17.268 Distributed unmetered load database
- 17.269 Calculation by difference for embedded networks
- 17.270 Calculation by difference for local networks
- 17.271 ICP days information
- 17.272 *[Revoked]*
- 17.273 Convert non half-hour quantities using profiles
- 17.274 Invalid submission information
- 17.275 *[Revoked]*
- 17.276 *[Revoked]*
- 17.277 *[Revoked]*
- 17.278 *[Revoked]*
- 17.279 *[Revoked]*
- 17.280 Provision of reconciliation information
- 17.281 Departure from requirements for profile administration
- 17.282 Profile population list
- 17.283 Profiles approved for use

- 17.284 *[Revoked]*
- 17.285 Profile codes
- 17.286 New NSP derived profiles
- 17.287 New statistically sampled/engineered profiles
- 17.288 MARIA profiles
- 17.289 *[Revoked]*
- 17.290 *[Revoked]*
- 17.291 *[Revoked]*

Transitional provisions relating to Part 16 [Revoked]

- 17.292 *[Revoked]*
- 17.293 *[Revoked]*
- 17.294 *[Revoked]*
- 17.295 *[Revoked]*

Transitional provisions relating to Part 16A

- 17.295A *[Revoked]*
- 17.295B *[Revoked]*
- 17.295C *[Revoked]*
- 17.295D *[Revoked]*
- 17.295E *[Revoked]*
- 17.295F *[Revoked]*

Transitional provisions relating to exemptions

- 17.296 *[Revoked]*
-

Transitional provisions relating to Part 1

17.1 Transitional provisions for definitions

- (1) Administrative costs agreed by the Board and the system operator in accordance with the definition of administrative costs in rule 1 of part A of the **rules** that were in force immediately before this Code came into force, are deemed to be **administrative costs** that have been agreed to by the **Authority** and the **system operator** in accordance with the definition of **administrative costs** in clause 1.1(1).
- (2) A declaration date nominated by a profile applicant in accordance with the definition of declaration date in rule 1 of part A of the **rules** that was in force immediately before this Code came into force, is deemed to be a **declaration date** nominated by a **profile applicant** in accordance with the definition of **declaration date** in clause 1.1(1).
- (3) A distributor kvar reference node approved by the system operator in accordance with the definition of distributor kvar reference node in rule 1 of part A of the **rules** that was in force immediately before this Code came into force, is deemed to be a **distributor kvar reference node** approved by the **system operator** in accordance with the definition of **distributor kvar reference node** in clause 1.1(1).
- (4) Expected interruption costs estimated by the Board under the definition of expected interruption costs in rule 1 of part A of the **rules** that were in force immediately before this Code came into force, are deemed to be **expected interruption costs** approved by the **Authority** in accordance with the definition of **expected interruption costs** in clause 1.1(1).

- (5) A grid exit point approved by the system operator under the definition of interruptible load group GXP in rule 1 of part A of the **rules** immediately before this Code came into force, is deemed to be a **grid exit point** approved by the **system operator** in accordance with the definition of **interruptible load group GXP** in clause 1.1(1).
- (6) A system operator register kept, maintained, or made available by the system operator in accordance with the definition of system operator register in rule 1 of part A of the **rules** immediately before this Code came into force, is deemed to be a **system operator register** kept, maintained, or made available, as the case may be, by the **system operator** in accordance with definition of **system operator register** in clause 1.1(1).

17.2 Special definition of purchaser and payer

- (1) A notice given under rule 5.2 of part A of the **rules** and in force immediately before this Code came into force, is deemed to be a notice given under clause 1.5(2), and may be—
 - (a) approved by the **Authority** (if it has not been approved by the Board); and
 - (b) revoked by the **participant** named in the notice as participant A or the **participant** in the notice named as participant B.
- (2) A notice published by the Board under rule 5.8 of part A of the **rules** before this Code came into force, is deemed to be a notice published by the **Authority** under clause 1.5(8).

Transitional provisions relating to Part 2

17.3 [Revoked]

Clause 17.3: revoked, on 20 December 2021, by clause 78 of the Electricity Industry Participation Code Amendment (Code Review Programme) 2019.

Transitional provisions relating to Part 3

17.4 [Revoked]

Clause 17.4: revoked, on 20 December 2021, by clause 79 of the Electricity Industry Participation Code Amendment (Code Review Programme) 2019.

17.5 Insurance cover

- (1) A requirement by the Commission that a service provider maintain insurance cover under regulation 36 of the Electricity Governance Regulations 2003 that was in force immediately before this Code came into force, is deemed to be a requirement by the **Authority** under clause 3.6.
- (2) An insurer approved by the Commission under regulation 36 of the Electricity Governance Regulations 2003 immediately before this Code came into force, is deemed to be approved by the **Authority** under clause 3.6 on the same terms and in respect of the same risks.

17.6 [Revoked]

Clause 17.6: revoked, on 20 December 2021, by clause 80 of the Electricity Industry Participation Code Amendment (Code Review Programme) 2019.

17.7 Disclosure to the Authority

Information received by a service provider to which regulation 42 of the Electricity Governance Regulations 2003 applied immediately before this Code came into force, is

deemed to be information received by the relevant **market operation service provider** on the day on which this Code came into force for the purposes of clause 3.11.

17.8 *[Revoked]*

Clause 17.8: revoked, on 20 December 2021, by clause 81 of the Electricity Industry Participation Code Amendment (Code Review Programme) 2019.

17.9 *[Revoked]*

Clause 17.9: revoked, on 20 December 2021, by clause 82 of the Electricity Industry Participation Code Amendment (Code Review Programme) 2019.

17.10 *[Revoked]*

Clause 17.10: revoked, on 20 December 2021, by clause 83 of the Electricity Industry Participation Code Amendment (Code Review Programme) 2019.

17.11 *[Revoked]*

Clause 17.11: revoked, on 20 December 2021, by clause 84 of the Electricity Industry Participation Code Amendment (Code Review Programme) 2019.

Transitional provisions relating to Part 4

17.12 *[Revoked]*

Clause 17.12: revoked, on 20 December 2021, by clause 85 of the Electricity Industry Participation Code Amendment (Code Review Programme) 2019.

Transitional provisions relating to Part 5

17.13 *[Revoked]*

Clause 17.13: revoked, on 20 December 2021, by clause 86 of the Electricity Industry Participation Code Amendment (Code Review Programme) 2019.

Transitional provisions relating to Part 6

17.14 Approval to connect

An approval granted by a distributor to a generator to connect distributed generation under regulation 7 of the Electricity Governance (Connection of Distributed Generation) Regulations 2007 that was in force immediately before this Code came into force, is deemed to be an approval granted to **connect distributed generation** under clause 6.4.

17.15 Connection of distributed generation outside regulated terms

A connection contract entered into by a distributor and a generator outside the regulated terms under regulation 8 of the Electricity Governance (Connection of Distributed Generation) Regulations 2007 that was in force immediately before this Code came into force, is deemed to be a **connection** contract outside the **regulated terms** under clause 6.5.

Clause 17.15: amended, on 23 February 2015, by clause 75 of the Electricity Industry Participation Code Amendment (Distributed Generation) 2014.

17.16 Connection of distributed generation on regulated terms

(1) If distributed electricity was connected on regulated terms under regulation 9 of the

Electricity Governance (Connection of Distributed Generation) Regulations 2007 immediately before this Code came into force, it is deemed to be **connected** on **regulated terms** under clause 6.6.

(2) *[Revoked]*

Clause 17.16(1): amended, on 23 February 2015, by clause 75 of the Electricity Industry Participation Code Amendment (Distributed Generation) 2014.

Clause 17.16(2): revoked, on 20 December 2021, by clause 87 of the Electricity Industry Participation Code Amendment (Code Review Programme) 2019.

17.17 Obtaining approval to connect distributed generation under 10kW

(1) *[Revoked]*

- (2) A generator approved to connect distributed generation under clause 3 of Schedule 1 of the Electricity Governance (Connection of Distributed Generation) Regulations 2007 immediately before this Code came into force, is deemed to have been approved to **connect distributed generation** under clause 3 of Schedule 6.1.

(3) *[Revoked]*

Clause 17.17(1) and (3): revoked, on 20 December 2021, by clause 88 of the Electricity Industry Participation Code Amendment (Code Review Programme) 2019.

17.18 Obtaining approval to connect distributed generation over 10kW

- (1) An initial application made by a generator to a distributor to connect distributed generation capable of generating electricity above 10kW under clause 11 of Schedule 1 of the Electricity Governance (Connection of Distributed Generation) Regulations 2007, for which the generator had not made a final application in respect of the generation immediately before this Code came into force, is deemed to be an **initial application** under clause 11 of Schedule 6.1.
- (2) Information provided under clauses 12 and 13 of Schedule 1 of the Electricity Governance (Connection of Distributed Generation) Regulations 2007 before this Code came into force, is deemed to be information provided under clauses 12 and 13 of Schedule 6.1.
- (3) A final application made under clause 15 of Schedule 1 of the Electricity Governance (Connection of Distributed Generation) Regulations 2007, on which a distributor had not made a decision immediately before this Code came into force, is deemed to be a **final application** made under clause 15 of Schedule 6.1.
- (4) A generator approved to connect distributed generation under clause 18 of Schedule 1 of the Electricity Governance (Connection of Distributed Generation) Regulations 2007 immediately before this Code came into force, is deemed to have been approved to **connect distributed generation** under clause 18 of Schedule 6.1.
- (5) Any conditions specified by a distributor in its decision on an application under clause 18 of Schedule 1 of the Electricity Governance (Connection of Distributed Generation) Regulations 2007 immediately before this Code came into force, are deemed to be conditions specified by the **distributor** under clause 18 of Schedule 6.1.
- (6) A notice of an intention to proceed made by a generator under clause 20 of the Electricity Governance (Connection of Distributed Generation) Regulations 2007 that was in force immediately before this Code came into force, is deemed to be a notice under clause 20 of Schedule 6.1.

17.19 Confidentiality of information provided before connection

Information provided with an application made under Schedule 1 of the Electricity

Governance (Connection of Distributed Generation) Regulations 2007 before this Code came into force, is subject to the confidentiality provisions in clause 25 of Schedule 6.1.

17.20 *[Revoked]*

Clause 17.20: revoked, on 20 December 2021, by clause 89 of the Electricity Industry Participation Code Amendment (Code Review Programme) 2019.

17.21 Confidential information for regulated terms for connection of distributed generation

- (1) Conditions specified under clause 18 of Schedule 2 of the Electricity Governance (Connection of Distributed Generation) Regulations 2007 apply as if they were specified under clause 17 of Schedule 6.2.
- (2) Information that came within the definition of confidential information under clause 16 of Schedule 2 of the Electricity Governance (Connection of Distributed Generation) Regulations 2007, is deemed to be **confidential information** as defined in clause 1.1(1).

17.22 *[Revoked]*

Clause 17.22: revoked, on 20 December 2021, by clause 90 of the Electricity Industry Participation Code Amendment (Code Review Programme) 2019.

17.23 *[Revoked]*

Clause 17.23: revoked, on 20 December 2021, by clause 91 of the Electricity Industry Participation Code Amendment (Code Review Programme) 2019.

17.23A *[Revoked]*

Clause 17.23A: inserted, on 9 January 2017, by clause 6 of the Electricity Industry Participation Code Amendment (Distributed Generation) 2016.

Clause 17.23A: revoked, on 5 October 2017, by clause 579 of the Electricity Industry Participation Code Amendment (Code Review Programme) 2017.

Transitional provisions relating to Part 7

17.24 *[Revoked]*

Clause 17.24: revoked, on 20 December 2021, by clause 92 of the Electricity Industry Participation Code Amendment (Code Review Programme) 2019.

17.25 *[Revoked]*

Clause 17.25: revoked, on 20 December 2021, by clause 93 of the Electricity Industry Participation Code Amendment (Code Review Programme) 2019.

17.26 *[Revoked]*

Clause 17.26: revoked, on 20 December 2021, by clause 94 of the Electricity Industry Participation Code Amendment (Code Review Programme) 2019.

17.27 *[Revoked]*

Clause 17.27: revoked, on 20 December 2021, by clause 95 of the Electricity Industry Participation Code Amendment (Code Review Programme) 2019.

Transitional provisions relating to Part 8

17.28 *[Revoked]*

Clause 17.28: revoked, on 20 December 2021, by clause 96 of the Electricity Industry Participation Code Amendment (Code Review Programme) 2019.

17.29 Existing contracts for higher levels of common quality

- (1) This clause applies if—
 - (a) **Transpower** and any person have a contract or an arrangement to maintain voltage at a **point of connection** that—
 - (i) was in force immediately before the **rules** came into force; and
 - (ii) remained in force after this Code came into force; and
 - (b) the effect of the contract or arrangement may cause the **system operator** to operate the **grid** voltage within a lesser range than the range set out in the **AOPOs**; and
 - (c) **Transpower** and the **system operator** have a matching contract or arrangement in that respect under clause 8.6.
- (2) When this clause applies, any incremental cost arising from the **system operator** operating within a lesser range under a contract or arrangement to which subclause (1)(c) applies—
 - (a) must not be allocated according to clause 8.6; but instead
 - (b) is an **allocable cost** and must be paid as set out in clauses 8.55 and 8.67.
- (3) Subclause (2) applies to the costs arising from a contract or arrangement to which subclause (1)(c) applies until the earlier of the following:
 - (a) the expiry date of the contract or arrangement;
 - (b) termination of the contract or arrangement;
 - (c) the end of the life of the **assets** employed in providing the voltage service provided for in the contract or arrangement.

17.30 *[Revoked]*

Clause 17.30: revoked, on 20 December 2021, by clause 97 of the Electricity Industry Participation Code Amendment (Code Review Programme) 2019.

17.31 *[Revoked]*

Clause 17.31: revoked, on 20 December 2021, by clause 98 of the Electricity Industry Participation Code Amendment (Code Review Programme) 2019.

17.32 Information provisions

- (1) A notice given by the system operator to an embedded generator under rule 4.5 of section III of part C of the **rules** that was in force immediately before this Code came into force, is deemed to be a notice issued by the **system operator** to an **embedded generator** under clause 8.25(5)(b).
- (2) *[Revoked]*
- (3) An approval given by the Commission under rule 4.6 of section III of part C of the **rules** immediately before this Code came into force, is deemed to be an approval given by the **Authority** under clause 8.25(6).

Clause 17.32(2): revoked, on 20 December 2021, by clause 99 of the Electricity Industry Participation Code Amendment (Code Review Programme) 2019.

17.33 *[Revoked]*

Clause 17.33: revoked, on 20 December 2021, by clause 100 of the Electricity Industry Participation Code Amendment (Code Review Programme) 2019.

17.34 Equivalence arrangement or dispensation

- (1) An approval of an equivalence arrangement under rule 7.2 of section III of part C of the **rules**, unless cancelled under rule 8.2 of section III of part C or revoked under rule 8.3 of section III of part C, that was in force immediately before this Code came into force, is deemed to be an approval of an **equivalence arrangement** under clause 8.30 and clause 8 of Schedule 8.1, as modified in accordance with rule 8.1 of section III of part C of the **rules**.
- (2) A grant of a dispensation under rule 7.3 of section III of part C of the **rules**, unless cancelled under rule 8.2 of section III of part C, or revoked or varied under rule 8.3 of section III of part C, that was in force immediately before this Code came into force, is deemed to be a grant of a **dispensation** under clause 8.31 and clause 8 of Schedule 8.1 as modified in accordance with rule 8.1 of section III of part C of the **rules**.
- (3) *[Revoked]*
- (4) *[Revoked]*
- (5) An agreement relating to the processing costs for the approval of an equivalence arrangement or the grant of a dispensation under clause 5 of schedule C1 of part C of the **rules** that was in force immediately before this Code came into force, is deemed to be an agreement under clause 5 of Schedule 8.1.
- (6) *[Revoked]*
Clause 17.34(3), (4) and (6): revoked, on 20 December 2021, by clause 101 of the Electricity Industry Participation Code Amendment (Code Review Programme) 2019.

17.35 Excluded generating stations

A directive issued by the Commission under rule 10 of section III of part C of the **rules** that was in force immediately before this Code came into force, is deemed to be a directive issued by the **Authority** under clause 8.38(2).

17.36 *[Revoked]*

Clause 17.36(1) and (2): expired, on 30 November 2012 by clause 17.36(3).
Clause 17.36: revoked, on 20 December 2021, by clause 102 of the Electricity Industry Participation Code Amendment (Code Review Programme) 2019.

17.37 *[Revoked]*

Clause 17.37: revoked, on 20 December 2021, by clause 103 of the Electricity Industry Participation Code Amendment (Code Review Programme) 2019.

17.38 Allocating ancillary services costs

- (1) *[Revoked]*
- (2) Actual administrative costs approved by the Commission under rule 11.1.2 of section IV of part C of the **rules** and in force immediately before this Code came into force, are deemed to be actual **administrative costs** under clause 8.55(1)(b).
- (3) *[Revoked]*
- (4) *[Revoked]*
- (5) *[Revoked]*
- (6) *[Revoked]*
- (7) *[Revoked]*
- (8) *[Revoked]*
- (9) *[Revoked]*

(10) *[Revoked]*

(11) *[Revoked]*

(12) *[Revoked]*

(13) *[Revoked]*

(14) *[Revoked]*

Clause 17.38(1): revoked, on 20 December 2021, by clause 104(1) of the Electricity Industry Participation Code Amendment (Code Review Programme) 2019.

Clause 17.38(2): amended, on 20 December 2021, by clause 104(2) of the Electricity Industry Participation Code Amendment (Code Review Programme) 2019.

Clause 17.38(3) to (14): revoked, on 20 December 2021, by clause 104(3) of the Electricity Industry Participation Code Amendment (Code Review Programme) 2019.

17.39 *[Revoked]*

Clause 17.39: revoked, on 20 December 2021, by clause 105 of the Electricity Industry Participation Code Amendment (Code Review Programme) 2019.

17.40 Connection of local networks in parallel with the grid

An agreement under clause 6 of technical code A of schedule C3 of part C of the **rules** that was in force immediately before this Code came into force, is deemed to be an agreement under clause 6 of **Technical Code A** of Schedule 8.3.

17.41 *[Revoked]*

Clause 17.41: revoked, on 20 December 2021, by clause 106 of the Electricity Industry Participation Code Amendment (Code Review Programme) 2019.

17.42 *[Revoked]*

Clause 17.42: revoked, on 20 December 2021, by clause 107 of the Electricity Industry Participation Code Amendment (Code Review Programme) 2019.

17.43 *[Revoked]*

Clause 17.43: revoked, on 20 December 2021, by clause 108 of the Electricity Industry Participation Code Amendment (Code Review Programme) 2019.

17.44 Retention of records

The **system operator** and each **participant** must retain records of formal notices issued under clause 4 of technical code B of schedule C3 of part C of the **rules**.

17.45 Redistribution of automatic under-frequency load shedding

An agreement to redistribute **automatic under-frequency load shedding** quantities between **grid exit points** under clause 6.4 of technical code B of schedule C3 of part C of the **rules** that was in force immediately before this Code came into force, is deemed to be an agreement under clause 7(8) of **Technical Code B** of Schedule 8.3

Clause 17.45: revoked, on 7 August 2014, by clause 34 of the Electricity Industry Participation Code Amendment (Extended Reserve) 2014.

Clause 17.45: replaced, on 21 December 2021, by clause 45 of the Electricity Industry Participation Code Amendment (Automatic Under-Frequency Load Shedding Systems) 2021.

17.46 Notice

A notice in relation to a participant under clause 6.5A.2 of technical code B of schedule C3 of part C of the **rules** that was in force immediately before this Code came into force, is deemed to be a notice in relation to a **participant** under clause 7(11) of **Technical Code B** of Schedule 8.3.

17.47 Specific requirements for document transmission communication

- (1) *[Revoked]*
- (2) An approval of primary or backup means of document transmission communication under clauses 4.1 or 4.2 of technical code C of schedule C3 of part C of the **rules** that was in force immediately before this Code came into force, is deemed to be an approval under clause 5(2) or (3), as the case may be, of **Technical Code C** of Schedule 8.3.
Clause 17.47(1): revoked, on 20 December 2021, by clause 109 of the Electricity Industry Participation Code Amendment (Code Review Programme) 2019.

17.48 *[Revoked]*

Clause 17.48: revoked, on 20 December 2021, by clause 110 of the Electricity Industry Participation Code Amendment (Code Review Programme) 2019.

17.48A *[Revoked]*

Clause 17.48A: inserted, on 7 August 2014, by clause 35 of the Electricity Industry Participation Code Amendment (Extended Reserve) 2014.
Clause 17.48A(3): amended, on 19 December 2014, by clause 43 of the Electricity Industry Participation Code Amendment (Minor Code Amendments) (No 3) 2014.
Clause 17.48A: revoked, on 5 October 2017, by clause 580 of the Electricity Industry Participation Code Amendment (Code Review Programme) 2017.

17.48B *[Revoked]*

Clause 17.48B: inserted, on 7 August 2014, by clause 35 of the Electricity Industry Participation Code Amendment (Extended Reserve) 2014.
Clause 17.48B: revoked, on 5 October 2017, by clause 581 of the Electricity Industry Participation Code Amendment (Code Review Programme) 2017.

17.48C Transitional provisions for exemptions to provide automatic under-frequency load shedding

Exemptions under section 11 of the **Act** to clause 8.19(5) of this Code and clauses 7(1), 7(8) and 7(9) of **Technical Code B** of Schedule 8.3 of this Code that were in force prior to this clause coming into force will continue to be in force until the earlier of—

- (a) 30 June 2022;
- (b) the date on which the exemption is superseded by the **system operator** approving an **equivalence arrangement** under clause 8.30.

Clause 17.48C: inserted, on 21 December 2021, by clause 46 of the Electricity Industry Participation Code Amendment (Automatic Under-Frequency Load Shedding Systems) 2021.

Transitional provisions relating to Part 9

17.49 *[Revoked]*

Clause 17.49: revoked, on 20 December 2021, by clause 111 of the Electricity Industry Participation Code Amendment (Code Review Programme) 2019.

17.50 Participant rolling outage plans

- (1) A notice given by the Commission to a specified participant under regulation 8A(2) of the Electricity Governance (Security of Supply) Regulations 2008 that was in force immediately before this Code came into force, is deemed to be a notice given by the **system operator** under clause 9.6(2).
- (2) *[Revoked]*
- (3) *[Revoked]*

(4) *[Revoked]*

(5) *[Revoked]*

(6) *[Revoked]*

(7) *[Revoked]*

(8) *[Revoked]*

(9) *[Revoked]*

(10) *[Revoked]*

(11) *[Revoked]*

Clause 17.50(2) to (11): revoked, on 20 December 2021, by clause 112 of the Electricity Industry Participation Code Amendment (Code Review Programme) 2019.

17.51 *[Revoked]*

Clause 17.51: revoked, on 20 December 2021, by clause 113 of the Electricity Industry Participation Code Amendment (Code Review Programme) 2019.

17.52 *[Revoked]*

Clause 17.52: revoked, on 20 December 2021, by clause 114 of the Electricity Industry Participation Code Amendment (Code Review Programme) 2019.

17.53 *[Revoked]*

Clause 17.53: revoked, on 20 December 2021, by clause 115 of the Electricity Industry Participation Code Amendment (Code Review Programme) 2019.

Transitional provisions relating to Part 10

17.54 *[Revoked]*

Clause 17.54 revoked, on 20 December 2021, by clause 116 of the Electricity Industry Participation Code Amendment (Code Review Programme) 2019.

17.55 *[Revoked]*

Clause 17.55: revoked, on 20 December 2021, by clause 117 of the Electricity Industry Participation Code Amendment (Code Review Programme) 2019.

17.56 *[Revoked]*

Clause 17.56: revoked, on 20 December 2021, by clause 118 of the Electricity Industry Participation Code Amendment (Code Review Programme) 2019.

17.57 *[Revoked]*

Clause 17.57: revoked, on 20 December 2021, by clause 119 of the Electricity Industry Participation Code Amendment (Code Review Programme) 2019.

17.58 Approved test house

(1) *[Revoked]*

(2) *[Revoked]*

(3) *[Revoked]*

(4) A data logger certified under clause 3.4 of code of practice D3 of part D of the **rules** immediately before this Code came into force, is deemed to be a **data logger** certified under clause 3.4 of **Code of Practice 10.3**.

(5) *[Revoked]*

Clause 17.58(1), (2), (3) and (5): revoked, on 20 December 2021, by clause 120 of the Electricity Industry Participation Code Amendment (Code Review Programme) 2019.

17.59 Certification of metering installations

- (1) A metering installation certified, or deemed by rule 6 of section III of part I of the **rules** to be certified, under clause 4 of code of practice D3 of part D of the **rules** immediately before this Code came into force, is deemed to be a **metering installation certified** under clause 4 of **Code of Practice 10.3**.
- (2) *[Revoked]*
- (3) A metering installation recertified under clause 5.4.2 of code of practice D3 of part D of the **rules** immediately before this Code came into force, is deemed to be a **metering installation recertified** under clause 7 of **Code of Practice 10.3**.

Clause 17.59(2): revoked, on 20 December 2021, by clause 121 of the Electricity Industry Participation Code Amendment (Code Review Programme) 2019.

17.60 *[Revoked]*

Clause 17.60: revoked, on 20 December 2021, by clause 122 of the Electricity Industry Participation Code Amendment (Code Review Programme) 2019.

17.61 Variation of requirements

A variation granted under code of practice D5 of part D of the **rules** that had not expired immediately before this Code came into force, is deemed to be a variation granted under **Code of Practice 10.5**.

Transitional provisions relating to Part 11

17.62 Requirement to provide complete and accurate information

For the purposes of clause 11.2(2), information provided by a participant under part E of the **rules** before this Code came into force, is deemed to be information provided under Part 11.

17.63 ICP identifiers for ICPs

An ICP identifier that applied to an ICP immediately before this Code came into force, is deemed to be an **ICP identifier** for that **ICP** created under this Code.

17.64 *[Revoked]*

Clause 17.64: revoked, on 20 December 2021, by clause 123 of the Electricity Industry Participation Code Amendment (Code Review Programme) 2019.

17.65 Provision of ICP information

Information provided by a distributor or a trader under rule 6 of part E of the **rules** before this Code came into force, is deemed to be information provided by a **distributor** or a **trader**, as the case may be, under clause 11.7.

17.66 Provision of and changes to ICP and NSP information

A notification given by a participant under rule 8.2 of part E of the **rules** that had not been processed immediately before this Code came into force, is deemed to be a notification given under clause 11.8(2).

17.67 *[Revoked]*

Clause 17.67: revoked, on 20 December 2021, by clause 124 of the Electricity Industry Participation Code Amendment (Code Review Programme) 2019.

17.68 *[Revoked]*

Clause 17.68: revoked, on 20 December 2021, by clause 125 of the Electricity Industry Participation Code Amendment (Code Review Programme) 2019.

17.69 Process for maintaining shared unmetered load

- (1) A notification provided by a distributor to the registry under rule 14.2 of part E of the **rules** that had not been processed immediately before this Code came into force, is deemed to be a notification provided under clause 11.14(2).
- (2) A notification provided by a trader to a distributor under rule 14.2A of part E of the **rules** that had not been processed immediately before this Code came into force, is deemed to be a notification provided under clause 11.14(3).
- (3) A notification provided by a distributor to the registry and each trader under rule 14.2B of part E of the **rules** that had not been processed immediately before this Code came into force, is deemed to be a notification provided under clause 11.14(4).
- (4) A notification provided by a distributor to all traders under rule 14.3 of part E of the **rules** that was in force immediately before this Code came into force, is deemed to be a notification provided under clause 11.14(5).

17.70 *[Revoked]*

Clause 17.70: revoked, on 20 December 2021, by clause 126 of the Electricity Industry Participation Code Amendment (Code Review Programme) 2019.

17.71 *[Revoked]*

Clause 17.71: revoked, on 20 December 2021, by clause 127 of the Electricity Industry Participation Code Amendment (Code Review Programme) 2019.

17.72 *[Revoked]*

Clause 17.72: revoked, on 20 December 2021, by clause 128 of the Electricity Industry Participation Code Amendment (Code Review Programme) 2019.

17.73 *[Revoked]*

Clause 17.73: revoked, on 20 December 2021, by clause 129 of the Electricity Industry Participation Code Amendment (Code Review Programme) 2019.

17.74 *[Revoked]*

Clause 17.74: revoked, on 20 December 2021, by clause 130 of the Electricity Industry Participation Code Amendment (Code Review Programme) 2019.

17.75 Access to registry

- (1) *[Revoked]*
- (2) Terms and conditions specified by the Board under rule 25.2 of part E of the **rules** that were in force immediately before this Code came into force, are deemed to be terms and conditions specified under clause 11.28(2).

(3) *[Revoked]*

Clause 17.75 heading: amended, on 20 December 2021, by clause 131(1) of the Electricity Industry Participation Code Amendment (Code Review Programme) 2019.

Clause 17.75(1) and (3): revoked, on 20 December 2021, by clause 131(2) of the Electricity Industry Participation Code Amendment (Code Review Programme) 2019.

17.76 *[Revoked]*

Clause 17.76: revoked, on 20 December 2021, by clause 132 of the Electricity Industry Participation Code Amendment (Code Review Programme) 2019.

17.77 *[Revoked]*

Clause 17.77: revoked, on 20 December 2021, by clause 133 of the Electricity Industry Participation Code Amendment (Code Review Programme) 2019.

17.78 Dispensations

A dispensation granted by the Board under clause 1.4 of schedule E1 of part E of the **rules** that was in force immediately before this Code came into force, is deemed to be a dispensation granted by the **Authority** under clause 4 of Schedule 11.1.

17.79 Distributors to provide ICP information to registry

Information provided by a distributor to the registry under clause 2 of schedule E1 of part E of the **rules** that had not been changed by the distributor under clause 2A of schedule E1 of part E of the **rules** immediately before this Code came into force, is deemed to be information provided to the registry under clause 7 of Schedule 11.1.

17.80 Traders to provide ICP information to registry

Information provided by a trader to the registry under clause 3 of schedule E1 of part E of the **rules** that had not been changed by the trader under clause 3A of schedule E1 of part E of the **rules** immediately before this Code came into force, is deemed to be information provided to the registry under clause 9 of Schedule 11.1.

Clause 17.80: amended, on 1 March 2024, by clause 128 of the Electricity Industry Participation Code Amendment (Code Review Programme) 2024.

17.81 *[Revoked]*

Clause 17.81: revoked, on 20 December 2021, by clause 134 of the Electricity Industry Participation Code Amendment (Code Review Programme) 2019.

17.82 Management of ICP status by distributors and traders

(1) The status of an ICP recorded on the registry and managed in accordance with clause 4 of schedule E1 of part E of the **rules** immediately before this Code came into force, is deemed to be the status of the **ICP** recorded on the **registry** and managed by **distributors** or **traders**, as the case may be, in accordance with clauses 12 to 20 of Schedule 11.1, as the case may be.

(2) *[Revoked]*

(3) *[Revoked]*

(4) *[Revoked]*

Clause 17.82(2), (3) and (4): revoked, on 20 December 2021, by clause 135 of the Electricity Industry Participation Code Amendment (Code Review Programme) 2019.

17.83 Updating table of loss category codes

A loss category code entered in the table in the registry under clause 5 of schedule E1 of part E of the **rules** and in force immediately before this Code came into force, is deemed to be a **loss category** code entered in accordance with clause 21 of Schedule 11.1.

17.84 Updating loss factors for loss category codes

A loss factor entered in the table in the registry under clause 5A of schedule E1 of part E of the **rules** that is in force immediately before this Code came into force, is deemed to be a **loss factor** entered in accordance with clause 22 of Schedule 11.1.

17.85 Updating table of price category codes

A price category code entered in the table in the registry under clause 6 of schedule E1 of part E of the **rules** that is in force immediately before this Code came into force, is deemed to be a **price category** code entered in accordance with clause 23 of Schedule 11.1.

17.86 Balancing area information

- (1) A notification given to the reconciliation manager under clause 7.1 of schedule E1 of part E of the **rules** that was in force immediately before this Code came into force, is deemed to be a notification given under clause 24(1) of Schedule 11.1.
- (2) A notification of a change of information given to the reconciliation manager under clause 7.1A of schedule E1 of part E of the **rules** that was in force immediately before this Code came into force, is deemed to a notification given under clause 24(2) of Schedule 11.1.
- (3) A notification given by the reconciliation manager to the registry of changes to balancing areas under clause 7.2 of schedule E1 of part E of the **rules** that was in force immediately before this Code came into force, is deemed to be a notification given under clause 24(4) of Schedule 11.1.
- (4) A schedule published by the registry under clause 7.3 of schedule E1 of part E of the **rules** that was in force immediately before this Code came into force, is deemed to be a schedule published under clause 24(5) of Schedule 11.1.

17.87 [Revoked]

Clause 17.87: revoked, on 20 December 2021, by clause 136 of the Electricity Industry Participation Code Amendment (Code Review Programme) 2019.

17.88 [Revoked]

Clause 17.88: revoked, on 20 December 2021, by clause 137 of the Electricity Industry Participation Code Amendment (Code Review Programme) 2019.

17.89 [Revoked]

Clause 17.89: revoked, on 20 December 2021, by clause 138 of the Electricity Industry Participation Code Amendment (Code Review Programme) 2019.

17.90 Reconciliation manager to allocate new identifiers

An NSP identifier allocated by the reconciliation manager under clause 11 of schedule E1 of part E of the **rules** and in force immediately before this Code came into force, is deemed to be an NSP identifier allocated under clause 28 of Schedule 11.1.

17.91 Obligations concerning change in network owner

A notification given by a network owner under clause 12 of schedule E1 of part E of the **rules** that was in force immediately before this Code came into force, is deemed to be a notification given under clause 29 of Schedule 11.1.

17.92 *[Revoked]*

Clause 17.92: revoked, on 20 December 2021, by clause 139 of the Electricity Industry Participation Code Amendment (Code Review Programme) 2019.

17.93 *[Revoked]*

Clause 17.93: revoked, on 20 December 2021, by clause 140 of the Electricity Industry Participation Code Amendment (Code Review Programme) 2019.

17.94 *[Revoked]*

Clause 17.94: revoked, on 20 December 2021, by clause 141 of the Electricity Industry Participation Code Amendment (Code Review Programme) 2019.

17.95 *[Revoked]*

Clause 17.95: revoked, on 20 December 2021, by clause 142 of the Electricity Industry Participation Code Amendment (Code Review Programme) 2019.

17.96 *[Revoked]*

Clause 17.96: revoked, on 20 December 2021, by clause 143 of the Electricity Industry Participation Code Amendment (Code Review Programme) 2019.

17.97 Withdrawal of switch requests

- (1) Codes for withdrawing a switch request determined and published by the Board under clause 4.1 of schedule E2 of part E of the **rules** before this Code came into force, are deemed to be codes determined and published by the **Authority** under clause 18(b) of Schedule 11.3.
- (2) *[Revoked]*
- (3) *[Revoked]*
- (4) *[Revoked]*
- (5) *[Revoked]*
- (6) *[Revoked]*

Clause 17.97(2) to (6): revoked, on 20 December 2021, by clause 144 of the Electricity Industry Participation Code Amendment (Code Review Programme) 2019.

17.98 *[Revoked]*

Clause 17.98: revoked, on 20 December 2021, by clause 145 of the Electricity Industry Participation Code Amendment (Code Review Programme) 2019.

17.99 *[Revoked]*

Clause 17.99: revoked, on 20 December 2021, by clause 146 of the Electricity Industry Participation Code Amendment (Code Review Programme) 2019.

17.100 *[Revoked]*

Clause 17.100: revoked, on 20 December 2021, by clause 147 of the Electricity Industry Participation Code Amendment (Code Review Programme) 2019.

17.101 *[Revoked]*

Clause 17.101: revoked, on 20 December 2021, by clause 148 of the Electricity Industry Participation Code Amendment (Code Review Programme) 2019.

17.101A *[Revoked]*

Clause 17.101A: inserted, on 9 October 2015, by clause 28 of the Electricity Industry Participation Code Amendment (ICP Switching) 2014.

Clause 17.101A(2): amended, on 9 October 2015, by clause 17 of the Electricity Industry Participation Code Amendment (ICP Switching) 2015.

Clause 17.101A: revoked, on 20 December 2021, by clause 149 of the Electricity Industry Participation Code Amendment (Code Review Programme) 2019.

Transitional provisions relating to Part 12

17.102 [Revoked]

Clause 17.102: revoked, on 20 December 2021, by clause 150 of the Electricity Industry Participation Code Amendment (Code Review Programme) 2019.

17.103 [Revoked]

Clause 17.103: revoked, on 20 December 2021, by clause 151 of the Electricity Industry Participation Code Amendment (Code Review Programme) 2019.

17.104 [Revoked]

Clause 17.104: revoked, on 20 December 2021, by clause 152 of the Electricity Industry Participation Code Amendment (Code Review Programme) 2019.

17.105 [Revoked]

Clause 17.105: revoked, on 20 December 2021, by clause 153 of the Electricity Industry Participation Code Amendment (Code Review Programme) 2019.

17.106 [Revoked]

Clause 17.106: revoked, on 20 December 2021, by clause 154 of the Electricity Industry Participation Code Amendment (Code Review Programme) 2019.

17.107 [Revoked]

Clause 17.107: revoked, on 20 December 2021, by clause 155 of the Electricity Industry Participation Code Amendment (Code Review Programme) 2019.

17.108 Increased services and reliability

A certification given under rule 5.1 of section II of part F of the **rules** immediately before this Code came into force, is deemed to be confirmation given under clause 12.35.

Clause 17.108: amended, on 1 March 2024, by clause 129 of the Electricity Industry Participation Code Amendment (Code Review Programme) 2024.

17.109 Approval of decreased services and reliability

An approval given under rule 5.2 of section II of part F of the **rules** that was in force immediately before this Code came into force, is deemed to be an approval given under clause 12.36.

17.110 Approval of other variations to terms of benchmark agreement

An approval given under rule 5.4 of section II of part F of the **rules** that was in force immediately before this Code came into force, is deemed to be an approval given under clause 12.38.

17.111 Customer specific value of unserved energy

(1) *[Revoked]*

(2) *[Revoked]*

- (3) An approval given under rule 5.5.4.1 of section II of part F of the **rules** that was in force immediately before this Code came into force, is deemed to be an approval given under clause 12.39(5)(a).

Clause 17.111(1) and (2): revoked, on 20 December 2021, by clause 156 of the Electricity Industry Participation Code Amendment (Code Review Programme) 2019.

17.112 *[Revoked]*

Clause 17.112: revoked, on 20 December 2021, by clause 157 of the Electricity Industry Participation Code Amendment (Code Review Programme) 2019.

17.113 *[Revoked]*

Clause 17.113: revoked, on 20 December 2021, by clause 158 of the Electricity Industry Participation Code Amendment (Code Review Programme) 2019.

17.114 *[Revoked]*

Clause 17.114: revoked, on 20 December 2021, by clause 159 of the Electricity Industry Participation Code Amendment (Code Review Programme) 2019.

17.115 *[Revoked]*

Clause 17.115: revoked, on 20 December 2021, by clause 160 of the Electricity Industry Participation Code Amendment (Code Review Programme) 2019.

17.116 *[Revoked]*

Clause 17.116: revoked, on 20 December 2021, by clause 161 of the Electricity Industry Participation Code Amendment (Code Review Programme) 2019.

17.117 *[Revoked]*

Clause 17.117: revoked, on 20 December 2021, by clause 162 of the Electricity Industry Participation Code Amendment (Code Review Programme) 2019.

17.118 Development of transmission pricing methodology

The process and guidelines for the development of the transmission pricing methodology last published by the Board under rule 6 of section IV of part F of the **rules** immediately before this Code came into force, are deemed to be the process and guidelines for the development of **transmission pricing methodology** published by the **Authority** under clause 12.83.

17.119 *[Revoked]*

Clause 17.119: revoked, on 20 December 2021, by clause 163 of the Electricity Industry Participation Code Amendment (Code Review Programme) 2019.

17.120 *[Revoked]*

Clause 17.120: revoked, on 20 December 2021, by clause 164 of the Electricity Industry Participation Code Amendment (Code Review Programme) 2019.

17.121 *[Revoked]*

Clause 17.121: revoked, on 20 December 2021, by clause 165 of the Electricity Industry Participation Code Amendment (Code Review Programme) 2019.

17.122 *[Revoked]*

Clause 17.122 revoked, on 20 December 2021, by clause 166 of the Electricity Industry Participation Code Amendment (Code Review Programme) 2019.

17.123 *[Revoked]*

Clause 17.123: revoked, on 20 December 2021, by clause 167 of the Electricity Industry Participation Code Amendment (Code Review Programme) 2019.

17.124 *[Revoked]*

Clause 17.124: revoked, on 20 December 2021, by clause 168 of the Electricity Industry Participation Code Amendment (Code Review Programme) 2019.

17.125 *[Revoked]*

Clause 17.125: revoked, on 20 December 2021, by clause 169 of the Electricity Industry Participation Code Amendment (Code Review Programme) 2019.

17.126 *[Revoked]*

Clause 17.126: revoked, on 20 December 2021, by clause 170 of the Electricity Industry Participation Code Amendment (Code Review Programme) 2019.

17.127 *[Revoked]*

Clause 17.127: revoked, on 20 December 2021, by clause 171 of the Electricity Industry Participation Code Amendment (Code Review Programme) 2019.

Transitional provisions relating to Part 13

17.128 *[Revoked]*

Clause 17.128: revoked, on 20 December 2021, by clause 172 of the Electricity Industry Participation Code Amendment (Code Review Programme) 2019.

17.129 Approval process for industrial co-generating stations

(1) *[Revoked]*

- (2) A generator approved as an industrial co-generating station by the Board under rule 3 of section I or schedule G9 of part G of the **rules**, whose approval had not been rescinded immediately before this Code came into force, is deemed to be a **generator** approved by the **Authority** as an **industrial co-generating station** under clause 13.3 and Schedule 13.4.

(3) *[Revoked]*

Clause 17.129(1) and (3): revoked, on 20 December 2021, by clause 173 of the Electricity Industry Participation Code Amendment (Code Review Programme) 2019.

17.129A *[Revoked]*

Clause 17.129A: inserted, on 27 May 2015, by clause 30 of the Electricity Industry Participation Code Amendment (Industrial Co-generation Dispatch Arrangements) 2015.

Clause 17.129A: revoked, on 20 December 2021, by clause 174 of the Electricity Industry Participation Code Amendment (Code Review Programme) 2019.

17.130 *[Revoked]*

Clause 17.130: revoked, on 20 December 2021, by clause 175 of the Electricity Industry Participation Code Amendment (Code Review Programme) 2019.

17.131 *[Revoked]*

Clause 17.131: revoked, on 20 December 2021, by clause 176 of the Electricity Industry Participation Code Amendment (Code Review Programme) 2019.

17.132 *[Revoked]*

Clause 17.132: revoked, on 20 December 2021, by clause 177 of the Electricity Industry Participation Code Amendment (Code Review Programme) 2019.

17.133 *[Revoked]*

Clause 17.133: revoked, on 20 December 2021, by clause 178 of the Electricity Industry Participation Code Amendment (Code Review Programme) 2019.

17.134 *[Revoked]*

Clause 17.134: revoked, on 20 December 2021, by clause 179 of the Electricity Industry Participation Code Amendment (Code Review Programme) 2019.

17.135 Offers made by unit of plant

Notice given under rule 3.8 of section II of part G of the **rules**, that was in force immediately before this Code came into force, is deemed to be notice given under clause 13.11.

17.136 *[Revoked]*

Clause 17.136: revoked, on 20 December 2021, by clause 180 of the Electricity Industry Participation Code Amendment (Code Review Programme) 2019.

17.137 *[Revoked]*

Clause 17.137: revoked, on 1 March 2024, by clause 130 of the Electricity Industry Participation Code Amendment (Code Review Programme) 2024.

17.138 *[Revoked]*

Clause 17.138: revoked, on 1 March 2024, by clause 131 of the Electricity Industry Participation Code Amendment (Code Review Programme) 2024.

17.139 *[Revoked]*

Clause 17.139: revoked, on 20 December 2021, by clause 181 of the Electricity Industry Participation Code Amendment (Code Review Programme) 2019.

17.140 Retention of bids and offers

The **system operator** must retain records of all bids and offers for electricity submitted by participants and all reserve offers submitted by ancillary service agents under section II of part G of the **rules**, including all revised bids and offers and revised reserve offers, all cancelled bids and offers and all cancelled reserve offers.

17.141 Special treatment of some grid exit points

(1) *[Revoked]*

- (2) 2 or more grid exit points approved to be, or deemed to be approved to be, treated as 1 grid exit point under rule 4 of section II of part G of the **rules** immediately before this Code came into force, are deemed to be approved to be treated as 1 **grid exit point** under clause 13.28.

Clause 17.141(1): revoked, on 20 December 2021, by clause 182 of the Electricity Industry Participation Code Amendment (Code Review Programme) 2019.

17.142 *[Revoked]*

Clause 17.142: revoked, on 20 December 2021, by clause 183 of the Electricity Industry Participation Code Amendment (Code Review Programme) 2019.

17.143 Transmission grid capability information to be updated

The period of time agreed between the system operator and each grid owner for updates to information described in rules 5.1 to 5.3 and rule 5.5 of section II of part G of the **rules** immediately before this Code came into force for the purposes of rule 5.4 of section II of part G of the **rules**, is deemed to be the period of time agreed between the **system operator** and each **grid owner** for updates to information described in clauses 13.29 to 13.31 and 13.33 as the case may be, for the purpose of clause 13.32.

17.144 *[Revoked]*

Clause 17.144: revoked, on 20 December 2021, by clause 184 of the Electricity Industry Participation Code Amendment (Code Review Programme) 2019.

17.145 *[Revoked]*

Clause 17.145: revoked, on 20 December 2021, by clause 185 of the Electricity Industry Participation Code Amendment (Code Review Programme) 2019.

17.146 *[Revoked]*

Clause 17.146: revoked, on 20 December 2021, by clause 186 of the Electricity Industry Participation Code Amendment (Code Review Programme) 2019.

17.147 *[Revoked]*

Clause 17.147: revoked, on 20 December 2021, by clause 187 of the Electricity Industry Participation Code Amendment (Code Review Programme) 2019.

17.148 *[Revoked]*

Clause 17.136: revoked, on 20 December 2021, by clause 188 of the Electricity Industry Participation Code Amendment (Code Review Programme) 2019.

17.149 *[Revoked]*

Clause 17.149: revoked, on 20 December 2021, by clause 189 of the Electricity Industry Participation Code Amendment (Code Review Programme) 2019.

17.150 *[Revoked]*

Clause 17.150: revoked, on 20 December 2021, by clause 190 of the Electricity Industry Participation Code Amendment (Code Review Programme) 2019.

17.151 Block dispatch may occur

- (1) A notification provided to the **system operator** under rules 3.6 to 3.6.2 of section III of part G of the **rules** immediately before this Code came into force, in respect of **trading periods** that occur after this Code came into force, is deemed to be a notification under clause 13.60 in respect of those **trading periods**.
- (2) An agreement or deemed agreement to treat a group of generating stations as a block dispatch group under rule 3.6 of section III of part G of the **rules** that was in force immediately before this Code came into force, is deemed to be an agreement under clause 13.60.

Clause 17.151(1): amended, on 20 December 2021, by clause 191(a) and (b) of the Electricity Industry Participation Code Amendment (Code Review Programme) 2019.

17.152 System operator to notify block security constraints

A notification of block security constraints under rule 3.6.5 of section III of part G of the **rules** immediately before this Code came into force, which applies to **trading periods** after this Code came into force, is deemed to be a notification of **block security constraints** under clause 13.61(1).

17.153 Station dispatch may occur

- (1) A notification given, or deemed by rule 4.2 of section IV of part I of the **rules** to be given, by a generator to the system operator in accordance with rule 3.9 of section III of part G of the **rules** before this Code came into force, which applies to a period after this Code came into force, is deemed to be a notification given under clause 13.64.
- (2) An election notified, or deemed by rule 4.2 of section IV of part I of the **rules** to be notified, by the system operator to a generator and the clearing manager in accordance with rule 3.9 of section III of part G of the **rules** before this Code came into force, which applies to a period after this Code came into force, is deemed to be an election notified under clause 13.64.

17.154 System operator to notify security constraints

A notification of a dispatch made in accordance with rules 3.9.1 and 3.9.2 of section III of part G of the **rules** that was in force immediately before this Code came into force, which applies to a period after this Code came into force, is deemed to be a notice under clause 13.65.

Clause 17.154: amended, on 20 December 2021, by clause 192 of the Electricity Industry Participation Code Amendment (Code Review Programme) 2019.

17.155 Generator notifies change from station to unit dispatch

A notification of a change from a station dispatch group to a generating unit under rule 3.9.3 of section III of part G of the **rules** that was in force immediately before this Code came into force, which applies to a period after this Code came into force, is deemed to be a notification under clause 13.66.

17.156 [Revoked]

Clause 17.156: revoked, on 20 December 2021, by clause 193 of the Electricity Industry Participation Code Amendment (Code Review Programme) 2019.

17.157 [Revoked]

Clause 17.157: revoked, on 20 December 2021, by clause 194 of the Electricity Industry Participation Code Amendment (Code Review Programme) 2019.

17.158 [Revoked]

Clause 17.158: revoked, on 20 December 2021, by clause 195 of the Electricity Industry Participation Code Amendment (Code Review Programme) 2019.

17.159 [Revoked]

Clause 17.159: revoked, on 20 December 2021, by clause 196 of the Electricity Industry Participation Code Amendment (Code Review Programme) 2019.

17.160 [Revoked]

Clause 17.160: revoked, on 20 December 2021, by clause 197 of the Electricity Industry Participation Code

Amendment (Code Review Programme) 2019.

17.161 *[Revoked]*

Clause 17.161: revoked, on 20 December 2021, by clause 198 of the Electricity Industry Participation Code Amendment (Code Review Programme) 2019.

17.162 *[Revoked]*

Clause 17.162: revoked, on 20 December 2021, by clause 199 of the Electricity Industry Participation Code Amendment (Code Review Programme) 2019.

17.163 *[Revoked]*

Clause 17.163: revoked, on 20 December 2021, by clause 200 of the Electricity Industry Participation Code Amendment (Code Review Programme) 2019.

17.164 Clearing manager must conduct auctions

The format specified by the clearing manager for bidding under rule 3.3 of section IV of part G of the **rules** that was in force immediately before this Code came into force, is deemed to be the format for bidding under clause 13.117(3), until further amended.

17.165 *[Revoked]*

Clause 17.165: revoked, on 20 December 2021, by clause 201 of the Electricity Industry Participation Code Amendment (Code Review Programme) 2019.

17.166 *[Revoked]*

Clause 17.166: revoked, on 20 December 2021, by clause 202 of the Electricity Industry Participation Code Amendment (Code Review Programme) 2019.

17.167 *[Revoked]*

Clause 17.167: revoked, on 20 December 2021, by clause 203 of the Electricity Industry Participation Code Amendment (Code Review Programme) 2019.

17.168 *[Revoked]*

Clause 17.168: revoked, on 20 December 2021, by clause 204 of the Electricity Industry Participation Code Amendment (Code Review Programme) 2019.

17.169 *[Revoked]*

Clause 17.169(2): revoked, on 20 December 2021, by clause 205 of the Electricity Industry Participation Code Amendment (Code Review Programme) 2019.

Clause 17.169: revoked, on 1 March 2024, by clause 132 of the Electricity Industry Participation Code Amendment (Code Review Programme) 2024.

17.170 *[Revoked]*

Clause 17.170 revoked, on 20 December 2021, by clause 206 of the Electricity Industry Participation Code Amendment (Code Review Programme) 2019.

17.171 *[Revoked]*

Clause 17.171: revoked, on 20 December 2021, by clause 207 of the Electricity Industry Participation Code Amendment (Code Review Programme) 2019.

17.172 *[Revoked]*

Clause 17.172: revoked, on 20 December 2021, by clause 208 of the Electricity Industry Participation Code Amendment (Code Review Programme) 2019.

17.173 *[Revoked]*

Clause 17.173: revoked, on 20 December 2021, by clause 209 of the Electricity Industry Participation Code Amendment (Code Review Programme) 2019.

17.174 *[Revoked]*

Clause 17.174: revoked, on 20 December 2021, by clause 210 of the Electricity Industry Participation Code Amendment (Code Review Programme) 2019.

17.175 *[Revoked]*

Clause 17.175: revoked, on 20 December 2021, by clause 211 of the Electricity Industry Participation Code Amendment (Code Review Programme) 2019.

17.176 *[Revoked]*

Clause 17.176: revoked, on 20 December 2021, by clause 212 of the Electricity Industry Participation Code Amendment (Code Review Programme) 2019.

17.177 *[Revoked]*

Clause 17.177(4): amended, on 21 September 2012, by clause 41(1) of the Electricity Industry Participation (Minor Amendments) Code Amendment 2012.

Clause 17.177(5): amended, on 21 September 2012, by clause 41(2) of the Electricity Industry Participation (Minor Amendments) Code Amendment 2012.

Clause 17.177: revoked, on 20 December 2021, by clause 213 of the Electricity Industry Participation Code Amendment (Code Review Programme) 2019.

17.178 *[Revoked]*

Clause 17.178: revoked, on 20 December 2021, by clause 214 of the Electricity Industry Participation Code Amendment (Code Review Programme) 2019.

17.179 *[Revoked]*

Clause 17.179: revoked, on 20 December 2021, by clause 215 of the Electricity Industry Participation Code Amendment (Code Review Programme) 2019.

17.180 *[Revoked]*

Clause 17.180: revoked, on 20 December 2021, by clause 216 of the Electricity Industry Participation Code Amendment (Code Review Programme) 2019.

17.181 *[Revoked]*

Clause 17.181: revoked, on 20 December 2021, by clause 217 of the Electricity Industry Participation Code Amendment (Code Review Programme) 2019.

17.182 *[Revoked]*

Clause 17.182: revoked, on 20 December 2021, by clause 218 of the Electricity Industry Participation Code Amendment (Code Review Programme) 2019.

17.183 *[Revoked]*

Clause 17.183: revoked, on 20 December 2021, by clause 219 of the Electricity Industry Participation Code Amendment (Code Review Programme) 2019.

17.184 *[Revoked]*

Clause 17.184: revoked, on 1 March 2024, by clause 133 of the Electricity Industry Participation Code Amendment (Code Review Programme) 2024.

17.185 [Revoked]

Clause 17.185: revoked, on 20 December 2021, by clause 220 of the Electricity Industry Participation Code Amendment (Code Review Programme) 2019.

17.186 [Revoked]

Clause 17.186: revoked, on 20 December 2021, by clause 221 of the Electricity Industry Participation Code Amendment (Code Review Programme) 2019.

17.187 [Revoked]

Clause 17.187: revoked, on 20 December 2021, by clause 222 of the Electricity Industry Participation Code Amendment (Code Review Programme) 2019.

17.188 [Revoked]

Clause 17.188: revoked, on 20 December 2021, by clause 223 of the Electricity Industry Participation Code Amendment (Code Review Programme) 2019.

17.189 [Revoked]

Clause 17.189: revoked, on 20 December 2021, by clause 224 of the Electricity Industry Participation Code Amendment (Code Review Programme) 2019.

17.190 [Revoked]

Clause 17.190: revoked, on 20 December 2021, by clause 225 of the Electricity Industry Participation Code Amendment (Code Review Programme) 2019.

17.191 Information that must be submitted

The form specified by the Board for submission of information under rule 3 of section VI of part G of the **rules** immediately before this Code came into force, is deemed to be the form specified by the **Authority** under clause 13.219.

17.192 Calculation of contract price

Guidelines issued by the Board under rule 4 of section VI of part G of the **rules** and in force immediately before this Code came into force, are deemed to be guidelines issued by the **Authority** under clause 13.220.

17.193 Information submitted

Information submitted under rules 3, 7 and 8 of section VI of part of G of the **rules** immediately before this Code came into force, is deemed to be information submitted under clauses 13.219, 13.223, and 13.224 respectively.

17.194 Timeframes for submitting that information

Information submitted in accordance with rule 9 of section VI of part G of the **rules** immediately before this Code came into force, is deemed to be information submitted under clause 13.225.

Transitional provisions relating to Part 14

17.195 Acceptable forms of security

- (1) A cash deposit paid under rule 2.4.1 of part H of the **rules** before this Code came into force, is deemed to be a **cash deposit** paid under clause 14.5(a).

- (2) A security agreement provided and maintained under rule 2.4.1 of part H of the **rules** immediately before this Code came into force, is deemed to be a security agreement provided and maintained under clause 14.5(a).
- (3) An unconditional guarantee or letter of credit provided and maintained under rule 2.4.2 of part H of the **rules** immediately before this Code came into force, is deemed to be an unconditional guarantee or letter of credit provided and maintained under clause 14.5(b).
- (4) An unconditional third party guarantee provided and maintained under rule 2.4.3 of part H of the **rules** immediately before this Code came into force, is deemed to be an unconditional third party guarantee provided and maintained under clause 14.5(c).
- (5) A security bond provided and maintained under rule 2.4.4 of part H of the **rules** immediately before this Code came into force, is deemed to be a security bond provided and maintained under clause 14.5(d).
- (6) A hedge settlement agreement lodged under rule 2.4.5 of part H of the **rules** immediately before this Code came into force, is deemed to be a **hedge settlement agreement** lodged under clause 14.5(e).
- (7) If the terms of a security were approved by the Commission under rule 2.4 of part H of the **rules** immediately before this Code came into force, those terms are deemed to be approved by the **Authority** under clause 14.5.

17.196 Cash deposits

- (1) A cash deposit account established under rule 2.6.1 of part H of the **rules** immediately before this Code came into force, is deemed to be a **cash deposit account** established under clause 14.7(1).
- (2) An acknowledgment obtained under rule 2.6.3 of part H of the **rules** immediately before this Code came into force, is deemed to be an acknowledgment obtained under clause 14.7(3).
- (3) A cash deposit received under rule 2.6.4 of part H of the **rules** immediately before this Code came into force, is deemed to be a **cash deposit** received under clause 14.8, and must be paid accordingly.
- (4) *[Revoked]*
- (5) *[Revoked]*

Clause 17.196(4) and (5): revoked, on 20 December 2021, by clause 226 of the Electricity Industry Participation Code Amendment (Code Review Programme) 2019.

17.197 *[Revoked]*

Clause 17.197: revoked, on 20 December 2021, by clause 227 of the Electricity Industry Participation Code Amendment (Code Review Programme) 2019.

17.198 *[Revoked]*

Clause 17.198: revoked, on 20 December 2021, by clause 228 of the Electricity Industry Participation Code Amendment (Code Review Programme) 2019.

17.199 *[Revoked]*

Clause 17.199: revoked, on 20 December 2021, by clause 229 of the Electricity Industry Participation Code Amendment (Code Review Programme) 2019.

17.200 *[Revoked]*

Clause 17.200: revoked, on 20 December 2021, by clause 230 of the Electricity Industry Participation Code Amendment (Code Review Programme) 2019.

17.201 [Revoked]

Clause 17.201: revoked, on 20 December 2021, by clause 231 of the Electricity Industry Participation Code Amendment (Code Review Programme) 2019.

17.202 [Revoked]

Clause 17.202: revoked, on 20 December 2021, by clause 232 of the Electricity Industry Participation Code Amendment (Code Review Programme) 2019.

17.203 [Revoked]

Clause 17.203: revoked, on 20 December 2021, by clause 233 of the Electricity Industry Participation Code Amendment (Code Review Programme) 2019.

17.204 [Revoked]

Clause 17.204: revoked, on 20 December 2021, by clause 234 of the Electricity Industry Participation Code Amendment (Code Review Programme) 2019.

17.205 Operating account

- (1) An operating account established under rule 7.11 of part H of the **rules** immediately before this Code came into force, is deemed to be an **operating account** established under clause 14.43(1).
- (2) An acknowledgment obtained under rule 7.12 of part H of the **rules** immediately before this Code came into force, is deemed to be an acknowledgment obtained under clause 14.43(2).

17.206 [Revoked]

Clause 17.206: revoked, on 20 December 2021, by clause 235 of the Electricity Industry Participation Code Amendment (Code Review Programme) 2019.

17.207 [Revoked]

Clause 17.207: revoked, on 20 December 2021, by clause 236 of the Electricity Industry Participation Code Amendment (Code Review Programme) 2019.

17.208 [Revoked]

Clause 17.208: revoked, on 20 December 2021, by clause 237 of the Electricity Industry Participation Code Amendment (Code Review Programme) 2019.

17.209 [Revoked]

Clause 17.209: revoked, on 20 December 2021, by clause 238 of the Electricity Industry Participation Code Amendment (Code Review Programme) 2019.

17.210 [Revoked]

Clause 17.210: revoked, on 20 December 2021, by clause 239 of the Electricity Industry Participation Code Amendment (Code Review Programme) 2019.

17.210A [Revoked]

Clause 17.210A: inserted, on 24 March 2015, by clause 28 of the Electricity Industry Participation (Settlement and Prudential Security) Code Amendment 2013.

Clause 17.210A: revoked, on 5 October 2017, by clause 582 of the Electricity Industry Participation Code Amendment (Code Review Programme) 2017.

17.210B *[Revoked]*

Clause 17.210B: inserted, on 24 March 2015, by clause 28 of the Electricity Industry Participation (Settlement and Prudential Security) Code Amendment 2013.

Clause 17.210B: revoked, on 5 October 2017, by clause 582 of the Electricity Industry Participation Code Amendment (Code Review Programme) 2017.

17.210C *[Revoked]*

Clause 17.210C: inserted, on 24 March 2015, by clause 28 of the Electricity Industry Participation (Settlement and Prudential Security) Code Amendment 2013.

Clause 17.210C: revoked, on 5 October 2017, by clause 582 of the Electricity Industry Participation Code Amendment (Code Review Programme) 2017.

17.210D *[Revoked]*

Clause 17.210D: inserted, on 24 March 2015, by clause 28 of the Electricity Industry Participation (Settlement and Prudential Security) Code Amendment 2013.

Clause 17.210D: revoked, on 5 October 2017, by clause 582 of the Electricity Industry Participation Code Amendment (Code Review Programme) 2017.

17.210E *[Revoked]*

Clause 17.210E: inserted, on 24 March 2015, by clause 28 of the Electricity Industry Participation (Settlement and Prudential Security) Code Amendment 2013.

Clause 17.210E: revoked, on 5 October 2017, by clause 582 of the Electricity Industry Participation Code Amendment (Code Review Programme) 2017.

17.210F *[Revoked]*

Clause 17.210F: inserted, on 24 March 2015, by clause 28 of the Electricity Industry Participation (Settlement and Prudential Security) Code Amendment 2013.

Clause 17.210F: revoked, on 5 October 2017, by clause 582 of the Electricity Industry Participation Code Amendment (Code Review Programme) 2017.

17.210G *[Revoked]*

Clause 17.210G: inserted, on 24 March 2015, by clause 28 of the Electricity Industry Participation (Settlement and Prudential Security) Code Amendment 2013.

Clause 17.210G: revoked, on 5 October 2017, by clause 582 of the Electricity Industry Participation Code Amendment (Code Review Programme) 2017.

17.210H *[Revoked]*

Clause 17.210H: inserted, on 24 March 2015, by clause 28 of the Electricity Industry Participation (Settlement and Prudential Security) Code Amendment 2013.

Clause 17.210H: revoked, on 5 October 2017, by clause 582 of the Electricity Industry Participation Code Amendment (Code Review Programme) 2017.

17.210I *[Revoked]*

Clause 17.210I: inserted, on 24 March 2015, by clause 28 of the Electricity Industry Participation (Settlement and Prudential Security) Code Amendment 2013.

Clause 17.210I: revoked, on 5 October 2017, by clause 582 of the Electricity Industry Participation Code Amendment (Code Review Programme) 2017.

17.210J *[Revoked]*

Clause 17.210J: inserted, on 24 March 2015, by clause 28 of the Electricity Industry Participation (Settlement and Prudential Security) Code Amendment 2013.

Clause 17.210J: revoked, on 5 October 2017, by clause 582 of the Electricity Industry Participation Code Amendment (Code Review Programme) 2017.

17.210K *[Revoked]*

Clause 17.210K: inserted, on 24 March 2015, by clause 28 of the Electricity Industry Participation (Settlement and Prudential Security) Code Amendment 2013.

Clause 17.210K: revoked, on 5 October 2017, by clause 582 of the Electricity Industry Participation Code Amendment (Code Review Programme) 2017.

17.210L *[Revoked]*

Clause 17.210L: inserted, on 24 March 2015, by clause 28 of the Electricity Industry Participation (Settlement and Prudential Security) Code Amendment 2013.

Clause 17.210L(2) and (3): inserted, on 24 March 2015, by clause 27 of the Electricity Industry Participation Code Amendment (Settlement and Prudential Security) 2014.

Clause 17.210L: revoked, on 5 October 2017, by clause 582 of the Electricity Industry Participation Code Amendment (Code Review Programme) 2017.

17.210M *[Revoked]*

Clause 17.210M: inserted, on 24 March 2015, by clause 28 of the Electricity Industry Participation (Settlement and Prudential Security) Code Amendment 2013.

Clause 17.210M: revoked, on 5 October 2017, by clause 582 of the Electricity Industry Participation Code Amendment (Code Review Programme) 2017.

17.210N *[Revoked]*

Clause 17.210N: inserted, on 24 March 2015, by clause 28 of the Electricity Industry Participation (Settlement and Prudential Security) Code Amendment 2013.

Clause 17.210N: revoked, on 5 October 2017, by clause 582 of the Electricity Industry Participation Code Amendment (Code Review Programme) 2017.

17.210O *[Revoked]*

Clause 17.210O: inserted, on 24 March 2015, by clause 28 of the Electricity Industry Participation (Settlement and Prudential Security) Code Amendment 2013.

Clause 17.210O: revoked, on 5 October 2017, by clause 582 of the Electricity Industry Participation Code Amendment (Code Review Programme) 2017.

Transitional provisions relating to Part 15

17.211 *[Revoked]*

Clause 17.211: revoked, on 20 December 2021, by clause 240 of the Electricity Industry Participation Code Amendment (Code Review Programme) 2019.

17.212 *[Revoked]*

Clause 17.212: revoked, on 20 December 2021, by clause 241 of the Electricity Industry Participation Code Amendment (Code Review Programme) 2019.

17.213 *[Revoked]*

Clause 17.213: revoked, on 20 December 2021, by clause 242 of the Electricity Industry Participation Code Amendment (Code Review Programme) 2019.

17.214 *[Revoked]*

Clause 17.214: revoked, on 20 December 2021, by clause 243 of the Electricity Industry Participation Code Amendment (Code Review Programme) 2019.

17.215 *[Revoked]*

Clause 17.215: revoked, on 20 December 2021, by clause 244 of the Electricity Industry Participation Code Amendment (Code Review Programme) 2019.

17.216 *[Revoked]*

Clause 17.216: revoked, on 20 December 2021, by clause 245 of the Electricity Industry Participation Code Amendment (Code Review Programme) 2019.

17.217 *[Revoked]*

Clause 17.217: revoked, on 20 December 2021, by clause 246 of the Electricity Industry Participation Code Amendment (Code Review Programme) 2019.

17.218 *[Revoked]*

Clause 17.218: revoked, on 20 December 2021, by clause 247 of the Electricity Industry Participation Code Amendment (Code Review Programme) 2019.

17.219 *[Revoked]*

Clause 17.219: revoked, on 20 December 2021, by clause 248 of the Electricity Industry Participation Code Amendment (Code Review Programme) 2019.

17.220 *[Revoked]*

Clause 17.220: revoked, on 20 December 2021, by clause 249 of the Electricity Industry Participation Code Amendment (Code Review Programme) 2019.

17.221 Notification by embedded generators

A notification given by an embedded generator to the reconciliation manager under rule 4A of part J of the **rules** that was in force immediately before this Code came into force, is deemed to be a notification given under clause 15.13.

17.222 Notification of changes to the grid

(1) *[Revoked]*

(2) Procedures or other requirements specified by the reconciliation manager under rule 5 of part J of the **rules** that were in force immediately before this Code came into force, are deemed to be procedures or other requirements, as the case may be, specified under clause 15.14(1).

(3) *[Revoked]*

(4) *[Revoked]*

Clause 17.222(1), (3) and (4): revoked, on 20 December 2021, by clause 250 of the Electricity Industry Participation Code Amendment (Code Review Programme) 2019.

17.223 *[Revoked]*

Clause 17.223: revoked, on 20 December 2021, by clause 251 of the Electricity Industry Participation Code Amendment (Code Review Programme) 2019.

17.224 *[Revoked]*

Clause 17.224: revoked, on 20 December 2021, by clause 252 of the Electricity Industry Participation Code Amendment (Code Review Programme) 2019.

17.225 *[Revoked]*

Clause 17.225: revoked, on 20 December 2021, by clause 253 of the Electricity Industry Participation Code Amendment (Code Review Programme) 2019.

17.226 *[Revoked]*

Clause 17.226: revoked, on 20 December 2021, by clause 254 of the Electricity Industry Participation Code Amendment (Code Review Programme) 2019.

17.227 [Revoked]

Clause 17.227: revoked, on 20 December 2021, by clause 255 of the Electricity Industry Participation Code Amendment (Code Review Programme) 2019.

17.228 [Revoked]

Clause 17.228: revoked, on 20 December 2021, by clause 256 of the Electricity Industry Participation Code Amendment (Code Review Programme) 2019.

17.229 [Revoked]

Clause 17.229: revoked, on 20 December 2021, by clause 257 of the Electricity Industry Participation Code Amendment (Code Review Programme) 2019.

17.230 [Revoked]

Clause 17.230: revoked, on 20 December 2021, by clause 258 of the Electricity Industry Participation Code Amendment (Code Review Programme) 2019.

17.231 [Revoked]

Clause 17.231: revoked, on 20 December 2021, by clause 259 of the Electricity Industry Participation Code Amendment (Code Review Programme) 2019.

17.232 [Revoked]

Clause 17.232: revoked, on 20 December 2021, by clause 260 of the Electricity Industry Participation Code Amendment (Code Review Programme) 2019.

17.233 [Revoked]

Clause 17.233: revoked, on 20 December 2021, by clause 261 of the Electricity Industry Participation Code Amendment (Code Review Programme) 2019.

17.234 [Revoked]

Clause 17.234: revoked, on 20 December 2021, by clause 262 of the Electricity Industry Participation Code Amendment (Code Review Programme) 2019.

17.235 [Revoked]

Clause 17.235: revoked, on 20 December 2021, by clause 263 of the Electricity Industry Participation Code Amendment (Code Review Programme) 2019.

17.236 [Revoked]

Clause 17.236: revoked, on 20 December 2021, by clause 264 of the Electricity Industry Participation Code Amendment (Code Review Programme) 2019.

17.237 [Revoked]

Clause 17.237: revoked, on 20 December 2021, by clause 265 of the Electricity Industry Participation Code Amendment (Code Review Programme) 2019.

17.238 [Revoked]

Clause 17.238: revoked, on 20 December 2021, by clause 266 of the Electricity Industry Participation Code Amendment (Code Review Programme) 2019.

17.239 [Revoked]

Clause 17.239: revoked, on 20 December 2021, by clause 267 of the Electricity Industry Participation Code Amendment (Code Review Programme) 2019.

17.240 [Revoked]

Clause 17.240: revoked, on 20 December 2021, by clause 268 of the Electricity Industry Participation Code

Amendment (Code Review Programme) 2019.

17.241 *[Revoked]*

Clause 17.241: revoked, on 20 December 2021, by clause 269 of the Electricity Industry Participation Code Amendment (Code Review Programme) 2019.

17.242 Participant must use participant identifiers

- (1) For the purpose of clause 15.39, a participant identifier obtained by a participant under the **rules** before this Code came into force, is deemed to be the **participant identifier** for that **participant** under this Code.
- (2) *[Revoked]*
- (3) A notification given by the Board under rule 20.3 of part J of the **rules** before this Code came into force, is deemed to be a notification given by the **Authority** under clause 15.39(3).

Clause 17.242(2): revoked, on 20 December 2021, by clause 270 of the Electricity Industry Participation Code Amendment (Code Review Programme) 2019.

17.243 *[Revoked]*

Clause 17.243: revoked, on 20 December 2021, by clause 271 of the Electricity Industry Participation Code Amendment (Code Review Programme) 2019.

17.244 *[Revoked]*

Clause 17.244: revoked, on 20 December 2021, by clause 272 of the Electricity Industry Participation Code Amendment (Code Review Programme) 2019.

17.245 *[Revoked]*

Clause 17.245: revoked, on 20 December 2021, by clause 273 of the Electricity Industry Participation Code Amendment (Code Review Programme) 2019.

17.246 *[Revoked]*

Clause 17.246: revoked, on 20 December 2021, by clause 274 of the Electricity Industry Participation Code Amendment (Code Review Programme) 2019.

17.247 *[Revoked]*

Clause 17.247: revoked, on 20 December 2021, by clause 275 of the Electricity Industry Participation Code Amendment (Code Review Programme) 2019.

17.248 *[Revoked]*

Clause 17.248: revoked, on 20 December 2021, by clause 276 of the Electricity Industry Participation Code Amendment (Code Review Programme) 2019.

17.249 *[Revoked]*

Clause 17.249: revoked, on 20 December 2021, by clause 277 of the Electricity Industry Participation Code Amendment (Code Review Programme) 2019.

17.250 *[Revoked]*

Clause 17.250: revoked, on 20 December 2021, by clause 278 of the Electricity Industry Participation Code Amendment (Code Review Programme) 2019.

17.251 *[Revoked]*

Clause 17.251: revoked, on 20 December 2021, by clause 279 of the Electricity Industry Participation Code Amendment (Code Review Programme) 2019.

17.252 [Revoked]

Clause 17.252: revoked, on 20 December 2021, by clause 280 of the Electricity Industry Participation Code Amendment (Code Review Programme) 2019.

17.253 [Revoked]

Clause 17.253: revoked, on 20 December 2021, by clause 281 of the Electricity Industry Participation Code Amendment (Code Review Programme) 2019.

17.254 [Revoked]

Clause 17.254: revoked, on 20 December 2021, by clause 282 of the Electricity Industry Participation Code Amendment (Code Review Programme) 2019.

17.255 [Revoked]

Clause 17.255: revoked, on 20 December 2021, by clause 283 of the Electricity Industry Participation Code Amendment (Code Review Programme) 2019.

17.256 [Revoked]

Clause 17.256: revoked, on 20 December 2021, by clause 284 of the Electricity Industry Participation Code Amendment (Code Review Programme) 2019.

17.257 [Revoked]

Clause 17.257: revoked, on 20 December 2021, by clause 285 of the Electricity Industry Participation Code Amendment (Code Review Programme) 2019.

17.258 [Revoked]

Clause 17.258: revoked, on 20 December 2021, by clause 286 of the Electricity Industry Participation Code Amendment (Code Review Programme) 2019.

17.259 [Revoked]

Clause 17.259: revoked, on 20 December 2021, by clause 287 of the Electricity Industry Participation Code Amendment (Code Review Programme) 2019.

17.260 [Revoked]

Clause 17.260: revoked, on 20 December 2021, by clause 288 of the Electricity Industry Participation Code Amendment (Code Review Programme) 2019.

17.261 [Revoked]

Clause 17.261: revoked, on 20 December 2021, by clause 289 of the Electricity Industry Participation Code Amendment (Code Review Programme) 2019.

17.262 Meter interrogation for half-hour metering

(1) *[Revoked]*

- (2) A percentage specified by the Board under clause 6.5 of schedule J2 of part J of the **rules** that was in force immediately before this Code came into force, is deemed to be a percentage specified by the **Authority** under clause 15(2) of Schedule 15.2.

Clause 17.262(1): revoked, on 20 December 2021, by clause 290 of the Electricity Industry Participation Code Amendment (Code Review Programme) 2019.

17.263 Audit trails

Information provided to and received from the registry, provided to and received from the **reconciliation manager**, or provided to and received from other reconciliation participants and their agents under clause 11.1 of schedule J2 of part J of the **rules** immediately before this Code came into force, is deemed to be information provided to

and received from the **registry**, provided to and received from the **reconciliation manager**, or provided and received from other **reconciliation participants** and their agents, as the case may be, under clause 21(2).

17.264 Correction of meter readings

A journal generated and archived by a reconciliation participant under clause 11.4.2 of schedule J2 of part J of the **rules** before this Code came into force, is deemed to be a journal generated and archived under clause 22(2) of Schedule 15.2.

17.265 Creation of submission information

(1) *[Revoked]*

(2) A percentage specified and published by the Board under clause 2.2.3 of schedule J3 of part J of the **rules** that was in force immediately before this Code came into force, is deemed to be a percentage specified and published, as the case may be, by the **Authority** under clause 6(3) of Schedule 15.3.

Clause 17.265(1): revoked, on 20 December 2021, by clause 291 of the Electricity Industry Participation Code Amendment (Code Review Programme) 2019.

17.266 *[Revoked]*

Clause 17.266: revoked, on 20 December 2021, by clause 292 of the Electricity Industry Participation Code Amendment (Code Review Programme) 2019.

17.267 *[Revoked]*

Clause 17.267: revoked, on 20 December 2021, by clause 293 of the Electricity Industry Participation Code Amendment (Code Review Programme) 2019.

17.268 Distributed unmetered load database

A database maintained by a retailer in accordance with clause 5 of schedule J3 of part J of the **rules** before this Code came into force, is deemed to be a database maintained by that **retailer** under clause 11 of Schedule 15.3.

17.269 Calculation by difference for embedded networks

A notice given by a trader to the reconciliation manager designating an ICP under clause 3 of schedule J4 of part J of the **rules** that had not been revoked immediately before this Code came into force, is deemed to be a notice given under clause 3 of Schedule 15.4.

17.270 Calculation by difference for local networks

(1) *[Revoked]*

(2) A designation granted by the Board under clause 3A of schedule J4 of part J of the **rules** that had not been revoked by the Board immediately before this Code came into force, is deemed to be a designation granted by the **Authority** under clause 4 of Schedule 15.4.

Clause 17.270(1): revoked, on 20 December 2021, by clause 294 of the Electricity Industry Participation Code Amendment (Code Review Programme) 2019.

17.271 ICP days information

The default values for profiles and loss category codes determined by the Board under clause 4.2.2 of schedule J4 of part J of the **rules** that were in force immediately before

this Code came into force, are deemed to be default values for **profiles** and **loss category** codes, as the case may be, determined by the **Authority** under clause 7(5) of Schedule 15.4.

17.272 *[Revoked]*

Clause 17.272: revoked, on 20 December 2021, by clause 295 of the Electricity Industry Participation Code Amendment (Code Review Programme) 2019.

17.273 Convert non half-hour quantities using profiles

- (1) A notification given by a profile owner to the reconciliation manager under clause 6.1.2 of schedule J4 of part J of the **rules** that was in force immediately before this Code came into force, is deemed to be a notification given under clause 10(b) of Schedule 15.4.
- (2) A authorisation given by a profile owner to a reconciliation participant under clause 6.1.3 of part J of the **rules** that was in force immediately before this Code came into force, is deemed to be an authorisation given under clause 10(c) of Schedule 15.4.

17.274 Invalid submission information

Default values specified by the Board under clause 6.5.2 of schedule J4 of part J of the **rules** that were in force immediately before this Code came into force, are deemed to be default values specified by the **Authority** under clause 14(b) of Schedule 15.4.

17.275 *[Revoked]*

Clause 17.275: revoked, on 20 December 2021, by clause 296 of the Electricity Industry Participation Code Amendment (Code Review Programme) 2019.

17.276 *[Revoked]*

Clause 17.276: revoked, on 20 December 2021, by clause 297 of the Electricity Industry Participation Code Amendment (Code Review Programme) 2019.

17.277 *[Revoked]*

Clause 17.277: revoked, on 20 December 2021, by clause 298 of the Electricity Industry Participation Code Amendment (Code Review Programme) 2019.

17.278 *[Revoked]*

Clause 17.278: revoked, on 20 December 2021, by clause 299 of the Electricity Industry Participation Code Amendment (Code Review Programme) 2019.

17.279 *[Revoked]*

Clause 17.279: revoked, on 20 December 2021, by clause 300 of the Electricity Industry Participation Code Amendment (Code Review Programme) 2019.

17.280 Provision of reconciliation information

- (1) *[Revoked]*
- (2) A format or information requirement determined by the Board under clause 15 of schedule J4 of part J of the **rules** that was in force before this Code came into force, is deemed to be a format or information requirement, as the case may be, determined by the **Authority** under clause 28 of Schedule 15.4.

Clause 17.280(1): revoked, on 20 December 2021, by clause 301 of the Electricity Industry Participation Code Amendment (Code Review Programme) 2019.

17.281 Departure from requirements for profile administration

An approval given by the market administrator under clause 2 of schedule J5 of part J of the **rules** that was in force immediately before this Code came into force, is deemed to be an approval given under clause 2 of Schedule 15.5.

17.282 Profile population list

A profile population list kept by a reconciliation participant under clause 3.3 of schedule J5 of part J of the **rules** immediately before this Code came into force, is deemed to be a **profile population** list kept under clause 5 under Schedule 15.5.

17.283 Profiles approved for use

Details kept by a profile owner under clause 3.4 of schedule J5 of part J of the **rules** immediately before this Code came into force, are deemed to be details kept under clause 6 of Schedule 15.5.

17.284 *[Revoked]*

Clause 17.284: revoked, on 20 December 2021, by clause 302 of the Electricity Industry Participation Code Amendment (Code Review Programme) 2019.

17.285 Profile codes

(1) A profile code determined by the market administrator under clause 5 of schedule J5 of part J of the **rules** that was in force immediately before this Code came into force, is deemed to be a **profile code** determined under clause 13 of Schedule 15.5.

(2) *[Revoked]*

Clause 17.285(2): revoked, on 20 December 2021, by clause 303 of the Electricity Industry Participation Code Amendment (Code Review Programme) 2019.

17.286 New NSP derived profiles

(1) *[Revoked]*

(2) *[Revoked]*

(3) A legal entity nominated by a profile applicant under clause 7.3 of schedule J5 of part J of the **rules** immediately before this Code came into force, is deemed to be a legal entity nominated under clause 21 of Schedule 15.5.

(4) *[Revoked]*

(5) A profile approved by the market administrator under clause 7 of schedule J5 of part J of the **rules** that was in force immediately before this Code came into force, is deemed to be a **profile** approved by the **market administrator** under clauses 19 to 24, as the case may be, of Schedule 15.5.

(6) An approval given by a profile owner to a reconciliation participant under clause 7.6 of schedule J5 of part J of the **rules** that was in force immediately before this Code came into force, is deemed to be an approval given under clause 24(2) of Schedule 15.5.

Clause 17.286(1), (2) and (4): revoked, on 20 December 2021, by clause 304 of the Electricity Industry Participation Code Amendment (Code Review Programme) 2019.

17.287 New statistically sampled/engineered profiles

(1) *[Revoked]*

(2) *[Revoked]*

(3) *[Revoked]*

- (4) A legal entity nominated to be the profile owner under clause 8.5 of schedule J5 of part J of the **rules** immediately before this Code came into force, is deemed to be a legal entity nominated under clause 29 of Schedule 15.5.
 - (5) *[Revoked]*
 - (6) *[Revoked]*
 - (7) A date decided by the market administrator under clause 8.8 of schedule J5 of part J of the **rules** immediately before this Code came into force, is deemed to be a date decided under clause 32(1) of Schedule 15.5.
 - (8) An approval given by a profile owner to a reconciliation participant under clause 8.8 of schedule J5 of part J of the **rules** that was in force immediately before this Code came into force, is deemed to be an approval given under clause 32(2) of Schedule 15.5.
 - (9) A profile population list maintained by a profile owner under clause 8.9 of schedule J5 of part J of the **rules** immediately before this Code came into force, is deemed to be a **profile population** list maintained under clause 33 of Schedule 15.5.
 - (10) *[Revoked]*
 - (11) *[Revoked]*
 - (12) *[Revoked]*
- Clause 17.287(1), (2) and (3): revoked, on 20 December 2021, by clause 305(1) of the Electricity Industry Participation Code Amendment (Code Review Programme) 2019.
Clause 17.287(5) and (6): revoked, on 20 December 2021, by clause 305(2) of the Electricity Industry Participation Code Amendment (Code Review Programme) 2019.
Clause 17.287(10), (11) and (12): revoked, on 20 December 2021, by clause 305(3) of the Electricity Industry Participation Code Amendment (Code Review Programme) 2019.

17.288 MARIA profiles

A profile deemed, in accordance with rule 4 of section III of part I of the **rules** to be a profile determined under rules 6.1 and 7.2 of code of practice G2 of schedule G8 of part G of the **rules**, is deemed to be a **profile** approved in accordance with clauses 19 to 34, as the case may be, of Schedule 15.5.

17.289 *[Revoked]*

Clause 17.289: revoked, on 20 December 2021, by clause 306 of the Electricity Industry Participation Code Amendment (Code Review Programme) 2019.

17.290 *[Revoked]*

Clause 17.290: revoked, on 20 December 2021, by clause 307 of the Electricity Industry Participation Code Amendment (Code Review Programme) 2019.

17.291 *[Revoked]*

Transitional provisions relating to Part 16 cross-heading: revoked on 16 December 2013, by clause 11(1) of the Electricity Industry Participation (Revocation of Part 16) Code Amendment 2013.
Clause 17.291: revoked, on 20 December 2021, by clause 308 of the Electricity Industry Participation Code Amendment (Code Review Programme) 2019.

17.292 *[Revoked]*

Clause 17.292: revoked on 16 December 2013, by clause 11(2) of the Electricity Industry Participation (Revocation of Part 16) Code Amendment 2013.

17.293 [Revoked]

Clause 17.293: revoked on 16 December 2013, by clause 11(3) of the Electricity Industry Participation (Revocation of Part 16) Code Amendment 2013.

17.294 [Revoked]

Clause 17.294: revoked on 16 December 2013, by clause 11(2) of the Electricity Industry Participation (Revocation of Part 16) Code Amendment 2013.

17.295 [Revoked]

Clause 17.295: revoked on 16 December 2013, by clause 11(2) of the Electricity Industry Participation (Revocation of Part 16) Code Amendment 2013.

Transitional provisions relating to Part 16A

Cross Heading: inserted on 1 June 2017, by clause 37 of the Electricity Industry Participation Code Amendment (Requirements and Processes for Audits) 2016.

17.295A [Revoked]

Clause 17.295A: inserted on 1 June 2017, by clause 37 of the Electricity Industry Participation Code Amendment (Requirements and Processes for Audits) 2016.
Clause 17.295A: revoked, on 20 December 2021, by clause 309 of the Electricity Industry Participation Code Amendment (Code Review Programme) 2019.

17.295B [Revoked]

Clause 17.295B: inserted on 1 June 2017, by clause 37 of the Electricity Industry Participation Code Amendment (Requirements and Processes for Audits) 2016.
Clause 17.295B: revoked, on 20 December 2021, by clause 310 of the Electricity Industry Participation Code Amendment (Code Review Programme) 2019.

17.295C [Revoked]

Clause 17.295C: inserted on 1 June 2017, by clause 37 of the Electricity Industry Participation Code Amendment (Requirements and Processes for Audits) 2016.
Clause 17.295C: revoked, on 20 December 2021, by clause 311 of the Electricity Industry Participation Code Amendment (Code Review Programme) 2019.

17.295D [Revoked]

Clause 17.295D: inserted on 1 June 2017, by clause 37 of the Electricity Industry Participation Code Amendment (Requirements and Processes for Audits) 2016.
Clause 17.295D: revoked, on 20 December 2021, by clause 312 of the Electricity Industry Participation Code Amendment (Code Review Programme) 2019.

17.295E [Revoked]

Clause 17.295E: inserted on 1 June 2017, by clause 37 of the Electricity Industry Participation Code Amendment (Requirements and Processes for Audits) 2016.
Clause 17.295E: revoked, on 20 December 2021, by clause 313 of the Electricity Industry Participation Code Amendment (Code Review Programme) 2019.

17.295F [Revoked]

Clause 17.295F: inserted on 1 June 2017, by clause 37 of the Electricity Industry Participation Code Amendment (Requirements and Processes for Audits) 2016.
Clause 17.295F(1): amended, on 5 October 2017, by clause 583 of the Electricity Industry Participation Code Amendment (Code Review Programme) 2017.
Clause 17.295F: revoked, on 20 December 2021, by clause 314 of the Electricity Industry Participation Code Amendment (Code Review Programme) 2019.

Transitional provisions relating to exemptions

17.296 *[Revoked]*

Clause 17.296: revoked, on 20 December 2021, by clause 315 of the Electricity Industry Participation Code Amendment (Code Review Programme) 2019.